

A concept of pusher - barge coupling device of two-segment ship for inland waterways and coastal service

Czesław Dymarski, Assoc. Prof., D.Sc.

Rafał Rolbiecki, M.Sc., Eng.

Gdańsk University of Technology

ABSTRACT

This paper presents design assumptions and a constructional concept of the device for coupling the pusher and hotel barge of two-segment inland waterways and coastal ship. The presented device makes it possible to reach either stiff connection or mutually controlled inclination of both segments against each other, which greatly improves the ship's manoeuvrability and thus safety of navigation especially on narrow and meandering waterways.

Keywords : ship devices, hydraulic drive and control

INTRODUCTION

The concept of two-segment passenger ship split into a propulsion unit and hotel unit has many advantages. It makes it possible to design a much larger push-train adjusted to sailing along a given river-bed, as compared with a single hull of similar dimensions.

Another important advantage of it is an improvement of manoeuvrability and this way increase of safety of navigation especially through narrow river-beds, available due to possible mutual inclination of coupled segments of the ship. Despite the mentioned advantages of such solution its practical application is to a large extent limited because of lack of a suitable device for coupling both the ship segments. One of the concepts for solving the problem is presented below.

DESIGN ASSUMPTIONS

Approaching to elaborate the drive and control of the coupling device for segments of inland waterways push-train, the authors have based on the following design assumptions :

1. For the device hydrostatic drive has been selected,
2. The hydrostatic drive of both units of the device, namely : that of main coupling cylinders and that of bolt-removing cylinders, should be independent on each other. It results from that both units have to be permanently fastened to different segments.
3. Both hydraulic units are independent on other ship devices. The assumption may be changed in the course of elaboration of technical design of both segments when detail information on kinds and location of other devices is available. In the phase of conceptual design to assume that it is not possible to supply them from hydraulic systems of other devices, is more safe.
4. Elements applied to the system should be typical and manufactured by recognized producers so as to ensure their high reliability in service, easiness of purchase and replacement at a moderate cost.
5. Starting the device should be effected in the state of no load applied to it or in such a way as to avoid sudden loads exerted on the ship energy network.

6. Control of operation of both units of the device should be carried out from the ship control centre.
7. The demanded angle of mutual lateral inclination of the segments, α , amounts to about 12°
8. The possible mutual angular displacement in the vertical plane, of the coupled segments, β , amounts to $\pm 3^\circ$
9. The possible mutual linear displacement in the coupling of both hulls amounts to $\Delta h = \pm 25$ mm
10. Local hand control, especially fast uncoupling the push-train segments in situation of emergency, should be ensured.

DESCRIPTION OF THE SOLUTION

The arrangement of elements of the device is shown in Fig.1 on the background of the ship segments, and additionally in Fig.2 in the axonometric projection.

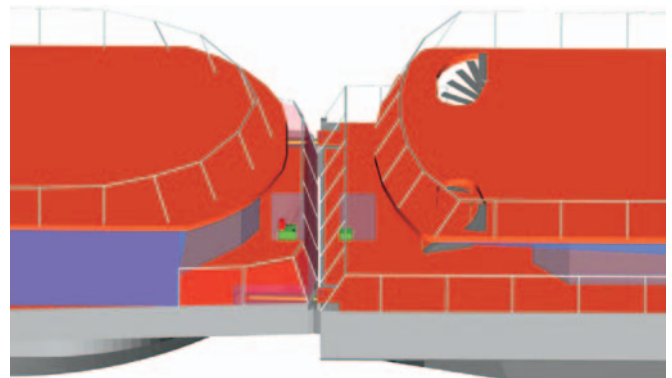

Fig. 1. Coupled segments of the ship. To the left –pusher; to the right –barge. Fragments of the deck above the coupling device units are presented as transparent .

The device is composed of two pairs of typical hydraulic cylinders of single piston-rod. Two larger coupling cylinders are placed horizontally in the bow part of the ship about 7.4 m apart. They serve for keeping both push-train segments in a strictly determined position to each other. The cylinders as such are fastened to the pusher hull in a way which makes certain angular displacements in both planes, i.e., horizontal and vertical, possible. In a similar way are fastened the piston-rod eyes to the hull of the pushed segment, i.e. the hotel barge.

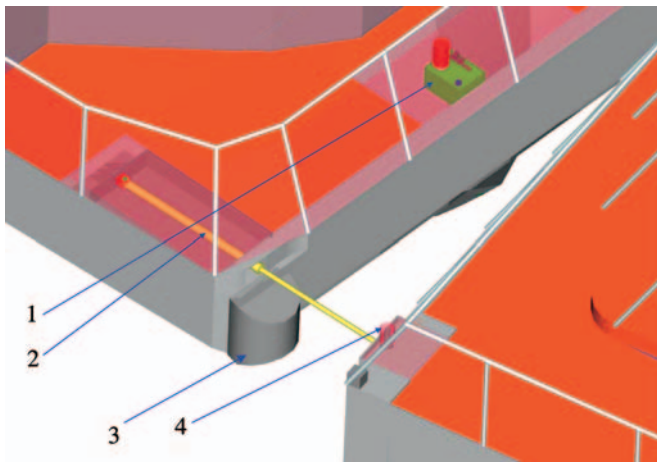

Fig. 2. A view over the segments which are parted by the angle of 12 deg. Notation: 1 - hydraulic supply unit of main cylinders, 2 - hydraulic coupling cylinder, 3 - fender, 4 - cylinder for removing the bolt from the piston-rod eye of the coupling cylinder (see Fig. 3). Fragments of the deck above the coupling device units are presented as transparent.

To limit values of mutual displacements of both the hulls in the place of their coupling, suitably shaped body lines of the hulls in that region were proposed. The convex cylindrical fender of the pusher enters the similarly formed socket of the barge, which can be clearly observed in Fig.2.

However it should be mentioned that the above proposed hull form is presented only as an alternative out of many other possible. In this case an important thing is to prevent the device (cylinders) against large random transverse loads due to e.g. very rough weather conditions. During normal service when the push-train segments are situated along common axis both the coupling cylinders can be hydraulically cut-off and serve only as permanent connecting rods which this way link both the ship segments almost rigidly. By this time the hydraulic supply system can be switched off, or in the case of application of a hydraulic accumulator – be on standby.

The inclination manoeuvre of the segments requires only oil to be delivered to only one of the cylinders. Due to location of the cylinder eye in the cylindrical „fender” axis the length of the non-operating cylinder remains unchanged during execution of the manoeuvre.

The hydraulic supply system of the coupling cylinders will be equipped with overflow (safety) valves which have to be so adjusted as to protect the cylinders against overloading, especially resulting from axial compression, and this way to avoid a danger of their buckling. The way in which the coupling cylinders and the bolt - removing ones are fastened, is more precisely shown in Fig.3. Each of the bolt - removing

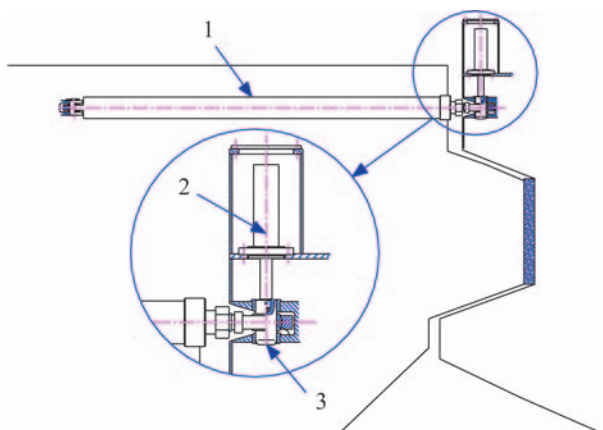

Fig. 3. The coupling unit of the ship segments. Notation: 1 - coupling cylinder, 2 - bolt-removing cylinder, 3 - removable bolt of piston-rod eye.

cylinders is placed in a cylindrical casing on the deck of the pushed segment directly over the point of the fastening of the coupling cylinder eye. The bolt-removing cylinders are of a flange type. The piston-rod of each of the cylinders is rigidly connected with the bolt 3 of the main cylinder's eye. The bolt led in special sleeves can be axially shifted within the range which makes it possible to disconnect the main cylinder eye completely. Hence, if disconnection the push-train segments is necessary it is sufficient to set the distributor in such a way as to make oil flowing under pressure to the auxiliary cylinders, that will bring about the bolts shifting out of the eyes of the coupling cylinders.

As the discussed auxiliary cylinders have to be installed on the pushed segment, their hydraulic supply unit should be also placed on that segment, but its starting and control operations should be also executed from the pusher, if possible. To this end, application of a relatively simple hydraulic unit with small hydraulic accumulator and electrically controlled distributor, is provided for.

DESCRIPTION OF THE DRIVE AND CONTROL OF THE DEVICE

Concepts of the hydraulic drive and control of both above mentioned units of the coupling device, elaborated on the basis of preliminary calculations, are presented below.

The unit of the coupling cylinders

The schematic diagram of the unit of hydraulic drive and control of coupling cylinders is presented in Fig.4.

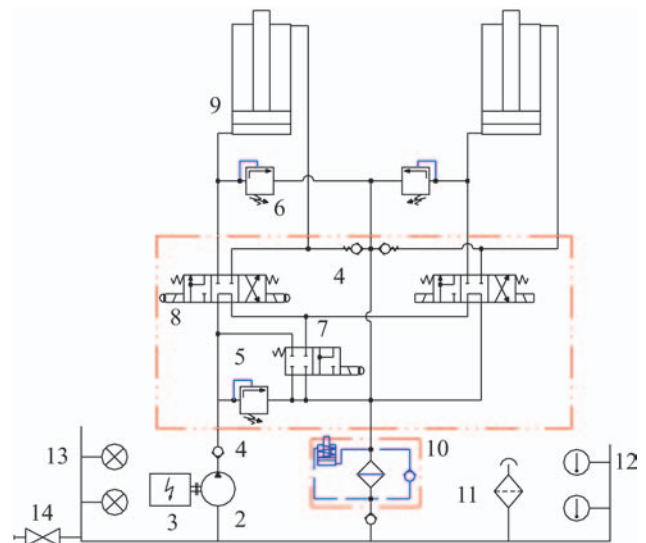

Fig. 4. Schematic diagram of the unit of hydraulic drive and control of the main coupling cylinders of the coupling device

The unit is equipped with the oil tank (1). The constant capacity pump (2) driven by the asynchronous electric squirrel-cage motor (3) sucks in oil from the tank and pumps it through the check valve (4) to the pipe connected with the overflow valve (5), the four-path two-position distributor (6) as well as the four-path three-position distributor (7).

The overflow valve (5) serves as a safety valve, i.e. it prevents the unit from an excessive increase of pressure. The distributor (7) makes it possible to connect the supply channels of both distributors (8) with the outflow pipe, that is desirable during the coupling and uncoupling operations of both segments, as discussed further.

The distributors (8) serve to control operations of the coupling cylinders (9) by directing working oil flow to appropriate

chambers of the cylinders. In the central position the distributor cuts off hydraulically both chambers of the cylinder and simultaneously connects the supply channel with the outflow pipe. This is favourable as it makes it possible to maintain the set position of the cylinder's piston and this way the mutual angular position of the coupled push-train segments, simultaneously unloading the pump, as well as to start up the motor and pump without loading. Switching-over any of the distributors (8) to the right results in connection of both chambers of the cylinder cooperating with it, to oil supply, and makes the cylinder's piston-rod moving out. It results from different working areas of the piston on both its sides. Switching-over the distributor to the left connects the piston-rod chamber of the cylinder to oil supply, and the piston-rod -free chamber - to the outflow, that makes the piston -rod moving into the cylinder. Velocities of both the mentioned movements would be approximately the same. The expected working loads of the cylinders would not be identical in both directions. Compressive loads would be greater. It should be mentioned that the selection of the cylinders was based on the buckling strength condition which made to apply somewhat greater diameters of piston-rod and cylinder necessary, as well as resulted in working pressure lowering. These factors made the application of such distributors as those of the kind (8), reasonable.

The pipes which deliver oil to the piston-rod - free chambers of the cylinders are connected with the overflow valves (6) which have to prevent the cylinders from excessive loading which could happen in the event of catching the pushed segment on an obstacle when the piston-rod of the cylinder is pull-out at the central position of the distributor (8). In this case, a sudden rise of loading and resulting increase of oil pressure would force the considered valve to open and the piston -rod to pull-in reducing this way the risk of its buckling and mitigating dynamic loads on the device and ship. In order to prevent - during the described situation - arising the under-pressure and cavitation phenomena in the cylinder piston-rod chamber, in the oil pipes leading to the chambers are installed check valves which make it possible to deliver oil from the outflow pipe to the mentioned chambers.

At the end of the outflow pipe are installed the check valve and the oil filter (10) equipped with a by-pass valve and indicator of contamination level of the filter.

The oil tank is fitted with the inflow filter (11), temperature gauge (12), low and high oil level indicators (13) as well as the drain valve (14).

When uncoupling the ship segments has to be urgently executed it is necessary first to switch over the distributor (7) to the left and both the distributors (8) to the right. It will make both the chambers of the main cylinders to be connected with the outflow pipe, and this way the cylinders to be unloaded, which will help in fast pulling out the bolts by means of their cylinders located on the hotel segment.

The unit of the bolt-removing cylinders

The drive and control unit of the bolt-removing cylinders is shown in Fig.5. In the unit is installed the small oil tank (1) and two pumps, one of which, (2), is driven by the asynchronous squirrel - cage motor (4), and the other, (3), - by hand. Both the pumps are connected with the pump main through the cut-off valves (5). With the pump main the following equipment elements are connected :

- ✦ the overflow valve (6) which serves as safety valve
- ✦ the small gas-hydraulic accumulator (10)

- ✦ the pressure control (11), which controls switching-on and - off the motor (4), the pump (2), depending on a value of oil pressure in the accumulator
- ✦ the pressure gauge (14)
- ✦ the two-path two-position distributor (7), which is usually closed and ensures tight cutting the accumulator off the remaining part of the system.

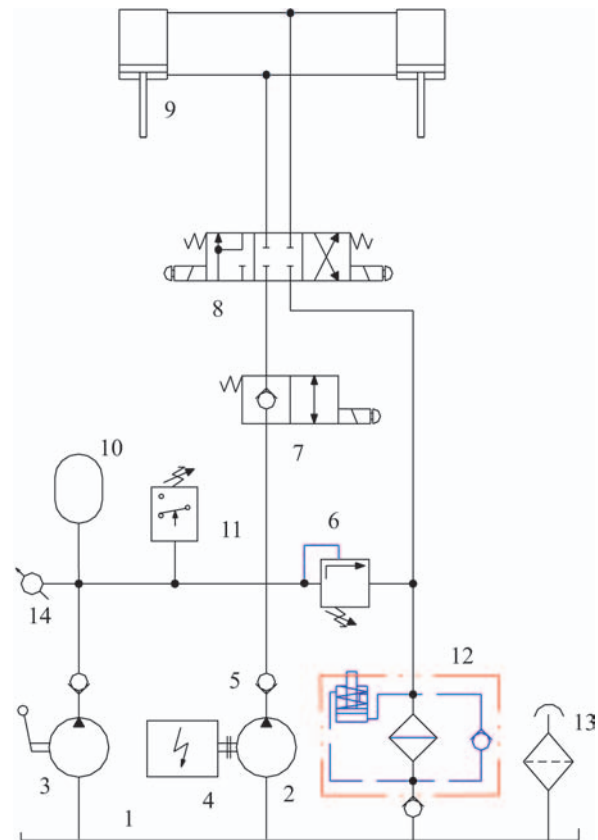

Fig. 5. Schematic hydraulic diagram of the drive and control system of the bolt-removing cylinders of the coupling device .

The switching-over of the distributor (7) to the left realizes connection of the accumulator with the four-path three-position distributor (8) intended for the operational controlling of the bolt-removing cylinders (9). Shifting the slider of the distributor (8) to the left makes the piston-rod chambers of the cylinders to be connected with oil supply, and the piston-rod-free chambers - with the outflow, and the piston-rods pulling out, which is associated with the removing of the bolts out of the eyes of the main cylinders and the uncoupling of the push-train segments. Shifting the slider of the distributor (8) to the right connects both the chambers of the cylinders with oil supply and forces the outside movement of the piston-rods, which is associated with the inserting of the bolts into the eyes of the main cylinders and the coupling of both the push-train segments.

In the outflow pipe the oil filter (12) and the cut-off valve (5) is installed. The oil tank is fitted with the inflow filter (13).

The bolt-removing cylinders applied in the system and the way of their supplying require a very small amount of oil for realization of their task. For that reason the oil pump and its driving motor can be of a small power. The gas-hydraulic accumulator applied in the system makes it possible to lower power and size of the pumping set and to store suitable amount of energy necessary for switching -over the cylinders several times. The hand-operated pump makes it possible to charge the accumulator within a short time and to switch over the cylinders also when electric energy is not delivered.

CONCLUSIONS

- The presented concept of the coupling device of the push-train segments of the inland waterways and coastal ship, elaborated as a result of the analysis of many alternative solutions, has been deemed optimal.
- It makes it possible to realize the demanded tasks, being relatively simple and based on application of typical and relatively inexpensive elements. Hence its initial, maintenance and operational costs will be low.
- Another its favourable feature is that when the ship sails with uninclined segments the cylinder piston-rods are entirely pull into the cylinders thus the working surface of the piston-rods is prevented from exposure to atmosphere and contamination agents and the whole pusher-barge train becomes more stiff and capable of transferring greater loads.
- It should be mentioned that for the reason of visualizing the concept a few necessary changes were introduced to the upper part of the pusher for which the device in question was designed.
- The solutions presented in Fig. 6 and 7 should be considered as alternatives out of many other possible.
- The presented driving systems of both units are favourable from the point of view of their service, and more energy-saving, as compared with other devices of the kind. The set of the coupling cylinders operates only during manoeuvres of mutual inclination of ship segments, and is put in operation without any loading. During remaining service time the pump is switched off and both chambers of the cylinders are hydraulically cut-off, maintaining their set position.
- The set of bolt-removing cylinders practically remains all the time free of switch-over operations, being on standby, and only supplementing from time to time oil losses to the accumulator. By an appropriately programmed sequence of switch-over operations of the distributors in such a way as to first connect both chambers of the cylinders with the outflow and only next to supply the bolt-removing cylinders in order to uncouple or couple the ship segments, this operation becomes much easier and safer.
- In the case when the ship is equipped also with other hydraulic devices a simplification of the systems by using common tanks and pumps may be possible.

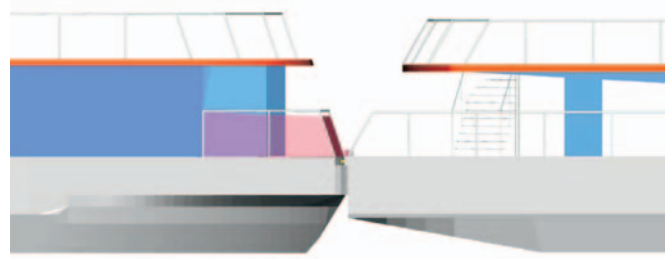

Fig. 6. Side view over the coupled ship segments .

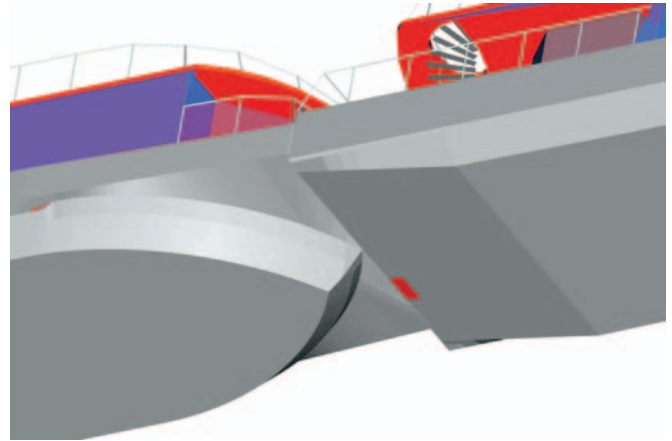

Fig. 7. View from below over the coupled ship segments .

BIBLIOGRAPHY

1. Cz. Dymarski: *A conceptual design of the coupling device for push-train segments of inland waterways and coastal ship : Part I – A general concept of the device, Part II – A concept of the hydraulic drive and control of the device* (in Polish). Research report no. 144/E/2004, Faculty of Ocean Engineering and Ship Technology, Gdańsk University of Technology. Gdańsk, 2005
2. Firms : Rexroth, Hydroster, Cantoni Group : *Product catalogues and web pages*
3. *General arrangement plans of both segments of the ship* Hołowko W., Michalski J.P., Rosochowicz K.: *A design concept of ecological tourist – passenger ship intended for Berlin-Królewiec (Kaliningrad) inland waterway service*. Gdańsk, 2006
4. *Body lines of both segments of the ship*, Research report EUREKA! Gdańsk, 2005/2006



Photo : Arkadiusz Łabuć