

# A framework for onboard assessment and monitoring of flooding risk due to open watertight doors for passenger ships

Pekka Ruponen<sup>a,b,\*</sup>, Jakub Montewka<sup>b,c</sup>, Markus Tompuri<sup>a</sup>, Teemu Manderbacka<sup>a,d</sup>, Spyros Hirdaris<sup>b</sup>

<sup>a</sup> NAPA, Finland

<sup>b</sup> Department of Mechanical Engineering, Marine Technology, Aalto University, Finland

<sup>c</sup> Faculty of Mechanical Engineering and Ship Technology, Department of Ship Design, Gdansk University of Technology, Poland

<sup>d</sup> VTT, Finland

## ARTICLE INFO

### Keywords:

Maritime risk and safety  
Watertight doors  
Vulnerability to flooding  
Accident susceptibility

## ABSTRACT

Post-accident safety of ships is governed by damage stability, affected by watertight subdivisions which limit accidental flooding. This is important for passenger ships with watertight doors (WTDs) often fitted in the bulkheads. Awareness of the ship flooding risk due to open WTDs and the conditions under which the associated risk level changes are prerequisites for proactive risk mitigation.

Accident risk is often expressed as a combination of accident likelihood and its consequences. Current solutions for flooding risk mitigation often treat these elements separately, or the adopted metrics are based on quantities not allowing proper active control of risk.

In this paper an attempt is made to fill this gap by introducing a novel concept for rapidly assessing the flooding risk onboard passenger ships, accounting for the two dimensions of flooding accidents. The likelihood part is based on the complexity of surrounding traffic, operational conditions, and human reliability assessment. The consequences are based on precalculated probabilistic damage stability results of ship survivability.

The presented case studies indicate that active monitoring of flooding risk can increase the crew's situational awareness of the effect of open WTDs on the flooding risk, thus positively influencing the safety culture onboard the ship.

## 1. Introduction

Extensive flooding and subsequent capsizing of a passenger ship is one of the accident types that leaves the crew limited time to respond, and which may result in a large number of fatalities [1–3]. To this end appropriate risk models are needed, provided that they focus on the right parameters, and can deliver the right information at the right time.

The literature on this subject is quite broad and is divided into three main streams: (a) strategic risk assessment and management, including risk-based ship design [1–6,12–17]; (b) operational risk evaluation and management [7–11]; and (c) waterway complexity planning and associated risk mitigation [18–22]. To ensure ship safety, it is essential to properly address the relevant hazards and associated risks at both the design and operational stages [17,18].

For passenger ships, in the context of operational risk and risk-based ship design, two terms are used to describe accident risk: (a)

susceptibility to the accident and (b) vulnerability in an accident (e.g. ship flooding), which follows conventional definition of risk as a combination of accident likelihood and consequences, [19–21]. This leads to risk mitigation measures aiming to prevent accidents, or to reduce their consequences [22,23]. The literature on risk of maritime transportation systems includes various risk assessment methods and tools that address these aspects independently, but rarely in a combined format [22,24]. A guideline on maritime risk assessment called the Formal Safety Assessment was approved by the International Maritime Organization (IMO) in 2002 [25,26]. However, various criticisms have been made of its details, especially regarding the definition of risk and the manner in which it is translated into monetary terms, [26–30]. Moreover, the definition of risk adopted therein does not correspond well to the recent trends in scientific and industrial domains, where the focus is on uncertainty quantification rather than precise quantification of the probability and consequences, mainly due to vague and incomplete data, [31,32]. A

\* Corresponding author.

E-mail address: [pekka.ruponen@napa.fi](mailto:pekka.ruponen@napa.fi) (P. Ruponen).

<https://doi.org/10.1016/j.ress.2022.108666>

Received 10 March 2022; Received in revised form 7 June 2022; Accepted 10 June 2022

Available online 11 June 2022

0951-8320/© 2022 The Authors. Published by Elsevier Ltd. This is an open access article under the CC BY license (<http://creativecommons.org/licenses/by/4.0/>).

much wider, more detailed picture of both the risk fundamentals and the associated uncertainties is therefore needed, based on data that better reflect the governing mechanisms of the described processes, allowing effective risk mitigation measures, especially for the operational risk evaluation, focusing on accidents resulting in life loss, such as ship flooding, [32–37].

The risk of ship flooding is a complex topic and known to be affected by numerous factors, with watertight door (WTD) status being one of those. The watertight doors are often mounted in the bulkheads dividing the ships into watertight (WT) compartments to limit the flooding extent in the event of an accident, so that sufficient stability and reserve buoyancy are achieved. Keeping these doors open longer than necessary for safe passage through them by crew compromises the watertight integrity of the ship. For example, in the *Stena Nautica* accident in 2004, the collision damage was limited to a single WT compartment. However, because of several open WTDs, the flooding progressed to several undamaged compartments, endangering ship stability [38]. On the other hand, if work requires crew to frequently pass through the WTDs, there is a serious risk of injury when doors are frequently opened and closed, [39]. Monitoring the vulnerability to flooding due to open WTDs provides the crew an insight into the associated risks and strives towards safer operation of the ship [40]. Subsequently [41] has recently called for increased awareness of the risks associated with the operation of WTDs.

Monitoring the current WTD status is standard practice [42]. Normally at sea, all watertight doors should be closed, with so-called Category “C” doors opened only briefly for the safe passage of people. However, so-called Category “B” doors may be kept open for longer periods during navigation if work in the vicinity of the door requires it, as specified in IMO Circ. 1564 [43]. Furthermore, existing ships may have Category “A” WTDs, allowed to be permanently open at sea based on a so-called floatability assessment, IMO Circ. 1380, [44]. An overview of this recent regulatory development, especially related to WTD categories, is given in [45]. However, successful closing of open WTDs can be prevented by the deformation of bulkheads and decks as a result of structural damage suffered in the course of collision or grounding, [43,44]. Furthermore, because WTDs have up to 60 s to close according to SOLAS Regulation II-1/13.5.1, [46], the risk of progressive flooding is notable when watertight doors are open in adjacent transverse watertight bulkheads. Consequently, automatic real-time monitoring of the flooding risk due to open WTDs is needed.

Currently, there are solutions for monitoring a ship’s vulnerability to flooding [47–49], which often automatically activates a decision support mode if flooding is detected, [48]. Their main aim is to increase the crew’s awareness of the risks and safety of a ship [47]. An overview of recent improvements to ship stability and safety in damaged conditions through operational measures was presented in [50], and some further developments are reviewed in [51]. The concept of operational vulnerability of passenger ships to flooding was first discussed in [47, 52]. This research also introduced prototype onboard software for the assessment of the vulnerability due to open WTDs, based on probabilistic damage stability calculations. The results were promising, but the required computations were considered too extensive for practical use onboard. After all, this kind of a system needs to be reactive to any sudden change, either in the watertight integrity or in the operational environment. Consequently, a simplified approach for monitoring WTD status, based on the number of affected compartments, was introduced in [48]. However, this method does not properly account for the locations of the open doors and their combined effect on the vulnerability to flooding. Similarly, in [49] a monitoring tool is described based on a live floatability assessment, following the previous IMO recommendation for category “A” WTDs, [43]. However, because this approach assumes that open WTDs can be closed rapidly, and that progressive flooding is limited to the WT compartments adjacent to the damaged compartment, the flooding risk can often be underestimated.

The study on risk due to the WTDs within the EMSA III project [53]

led to a recommendation, issued by the Cruise Ship Safety Forum (CSSF), for assessing the vulnerability due to open WTDs, [54], which is a major step towards the safer operation of passenger ships. The suggested methodology is based on the so-called simplified A-index as a measure of survivability. Most of the required data is obtained from manual input on board a ship, but the recommended stability calculations need to be done remotely, in the emergency control center ashore. Such monitoring can result in a notable decrease in vulnerability to flooding, as reported by [51], but for the onboard use, such a system needs to automatically monitor the situation and rapidly perform the necessary calculations onboard.

A natural extension of the existing vulnerability assessment solutions would be a framework for the operational assessment of flooding accident susceptibility of passenger ships resulting from collision or grounding, accounting for relevant contributing factors. Continuous assessment of both ship vulnerability and susceptibility is an element of a dynamic safety barrier that tends to increase the crew’s situational awareness and ship safety via the safe operation of watertight doors, as recently elaborated and demonstrated in [23]. Despite combining susceptibility with vulnerability, the solution proposed in [23] does not offer any novel or principles-driven approach to monitor the safety of ship in a proactive manner accounting for relevant and observable factors. Instead, it utilizes statistics, which in this case are not applicable, as they do not reflect actual operational conditions. Therefore, another solution for the estimation of accident susceptibility is needed, one which is user-oriented, and which reflects the operational principles of a specific ship. The ship susceptibility to an accident is conventionally assessed, either in the literature or in practice, with the use of various types of proximity indicators, such as distance and time to the closest point of approach (DCPA, TCPA) or ship domains [55]. However, none of these account for the actual mechanism that governs and quantifies the accident occurrence through the human reliability assessment, which is claimed to be the major driving factor for the accidents [56–59].

This paper introduces a framework for the rapid assessment and real-time monitoring of operational flooding risk for a passenger ship. The methodology accounts for measurable risk-affecting factors and mechanisms governing the process of an accident and its aftermath [60]. To this end, data on surrounding maritime traffic and bathymetry are utilized, since these are known to affect the reliability of a navigator on board the ship, and thus also the accident probability. In addition, the results of extensive and representative calculations of damage stability for flooded ships in various damage scenarios are used to estimate the expected consequences. Finally, experts’ judgment and heuristics are applied to bind together the susceptibility and vulnerability into a risk model. The applicability of the framework is demonstrated by a case study.

The paper is structured as follows: a framework for flooding risk assessment is introduced in Section 2, while Section 3 describes adopted methods and models that the framework encompasses. The applicability of the framework is demonstrated in Section 4, and discussed in Section 5, while Section 6 concludes the paper.

## 2. Framework for flooding risk estimation for passenger ships

### 2.1. Definitions

The previously developed tools for risk assessment onboard passenger ships have focused solely on the reduced survivability in the event of a flooding accident attributed to open watertight doors. A more comprehensive assessment should also account for the actual operational environment, such as nearby maritime traffic and bathymetry in the vicinity. Such a method may lead to a more holistic approach that allows for active risk mitigation measures [61–64]. To this end, development of the new approach can begin by using the commonly applied framework for the risk-based design of naval ships [65,66]. This

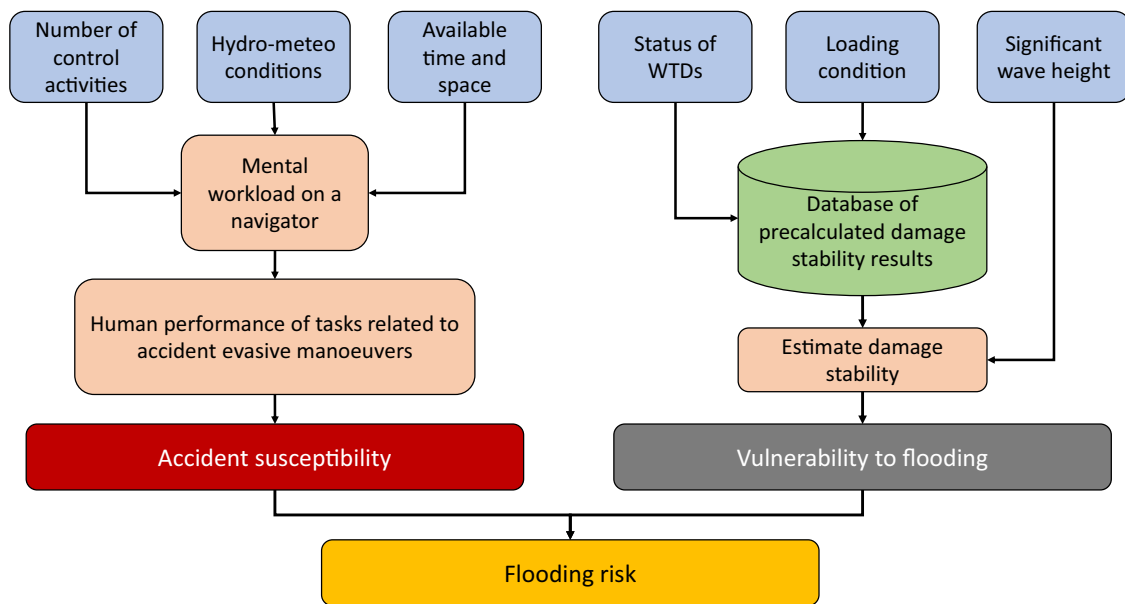

Fig. 1. A causal chain explaining the relation between the input data – mechanism – output.

framework defines the probability of navy ship survival as:

$$P_s = 1 - P_h P_{k|h} \tag{1}$$

where  $P_h$  is the probability of being hit (by a weapon), i.e. susceptibility, and  $P_{k|h}$  is the probability of a kill given the condition of being hit, i.e. vulnerability. The navy approach can also consider recoverability due to actions by the crew, such as closing open doors or pumping [65].

The concept is a useful basis for development of vulnerability and safety assessment onboard passenger ships. The probability of survival can be presented as:

$$P_s = 1 - P_a P_{l|a} \tag{2}$$

where  $P_a$  is probability of an accident (collision or grounding), accounting for the operational area (bathymetry) and nearby traffic, and  $P_{l|a}$  is probability of loss (sinking/capsizing) in the event of a flooding accident, accounting for the status of the WTDs and the prevailing sea state. The recoverability is not considered, since it is a conservative assumption, and simplifies the calculations. Naturally, in normal conditions the open WTDs can be closed rapidly, but in practice this may not always be possible, e.g. due to structural deformation caused by a collision or grounding [67–70].

In a classical risk-informed design approach, both susceptibility and vulnerability are usually described in a probabilistic fashion, which for the purpose of ship design is sound and correct. However, for operational purposes, where the focus is on identification of dangerous situations and taking evasive actions, such a probabilistic approach is insufficient. The main reason is that a purely probabilistic risk index, without any reference to actual operational practices, does not distinguish between situations, and thus does not inform the actions to be taken to reach the desired level of risk. Therefore, another approach shall be taken, which defines both susceptibility and vulnerability in a way that informs the end-users on the available decisions in due time, while also accounting for the inherent uncertainty.

Susceptibility is defined as “the lack of ability to resist some extraneous agent” [71]. In maritime settings, the extraneous agent is a set of factors which increase the mental workload of a navigator, and which thus deteriorate his/her performance, as depicted in Fig. 1. The susceptibility of a ship to an accident describes qualitatively how likely it is for the navigator to make a mistake which ultimately leads to an accident, in a given traffic and environmental situation, [71]. To evaluate

susceptibility, human reliability assessment techniques were applied, accounting for factors affecting navigator reliability such as the number of control activities, available time and space, and hydro-meteorological conditions, [72,73]. For modelling purpose these factors are grouped into three categories: environment complexity (visibility), traffic complexity (type and number of target ships the navigator needs to handle) and waterway complexity (proximity to shallows and their relative orientation with respect to the navigator’s ship). The final accident susceptibility is expressed as a qualitative index, based on quantitative assessments, intended to reflect the difficulty that a given situation presents to a navigator. The higher susceptibility, the more likely it is for a navigator to make an error.

The susceptibility index can be used to distinguish dangerous situations from moderately hazardous and non-hazardous. Therefore, the susceptibility index is used here for comparative purposes, and does not take numerical values. In the operational assessment of flooding risk such an approach is deemed sufficient since it aligns with the onboard navigational practices, where the navigator should detect and avoid collision situations, rather than assigning the probability of a collision to the situation.

The vulnerability describes the severity of the consequences in the event of an accident, by estimating the decrease of survivability due to open WTDs. It is calculated based on a probabilistic damage stability framework, as shown in Fig. 1. Like the susceptibility, it distinguishes between various accident scenarios by assigning a level to those scenarios, ranging from low, moderate, high, and very high. Also like the susceptibility, in this paper the vulnerability index is of a qualitative nature. It is, however, based on extensive computations.

## 2.2. Flooding risk framework

By using heuristics to bind together the susceptibility and vulnerability indices, a qualitative risk index is obtained to inform the user about the risk of flooding and the need to take risk mitigation measures. The logical flow from input data – mechanisms – output data adopted by this framework is shown in Fig. 1.

The flooding risk index is expressed by the following equation, adopted from the risk-matrix idea, [58]:

$$RI = AS + VL \tag{3}$$

Where AS refers to accident susceptibility, and VL denotes accident

**Table 1**  
A generic framework evaluating values of risk index based on susceptibility and vulnerability.

		Susceptibility Index				
		Negligible1	Low2	Moderate3	High5	Very high7
Vulnerability Index	Negligible – 1	2	3	4	6	8
	Low – 2	3	4	5	7	9
	Moderate – 3	4	5	6	8	10
	High – 5	6	7	8	10	12
	Very high – 7	8	9	10	12	14

**Table 2**  
Risk index for conditions of good visibility and average sailing conditions (I – negligible, II – low, III – moderate, IV – high, V – very high), based on Table 1 and Eq. (4).

		Susceptibility Index				
		Negligible	Low	Moderate	High	Very high
Vulnerability Index	Negligible	I	I	II	III	III
	Low	I	II	II	III	IV
	Moderate	II	II	III	III	IV
	High	III	III	III	IV	V
	Very high	III	IV	IV	V	V

vulnerability. The indices used to describe AS and VL are expressed on a linear scale as depicted in Table 1. The non-uniform distances between the consecutive indices are assumed to account for the anticipated non-linearities in the governing mechanism behind the AS and VL, as elaborated upon in [62]. Ultimately, the risk indices (RI) are assigned to one of the following classes: *Negligible, Low, Moderate, High, Very high*, as shown in Table 2. For the purpose of RI assignment, the following set of mapping functions (MF) is defined:

$$Set1 = \begin{cases} MF_1 \text{ if } RI = (2, 3), \text{ then } RI = \text{Negligible} \\ MF_2 \text{ if } RI = (4, 5), \text{ then } RI = \text{Low} \\ MF_3 \text{ if } RI = (6, 7, 8), \text{ then } RI = \text{Moderate} \\ MF_4 \text{ if } RI = (9, 10), \text{ then } RI = \text{High} \\ MF_5 \text{ if } RI = (12, 14), \text{ then } RI = \text{Very high} \end{cases} \quad (4)$$

In the above expression the mapping functions may vary depending on the hydro-meteorological conditions and visibility, as demonstrated in [62]. The form of the mapping function can be specified by the ship operator; it can even vary from ship to ship, or from area to area. For the framework presented here, good visibility and average sailing conditions are assumed for the analyzed ship type, as reported in [63,64].

The color code used here to distinguish among the risk levels is adopted from the earlier works on the accident susceptibility framework described in [62], as well as the framework for the assessment of severity of an accident, called *Vessel TRIAGE*, elaborated in [74]. The color code aims at clear communication between all involved stakeholders in an emergency situation. It also enables easy and rapid communication of the flooding risk to the crew and other interested parties – e.g. personnel located in a shore-based control center.

For good visibility conditions, as presented in Table 2, the highest value of risk index is when a ship is exposed to hazardous encounters with other ships or land (high or very high susceptibility) and the vulnerability is also high or very high (numerous WTDs open). This means that in the case of an accident the consequences can be devastating. At the other end of the scale, a ship faces low risk index when she is safe from hazardous situations or moderately exposed to it with low index of vulnerability (no, or only a single, WTD open). For situations in-between susceptibility is assumed to range from moderate to high.

In regular ship operations a very high value of the risk index (BLACK) is considered a situation that should be avoided. This is because it leaves very little, or no, room for improvement in case of an accident and, therefore, considerably increases the chances of ship loss and fatalities.

In practice, the bridge crew is instructed not to allow such situations to develop.

At the opposite side of the scale, low risk index values (BLUE or GREEN) are considered target conditions, to be reached and preferably maintained during regular operation. A moderate risk index (YELLOW) tends to reflect normal operational conditions, while a high risk index (RED) is associated with dense traffic areas and/or numerous WTDs open.

Especially on older passenger ships, maintenance work may require several WTDs to be open for an extended period of time, causing a notable increase in the vulnerability to flooding. However, the risk is acceptable if the accident susceptibility is kept low. On the other hand, in the case of high accident susceptibility, even a single open WTD can pose significant risk.

A moderate risk level (YELLOW) is acceptable for longer periods only when forced by the operational environment or when temporary maintenance work requires open WTDs. Nevertheless, in the operation of passenger ships, the high risk level (RED) should be allowed only temporarily, e.g. when a WTD is opened for passage, when the ship sails close to shallow waters, or in a high traffic density area. Long periods of RED and BLACK (very high risk) situations should always be reviewed afterwards, with an aim to improve practices and to avoid such a situation in the future.

### 2.3. Technical requirements

The previous research on the effects of open WTDs on vulnerability to flooding, as reported in [47,48,53], provides a solid basis for a novel solution for systems assessing and monitoring flooding risk on board passenger ships. The key requirements for such a system are:

- rapid response, especially to a change in the WTD status or in the loading condition,
- automated assessment, without any manual user input,
- transparency and clear presentation of results, so that the crew understands the reasoning behind the current vulnerability level.

Furthermore, the system should be suitable for retrofit on existing passenger ships, designed according to previous regulations, including fully deterministic damage stability requirements. The benefits of vulnerability monitoring are much larger when the same tool is used fleet-wide, and the crew is familiar with the system, even when relocating to another ship.

Assessment of the current susceptibility and vulnerability levels requires input data from various systems on board the ship. Manual user input should be avoided to minimize the possibility for a human error, and to ensure reliable analysis in all conditions. The status (open/closed) of watertight doors is one important input, and these signals should be available from the automation system on all modern passenger ships. In addition, maritime traffic information provided by AIS (Automatic Identification System) and bathymetry data are required for accident susceptibility assessment. Data from AIS include the position, course, and speed of nearby vessels, and are used as input to a traffic complexity assessment algorithm. Bathymetric data is essential for waterway

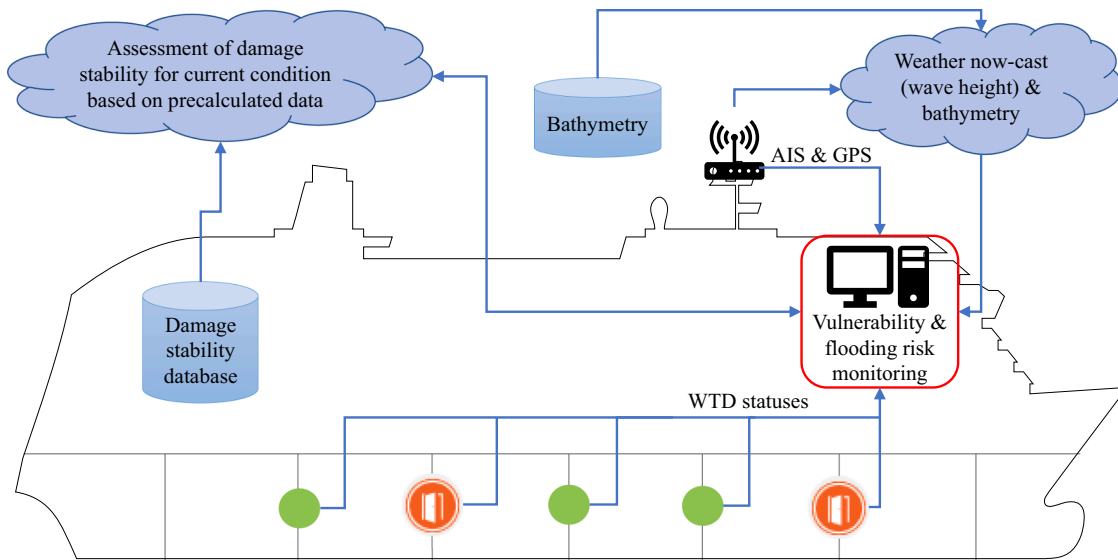

Fig. 2. Schematic presentation of information flows and calculations for monitoring the vulnerability to flooding due to open watertight doors.

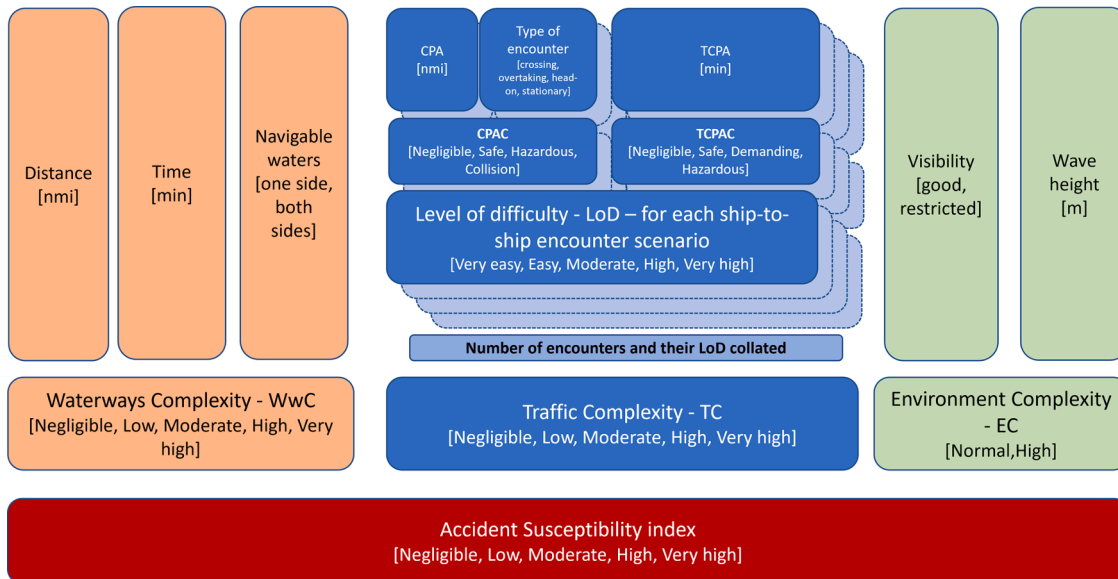

Fig. 3. Framework for accident susceptibility assessment for a ship in operation, [62].

complexity assessment, and can be fetched from the onboard nautical equipment, such as the Electronic Chart Display and Information Systems (ECDIS) or dedicated bathymetric databases, such as the General Bathymetric Chart of the Oceans (GEBCO<sup>1</sup>). Visibility data are used to assess the complexity of the environment. Finally, these three complexity types are combined using heuristics, in the form of an accident susceptibility framework as introduced and described in detail in [62].

The environmental conditions, especially related to the prevailing sea state, are more difficult to estimate. Previously, significant wave height was considered as a manual user input, [47]. However, this imposes the risk that the value is not properly given and/or updated. In the absence of a wave radar, weather forecasts and nowcasts are good options, with the significant wave height at the location of the ship being interpolated from this data. The downside of this approach is the

necessity of both a continuous internet connection and a cloud-based service evaluating the weather conditions.

The data transfer and calculation flow for the new approach on operational flooding risk via combined accident susceptibility and vulnerability to flooding indices is illustrated in Fig. 2. A cloud-based solution enables real-time monitoring of the flooding risk for a fleet of ships, and feedback from shore-based experts can be used to improve the practices onboard.

### 3. Methods

#### 3.1. Accident susceptibility

##### 3.1.1. Framework

The semi-qualitative framework for evaluating accident susceptibility for a ship in operation is based on both human performance and underlying factors. The literature on Human Reliability Analysis (HRA) presents an inverse relation between human performance and accident

<sup>1</sup> <https://www.gebco.net/>



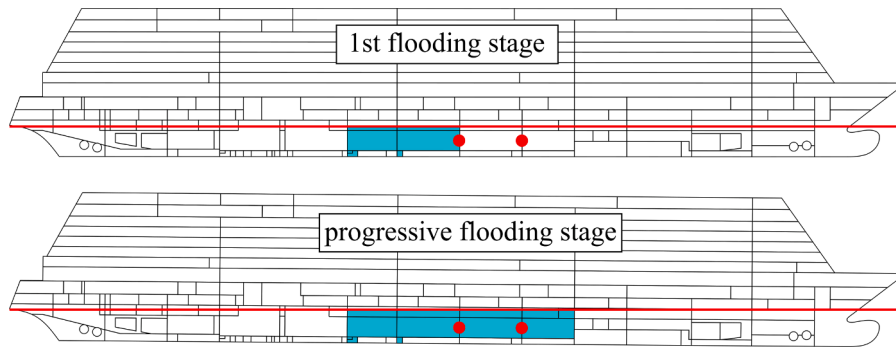

Fig. 4. Flowchart demonstrating process of accident susceptibility assessment, [62].

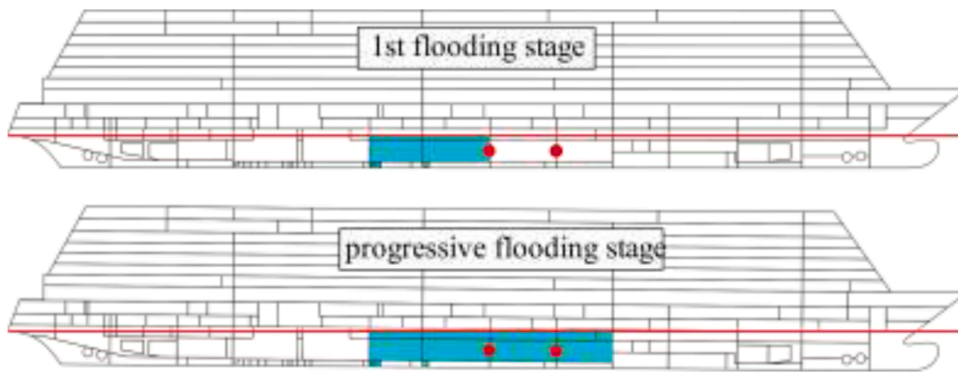

Fig. 5. Example of flooding stages of a two-compartment damage case with two open watertight doors (red circles).

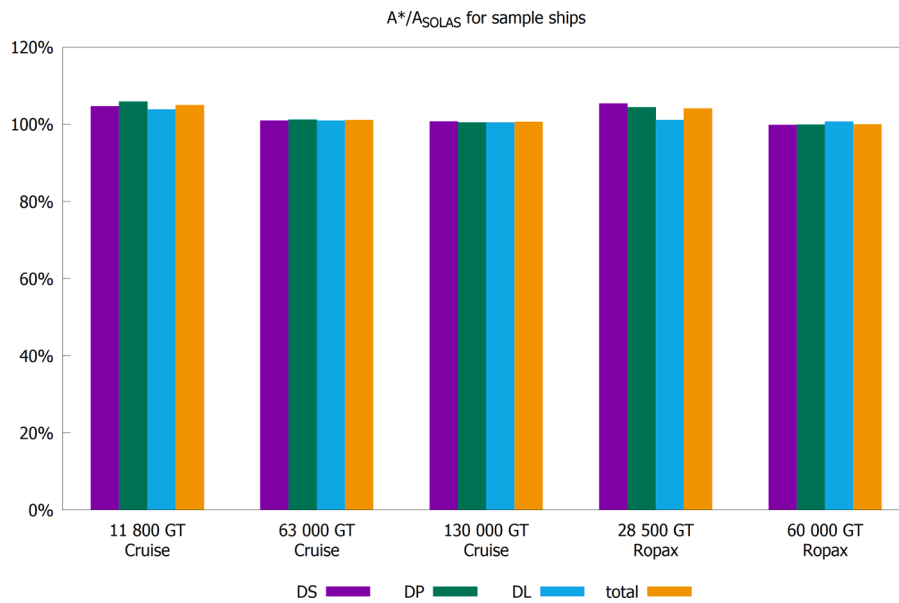

Fig. 6. Comparison of calculated  $A^*$  and the SOLAS Ch. II-1 regulatory index  $A_{SOLAS}$  for five sample ships for the SOLAS loading conditions (deepest subdivision draught DS, partial draught DP and lightest service draught DL) and the weighted total index.

probability [35,39]. Human performance is affected by so-called performance shaping factors (PSF). Two of these PSFs are considered in the accident susceptibility framework developed here: number of simultaneous tasks, and available time, [39,59,60]. Safety in ship navigation can be improved by ensuring an appropriate level of performance throughout the entire being analyzed; for example, safeguards could be put in place to shield the operator from the factors which degrade performance, or alternatively, the operator could be exposed to conditions

which improve performance.

The two PSFs considered here are known to influence the performance of a navigator conning a ship. These PSFs are governed by the following three distinctive characteristics of an encounter at sea: available maneuvering space with respect to navigable waters; number and types of encounters with objects on collision courses; and hydro-meteorological conditions, [43,45–47]. The higher the number of control activities that need to be performed simultaneously, or in a short

**Table 3**  
Main dimensions of the sample ships used in the comparison of attained subdivision index calculation methods.

Sample ship	Length (m)	Beam (m)	Subdivision draft (m)	Persons onboard
11 800 GT Cruise	115	20.0	5.30	480
63 000 GT Cruise	238	32.2	7.20	2 400
130 000 GT Cruise	310	40.0	8.50	4 500
28 500 GT Ropax	145	28.0	6.30	2 000
60 000 GT Ropax	215	32.0	7.10	2 800

**Table 4**  
Main parameters of the “FLOODSTAND B” cruise ship design.

Gross tonnage	63 000
Length over all	238.0 m
Beam, moulded	32.2 m
Design draft	7.2 m
Max. number of persons onboard	2 400

conditions, which require additional actions, such as monitoring and adjusting the response of the ship to wind and wave action or anticipating the effect of wind and wave action on evasive maneuvers.

Subsequently, the three distinctive characteristics of situations affecting a navigator’s workload and performance are referred to as complexities<sup>2</sup>, related to waterway, traffic and environment.

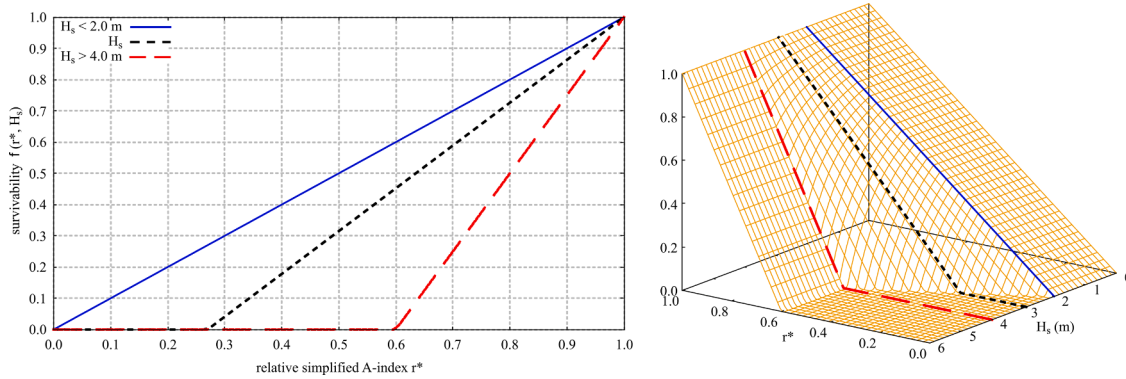

Fig. 7. A simplified approach to account for the effect of significant wave height on survivability, using Eq. (12).

Low	$VL \leq 0.05$
Moderate	$0.05 < VL \leq 0.10$
High	$0.10 < VL \leq 0.20$
Very high	$VL > 0.20$

Fig. 8. Suggested color coding and threshold values for the vulnerability level.

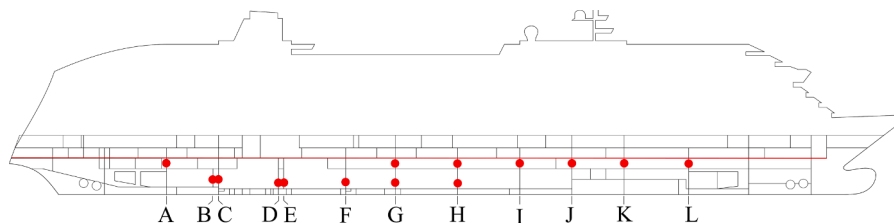

Fig. 9. A 63 000 GT cruise ship design “FLOODSTAND B” [82]; WTDs are marked with red circles, bulkhead deck with red line and transverse bulkheads are identified with letters A-L.

time span, and the smaller the maneuvering space available for the ship, the higher the workload. This in turn increases the probability of navigation errors and an accident happening. These chances are further amplified by the presence of unfavorable hydro-meteorological

By binding the three types of complexity together an accident sus-

<sup>2</sup> Complexity is understood here as “a measure of difficulty that a particular traffic situation will present to a navigator”, adopted from [59].

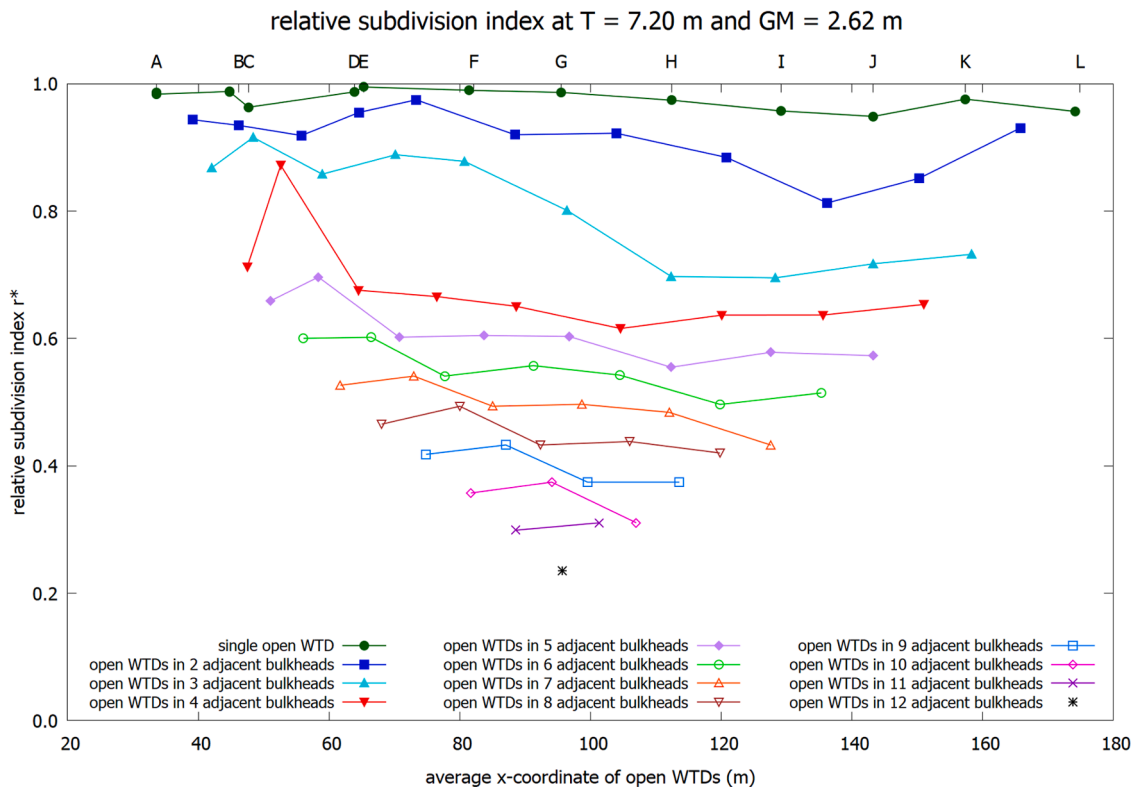

Fig. 10. Example of calculated relative index  $r^*$  values as functions of the average longitudinal location of the open doors for conditions with several open WTDs in adjacent transverse WT bulkheads of a cruise ship.

ceptibility index is developed, as depicted in Fig. 3.

$$AS = f(TC, WwC, EC) \tag{5}$$

Where AS refers to Accident Susceptibility, TC denotes Traffic Complexity, WwC stands for Waterways Complexity and EC means the environmental complexity. The AS indices are assigned to one of the following classes: Negligible; Low; Moderate; High; Very high. To this end heuristics and expert knowledge is adopted. The former is applied to develop the overall structure of the accident susceptibility index, while the latter is used to quantify the parameters applied to evaluate the index. The expert knowledge on navigational practices was gathered from several officers and captains of passenger ships through an online survey. It helped us to define and understand the boundary for the operational conditions of the ship that are found to be both regular and comfortable for the navigators, as well as those that are infrequent but challenging and affect the workload and performance of a navigator. The heuristics, survey and its results are explained in detail in our earlier work, [62].

The accident susceptibility indices are based on input parameters that are, to a large extent, quantitative (e.g. distance and time to navigable waters, proximity indices for collision situation, wave height), with few qualitative exceptions (visibility, availability of navigable waters, level of complexity with respect to the traffic situation). Since the literature supports the presence of compensation strategies for increasing complexity through individual differences and cognitive strategies or quality of equipment [52], the proposed framework allows for adjustments to the parameters of the complexity levels. For a detailed description of the susceptibility framework the reader is referred to our earlier work [62].

### 3.1.2. Waterway, traffic, environmental complexities

**Waterway complexity (WwC)** describes the mental workload exerted on a navigator by the need for monitoring a ship's track against bathymetry and adjusting her course and speed in proximity to shallow

waters as needed. The main governing factor for WwC is the time required to reach the shallow water, with a distinction made as to whether the water is restricted on one or both sides, [49]. WwC reaches high values in situations where a ship navigates through waters enclosed on both sides. It achieves moderate values when one side of the ship remains open, and it takes negligible values if the time to reach shallow water is long, giving a large maneuvering space for the ship.

**Traffic complexity (TC)** reflects the navigator's workload induced by the type and number of encounters the operator needs to handle and the time available for the task. Four types of encounters are accounted for in this framework: crossing, head-on, overtaking and encounters with stationary objects. For each type, the classes of proximity indicators (CPA, TCPA) are defined. Traffic complexity is defined by the following parameters:

- 1 the closest distance between two encountering ships (CPA),
- 2 the time to reach the closest distance from the present time instant (TCPA),
- 3 level of difficulty, which is a combination of CPA and TCPA,
- 4 type of encounter,
- 5 the number of target ships and level of difficulty.

**Environment complexity (EC)** attempts to describe the effect of relevant hydro-meteorological features on the mental workload of a navigator. For this framework only the anticipated effect of restricted visibility on the accident susceptibility index is accounted for in a semi-qualitative manner. This is mainly based on the recommendations of Cruise Ship Safety Forum - [49] - and the input of experts as reported in our earlier work [62]. Another factor that may affect accident susceptibility is wave height, which for the purpose of this study is taken as a constant (and therefore does not increase the workload). This is acceptable as the ships taken as the passenger ships taken as case studies here usually operate in favorable weather conditions, as reported in [64].



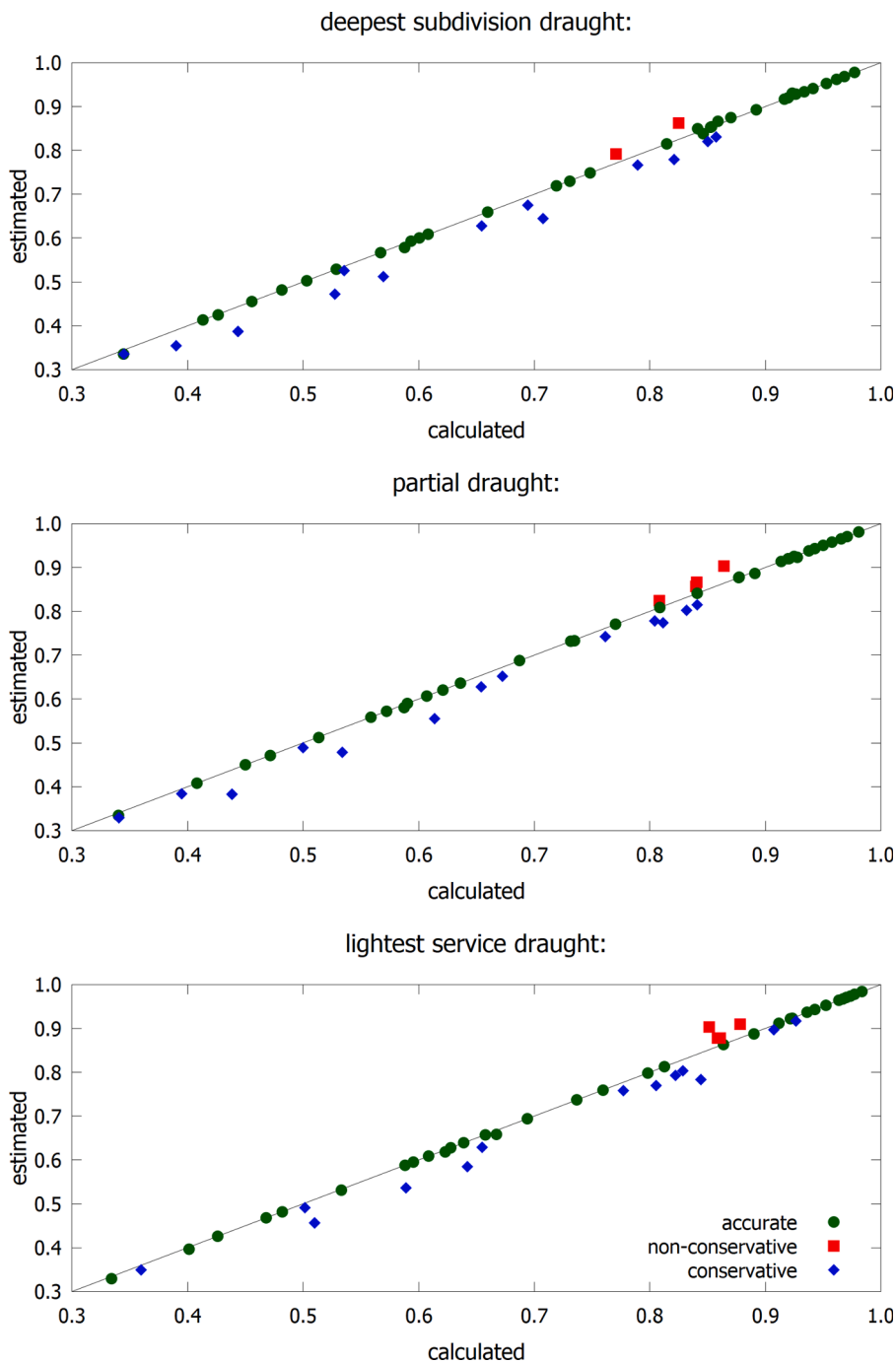

Fig. 11. Comparison of estimated and calculated relative A-index values at different loading conditions for a cruise ship with 50 combinations of open WTDs in non-adjacent transverse WT bulkheads.

A flowchart presenting the process of accident susceptibility index assignment is shown in Fig. 4.

### 3.2. Vulnerability to flooding

#### 3.2.1. Probabilistic damage stability calculations

An open watertight door causes progressive flooding to the adjacent compartment. Previously, in the so-called floatability assessment - [43] - only open doors connected to the breached compartments were considered to cause progressive flooding. However, open doors in adjacent transverse watertight bulkheads will significantly increase the vulnerability, and past incidents have grimly demonstrated that rapid closure of open watertight doors may not always be possible, [38]. In the

case of the *Queen of the North* in 2005, one WTD became jammed with debris after the grounding, and could not be closed, [69].

The number of possible combinations for the WTD statuses (open/closed) is  $2^n$  or a ship with  $n$  doors. Considering a typical large passenger ship with 20 WTDs, this means 1 048 576 possible combinations for each loading condition. Obviously, all these cases cannot be precalculated, and an alternative method is needed to rapidly assess the effect of open WTDs on damage stability and survivability of the ship.

In the current probabilistic damage stability framework in SOLAS Ch. II-1 Reg. 7 the vulnerability to flooding can be presented as [46]:

$$VL = 1 - A \tag{6}$$

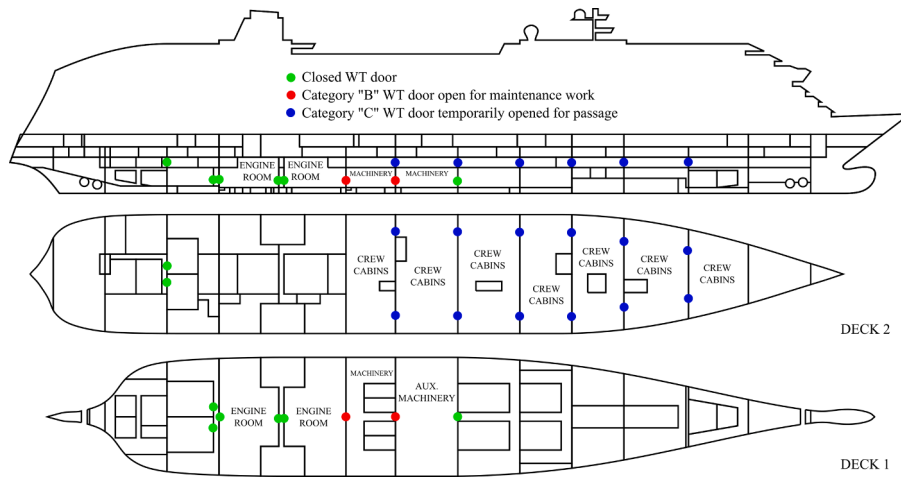

Fig. 12. Example cruise ship arrangement and WTD types and locations.

where  $A$  is the partial attained subdivision index for the studied loading condition, defined in [46] as:

$$A = \sum_{i=1}^N p_i s_i \quad (7)$$

where  $p_i$  is the probability of a damage extent  $i$  and  $s_i$  indicates the survivability level for that damage case. In total  $N$  damage cases are considered, the same set for each loading condition. Only collision damages are considered, using a zonal approach, where the probability  $p_i$  is evaluated based on the zone limits. In SOLAS the final attained subdivision index is obtained by weighting results for three characteristic loading conditions, but obviously in real time vulnerability assessment it is sufficient to consider only the real current condition.

The evaluation of the  $s$ -factor for index calculation requires assessment of various intermediate flooding stages and phases, as defined in [46]. For passenger ships with dense internal non-watertight subdivisions, this can include hundreds of alternative scenarios, [75]. Consequently, the computation time can be very long, up to several hours for one initial condition. More advanced survivability assessment, such as time-domain flooding simulation - [76] - would further increase the computation time. This means that for practical applications on-board a ship, less computationally demanding calculations, along the lines of the method presented in the following sections, are necessary.

### 3.2.2. Relative vulnerability level

The effects of open WTDs on the residual stability and buoyancy of the damaged ship can be taken into account by calculating an attained subdivision index, considering only the final stage of flooding and excluding the possible intermediate stages and phases, e.g. cross-flooding or A-class fireproof boundaries. The index is denoted with  $A^*$  - [54,77,78]. The normal statutory SOLAS zonal subdivision and damage cases, with probability represented by  $p$ -factor, are used. However, only two flooding stages are considered:

- the damaged WT compartments are flooded and
- progressive flooding to undamaged WT compartments through open WTDs.

In both cases, the flooded rooms are treated as lost buoyancy in the calculation of the righting lever curve, [75]. An example of the flooding stages in a two-compartment damage case with two open WTDs is shown in Fig. 5. The  $s$ -factor formula for the “final” stage, as per SOLAS Ch. II-1, paragraph 7-2.3, [46], sets stricter requirements for Ropax vessels, which are applied for all damage cases involving a ro-ro space (main vehicle deck or possible lower hold). The relevant openings, e.g. for

limiting the range of positive stability for  $s$ -factor calculation, should be the same as in SOLAS analyses.

The attained subdivision index, calculated for a condition with open WTDs,  $A_{open}^*$ , represents the decreased survivability level of the ship. However, this depends also on the actual loading condition. In order to quantify the decrease in survivability, i.e. the vulnerability, due to the open WTDs, the result needs to be normalized by the attained index with all WTDs closed,  $A_{closed}^*$ , at the same loading condition. Consequently, in [53,78] the relative index is defined as:

$$r^* = \frac{A_{open}^*}{A_{closed}^*} \quad (8)$$

In practice, this means that  $r^* = 1$  is the so-called target condition, where all WTDs are closed, or the open doors do not have a notable impact on the survivability. Consequently, the relative vulnerability to flooding is  $1 - r^*$ . A major advantage of this approach is that it can also be used for old ships that were designed according to the previous editions of SOLAS with deterministic damage stability requirements.

A comparison of the  $A^*$  index against the regulatory SOLAS attained subdivision index,  $A_{SOLAS}$ , with intermediate flooding stages included, is presented in Fig. 6 for five different passenger ship designs, Table 3. Damage stability calculations were done with NAPA software. All WTDs are assumed closed for calculation of both indices. The three characteristic loading conditions and the combined total index values are shown, indicating that the exclusion of intermediate flooding stages for  $A^*$ , results in slightly larger index values. However, this is considered accurate enough for practical flooding risk assessment on board.

### 3.2.3. Estimation of combined effect of several open watertight doors

The increased vulnerability due to open WTDs in adjacent transverse bulkheads may be much larger than the sum of effects due to single open WTDs. The combined effect of several open WTDs in non-adjacent transverse bulkheads can be estimated based on pre-calculated results for all conditions of open doors in adjacent transverse WT bulkheads. For any combination of open doors, the effective relative index can then be estimated as:

$$r_{eff}^* \approx 1 - \sum_{i=1}^n (1 - r_{open,i}^*) \quad (9)$$

In principle, this means that the effective reduction in  $r^*$  is the sum of the relative index reductions due to individual groups of adjacent open WTDs.

With this approach, the required number of door status combination cases for calculation of the attained index  $A^*$  for a ship with doors in  $n$  transverse WT bulkheads is:

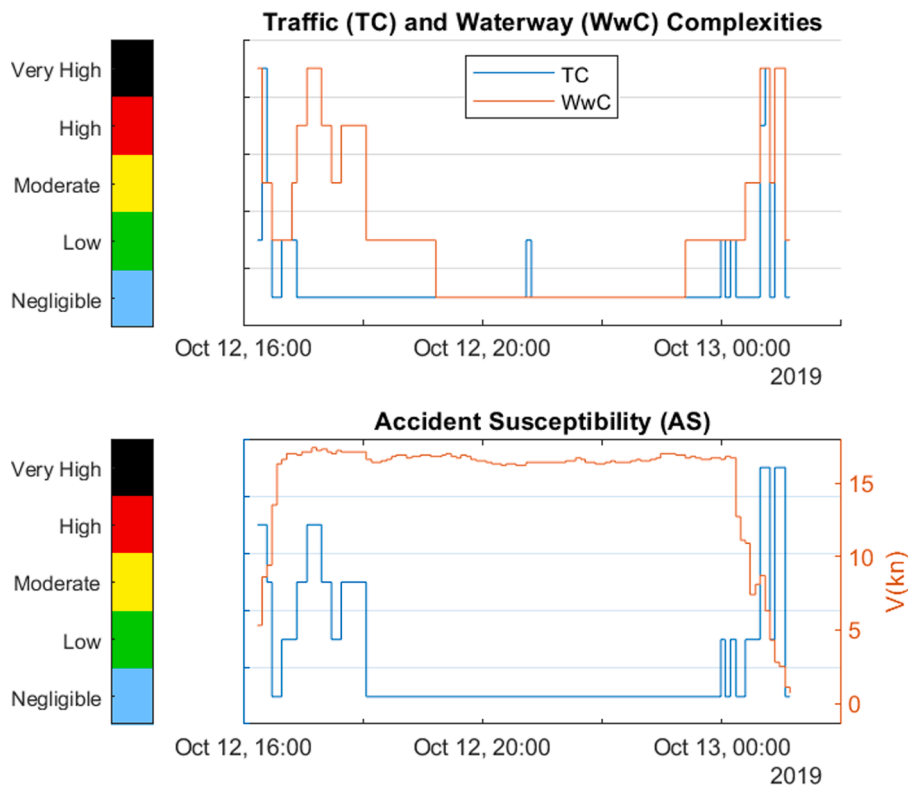
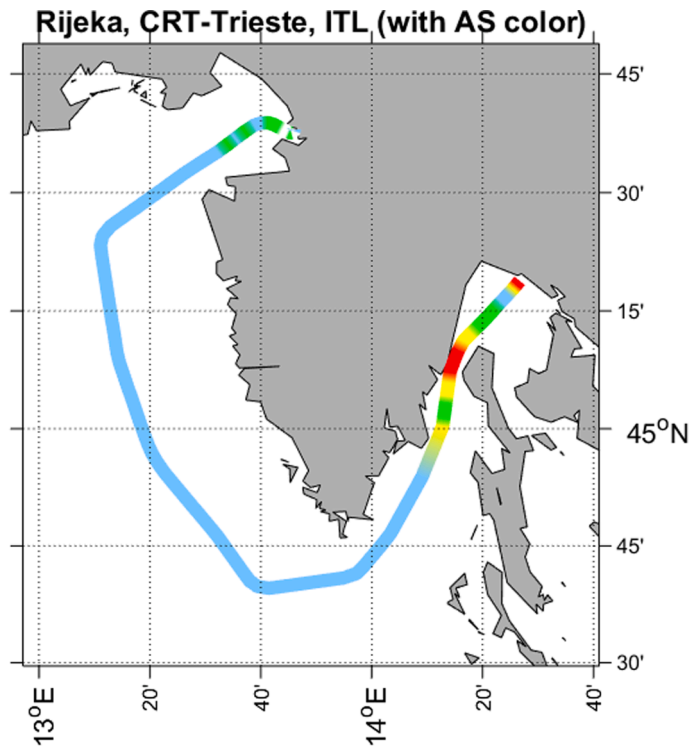

Fig. 13. Accident susceptibility and its components during a voyage from Rijeka to Trieste, [62].

$$N_{calc} = 1 + \sum_{i=1}^n i = 1 + \frac{n \cdot (n + 1)}{2} \quad (10)$$

$$N_{comb} = 2^n \quad (11)$$

Which is significantly smaller than the number of all door status combinations:

Therefore, this approach makes it possible to use a database with pre-calculated results that are prepared for the whole operational range of draft, trim and metacentric height (GM) values, with reasonable steps. Linear interpolation could also be used in between the calculated

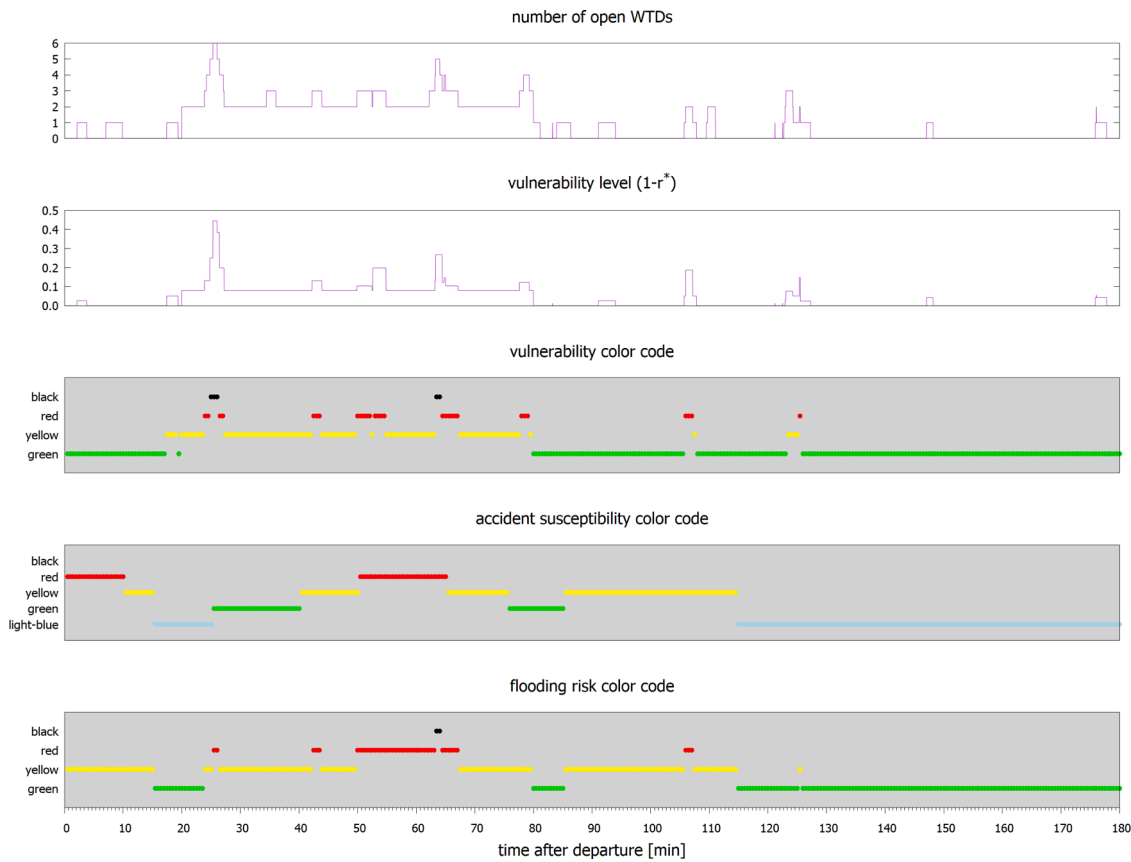

Fig. 14. Example of development of vulnerability after departure from Rijeka with maintenance work requiring two category “B” WTDs to be open for 60 min.

loading conditions.

### 3.2.4. The influence of sea states

The prevailing sea state can have a notable effect on the survivability of the ship [79]. In (nearly) calm seas the relative attained subdivision index  $r^*$  is considered as a reasonably good measure of the safety level for the purpose of vulnerability monitoring. However, in a harsh sea state, compromised subdivision due to an open WTD may be more serious. In any case, the target level, i.e. zero vulnerability, should be reached in a condition where all WTDs are closed, and therefore,  $r^* = 1$ .

A simplified approach to account for increased vulnerability due to high waves is suggested. The operational vulnerability level due to open WTDs can be presented as:

$$VL = 1 - f(r^*, H_{s,ref}) \tag{12}$$

Where the function  $f(r^*, H_{s,ref})$  represents survivability, and  $H_{s,ref}$  is a reference significant wave height, evaluated based on the actual prevailing significant wave height  $H_s$ . In nearly calm weather the  $r^*$  index directly represents the vulnerability, so that  $VL = 1 - r^*$ . In higher waves, the vulnerability to flooding is assumed to increase linearly, and for this purpose, the following three parameters are defined:

- $H_{s,min}$  limit significant wave height for nearly calm sea
- $H_{s,max}$  limit significant wave height for harsh weather
- $r^*_{zero}$  limit  $r^*$  value that results in maximum vulnerability in harsh weather

If  $H_s \leq H_{s,min}$ , then  $r^*$  is used directly. In a harsh sea state, when  $H_s \geq H_{s,max}$ , survivability is nullified if  $r^* < r^*_{zero}$  and it increases linearly to unity when  $r^* = 1$ . For the sea states with wave height between the limits for calm and harsh sea state, linear interpolation is applied. The approach is visualized in Fig. 7.

In practice, this means that the reference sea state is defined as:

$$H_{s,ref} = \min(H_{s,max}, \max(H_{s,min}, H_s)) \tag{13}$$

and the factor for damage survivability in Eq. (12) is:

$$f(r^*, H_{s,ref}) = \max\left(1 + \frac{1 - r^*}{r_0(H_{s,ref}) - 1}, 0\right) \tag{14}$$

where the largest  $r^*$  value, resulting in  $f = 0$  in the given sea state with wave height  $H_{s,ref}$ , is:

$$r_0(H_{s,ref}) = \frac{r^*_{zero} \cdot (H_{s,ref} - H_{s,min})}{H_{s,max} - H_{s,min}} \tag{15}$$

Finally, suitable numeric values for the three parameters need to be selected. Based on the assumption of  $H_s$  for the s-factor calculation, see for example [80], it seems reasonable to define  $H_{s,max} = 4.0$  m. This is also supported by the analysis of operational data in the EU Horizon2020 project FLARE reported in [64,81], indicating that passenger ships normally operate in a sea state with significant wave height of 3.0 m or less.

It might also be justified to apply ship specific parameters, especially for  $H_{s,min}$ . For large and medium sized passenger ships  $H_{s,min} = 2.0$  m is considered suitable. Furthermore,  $r^*_{zero} = 0.6$  is initially recommended, based on damage stability calculations with the sample ships presented in Table 3. However, it is noted that more comprehensive studies should still be conducted, and the parameters in Eq. (14) can be fine-tuned based on new evidence. The present approach is illustrated in Figure 7.

### 3.2.5. Color coding for vulnerability

In practice, the vulnerability to flooding is never negligible when the ship is sailing at sea. Even with all WTDs closed, an extensive breach in the hull could result in sinking or capsizing. Considering this, a

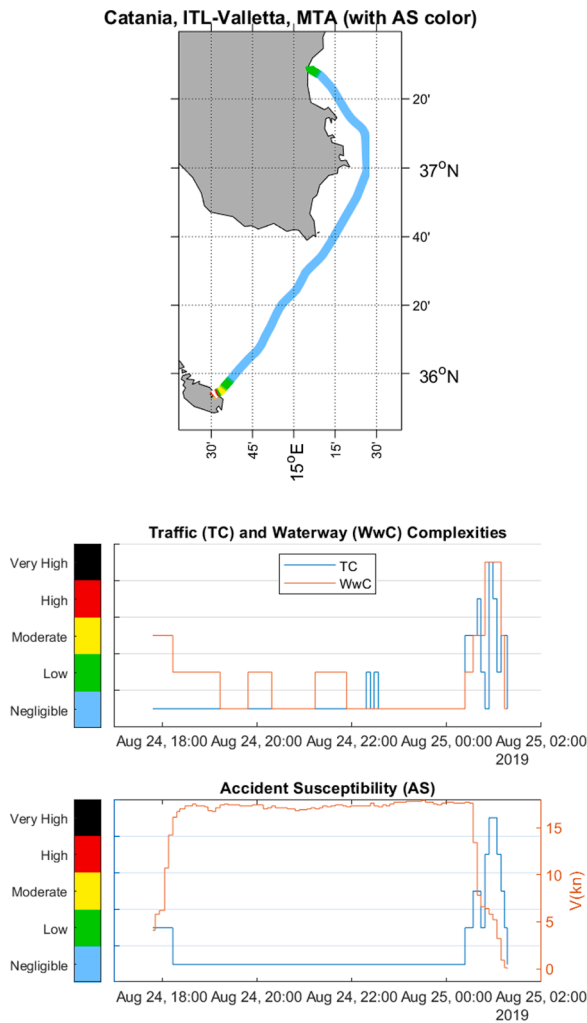

Fig. 15. Accident susceptibility level and its components on a voyage from Catania to Valletta.

suggestion for the threshold levels for different color codes are presented in Fig. 8. These are also used in the case studies in Section 5. In principle, ship- and operator-specific threshold values could be used, especially in case of retrofit installations to old ships.

#### 4. Application of risk framework on case studies

##### 4.1. Demonstration methodology

An unbuilt 63 000 GT cruise ship design FLOODSTAND B, [82] Fig. 9, is used as an example. The main parameters of the ship are listed in Table 4. A realistic operational loading condition with a draft of 7.2 m and an intact metacentric height of 2.62 m is assumed.

The developed system is intended for onboard application, using surrounding traffic and bathymetric conditions, actual loading condition and WTD status as input for evaluation of both accident susceptibility and vulnerability. The former is taken for one year of operation of large cruise ship (100 000 GT), involved in world-wide shipping. The processing of the data and the evaluation of the accident susceptibility level has been described in detail in [62].

Historical data on WTD status was not available for the analyzed ship, hence artificial door status signals were needed for testing and demonstration purposes. Previously, in [23], generated door status signals have been used based on assumed probability distributions for each WTD category. For category “C” doors this approach is reasonable,

if the doors are opened only to allow a person to pass through. However, in general the opening status of a WTD is not a random process but depends on the work in the vicinity of the door and the onboard operational culture. For initial testing, two realistic scenarios were generated, which are presented in the following sections.

It should be noted that the studied cruise ship design is from 2009, and that there are therefore several WTDs connecting to the crew cabin areas on deck 2. This is suitable for demonstrating the effects of open WTDs on vulnerability to flooding, but on modern passenger ships the number of doors would be much smaller.

##### 4.2. Precalculated damage stability results

The relative subdivision index values,  $r^*$ , were calculated with NAPA software for the studied loading condition. The results are shown in Fig. 10 for different combinations of open WTDs in adjacent transverse WT bulkheads. The vulnerability assessment is based on these pre-calculated results. For visualization, the results for each number of open WTDs are connected by straight lines. The x-coordinate in the graph marks the average x-location of the open WTDs. The locations of the open doors have a notable impact on vulnerability, and e.g. in the aft part of the ship a single open WTD has a smaller increase of vulnerability than in the forward part of the ship.

For example, a case with open WTDs in the transverse bulkheads C, I, J and L (see Fig. 9) can be estimated by using Eq. (9) as:

$$r_{CIL}^* \approx 1 - (1 - r_C^*) - (1 - r_I^*) - (1 - r_L^*) \quad (16)$$

where  $r_C^*$  and  $r_L^*$  are relative index values for cases with a single open WT door in bulkheads C and L, respectively, and  $r_{IJ}^*$  is the relative index for the case where there are open WTDs in the two adjacent transverse bulkheads I and J. This results in:

$$r_{CIL}^* \approx 1 - (1 - 0.96316) - (1 - 0.81290) - (1 - 0.95652) = 0.73258 \quad (17)$$

Direct calculation of the same case results in  $r^* = 0.73494$ , and the difference is only about 0.3%.

The probabilistic damage stability analysis in SOLAS includes a large number of damage cases depending on the subdivision and geometry of the ship [46]. The group of all damage cases in the index calculation is denoted with  $D_{all}$ , and the subgroups of damages that involve progressive flooding through a single open WTD A and B are denoted with  $D_A$  and  $D_B$ , respectively. The above approximation assumes that the intersection  $D_A \cap D_B$  is small, i.e. the union  $D_A \cup D_B \approx D_A + D_B$ . This is valid for open WTDs that are far away from each other since the absolute maximum damage length in SOLAS Ch. II-1 is 60 m, [46].

A comparison of estimation with Eq. (9) and directly calculated  $r^*$  values for 50 different random combinations of several open WTDs is presented in Fig. 11, using the three SOLAS initial conditions. The cases involve open WTDs in 2-9 transverse WT bulkheads. In most cases the estimate matches perfectly the directly calculated value. In the cases, where there are several “blocks” with more than one open WTD, the summation approach tends to underestimate the relative index since the same damage cases with reduced s-factor are included more than once. Consequently, the adopted approach is somewhat conservative, but reasonably accurate for the purpose of vulnerability monitoring onboard a ship. In some cases, with only a small number of open WTDs close to each other, the estimate is non-conservative (red squares in Fig. 11).

##### 4.3. Case A - maintenance work after departure from Rijeka

Real AIS data for a voyage from Rijeka, Croatia to Trieste, Italy is applied. After departure the ship sails in the Kvarner Gulf with high accident susceptibility, governed mainly by the waterway complexity, due to shallow waters on both sides of the fairway. At the same time, since the sea area is sheltered, the significant wave height is assumed to



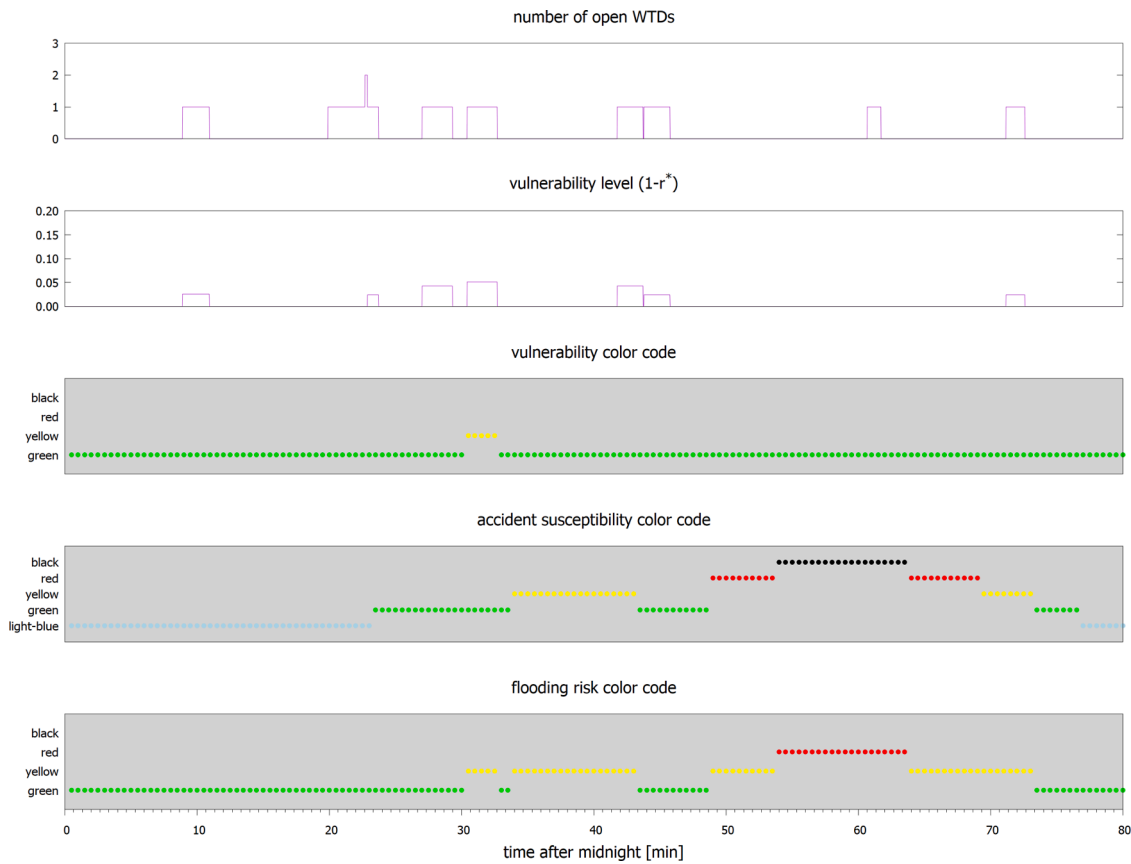

Fig. 16. Example of development of vulnerability arrival at Valletta with randomly opened category “C” WTDs in the crew cabin areas.

be small.

Maintenance work requires two “B” class WTDs on deck 1 to be open for a longer period. The work is started 20 min after departure and continues for 60 min. The “C” class WTDs on the crew cabin areas on deck 2 are assumed to be opened randomly with an average frequency of once in an hour. The opening time was randomly selected between 60 s and 180 s. Types and locations of the doors are shown in Fig. 12. The results are presented in Figs. 13 and 14 for 3 hours after the departure.

Soon after the maintenance work has started, there is a short time period when a total of 6 WTDs are simultaneously open, resulting in a very high vulnerability level. At this time, the accident susceptibility is low (green), and consequently the risk level is high (red). Later, about 63 min after departure, total of 5 WTDs are open, resulting in very high vulnerability to flooding. At the same time, accident susceptibility is high due to the narrow fairway, and this combination results in very high (black) operational risk for a short period of time. During the maintenance work the risk level remains high or very high (red or black) for nearly 20 min. Such work should be planned so that it is not done when the ship is sailing in areas where high accident susceptibility levels are expected.

#### 4.4. Case B: operation in high accident susceptibility area

The second example focuses on an operational condition with high accident susceptibility. The ship is sailing from Catania, Italy to Valletta, Malta. After midnight, when the ship is approaching Valletta, both the traffic and waterway complexity increase, resulting in the very high accident susceptibility shown in Fig. 15.

All WTDs are primarily closed, but the category “C” doors in the crew cabin areas on deck 2 are randomly opened. The opening time was randomly selected between 60 s and 180 s. The resulting vulnerability levels and accident susceptibility from real historical AIS data are shown

in Fig. 16. The maximum number of simultaneously open WTDs is two, and the vulnerability to flooding remains low (green) or moderate (yellow). However, when approaching to Valletta the accident susceptibility is high (red) or very high (black) for a long period, and consequently the flooding risk is also high (red). Any work requiring category “B” WTDs to be open would cause a very high risk level. Based on this example, proper usage of category “C” WTDs when passing through them does not significantly increase the risk, even when the ship is operating in areas with high accident susceptibility.

## 5. Discussion

The presented framework is considered suitable for continuous assessment and monitoring of flooding risk onboard passenger ships. The required input data (actual loading condition, WTD status, AIS data for nearby ships, bathymetry and weather now-cast) is already available through various systems, but not yet integrated into a single system for risk monitoring. In a case where flooding is detected, the flooding risk assessment tool should automatically switch into a decision support system (DSS) [83]. The adopted risk metric, combining susceptibility and vulnerability into a qualitative measure, is considered suitable for screening purposes and for discrimination among the given operational situations. Therefore, the proposed solution for flooding risk assessment should be seen as an operational guidance tool for the crew, allowing proactive risk mitigation actions, either through reduction of susceptibility, vulnerability, or both.

The concept of accident susceptibility, as detailed in [62], is based on an assessment of traffic, waterway, and environmental complexity. The threshold values for evaluating the levels of these parameters are based on both the literature and the perceptions of crew members as given by the results of a questionnaire. Some fine-tuning of the criteria for different complexity levels may still be needed, based on more extensive

testing. For the case studies presented here, conditions of good visibility are assumed. This is mainly due to a lack of reliable temporospatial data on visibility. However, if this framework is to be employed on board ships, actual visibility conditions can be used for instant and continuous evaluation of accident susceptibility. In addition, the effect of sea state on the vulnerability to flooding due to open WTDs should be investigated further, while the effect of ship size should also be considered.

The presented test cases are based on a big data analysis of historical AIS data and generated WTD status combinations. Real operational data on WTD status and accident susceptibility based on AIS receivers on-board should be analyzed in detail when a prototype version of the developed method is installed on ships. By being based on such real data, the risk assessment method can be further improved, especially by fine-tuning the threshold values used for the color codes. The presented test cases indicate that the continuous monitoring of flooding risk can enable an improved onboard safety culture through better awareness of the flooding risk when WTDs are kept open for longer timeframes.

Recently, King et al. in [40] concluded that “the traditionally design focused culture for stability management must be shifted to one where the operation is seen as integral player to maintaining barrier integrity”. The presented framework for onboard assessment and monitoring of flooding risk due to watertight doors is considered a valuable tool for increasing the situational awareness among the bridge crew, which in turn may contribute to the elevation of safety culture in the daily operation of the ship. Most notably, such a system can easily be installed on board the existing fleet as most of the required input data is readily available from the automation systems. However, more studies are still needed to make the proposed solution operational, to ensure that the applied color coding is reasonable for actual passenger ship operations, and to encourage safer onboard practices.

The monitoring system could also trigger an alarm on the bridge. However, the applied threshold values for both the risk level and the allowed time frame need to be carefully considered since overly frequent alarms, or fluctuating alarms, are known to be annoying to crew, e.g. [84], and therefore may not lead to an increase in safety through improved operational practices. Therefore, operational tests must be made, and modifications to the alarm thresholds must be agreed upon with the prospective end-users, to reflect actual safe operational routines as much as possible.

In addition, other modeling approaches which transform the proposed deterministic framework into a probabilistic one may be tested in the future. The intention of this transformation is to better capture the uncertainty associated with the input parameters, and to better reflect their effect on the outcome, which would help decrease risk index fluctuation. Bayesian Networks may be found particularly useful to such an approach.

The present framework is limited both by the zonal approach of the SOLAS regulations, and by the consideration only of collision damages. However, the same framework can be extended to also consider bottom and side grounding damages, for example with the non-zonal approach described in [85,86]. However, in the case of the non-zonal method, the same damage cases, with precalculated probabilities (i.e. p-factors) should be applied for different WTD status combinations. Increased computing capacity implies that, in the future, intermediate flooding stages could also be included in the index calculation.

The presented concept considers only damage stability, longitudinal strength considerations may also be critical, especially in cases with extensive flooding. In the future, the developed framework could be extended to include strength as a parameter affecting survivability, i.e. the s-factor, in the  $A^*$  index calculation. However, a necessary condition for such an extension is the development of rapid and reliable methods for evaluating the residual strength of damaged passenger ships.

## 6. Conclusions

Open watertight doors on passenger ships during operation impose a

serious risk because they compromise the ship's designed watertight integrity. However, in certain conditions, open WTDs are allowed for new ships. Therefore, continuous monitoring of the operational vulnerability due to open WTDs is an effective way to increase the crew awareness and safety.

The aim of this paper was to introduce a framework primarily intended for the rapid assessment and real-time monitoring of operational flooding risk of a passenger ship, accounting for relevant, observable risk-affecting factors and mechanisms driving the process of both the accident and its aftermath. Eventually, such a framework will allow risk-informed mitigation measures to be undertaken in due time.

The proposed framework is based on the actual operational conditions, and can rapidly evaluate the vulnerability to flooding for any combination of open WTDs. Furthermore, by using an accident susceptibility index estimated from traffic and waterway complexities affecting the performance of the on-board ship navigator, the real-time flooding risk can be rapidly evaluated.

Further research is still needed, especially regarding the effect of sea state and visibility on the susceptibility and vulnerability indices and the applied criteria for determining the color coding for both indices. The examples presented show that high flooding risk can easily be encountered in sea areas with high accident susceptibility, especially if maintenance work requires some class “B” WTDs to be open for an extended period. Continuous monitoring of the risk level is expected to help in improving operational practices, and in the long term, provide useful information for designing safer general arrangements with less need for WTDs. In principle, the presented method is considered mature enough for a prototype implementation to be tested on board real ships and from which valuable real-world operational data and feedback can be gathered.

## CRedit authorship contribution statement

**Pekka Ruponen:** Conceptualization, Methodology, Investigation, Writing – original draft, Visualization, Writing – review & editing. **Jakub Montewka:** Conceptualization, Methodology, Investigation, Writing – original draft, Writing – review & editing. **Markus Tompuri:** Project administration, Investigation, Writing – review & editing. **Teemu Manderbacka:** Investigation, Formal analysis, Writing – review & editing. **Spyros Hirdaris:** Project administration, Writing – review & editing.

## Declaration of Competing Interest

The authors declare that they have no known competing financial interests or personal relationships that could have appeared to influence the work reported in this paper.

## Data Availability

The authors do not have permission to share data.

## Acknowledgments

The research presented in this paper was carried out within the framework of the project Flooding Accident Response (FLARE), no. 814753, funded by the European Union under the Horizon 2020 program, which is gratefully acknowledged. The views set out in this paper are solely those of the authors and do not necessarily reflect the views of their respective organizations. Meyer Werft is thanked for providing the cruise ship design for testing and demonstration.

## References

- [1] Papanikolaou A. *Risk-Based Ship Design: Methods, Tools and Applications*. Springer; 2009.
- [2] Kujala P, Ehlers S. A risk-based evaluation ice-strengthened hull structures. ICETECH 2014.
- [3] Kujala P, Goerlandt F, Way B, Smith D, Yang M, Khan F, et al. Review of risk-based design for ice-class ships. *Mar Struct* 2019;63:181–95. <https://doi.org/10.1016/j.marstruc.2018.09.008>.
- [4] Bergström M, Erikstad SO, Ehlers S. Assessment of the applicability of goal- and risk-based design on Arctic sea transport systems. *Ocean Eng* 2016;128:183–98. <https://doi.org/10.1016/j.oceaneng.2016.10.040>.
- [5] Montewka J, Goerlandt F, Innes-Jones G, Owen D, Hifi Y, Puisa R. Enhancing human performance in ship operations by modifying global design factors at the design stage. *Reliab Eng Syst Saf* 2017;159:283–300. <https://doi.org/10.1016/j.res.2016.11.009>.
- [6] Spyrou KJ, Koromila IA. A risk model of passenger ship fire safety and its application. *Reliab Eng Syst Saf* 2020;200:106937. <https://doi.org/10.1016/J.RESS.2020.106937>.
- [7] Du L, Banda OAV, Huang Y, Goerlandt F, Kujala P, Zhang W. An empirical ship domain based on evasive maneuver and perceived collision risk. *Reliab Eng Syst Saf* 2021;107752. <https://doi.org/10.1016/j.res.2021.107752>.
- [8] Du L, Goerlandt F, Kujala P. Review and analysis of methods for assessing maritime waterway risk based on non-accident critical events detected from AIS data. *Reliab Eng Syst Saf* 2020;200:106933. <https://doi.org/10.1016/j.res.2020.106933>.
- [9] Szlapczynski R, Szlapczynska J. A ship domain-based model of collision risk for near-miss detection and Collision Alert Systems. *Reliab Eng Syst Saf* 2021;214:107766. <https://doi.org/10.1016/j.res.2021.107766>.
- [10] Gil M. A concept of critical safety area applicable for an obstacle-avoidance process for manned and autonomous ships. *Reliab Eng Syst Saf* 2021;214:107806. <https://doi.org/10.1016/j.res.2021.107806>.
- [11] Gil M, Montewka J, Krata P, Hinz T, Hirdaris S. Determination of the dynamic critical maneuvering area in an encounter between two vessels: Operation with negligible environmental disruption. *Ocean Eng* 2020;213:107709. <https://doi.org/10.1016/j.oceaneng.2020.107709>.
- [12] Altan YC, Otay EN. Spatial mapping of encounter probability in congested waterways using AIS. *Ocean Eng* 2018;164:263–71. <https://doi.org/10.1016/j.oceaneng.2018.06.049>.
- [13] United States Coast Guard. Ports and waterways safety assessment (PAWSA) 2005.
- [14] Friis-Hensen P. *Basic principles for prediction of collision and grounding frequencies*. IWRAP MK II Working document. Denmark: Copenhagen; 2008.
- [15] Mazurek J, Lu L, Krata P, Montewka J, Krata H, Kujala P. An updated method identifying collision-prone locations for ships. A case study for oil tankers navigating in the Gulf of Finland. *Reliab Eng Syst Saf* 2022. Paper accepted.
- [16] Zhang M, Zhang D, Fu S, Kujala P, Hirdaris S. A predictive analytics method for maritime traffic flow complexity estimation in inland waterways. *Reliab Eng Syst Saf* 2022;220:108317. <https://doi.org/10.1016/J.RESS.2021.108317>.
- [17] Leveson NG. *Engineering a Safer World - Systems Thinking Applied to Safety*. Cambridge, MA: MIT Press; 2011.
- [18] Giustiniano L, Cunha MP e, Clegg S. The dark side of organizational improvisation: Lessons from the sinking of Costa Concordia. *Bus Horiz* 2016;59:223–32. <https://doi.org/10.1016/J.BUSHOR.2015.11.007>.
- [19] Kaplan S. The Words of Risk Analysis. *Risk Anal* 1997;17:407–17. <https://doi.org/10.1111/j.1539-6924.1997.tb00881.x>.
- [20] Aven T. The risk concept—historical and recent development trends. *Reliab Eng Syst Saf* 2012;99:33–44. <https://doi.org/10.1016/j.res.2011.11.006>.
- [21] Goerlandt F, Montewka J. Maritime transportation risk analysis: Review and analysis in light of some foundational issues. *Reliab Eng Syst Saf* 2015;138:115–34. <https://doi.org/10.1016/j.res.2015.01.025>.
- [22] Puisa R, McNay J, Montewka J. Maritime safety: Prevention versus mitigation? *Saf Sci* 2021;136. <https://doi.org/10.1016/j.ssci.2020.105151>.
- [23] Bertheussen Karoliuss K, Ad. Psarros G, Astrup OC, Liang Q, van Welter C, Vassalos D. Maritime operational risk management using dynamic barriers. *Ships Offshore Struct* 2021;1–15. <https://doi.org/10.1080/17445302.2021.1894028>.
- [24] Vanem E, Puisa R, Skjong R. Standardized Risk Models for Formal Safety Assessment of Maritime Transportation. In: Proceedings of the ASME 28th International Conference on Ocean, Offshore and Arctic Engineering OMAE, ASME; 2009. p. 51–61. <https://doi.org/10.1115/OMAE2009-79062>.
- [25] IMO. Formal safety assessment - Consolidated text of the guidelines for formal safety assessment (FSA) for use in the IMO rule-making process (MSC/Circ.1023-MEPC/Circ.392) 2007.
- [26] IMO. Revised guidelines for formal safety assessment (FSA) for use in the IMO rule-making process. MSC-MEPC.2/Circ.12. London; 2013.
- [27] Montewka J, Goerlandt F, Kujala P. On a systematic perspective on risk for formal safety assessment (FSA). *Reliab Eng Syst Saf* 2014;127:77–85. <https://doi.org/10.1016/j.res.2014.03.009>.
- [28] Kontovas CA, Psaraftis HN. Formal Safety Assessment: A Critical Review. *Mar Technol* 2009;46:45–59.
- [29] Psaraftis HN. Formal Safety Assessment: an updated review. *J Mar Sci Technol* 2012;17:390–402. <https://doi.org/10.1007/s00773-012-0175-0>.
- [30] Devanney J. Formal Safety Assessment in Wonderland 2013.
- [31] Logan TM, Aven T, Guikema SD, Flage R. Risk science offers an integrated approach to resilience. *Nature Sustain* 2022;2022:1–8. <https://doi.org/10.1038/s41893-022-00893-w>.
- [32] Aven T. A risk science perspective on the discussion concerning Safety I, Safety II and Safety III. *Reliab Eng Syst Saf* 2022;217:108077. <https://doi.org/10.1016/J.RESS.2021.108077>.
- [33] Askeland T, Flage R, Aven T. Moving beyond probabilities – Strength of knowledge characterisations applied to security. *Reliab Eng Syst Saf* 2017;159:196–205. <https://doi.org/10.1016/J.RESS.2016.10.035>.
- [34] Aven T. The reliability science: Its foundation and link to risk science and other sciences. *Reliab Eng Syst Saf* 2021;215:107863. <https://doi.org/10.1016/J.RESS.2021.107863>.
- [35] Aven T. A conceptual framework for linking risk and the elements of the data-information-knowledge-wisdom (DIKW) hierarchy. *Reliab Eng Syst Saf* 2013;111:30–6. <https://doi.org/10.1016/j.res.2012.09.014>.
- [36] Goerlandt F, Montewka J. Maritime transportation risk analysis: Review and analysis in light of some foundational issues. *Reliab Eng Syst Saf* 2015;138:115–34. <https://doi.org/10.1016/j.res.2015.01.025>.
- [37] Sepehri A, Vandchali HR, Siddiqui AW, Montewka J. The impact of shipping 4.0 on controlling shipping accidents: A systematic literature review. *Ocean Eng* 2021;110162. <https://doi.org/10.1016/J.OCEANENG.2021.110162>.
- [38] Rosvall G, Rosengren H, Lindemalm P, Bergön L. Report RS 2005:03e Collision between dry-cargo vessel Joanna and ro-ro passenger ferry Stena Nautica off Varberg. N county 2005.
- [39] Injuries and deaths caused by watertight doors - GARD. Gard News 207 2012.
- [40] King T, van Welter C, Svensen TE. Stability barrier management for large passenger ships. *Ocean Eng* 2016;125:342–8. <https://doi.org/10.1016/J.OCEANENG.2016.06.049>.
- [41] The Editorial Team. DNV GL, Gard initiate watertight doors awareness campaign - SAFETY4SEA 2017.
- [42] Jan Rodseth Ø. Passenger ship safety and emergency management control. In: Lloyds register and Fairplay conference Cruise and Ferry; 2005.
- [43] IMO. MSC.1/Circular.1564 – Revised Guidance for Watertight Doors on Passenger Ships Which may be Opened During Navigation. London; 16 July 2017. p. 2011. –.
- [44] IMO. Guidance for watertight doors on passenger ships, MSC.1/Circ. 1380. London; 2011.
- [45] Person J. Impact of Watertight Door Regulations on Ship Survivability. *Fluid Mech Appl* 2019;119:773–7. [https://doi.org/10.1007/978-3-030-00516-0\\_45](https://doi.org/10.1007/978-3-030-00516-0_45).
- [46] International Maritime Organization. SOLAS consolidated edition. London; 2020.
- [47] Jasonowski A. Decision support for ship flooding crisis management. *Ocean Eng* 2011;38:1568–81. <https://doi.org/10.1016/j.oceaneng.2011.06.002>.
- [48] Pennanen P, Ruponen P, Ramm-Schmidt H. Integrated decision support system for increased passenger ship safety. Damaged ship III, London: RINA. Royal Institution of Naval Architects; 2015.
- [49] Trincas G, Braidotti L, de Francesco L. Risk-based system to control safety level of flooded passenger ships. Brodogradnja : Teorija i Praksa Brodogradnje i Pomorske Tehnike 2017;68:31–60. <https://doi.org/10.21278/BROD68103>.
- [50] Boulougouris E, Cichowicz J, Jasonowski A, Konovessis D. Improvement of ship stability in damaged condition through operational measures: Challenges and opportunities. *Ocean Eng* 2016;122:311–6. <https://doi.org/10.1016/J.OCEANENG.2016.06.010>.
- [51] Manderbacka T, Themelis N, Bačkalo V, Boulougouris E, Eliopoulou E, Hashimoto H, et al. An overview of the current research on stability of ships and ocean vehicles: The STAB2018 perspective. *Ocean Eng* 2019;186:106090. <https://doi.org/10.1016/J.OCEANENG.2019.05.072>.
- [52] Jasonowski A. Decision Support for Crisis Management and Emergency... - Google Scholar. In: Proceedings of the 11th International Ship Stability Workshop; 2010. p. 209–16.
- [53] Jasonowski A, Luhmann H, Bertin R, Routi A-L, Cardinale M, Harper G. Evaluation of risk from watertight doors, EMSA/OP/10/2013. 2015.
- [54] Cruise Ship Safety Forum. Damage stability and survivability. Monitoring and assessing risk from operation of watertight doors. Recommendation 2016. 312/2016.
- [55] Gil M, Koziol P, Wróbel K, Montewka J. Know your safety indicator – A determination of merchant vessels Bow Crossing Range based on big data analytics. *Reliab Eng Syst Saf* 2022;220:108311. <https://doi.org/10.1016/J.RESS.2021.108311>.
- [56] Wróbel K. Searching for the origins of the myth: 80% human error impact on maritime safety. *Reliab Eng Syst Saf* 2021;216:107942. <https://doi.org/10.1016/J.RESS.2021.107942>.
- [57] Wang H, Liu Z, Wang X, Graham T, Wang J. An analysis of factors affecting the severity of marine accidents. *Reliab Eng Syst Saf* 2021;210:107513. <https://doi.org/10.1016/J.RESS.2021.107513>.
- [58] Fan S, Blanco-Davis E, Yang Z, Zhang J, Yan X. Incorporation of human factors into maritime accident analysis using a data-driven Bayesian network. *Reliab Eng Syst Saf* 2020;203:107070. <https://doi.org/10.1016/J.RESS.2020.107070>.
- [59] Fu S, Goerlandt F, Xi Y. Arctic shipping risk management: a bibliometric analysis and a systematic review of risk influencing factors of navigational accidents. *Saf Sci* 2021;139. <https://doi.org/10.1016/j.ssci.2021.105254>.
- [60] Puisa R, Lin L, Bolbot V, Vassalos D. Unravelling causal factors of maritime incidents and accidents. *Saf Sci* 2018;110:124–41. <https://doi.org/10.1016/j.ssci.2018.08.001>.
- [61] Zhang M, Conti F, le Sourne H, Vassalos D, Kujala P, Lindroth D, et al. A method for the direct assessment of ship collision damage and flooding risk in real conditions. *Ocean Eng* 2021;237:109605. <https://doi.org/10.1016/j.oceaneng.2021.109605>.
- [62] Montewka J, Manderbacka T, Ruponen P, Tompuri M, Gil M, Hirdaris S. Accident susceptibility index for a passenger ship-a framework and case study. *Reliab Eng Syst Saf* 2022;218:108145. <https://doi.org/10.1016/J.RESS.2021.108145>.

- [63] Zhang M, Montewka J, Manderbacka T, Kujala P, Hirdaris S. A Big data analytics method for the evaluation of ship - ship collision risk reflecting hydrometeorological conditions. *Reliab Eng Syst Saf* 2021;213:107674. <https://doi.org/10.1016/j.ress.2021.107674>.
- [64] Zhang M, Montewka J, Manderbacka T, Kujala P, Hirdaris S. Analysis of the Grounding Avoidance Behavior of a Ro-Pax Ship in the Gulf of Finland using Big Data. *ISOPE-I-20-4226* 2020.
- [65] Reese RM, Calvano CN, Hopkins TM. Operationally Oriented Vulnerability Requirements in the Ship Design Process. *Nav Eng J* 1998;110:19–34. <https://doi.org/10.1111/j.1559-3584.1998.tb02383.x>.
- [66] Boulougouris E, Papanikolaou A. Risk-based design of naval combatants. *Ocean Eng* 2013;65:49–61. <https://doi.org/10.1016/j.oceaneng.2013.02.014>.
- [67] Kim SJ, Köggersaar M, Ahmadi N, Taimuri G, Kujala P, Hirdaris S. The influence of fluid structure interaction modelling on the dynamic response of ships subject to collision and grounding. *Mar struct* 2021;75:102875. <https://doi.org/10.1016/J.MARSTRUC.2020.102875>.
- [68] Kim SJ, Taimuri G, Kujala P, Conti F, le Sourne H, Pineau JP, et al. Comparison of numerical approaches for structural response analysis of passenger ships in collisions and groundings. *Mar struct* 2022;81:103125. <https://doi.org/10.1016/J.MARSTRUC.2021.103125>.
- [69] BC Ferries. Queen of the North Grounding and Sinking on March 22nd 2006, Divisional Inquiry #815-06-01. 2007.
- [70] Taimuri G, Kim SJ, Mikkola T, Hirdaris S. A two-way coupled FSI model for the rapid evaluation of accidental loads following ship hard grounding. *J Fluids Struct* 2022;112:103589. <https://doi.org/10.1016/J.JFLUIDSTRUCTS.2022.103589>.
- [71] Susceptibility Definition & Meaning - Merriam-Webster n.d. <https://www.merriam-webster.com/dictionary/susceptibility> (accessed March 2, 2022).
- [72] Corporate Risk Associates. A user manual for the nuclear action reliability assessment (NARA) human error quantification technique. UK: Surrey; 2011. Report No 2.
- [73] Wu B, Yip TL, Yan X, Guedes Soares C. Review of techniques and challenges of human and organizational factors analysis in maritime transportation. *Reliab Eng Syst Saf* 2022;219:108249. <https://doi.org/10.1016/J.RESS.2021.108249>.
- [74] Nordström J, Goerlandt F, Sarsama J, Leppänen P, Nissilä M, Ruponen P, et al. Vessel TRIAGE: A method for assessing and communicating the safety status of vessels in maritime distress situations. *Saf Sci* 2016. <https://doi.org/10.1016/j.ssci.2016.01.003>.
- [75] Ruponen P, Manderbacka T, Lindroth D. On the calculation of the righting lever curve for a damaged ship. *Ocean Eng* 2018;149:313–24. <https://doi.org/10.1016/J.OCEANENG.2017.12.036>.
- [76] Ruponen P, Lindroth D, Routi A-L, Aartovaara M. Simulation-based analysis method for damage survivability of passenger ships. *Ship Technol Res* 2019;66:180–92. <https://doi.org/10.1080/09377255.2019.1598629>.
- [77] IMO. Damage stability of cruise passenger ships: Monitoring and assessing risk from operation of watertight doors. London: Submitted by the Cruise Lines International Association (CLIA); 2014. MSC 93/6/9.
- [78] IMO. Damage stability of cruise passenger ships: Simplified calculation of the attained subdivision index A. London: Submitted by the Cruise Lines International Association (CLIA). MSC 93/6/8; 2014.
- [79] Spanos DA, Papanikolaou AD. On the time dependence of survivability of ROPAX ships. *J Mar Sci Technol* 2012;17:40–6. <https://doi.org/10.1007/S00773-011-0143-0/FIGURES/8>.
- [80] Tagg R, Tuzcu C. A performance-based assessment of the survival of damaged ships: final outcome of the EU Research Project HARDER. *Marine Technol SNAME News* 2003;40:288–95. <https://doi.org/10.5957/MTI.2003.40.4.288>.
- [81] Hirdaris S, Montewka J, Zhang M, Taimuri G, Hinz T, Ruponen P. Extreme scenarios and scenario modelling. Deliverable 3.1. Flooding Accident REsponse - FLARE, Grant No 814753. Finland: Espoo; 2019.
- [82] Luhmann H. Concept Ship Design B. FLOODSTAND Integrated flooding and standard for stability and crises management. Project No P7-RTD- 218532. 2009.
- [83] Ruponen P, Pennanen P, Manderbacka T. On the alternative approaches to stability analysis in decision support for damaged passenger ships. *WMU J Maritime Aff* 2019;18:477–94. <https://doi.org/10.1007/S13437-019-00186-8/FIGURES/8>.
- [84] Baldauf M, Benedict K, Fischer S, Motz F, Schröder-Hinrichs J-U. Collision avoidance systems in air and maritime traffic. *Proc Inst Mech Eng Part O* 2011; 225:333–43. <https://doi.org/10.1177/1748006x11408973>.
- [85] Bulian G, Lindroth D, Ruponen P, Zaraphonitis G. Probabilistic assessment of damaged ship survivability in case of grounding: development and testing of a direct non-zonal approach. *Ocean Eng* 2016;120:331–8. <https://doi.org/10.1016/J.OCEANENG.2016.02.018>.
- [86] Bulian G, Cardinale M, Dafermos G, Lindroth D, Ruponen P, Zaraphonitis G. Probabilistic assessment of damaged survivability of passenger ships in case of grounding or contact. *Ocean Eng* 2020;218:107396. <https://doi.org/10.1016/J.OCEANENG.2020.107396>.