



ELSEVIER

Contents lists available at [ScienceDirect](https://www.sciencedirect.com)

# Transportation Research Part E

journal homepage: [www.elsevier.com/locate/tre](http://www.elsevier.com/locate/tre)

## A model for agribusiness supply chain risk management using fuzzy logic. Case study: Grain route from Ukraine to Poland

Ievgen Medvediev<sup>a,b,\*</sup>, Dmitriy Muzylyov<sup>c</sup>, Jakub Montewka<sup>a</sup><sup>a</sup> Faculty of Mechanical Engineering and Ship Technology, Gdansk University of Technology, Gdansk, Poland<sup>b</sup> Faculty of Transport and Construction, Volodymyr Dahl East Ukrainian National University, Kyiv, Ukraine<sup>c</sup> Faculty of Economic Relations and Finance, State Biotechnological University, Kharkiv, Ukraine

### ARTICLE INFO

#### Keywords:

Supply chain sustainability  
 Grain cargo transportation  
 Membership function  
 Fuzzification  
 Simulation  
 Mode of transport  
 Delivery conditions  
 Multimodal transportations

### ABSTRACT

In order to establish new logistics routes, it is necessary to address several technical and organizational issues, among others. One of the most important criteria for evaluating the performance of a supply chain is the delivery time, proactive consideration of potential hazards and associated uncertainties that may occur along the route. However, the existing solutions are often passive and reactive, based on statistics, thus not leaving much room for proactive risk mitigation measures. Therefore, there is a need for a foreseeing modern approach to account for the impact of anticipated hazards on delivery time. The aim of this study is to develop a model for determining delivery time considering expected risk factors (RF), based on mathematical tools of fuzzy logic and actual background knowledge elicited from the literature and experts. The paper identifies primary technical and operational hazards that occur during loading and transport and converts them into risk factors. The risk factors are then quantified and fed into a fuzzy model developed with the Matlab Fuzzy Logic Toolbox and assembled in the Simulink environment. The application of the model is demonstrated in three case studies reflecting three potential grain supply chains (SC) from Ukraine to Poland: classical transport by rail grain hoppers (SC1); transport by containers on railway platforms (SC2); transport by bulk grain trucks (SC3). The resulting travel time for the analysed SCs is between 49 and 71 h for SC1, between 45 and 62 h for SC2 and between 42 and 62 h for SC3. In addition, the outliers of the travel time values beyond the 1.5 quantiles were defined according to the uncertainty band. The results of the fuzzy model were compared with the results of the deterministic approach in the concurrent validation and a good agreement was found. This proves the appropriateness of the fuzzy model calculations and the possibility of using alternative SCs in grain delivery. The main benefit of the proposed model is a new universal tool based on a holistic and active approach to risk assessment using fuzzy logic.

### 1. Introduction

Ensuring safe and appropriate use of safety-critical systems is essential for communities and stakeholders. Such a system can be exemplified by the agribusiness supply chains that stretch across Europe, connecting sources in Eastern Europe with sinks in Central

\* Corresponding author at: at: Gdansk University of Technology, Faculty of Mechanical Engineering and Ship Technology, Narutowicza 11/12, Building 30, room 222, Gdansk 80-233, Poland.

E-mail address: [ievgen.medvediev@pg.edu.pl](mailto:ievgen.medvediev@pg.edu.pl) (I. Medvediev).

<https://doi.org/10.1016/j.tre.2024.103691>

Received 28 October 2023; Received in revised form 30 July 2024; Accepted 30 July 2024

Available online 12 August 2024

1366-5545/© 2024 The Authors. Published by Elsevier Ltd. This is an open access article under the CC BY-NC license (<http://creativecommons.org/licenses/by-nc/4.0/>).

and Southern Europe. The functioning of such systems can be influenced by various factors of different dynamics, which can be categorised as endogenous (e.g. technical, operational) and exogenous (e.g. environmental, political). The numerous initial challenges in logistics are caused precisely by operational and technical hazards. The first type includes disruptions in the interaction of different modes of transport, delays at customs terminals, deviations from transport plans, and other related problems. Technical hazards in logistics are mainly associated with breakdowns of vehicles, handling mechanisms, etc. All these aspects increase uncertainty in the supply chain and, therefore, need to be properly recognised. This is helpful for the development of an appropriate risk assessment model. One of the tasks of the proposed study is to accurately identify various hazards based on expert opinions. According to expert knowledge elicitation, it is essential to highlight the most important hazards that lead to specific risk factors, thereby increasing travel time. This identification process involves conducting a survey to identify the most significant potential threats, and if needed, adding additional dangers that may also contribute to increased travel time. A specific set of hazards that characterize each supply chain's risk factor was identified by comparing expert opinions. Additionally, with the help of experts, the approximate duration of these threats can be established numerically. This information further allows for the establishment of the operational range of the fuzzy model using the fuzzification method. To consider these factors when planning operations along a supply chain, a strategy based on risk assessment is often chosen (Nocera et al., 2023; Gurtu & Johny, 2021; Tuncel & Alpan, 2010; Végsová et al., 2020; Avelar-Sosa et al., 2014). In this context, relevant hazards are identified, risks associated with them are assessed and evaluated to develop risk management solutions and facilitate decision making processes. When conducting risk analyses, various methods and tools that have specific strengths and weaknesses are used. The latter, in conjunction with the scope of the analysis and the available data, can guide the selection of a suitable method. To this end, a detailed overview of current studies on risk analysis in relation to supply chains and logistics is provided below.

Koohathongsumrit & Chankham (2023) present a hybrid model that integrates fuzzy risk assessment model (FRAM), best-worst method (BWM), and measurement of alternatives and ranking according to the compromise solution (MARCOS) approaches to select the best multimodal route based on key factors influencing decision making. Three elements are used to find the most suitable route: transport cost, transport time and an average delivery risk. However, the risk assessment is carried out indirectly and, in result, the average level of impact of the risk is given without reference to the causes, i.e. the hazards. Therefore, the model is not suitable for assessing the risks in supply chains that exist under special conditions (military confrontation, trade embargo), as the nature of the impact of technical and operational hazards is different.

Koohathongsumrit & Meethom (2021) proposed an integrated approach to determine risk variables in multimodal freight routes. The data envelopment analysis (DEA) model was initially used to convert fuzzy scale terms of risk magnitude into reliable risk magnitudes to account for uncertainties in supply. This model relies on the use of a measure, such as the overall acceptable risk magnitude. While the authors believe this measure is appropriate for current routes, it is not relevant for assessing risk in SCs operating in unique circumstances.

In their recent study, Shafiee et al. used 2022 Pythagorean fuzzy sets to account for the uncertainty associated with expert judgements. The method has important implications for managers and decision makers seeking to mitigate the risks associated with perishable product supply chain networks during the pandemic. While the approach is intriguing, it is important to note that the use of fuzzy logic is limited to evaluating the judgements of experts and reducing uncertainty in their opinions about risk. Therefore, this technique does not fully account for the imprecise nature of risks.

Ur Rehman & Ali, 2021 proposed the fuzzy technique for preference ordering by similarity to the ideal solution to find optimal transport options from the seaports of the China-Pakistan Economic Corridor to Western China. The evaluation criteria for decision making include time, cost, energy, environment and security. The presented set of risks is different from the model presented in this paper. Therefore, it has a direct impact on the structure of the fuzzy model and new evaluation principles need to be developed.

In a study by Wan et al. (2019), fuzzy rules were used as a component of Bayesian networks to assess risk factors. Their model was shown to improve the accuracy of results in situations with high-risk uncertainty compared to traditional methods. However, the study did not take into account the nature of operational risks, which are different from delivery risks and should also be considered.

Resende et al, 2023 have proposed a decision support system for risk assessment based on fuzzy rules. This approach is widely applicable due to its simplicity. The system uses fuzzy sets and fuzzy inference systems to evaluate the financial risks. However, the major drawback of this approach is the high level of abstraction associated with the passive risk assessment methods.

Pathak et al. (2020) present a comprehensive solution based on fuzzy group decision making and a fuzzy evidence method to evaluate the success of the freight transport system based on critical factors. In their method, the prioritised risks are determined on the basis of the assessment of the environmental component. Consequently, the risk assessment is based on the uncertain judgements of freight transport experts. However, this approach does not allow operational or technical risk factors to be defined.

El Jaouhari et al. (2023) designed a model for the Internet of Things that uses fuzzy set theory to solve problems related to the imprecision of language and the uncertainty of human judgements. The model assesses the threats to green warehouse logistics based on a sustainable fuzzy model with Mamdani inference and various defuzzification methods. It is noteworthy, because it uses multiple defuzzification methods to confirm its sustainability. Its emphasis on green logistics is commendable, but it cannot be applied to research questions related to risk assessment because different hazards arise from operational and technical aspects.

The integrated risk framework proposed by Aqlan & Lam (2015) includes a fuzzy inference system to calculate the total hazard number in the management parameter and predictability. This framework is an accessible and simple tool. Its fuzzy output system is used as an auxiliary model and not as a base model. Therefore, it is not fully focussed on risk assessment. The scope of application does not exactly match the operating conditions of grain supply chains.

Mu & Wan (2010) have developed an approach that uses fuzzy sets to identify a large number of common risks in the supply chain. Despite the assessment of numerous risks, the model only evaluates the presence and absence of risks to supply chain sustainability.

Therefore, it is difficult to determine the degree of impact of risks on the objective function.

Janjua et al. (2023) proposed a fuzzy inference system to evaluate supply chain risk based on results finding data using Natural Language Processing about disruption publicized on the X (formerly known as Twitter). This model identifies a huge array of risks due to publicly available information. However, the approach is only aimed at the initial assessment of risks, which allows it to be qualitatively identified. Thus, the fuzzy output model does not solve the main issue – establishing patterns between the input parameters and the output of the system.

Díaz-Curbelo et al. (2019) evaluate the uncertainty of input factors to better understand vagueness of processes in supply chains using a fuzzy method. In this case, fuzzy logic facilitates the treatment of ambiguous data from different domains and scales. The proposed fuzzy model does not take into account the duration and dynamics of risk events. In our opinion, this is a gap in risk assessment in existing supply chains.

Existing risk assessment approaches in agricultural commodity supply chains are based on the classical approach associated with the probability of negative events based on historical data along a given supply chain and the resulting economic losses (Aven, 2012; Girdžiūtė, 2012; Arcese et al., 2023; Pohudina et al., 2021; Jankelova et al., 2017). Such an approach makes it possible to learn from past accidents, but it does not take into account the dynamics of operational parameters, such as delays along a multimodal supply chain and their causes, nor the factors that lead to the adverse events that can be actively mitigated (McDougall et al., 2022; Waqas et al., 2023).

The possibility of proactively assessing risks arises from the fact that the model takes into account the factors (transport disruptions, errors at customs, various mishaps, etc.) that directly affect the analysed process. Knowing their presence and impact is therefore essential for planning and developing corrective actions. In addition, it is important to proactively assess the risk when organizing the delivery of goods through supply chains. In this way, it is possible to determine how the delivery time will be affected if the risks have not yet materialised. Proactive assessment differs from passive assessment in that it assesses risks before they occur, rather than relying on statistical information whether a risk has materialised or not. Various mathematical tools can be used for proactive risk assessment, such as fuzzy logic, neural network modelling, digital twins or blockchain technologies such as NFTs.

The importance of a holistic approach that considers technical, operational and ergonomic elements when assessing risks in the agri-food supply chain is evidenced in the literature, see for example (Zhao et al., 2017; Kiyko et al., 2020; Tomasiello & Alijani, 2021). However, it does not show how these aspects should be linked together along the entire supply chain. Some examples of semi-holistic and active approaches do exist, however, they are limited to unimodal supply chains, such as road transport of bulk commodities in containers (Li et al., 2023; Muzylyov & Shramenko, 2020), or only concern selected elements of a supply chain, such as loading and unloading stations (Vafadarnikjoo et al., 2023; Medvediev et al., 2020a; Anufriyeva et al., 2023) or port terminals (Liao et al., 2023; Xu et al., 2023; Sun et al., 2023). As logistics chains for safety-critical goods are characterised by various threats and hazards (Sharma et al., 2021; Fan et al., 2023), appropriate modelling techniques must be used to account for those. For this purpose, fuzzy logic is used as a modelling tool (Choudhary et al., 2023a; Zandi et al., 2020). However, these models are theoretical in nature and are not mature enough to be applicable in the daily practice of risk management (Choudhary et al., 2023b).

In a highly dynamic environment, facing political and social disruptions such as pandemics or wars, the approach to risk assessment based on statistics and historical data, which does not take into account real conditions affecting the flow of cargo along the supply chain, may be outdated. This is mainly because the obtained results are not adapted to the changing environment and are, therefore, not suitable for decision-making. The main drawback of the approaches proposed so far is insufficient consideration of hazards related to supply chain operations, inadequate treatment of uncertainties, the lack of assessment of the importance of variables and a superficial approach to risk assessment in general. As the majority of current risk assessment approaches are passive and do not allow active risk mitigation measures, and often only allow selective risk assessment along the entire supply chain, there is a need for a holistic and active risk assessment approach. This demand can also be seen in more recent literature. Choi (2020), for example, calls for research into data-driven decision-making and logistical processes in order to accelerate decision-making processes through the prudent use of information and to enable the use of rapid response tactics.

Therefore, in this paper the authors propose a holistic risk assessment model that takes into account technical and operational aspects of agricultural commodity supply chain in a dynamic way, reflecting the actual supply-demand relationships between source and sink, and the factors that determine the flow of commodities along the chain. To cope with the uncertainties involved, the model is developed using actual supply and demand data, expert knowledge and the results of system model simulations. The proposed model will help to address the technical and operational risks identified by experts that can lead to longer delivery times in the agricultural supply chain. To this end the following research questions are formulated and addressed in the sections of the paper specified below:

RQ 1: How to identify operational and technical hazards and their impact on the travel time in new agri-food supply chains?

RQ 2: How to select a group of experts to identify potential risks and collect data in agri-food supply chains?

RQ 3: How to choose a fuzzy model structure that calculates the travel time based on the identified risk factors?

RQ 4: How can the developed fuzzy model be applied in a real scenario, such as grain supply chains, and what insights can be gained for the used case of food supply chains on the example of multimodal transport from Ukraine to Poland?

RQ 5: How can the proposed fuzzy model be verified in the absence of suitable methods for solving the problem?

Existing approaches cannot be applied to the research questions of risk assessment in agri-food supply chains due to the oversimplification of the models, the lack of causal links between the hazards and risks themselves and the high level of abstraction. Also, the uniqueness of the situation in the establishment of new supply chains does not allow previous studies to be fully utilised. The novelty proposed here is a new model for proactively assessing risks in the supply chain. The model aims to identify the root causes of risk situations (hazards) and define dependencies on extended delivery times along the entire supply chain. The model facilitates the search for the best route in terms of minimum delivery time based on possible technical and operational risks under fuzzy conditions.

This has not yet been achieved by any of the existing approaches. Fuzzy logic is used as the mathematical formalism for the development of the risk model, which is suitable for dealing with the associated uncertainties and has the following advantages over other methods:

1. It allows to easily create a pattern between fuzzy input variables and result function;
2. No recalculation of the probability of occurrence or the regression coefficients is required when the input values change;
3. The calculation requires a small data set, as it only needs linguistic variables characterising the input parameters, so that the calculation can be performed without meaningful statistics.

The latter is particularly promising for risk assessment, which is usually subject to a certain degree of uncertainty.

Here, risk is measured as a deviation from the expected delivery time for each supply chain, taking into account technical and operational hazards at each stage of the supply chain. Therefore, the model can be used to compare different supply chains and select the one that fulfils the efficiency and risk criteria. This can have a positive impact on transport planning and improve the overall efficiency of the transport process. The model can be used by managers, executives and logisticians of transport companies as an analysis tool for effective organisation and planning of the transport process of agricultural commodity supply.

The model was tested on three chains for grain deliveries from Ukraine to Poland. This case was chosen because supply chains are critical to maintaining food safety around the world. This is evident from reports by international organisations such as the UN and the European Commission ([Ukrainian grain exports explained, 2023](#)).

The aim of this study is, therefore, to develop a model for determining the delivery time, taking into account risk factors, based on mathematical tools of fuzzy logic and current background knowledge, including the knowledge of experts.

The paper is structured as follows: [Section 1](#) reviews the relevant literature on risk assessment approaches in Supply Chains and Logistics by fuzzy logic and fuzzy set theory or their combinations. [Section 2](#) describes the methodology used and the data used. [Section 3](#) demonstrates the applicability of the developed model through a case study. [Section 4](#) presents the results obtained and their validation. [Section 5](#) discusses the findings, while [Section 6](#) concludes the paper.

## 2. Definitions, methods and data

### 2.1. Risk definition

For the purposes of this paper, the authors adopt a definition of risk as set out in the International Standards for risk management ISO 31000, (ISO, 2018), where risk is expressed as *the impact of uncertainty (U) on objectives*. The objective in this study is the operational side of the supply chain, namely the turnover of goods within the specified time (t). Other aspects of this turnover, such as costs or carbon emissions, are not considered, or they are non-operational aspects, e.g. warehousing. In the study, warehousing issues were not considered due to the focus on risks associated directly with transportation, because it is a main problem now for critically important SCs due to unique conditions. The same situation is related to spoilage in transit arising due to human factors. Consequently, the damage to the cargo during transportation practically does not depend on technical and operational hazards for a specific mode of transport. It is influenced by the level of control and safety. Therefore, it was not in the study scope. While the uncertainties are caused by the identified hazards and relate to the expected travel time, the delays may be due to technical problems, such as breakdowns of loading/unloading mechanisms or means of transport, or to operational problems, such as interaction between parties involved in the supply chain. Therefore, risk could simply be formulated as the following mathematical equation:

$$R \approx U(t) = T + \sum \Delta t \quad (1)$$

$T$  – expected travel time;  $\Delta t$  – deviation from expected time because of identified hazards at each stage of the supply chain.

Uncertainty is expressed in terms of a range around the mean value of travel time calculated as part of the randomisation process. This information can be passed on to decision-makers to assess whether the given uncertainty bandwidth may affect the objective (transshipment of goods in a predefined time window), thus facilitating a risk-informed decision-making process. Uncertainty is caused

**Table 1**

Anticipated hazards in grain supply chain.

Stages	Hazards in a given mode of Transport		
	Road	Railway	Waterway
Preparation	Lack of shippers, insufficient processing capacity, disruption to the coordinated operation of the loading point and lorry, failure of the shipper.	Lack of the required waggon, overloading of the railway depot in the search for the waggon, malfunction of the loading stations, insufficient quantity of grain per elevator.	Disturbance of the shipper's berth, insufficient quantity of grain in the harbour's grain silo, exceeding the ship's berthing time.
Transportation	Vehicle breakdowns, deviations from the planned route, partial loss of freight during transport, congestions on the delivery route, delays at the customs terminal.	Delay at intermediate stations during train formation; excessive idle time when crossing borders, delay due to the complexity of customs clearance, delays due to changing wheelsets.	Ship delay, weather-related travel delay, timetable deviation due to congestions when passing difficult sections.
Completion	Vehicles idling near the port, malfunctions in the unloading mechanism, a lack of handling capacity, a busy grain silo and lorry breakdowns in the port.	Overcrowding on the unloading front, insufficient railway capacity during unloading and train cancellations.	Lengthy customs procedure, failure of unloading equipment, lack of space at the consignee's grain silo when the ship arrives.

by the hazards posed by two aspects of the transport system analysed here, namely the technical and the operational one (Shakhov et al., 2021). The latter refers to the availability and reliability of the transport system's infrastructure and the elements of the transport system, while the former aspect covers the administrative part of the transport system. These two aspects are interlinked and reflected in the hazard identification of the transportation process, which is divided into three phases: preparation, transportation and completion, as described in Table 1. The hazards were identified by means of the expert knowledge survey and a detailed review of the main operations related to the supply technology, which are justified by the structures of the SCs. The wording of the hazards presented in Table 1 and their clarification were compared with the standards (DSTU IEC/ISO 31010, 2013; International Standards Organisation, 2020), the risk vocabulary (International Standards Organisation, 2009) and the opinion of scientists (Gołębiowski et al., 2023). Finally, uncertainty is assessed with expert knowledge and available data using fuzzy logic.

## 2.2. Modelling framework

With the modelling framework (Fig. 1) chosen here, the authors attempt to synthesise the existing knowledge about the hazards along the prospective supply chain and assess their impact on travel time. Therefore, in the first phase, they identify the hazards that may have an impact on travel time, considering operational, technical and environmental aspects. For this purpose, the knowledge of the experts is used. The general modelling framework used in this paper is shown in Fig. 1.

Then, these hazards are transformed into risk factors through a process of parameterisation, supported by the experts and using official databases and publicly available data. Subsequently, the risk factors are aggregated, and the risk is expressed in terms of intervals. Afterwards, the mathematical modelling with the use of fuzzy logic is employed to obtain the risk estimates for each analysed supply chain. Finally, the validation framework is defined and applied to the developed model to justify the suitability of the chosen modelling approach for the given purpose.

## 2.3. Description of the analysed supply chains

In this study, the authors consider three major supply chains (SC), two of which are based on rail transport and one on road transport. A generic description of each SC is given below, with the intention to introduce the overall idea, its foundations and major elements that the analysed SC comprise with. The detailed description of specific routes and specific SC is given in the Chapter 4.

In the first supply chain analysed (SC1), bulk cargo is transported by rail, as shown in Fig. 2. The freight is transported in special grain waggons, which make it possible to transport large amounts of freight in one trip. However, the main disadvantage is that a fleet

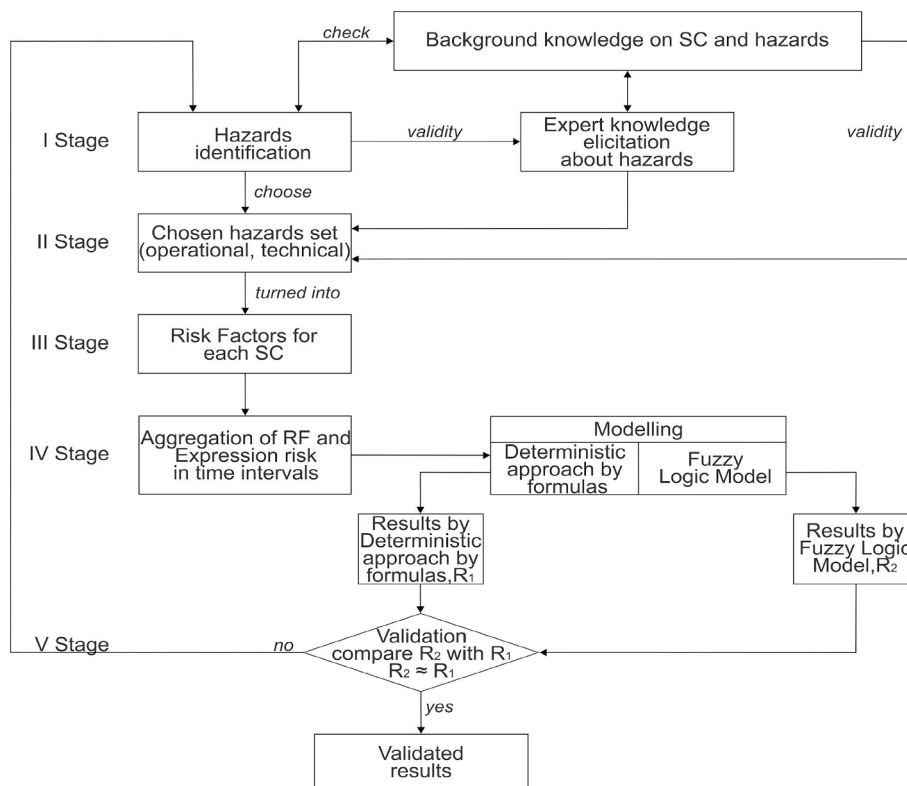

Fig. 1. General modelling framework.

of special vehicles is required and the waiting time at the border is considerable due to the need to change wheelsets, caused by a difference in the track gauge (Volkov et al., 2020).

The second supply chain (SC2) also uses rail to deliver grain cargo, however in this case the cargo is transported in containers loaded onto waggons-platforms, as depicted in Fig. 3. The advantage of SC2 is a quick transfer of the containers to European-gauge waggon-platforms. Consequently, the border crossing time is reduced, which significantly shortens the overall travel time. However, the disadvantage of this scheme is a large number of containers required to haul the same load of cargo. Therefore, during one turnover, a smaller batch of grain is exported.

The third supply chain (SC3) is based on road transport, as shown in Fig. 4. In this case, both individual grain transporters and specialised road trains are used. The main advantage is a minimal border crossing time compared to the first two supply chains. This is due to the duration of customs clearance for road transport (Lebid et al., 2022; Lebid et al., 2023). The disadvantages include small shipment volumes and high costs. However, this is offset by the mobility and ease of finding rolling stock compared to rail transport.

#### 2.4. Data origin

The following data is used during the modelling process:

- 1) Data on the duration of grain delivery clarified by validating the routing using online mapping. This time is given without considering delays in loading and unloading operations and the time needed for customs clearance.
- 2) Data on expected deviations and delays on the route by road transport, obtained during experts' knowledge elicitation process.
- 3) Data on customs clearance in relation to waiting time at borders (check-points), (Eurostat, 2023).
- 4) Data on potential time deviations for each hazard and waiting times for each mode of transportation in a multimodal supply chain are obtained from official Internet portals (Polska, 2022).

#### 2.5. Methods

The following research methods and procedures are applied in this study:

- 1) Expert knowledge gathering methods enable the acquisition of data: on normative time values for each process operation in the supply chain; on customs clearance time, hazard types, etc. A contact survey is conducted for this purpose.
- 2) The deterministic approach is used to mathematically formalise the risk factors present in the supply chain based on expert knowledge. The authors have developed simplified formulae (Appendix A) that describe the impact of operational and technical hazards identified by experts on specific risk factors that may occur at each stage of the supply chain.
- 3) The fuzzy logic method is used to formalise the membership functions and concept sets according to risk factors to develop a logical-linguistic model.
- 4) Validation framework allows providing face validity for a model, assessing its application adequacy to solve the current scientific challenge. Content validation is also used to assess the acceptability of the simulation results obtained. Predictive validation tests the ability of the model to deliver the expected results. This includes stress tests, sensitivity analyses and analyses of system behaviour. Concurrent validation allows comparison of the results obtained with a fuzzy model with an alternative (deterministic) approach.
- 5) The randomisation method is used to model a set of anticipated scenarios for each supply chain based on risk factors processed by a logical-linguistic model. It provides the dispersion around the value for the multiple random tests.
- 6) The data presented in this section could be applied to the period after the Russian invasion of Ukraine. The Food and Agriculture Organisation of the United Nations report can update information on supply disruptions by logistics companies (FAO, 2023). This is useful to refine data and assess the impact of risks on travel time in the future.

The authors calculate the average extra travel time equivalent for each unit of rolling stock, including rail waggon-hopper, container, and road truck, to estimate risk impact. The labor required for each unit is nearly identical across all three supply chains, resulting in equal impacts on risk factors assessment. This is because the quantity of grain transported by each rolling stock unit is roughly the same, as explained in Chapter 4.

##### 2.5.1. Expert's knowledge elicitation

In this study the process of experts' knowledge elicitation is understood as a synthesis of information on the occurrence of hazards in the grain supply chain and delivery time deviation. The objectives of the process were as follows:

- 1) At what stage can a particular hazard occur in the supply chain?
- 2) What is the acceptable range of time deviation from the standard duration for each operation?
- 3) How can the range between the minimum and maximum values for each hazard type be determined?

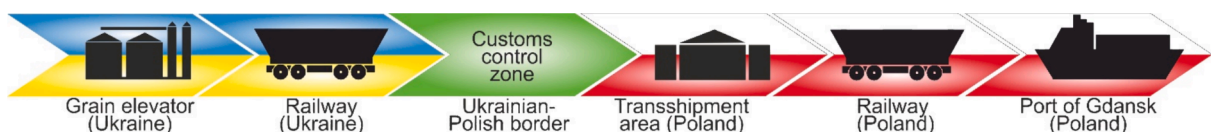

Fig. 2. Supply Chain 1 – Transportation of Grain by the Railway, with the Grain Waggon.

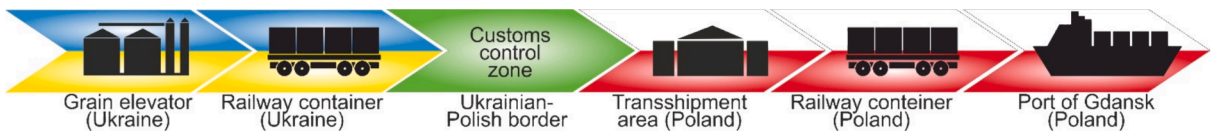

Fig. 3. Supply Chain 2 – Transportation of Grain by Rail in Containers on Flat Waggons.



Fig. 4. Supply Chain 3 – Grain Transportation by Bulk Grain Trucks and Road Trains.

4) Can you give examples of situations or factors that require the collection of expert knowledge to assess risk in grain supply chains?

The domain knowledge was elicited from the experts in the form of a survey conducted in November 2022 (drivers) – January 2024 (managers) among a group of experts directly involved in the supply chain. Drivers are often chosen as experts because they are more communicative and have quicker access to reliable expert information. Therefore, these experts can thoroughly analyse the causes of the different hazards and their impact on delivery time. Such an assessment allows for a more correct formalisation of the main hazards in grain supply chains.

The expert group consisted of seven experienced lorry drivers with at least 6 months of experience in the delivery of grain or other bulk goods on international routes – Fig. 5. They were divided into three lots according to their professional experience: experienced drivers, drivers with average experience and novices, see Fig. 5. The first lot consists of one driver with more than 5 years of experience, the second one, consisting of two respondents, includes drivers whose experience ranges from one to three years. The third lot consists of four drivers with one year of experience. The fact that only one driver is represented in the first group can be explained by the fact that international grain deliveries by road have only been offered for a relatively short time. Unfortunately, there are currently practically no drivers with significant experience in grain supply chains.

Two managers from grain export companies were consulted as experts in order to increase the reliability of the survey results, which were answered by the main group of respondents, the drivers. Experts from companies that are among the TOP-10 exporters of 2022–2023 were considered (Zharikova, 2023; Ukrainian grain exports explained, 2023). Both experts have five years of experience in exporting agricultural goods by rail (Fig. 5). These experts were also consulted to identify potential hazards in the port during unloading. To prepare the survey, data from international (International Standards Organisation, 2020; International Standards Organisation, 2018) and national (DSTU IEC/ISO 31010, 2013; State Transport Service of Ukraine, 2023) standards on risks and specific hazards in grain transport were used (Herasymenko, 2019; Fernandes et al., 2023; Digging). Based on these sources, it was possible to specify the results of the expert survey on risks in road, rail and port logistics.

The survey consisted of open and closed questions. Open questions aimed to determine the deviation time for each hazard based on the alternatives given by experts. Closed questions aimed to identify which hazards were most common in the supply chain and where were they placed in the delivery stages.

2.5.2. Fuzzy logic

Fuzzy logic was chosen as the mathematical tool for developing the model. Such a model makes it possible to take into account the

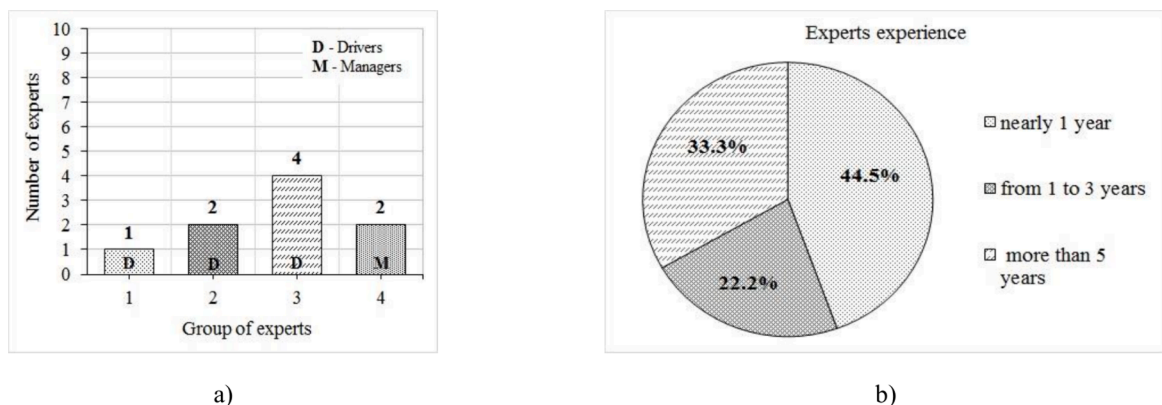

Fig. 5. Group of experts (a) and Experts' experience (b).

fuzziness and imprecision that arise when risks occur in the grain supply chain. Therefore, the hazard set is unique for each of the supply chains. This fact leads to specific risks in each SC. For this reason, fuzzy logic was developed to solve the research question in order to approximate these inaccuracies in travel time. Moreover, a set of rules for each logical–linguistic model allows the creation of a sample only for a specific type of supply chain. Therefore, the study envisages developing three models for each SC. The peculiarity of developing a logical–linguistic model is that the risk value is varied when preparing a set of initial data for future modelling. Therefore, despite the vagueness of the data, the logical–linguistic model provides a specific result that fulfils the conditions for designing new supply chains.

The fuzzy model does not require the creation of complex mathematical dependencies that describe the patterns of the effects of risk on the outcome parameter (time deviation from the standard). It is therefore sufficient to define the range for each membership function and select the model type that determines the structure and type of the resulting formula. The value of the response function (time deviation) is then calculated as a function of the specific type of risk occurring.

With simple triangular and trapezoidal membership functions, a qualitatively good result can be achieved in practical application. Therefore, they are also used in these studies (Kreinovich et al., 2020; Barua et al., 2014; Sridharan, 2021; Shtovba & Pankevych, 2018). Triangular membership functions are used in the study due to the following aspects: This type is one of the most commonly used MFs in practise (Nikolić et al., 2020), especially in the evaluation of financial, technical and operational parameters (Ngai & Wat, 2005). Moreover, triangular and trapezoidal MFs are simple in structure and understandable even for non-experts. Despite their apparent simplicity, this tool provides quite accurate calculation results and ensures the sustainability of the model (Gupta et al., 2023).

The fuzzy model blocks are implemented using the Fuzzy Logic Matlab Toolbox (Section 3.3) with the primary configuration of the member functions according to the rules. Subsequently, all blocks are combined into an overall model using the Simulink modelling environment, which calculates the travel time based on risk factors (Section 3.4).

**2.5.2.1. Advantage of fuzzy logic applied for defining the extra travel time due to specific risk factors.** The development of a fuzzy system for assessing risks associated with increased travel time is justified by the nature of the system itself. According to system theory, any supply chain is considered to be a complex or a very complex system. In the works of Hooda and Raich (2017) and Chin et al. (2018), it is recommended to use a mathematical framework of fuzzy logic to solve problems in complex technical and operational systems as it better accommodates the inaccuracy, vague, and uncertainty inherent in them. According to this, several studies (Vesely et al., 2016; Pasaribu and Syahputra, 2022; Minh et al., 2017) compare the results of fuzzy logic and regression analysis, considering the latter as one of the best probabilistic methods. Based on this, several advantages of the fuzzy model can be identified, which have become the basis for assessing the impact of risks on the response function (extra travel time) through fuzzy implementation. These aspects include:

1) Fuzzy logic does not need substantial statistics to establish a pattern between incoming parameters (risk factors) and the response function (extra travel time). Because supply chains are new and operate in unique conditions (such as military conflict), it is not possible to gather statistics on the risk factors. Therefore, solving the problem using regression analysis is impossible.

2) The extra travel time should correspond to the numerical expression of the required risk factors. However, due to constraints mentioned in point 1, this is not feasible within the problem's framework. We can estimate the range of risk factors based on deterministic calculations using expert knowledge. The quantitative characteristics obtained from these methods are necessary for setting up a fuzzy model, specifically for fuzzification, as mentioned in section 2.6 of the current work. Therefore, only a fuzzy model can be applied to obtain an adequate result.

3) The fuzzy model does not categorize factors as significant or insignificant, unlike regression analysis. In a fuzzy implementation, all indicated threats will be included in the model, and the model itself will determine the influence of each risk factor on extra travel time. Regression analysis models, on the other hand, may not take into account certain risk factors based on statistics, labelling them as insignificant, which contradicts expert opinion and does not align with the study's objectives.

4) The regression model only provides results within the specified range as defined by the statistics. The model accuracy is determined on the basis of the statistics' quality. In contrast, fuzzy implementation models do not have this limitation. Despite the high rate of uncertainty in the fuzzy model, it allows for the inclusion of subjective experiences (expert opinion) as a unique data source in its design. This capability compensates for the lack of high-quality statistics, which are often crucial. These advantages of FM correlated with the research tasks of the current study.

Considering the convenience of using fuzzy logic to solve the problem mentioned earlier, it is important to note that the numerical evaluation of risk factors and additional travel time does not oppose the principles of using fuzzy logic. This aspect gives a possibility to verify the accuracy of setting up the fuzzy model in the initial stage.

### 2.5.3. Validation

Validity in a broader sense aims to describe the results of the model and its ability to produce results in a structured way in the area under investigation (Terrin et al., 2003). This is to justify the suitability of the results obtained and the model for the given purpose.



**2.5.3.1. Face validation.** Face validation serves to justify the relevance and feasibility of the developed risk model structure for a given purpose. In the face validation process, the fuzzy model was subjected to the following requirements:

- 1) The ability to consider fuzzy data in a value range view that a risk factor can take based on a specific hazard identification.
- 2) The determination of a clear risk value for grain delivery time deviation based on a comprehensive assessment of risk factors.

This approach considers the main hazards (technical and operational) that affect the supply chain sustainability.

To determine the face validity of a model, expert judgement is used together with a literature review of existing models that serve the same purpose (Darkes et al., 1998; Pitchforth & Mengersen, 2013). However, the validation should be conducted by experts from a different group than the one that developed the model (Johnson et al., 2010, James et al., 2010).

Face validation, therefore, looks for answers to the following questions:

1) Does the structure of the model (number of blocks, input parameters and fuzzy algorithm applied) match the description in the literature and/or expert knowledge?

2) Does each input parameter of the model match the values that reflect the expert knowledge?

3) Do the risk factors entered into the model match the specific hazards described by the experts for SC?

The results provided by the model are then validated by the content validation process, which assesses the extent to which the results obtained from the model correspond to the real situation in the grain supply chain.

**2.5.3.2. Content validation.** To check the content validity of the structure, one can compare whether all factors, principles and relationships between the elements correspond to the literature and are contained in the fuzzy model (Rahman et al., 2023; Yanar & Akyürek, 2011).

In this study, the content validation of the model consists of a comparison of the results obtained with a heuristic risk assessment and a fuzzy model. Therefore, the results obtained with the logical–linguistic model should be within the range of the values obtained with the probabilistic estimation. The lack of significant deviation for each risk factor indicates that the results of the fuzzy model are appropriate and can be used for the design of grain supply chains considering technical and operational hazards as risk components (Behret et al., 2011). To assess the content validity of a fuzzy model, it is advisable to answer the following questions:

1) Does the model structure contain all identified risk factors and time variance aggregates that are relevant to the model output?

2) Does each parameter have relevant values that it can take on?

3) Is the Mamdani algorithm correctly applied to reflect the relationship between the input values and the output of the fuzzy model?

4) Are the parameters of the input values suitable for all areas known from expert knowledge?

**2.5.3.2.1. Predictive validation.** Predictive validity makes it possible to justify the ability of the model to predict not only the values of the studied parameters, but also the behaviour of the studied object (system) (Pappas & Woodside, 2021). The most common methods for performing predictive validity of a designed fuzzy model are based on answering the following questions (Turksen & Willson, 1995; Gerami Seresht et al., 2020):

1. Can the behaviour of the fuzzy model predict the behaviour of the supply chain?

2. Are the initial values of the elements of the model predictable after its execution in the comparison models?

3. Can the model, including its internal relationships, predict extreme model behaviour beyond a known range?

**2.5.3.2.2. Concurrent validity.** Concurrent validity is established by comparing the results obtained through the fuzzy model with a deterministic approach. Based on the identified hazards, the technical and operational risk factors and the range of values of the risk factors are determined using the linear formulae presented in the previous sections and in the Appendix A (parts A.1-A.3). This range of values is the reference for comparison with the results of the fuzzy model. The answers to the following questions are sought for the test of concurrent validity:

1. Do the calculation formulas in the deterministic approach contain the same parameters as the fuzzy model?

2. Do the results of the fuzzy model correspond to the results of the formulae in terms of units of measurement and range of values?

3. Is it possible to evaluate the quality of the fuzzy model calculations by comparing them with the deterministic approach?

#### 2.5.4. Randomization

Randomisation is a simple tool that generates values for the input parameters of the model according to the predefined distributions or based on observations. During the randomisation process, a possible range of input parameters is simulated and passed to the model to obtain the result in the form of an interval (Bespalov et al., 2019; Schmelzer, 2023).

Randomisation thus makes it possible to take the uncertainties of the input parameters into account and measure their effect on the model result, which in the end defines the uncertainty boundary around the model result. As a result, the fuzzy risk model shows a clear deviation time value of the grain delivery time in randomised simulated situations.

2.6. Formalisation of the set of risk factors for the supply chain (deterministic approach)

Based on the hazards defined in Table 1, several operational and technical risk factors were identified for each stage of the grain supply chain. This process was then repeated for each supply chain analysed. Formulas were found to define the risk factors in the supply chains by the technical and operational hazards identified by the experts. Presented formulas (2–4; 6–28) allow the calculation of the  $\Delta t$  for each risk factor. However, due to the fuzziness of the risk itself, the formulas cannot be used as a basic approach to establish a pattern between the risk factors and the time extension of delivery due to hazards. The results of the deterministic calculation are used in the calculation of errors based on the results of the fuzzy model of the initial configuration for the purpose of concurrent validity.

2.6.1. Supply chain 1

The risk factors anticipated for Supply Chain 1 are shown in Fig. 6 and explained below. Eleven risk factors are defined therein and they are distributed among the three stages of the supply chain as follows.

First, in the stage of cargo preparation two risk factors are anticipated:  $RF_1^r$  – the breakdown of the grain loader at the dispatch point and  $RF_2^r$  – wagon downtime caused by errors in the planning of the interaction between the railway and the dispatch point and by external factors (accidents, unavailable routes). In a stage of transportation seven risk factors are defined, three of which are on the side of the country of origin of the freight:  $RF_4^r$  – due to delays in train formation at intermediate stations (country of origin);  $RF_5^r$  – due to disruptions during transportation,  $RF_6^r$  – due to customs procedures in multimodal transportation. The remaining four are on the side of the country receiving the cargo:  $RF_7^r$  – due to wheelset handling caused by the difference in gauge width in Ukraine and European countries;  $RF_8^r$  – due to delays at the transshipment point at the border;  $RF_9^r$  – breakdown of grain handling facilities;  $RF_{10}^r$  – due to delays in train formation at intermediate stations (country of destination). Finally, at the completion stage, two risk factors are assumed as follows:  $RF_1^m$  – considers operational unavailability of port facilities at the time of cargo arrival;  $RF_2^m$  – intermittent cargo flow at the port.

Based on Fig. 6, a set of risk factors attributed to supply chain 1 can be expressed as follows:

$$R_{SupplyChain1} = f(RF_1^r, RF_2^r, RF_4^r, RF_5^r, RF_6^r, RF_7^r, RF_8^r, RF_9^r, RF_{10}^r, RF_1^m, RF_2^m) \Rightarrow T_{SC1}^{delivery} \tag{2}$$

where  $T_{SC1}^{delivery}$  – delivery time for the SC1, [hrs].

The mathematical definitions of each risk factor for supply chain 1 are presented in Appendix A (part A.1).

2.6.2. Supply chain 2

The risk factors anticipated for SC 2 are depicted in Fig. 7 and explained below. Therein 11 risk factors are defined and distributed along the three stages of the supply chain in the following manner. First, at the stage of cargo preparation all the risk factors as in SC1 are present are one additional  $RF_3^r$  – due to failure in timely preparation of containers for shipment. Next, at the stage of transportation six risk factors are defined, three on the side of the country of cargo origin, as in SC1 ( $RF_{4,6}^r$ ) and another three ( $RF_{8-10}^r$ ) on the side of the country receiving the cargo, like SC1 but excluding  $RF_7^r$ .

Finally, at the stage of completion two risk factors are assumed as follows:  $RF_1^m$  and  $RF_3^m$  – delay due to failure of the port loader breakdown.

Two container types are anticipated here: 20 and 40ft long.

Based on Fig. 6, a set of risk factors attributed to supply chain 2 can be expressed as follows:

$$R_{SupplyChain2} = f(RF_1^r, RF_2^r, RF_3^r, RF_4^r, RF_5^r, RF_6^r, RF_8^r, RF_9^r, RF_{10}^r, RF_1^m, RF_3^m) \Rightarrow T_{SC2}^{delivery} \tag{3}$$

where  $T_{SC2}^{delivery}$  – delivery time for the Grain SC2, [hrs].

The mathematical definitions of each risk factor for supply chain 2 are presented in Appendix A (part A.2).

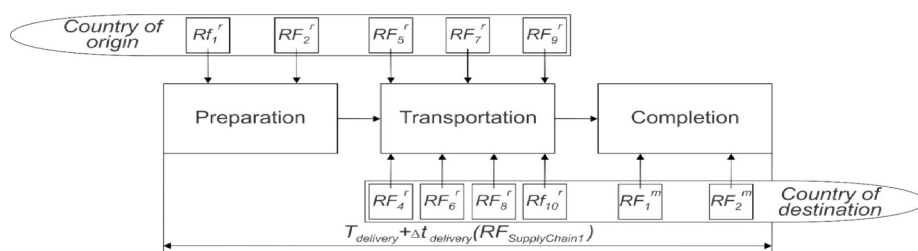

Fig. 6. Attribution of Risk Factors to the Three Stages of the Supply Chain 1.

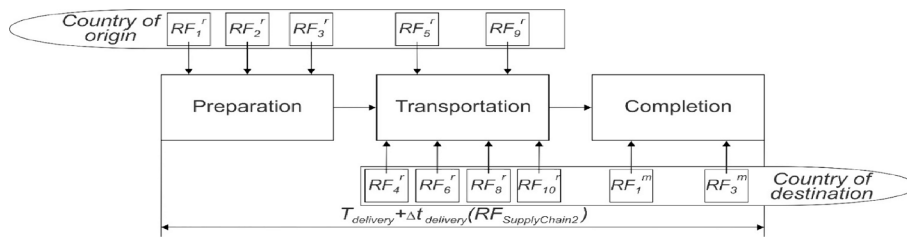

Fig. 7. Attribution of risk factors to the three stages of the Supply Chain 2.

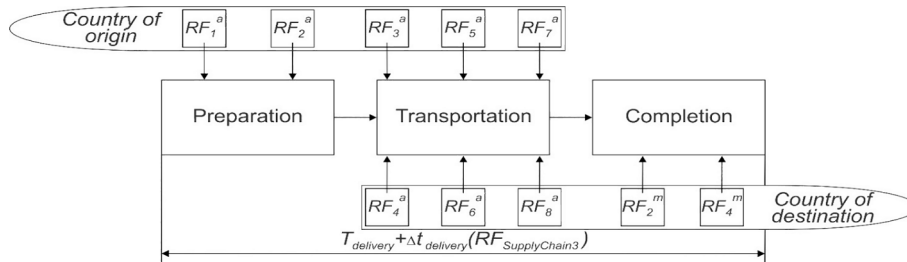

Fig. 8. Attribution of risk factors to the three stages of the Supply Chain 3.

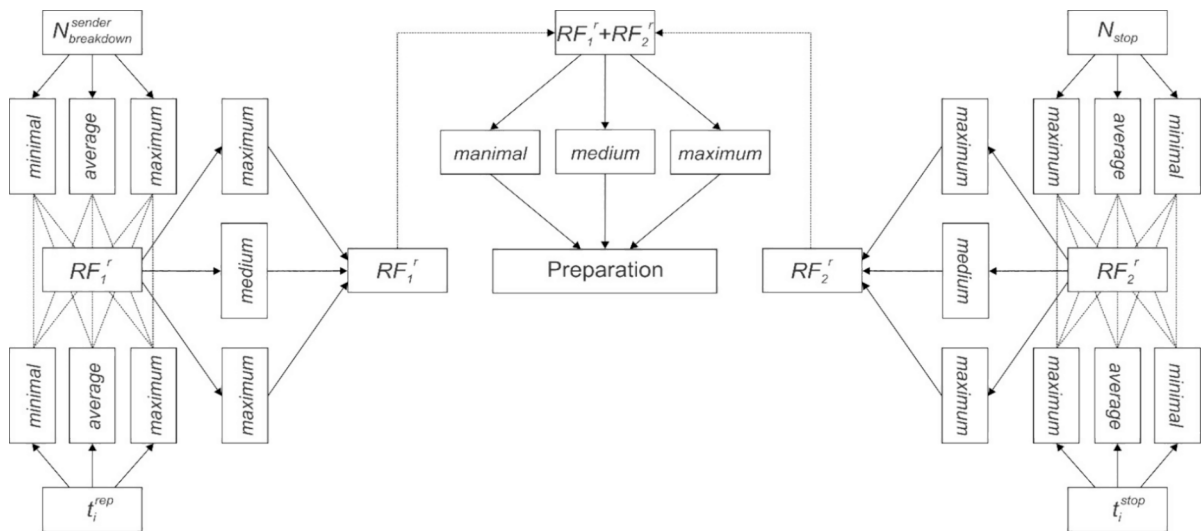

Fig. 9. Structural Model of the Interrelationships of Risk Factors in Risk Assessment (Supply Chain 1).

2.6.3. Supply chain 3

The risk factors anticipated for SC3 are presented in Fig. 8 and explained below. Ten risk factors are defined, which are distributed across the three stages of the supply chain as follows. First, at the stage of cargo preparation two risk factors are anticipated:  $RF_1^r$  – risk of the loader breakdown and  $RF_2^r$  – failure of coordination between cargo and vehicle dispatch point. In the next stage of transportation six risk factors are defined, three of them – on the side of the country of origin of the cargo:  $RF_3^r$  – due to technical defects in the road transport stage;  $RF_4^r$  – deviations from the planned route,  $RF_5^r$  – due to delays in the custom clearance; and three on the side of the country receiving the freight: ( $RF_6^r$  – due to congestion at the border;  $RF_7^r$  – due to vehicle breakdowns and  $RF_8^r$  – due to vehicles with

reduced speed on the  $i$ -th section of the route). Finally, at the completion stage, two risk factors are assumed as follows:  $RF_2^m$  – due to the unavailability of the port warehouse to receive the cargo and  $RF_4^m$  – due to lorry congestion on arrival at the port.

Based on Fig. 8, a set of risk factors attributed to supply chain 3 can be expressed as follows:

$$R_{SupplyChain_3} = f(RF_1^a, RF_2^a, RF_3^a, RF_4^a, RF_5^a, RF_6^a, RF_7^a, RF_8^a, RF_2^m, RF_4^m) \Rightarrow T_{SC_3}^{delivery} \tag{4}$$

where  $T_{SC_3}^{delivery}$  – delivery time for the Grain SC 3, [hrs].

The mathematical definitions of each risk factor for supply chain 3 are presented in Appendix A (part A.3).

Once the risk factors have been parametrized, they are aggregated, and reasoning is carried out with the model presented in the next section.

### 3. Model

The visual interpretation of the structural model describing the relationships between the input risk factors and the response function, and their partitioning options for one of the stages of SC is shown in Fig. 9. Here, the risk factors are stratified, i.e. the parameters are divided into dependent and independent, and the specific values are assigned to the term – sets. The term sets consist of numerous RFs containing linguistic values or terms defined via a general set, (Bede, 2013; Cintula et al., 2021; Zadeh, 2009; Rodríguez et al., 2011).

In this way, it is possible to follow the progression of the dependence of the risk factors on the values of the linguistic variables into which the input factors are divided. The same principle applies to other stages of the supply chain presented in this paper.

The process of mathematical model development used here consists of two levels – structural identification and parametric identification. At the structural identification level, the following is determined: 1. the structure of the model and its parameters; 2. the quantities for the parameters; 3. the heuristics for developing the model that allow conclusions to be drawn; 4. the amount of

**Table 2**  
Aggregation of Risk Factors and Expression risk in time intervals for the SC 1–3.

Supply Chain 1			Supply Chain 2			Supply Chain 3		
Symbol	Value		Symbol	Value		Symbol	Value	
$RF_1^c$	min	med	$RF_1^c$	max	min	$RF_1^c$	min	med
	70	130		190	70		70	130
$RF_2^c$	min	med	$RF_2^c$	max	min	$RF_2^c$	min	med
	70	130		190	70		70	130
$RF_4^c$	min	med	$RF_3^c$	max	min	$RF_3^c$	min	med
	70	130		190	30		70	130
$RF_5^c$	min	med	$RF_4^c$	max	min	$RF_4^c$	min	med
	70	130		190	70		50	60
$RF_6^c$	min	med	$RF_5^c$	max	min	$RF_5^c$	min	med
	400	900		1600	70		400	900
$RF_7^c$	min	med	$RF_6^c$	max	min	$RF_6^c$	min	med
	250	500		700	400		100	300
$RF_8^c$	min	med	$RF_8^c$	max	min	$RF_7^c$	min	med
	30	50		70	30		70	130
$RF_9^c$	min	med	$RF_9^c$	maxi	min	$RF_8^c$	min	med
	70	130		190	70		20	40
$RF_{10}^c$	min	med	$RF_{10}^c$	max	min	$RF_2^m$	min	med
	30	50		70	30		30	50
$RF_1^m$	min	med	$RF_1^m$	max	min	$RF_4^m$	min	med
	30	50		70	30		70	130
$RF_2^m$	min	med	$RF_3^m$	max	min	–	–	–
	30	50		70	30		–	–

Notes to the Table 2:  $RF_1^c$  – the breakdown of the grain loader at the dispatch point;  $RF_2^c$  – waggon downtime caused by errors in the planning of the interaction between the railway and the dispatch point and by external factors (accidents, unavailable routes);  $RF_3^c$  – due to failure in containers’ preparation for shipment in time;  $RF_4^c$  – due to delays in train formation at intermediate stations (country of origin);  $RF_5^c$  – due to disruptions during transportation,  $RF_6^c$  – due to customs procedures in multimodal transportation;  $RF_7^c$  – due to wheelset handling caused by the difference in gauge width in Ukraine and European countries;  $RF_8^c$  – due to delays at the transshipment point at the border;  $RF_9^c$  – breakdown of grain handling facilities;  $RF_{10}^c$  – due to delays in train formation at intermediate stations (country of destination);  $RF_1^m$  – risk of the loader breakdown and  $RF_2^m$  – failure of coordination between cargo and vehicle dispatch point. In the next stage of transportation six risk factors are defined, three of them – on the side of the country of origin of the cargo:  $RF_3^a$  – due to technical defects in the road transport stage;  $RF_4^a$  – deviations from the planned route,  $RF_5^a$  – due to delay caused by the custom clearance; and three on the side of the country receiving the freight:  $RF_6^a$  – due to congestion at the border;  $RF_7^a$  – due to vehicle breakdowns and  $RF_8^a$  – due to vehicles with reduced speed on the  $i$ -th section of the route;  $RF_1^m$  – takes into account operational unavailability of port facilities at the time of cargo arrival;  $RF_2^m$  intermittent cargo flow at the port;  $RF_3^m$  – due to failure of the port loader breakdown;  $RF_4^m$  – due to lorry congestion on arrival at the port.

min – minimal, med – medium, max – maximum.

background knowledge required for the respective analysis (Medvediev et al., 2020a; Medvediev et al., 2020b).

The following steps are taken at the parametric system identification level:

1. Aggregation of the risk factors to express the risk as an interval for each supply chain.
2. The fuzzification of the system parameters, i.e. the representation of the fuzzy values of the dependent and independent parameters by linguistic truth values.

The fuzzy inference of the Mamdani model is used to develop the rules for the model determined by the experts (Izquierdo & Izquierdo, 2018).

1. Development of a model in Simulink for direct inference of risk based on the input values.
2. Development of result sets.
3. Validation of the result.

### 3.1. Aggregation of the risk factors to express the risk as intervals for SC 1–3

When aggregating risk factors, the specificities of road and rail transport and their main differences should be taken into account, which affects the values that linguistic variables can take (Prokudin et al., 2018; Prokudin et al., 2022; Vorkut et al., 2019). In addition, the variance of the parameters describing the analysed process is lower in rail transport compared to other modes of transport. The results of the aggregation of the risk factors are shown in Table 2. Table B1 (Appendix B) breaks down the RFs into the parameters that are further used in the simulations.

When aggregating the risk factors for SC2, some of the risks are represented by a similar set of linguistic variables with the corresponding values as described in SC 1. For the aggregation of the remaining risk factors, information from interview results and analyses of previous studies was used (Pavlenko et al., 2023a; Denys, 2021).

The initial fitting of the fuzzy model uses data on the impact rate, the duration of the hazard cause and the influence of the resulting risk factor, as shown in Tables 2 and B1 (Appendix B). It is important to note that the range of data may vary. This is due to the risk itself, the occurrence of which is only vaguely described. Therefore, the tuned fuzzy model can immediately adapt to an extended range of data. This is the advantage of a fuzzy model over alternative methods such as regression analysis. In regression, the coefficients must be recalculated when the input data changes, in order to check the significance of the factors and their influence on the response function. Such manipulation is not necessary with a fuzzy model in which linguistic variables are used. These can then go beyond the redistributions of the data shown in Tables 2 and B1 (Appendix B).

### 3.2. Fuzzification

In the next phase, the fuzzification method (Teodorović and Vukadinović, 1998) is applied to dependent and independent parameters to determine the specific values for each membership function that it can assume under certain conditions. In this way, the expected variability of the risk factors present in the supply chains is expressed in an analytical form. The degree of influence of a particular risk factor on the response function is also assessed. This enables the timely development of appropriate mitigation measures to reduce the negative impact of risk situations in the delivery of grain through a particular supply chain option.

For this purpose, the fuzzy logic of Matlab is used and the equation (Fig. 10) (Appendix C) is adopted. The result of fuzzification in the Matlab membership function simulation environment is shown in Fig. 10.

The application of triangular and trapezoidal membership functions, as shown in Fig. 10, makes a fuzzy model simple and suitable for the given purpose when there are numerous input factors. The latter increase the complexity of the fuzzy model, which in turn complicates the implementation of the model. Therefore, it is desirable to develop a model that has a simpler structure without a significant loss of information. The triangular and trapezoidal membership functions used in SC1-3 make this possible (Dubinin & Kuksova, 2019; Rehman et al., 2020).

Expert knowledge was used to establish the data in Tables 2 and B1 (Appendix B) and for designing membership functions (MF) in Fig. 10. This Figure shows the MFs as inequality systems for the two incoming variables ( $t_i^{rep}$ ,  $N_{breakdown}^{sender}$ ) and the response function ( $RF_i$ ).

$t_i^{ep}$ (min, average, max)	$\mu(u)$	$\mu(u)$	$\mu(u)$	$R_{F_i}$ (min, med, max)
<p>Minimum:</p> $\begin{cases} 0, & u \leq 0 \\ D^3D \pm D^3/4 u \geq 90 \\ 1, & 0 \leq u \leq 60 \\ \frac{90-u}{90-60} = \frac{u-75}{45}, & 60 \leq u \leq 90 \\ 0, & u \leq 75 \\ D^3D \pm D^3/4 u \geq 165 \\ \frac{u-75}{120-75} = \frac{u-75}{45}, & 75 \leq u \leq 120 \\ \frac{165-u}{165-120} = \frac{165-u}{45}, & 120 \leq u \leq 165 \\ 1, & 180 \leq u \leq 200 \\ \frac{u-150}{180-150} = \frac{u-150}{30}, & 150 \leq u \leq 180 \\ 180-150 = 30 \end{cases}$	<p>Minimum:</p> $\begin{cases} 0, & u \leq 0 \\ D^3D \pm D^3/4 u \geq 3 \\ 1, & 0 \leq u \leq 2 \\ \frac{3-u}{3-2} = \frac{3-u}{1}, & 2 \leq u \leq 3 \\ 0, & u \leq 2.5 \\ D^3D \pm D^3/4 u \geq 5.5 \\ \frac{u-2.5}{4-2.5} = \frac{u-2.5}{1.5}, & 2.5 \leq u \leq 4 \\ \frac{5.5-u}{5.5-4} = \frac{5.5-u}{1.5}, & 4 \leq u \leq 5.5 \\ 1, & 6 \leq u \leq 7 \\ \frac{u-5}{6-5} = \frac{u-5}{1}, & 5 \leq u \leq 6 \\ 6-5 = 1 \end{cases}$	<p>Minimum:</p> $\begin{cases} 0, & u \leq 0 \\ D^3D \pm D^3/4 u \geq 100 \\ 1, & 0 \leq u \leq 70 \\ \frac{100-u}{100-70} = \frac{100-u}{30}, & 70 \leq u \leq 100 \\ 0, & u \leq 85 \\ D^3D \pm D^3/4 u \geq 175 \\ \frac{u-85}{130-85} = \frac{u-85}{45}, & 85 \leq u \leq 130 \\ \frac{175-u}{175-130} = \frac{175-u}{45}, & 130 \leq u \leq 175 \\ 1, & 190 \leq u \leq 210 \\ \frac{u-160}{190-160} = \frac{u-160}{30}, & 160 \leq u \leq 190 \\ 190-160 = 30 \end{cases}$	<p>Minimum:</p> $\begin{cases} 0, & u \leq 0 \\ D^3D \pm D^3/4 u \geq 100 \\ 1, & 0 \leq u \leq 70 \\ \frac{100-u}{100-70} = \frac{100-u}{30}, & 70 \leq u \leq 100 \\ 0, & u \leq 85 \\ D^3D \pm D^3/4 u \geq 175 \\ \frac{u-85}{130-85} = \frac{u-85}{45}, & 85 \leq u \leq 130 \\ \frac{175-u}{175-130} = \frac{175-u}{45}, & 130 \leq u \leq 175 \\ 1, & 190 \leq u \leq 210 \\ \frac{u-160}{190-160} = \frac{u-160}{30}, & 160 \leq u \leq 190 \\ 190-160 = 30 \end{cases}$	

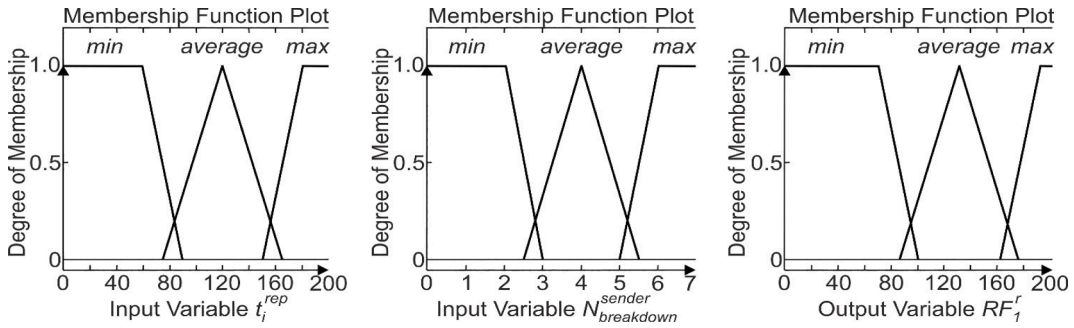
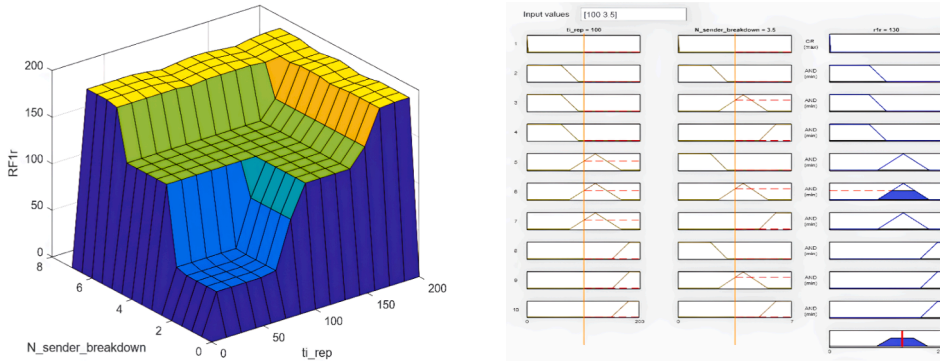

Fig. 10. Example of fuzzification of selected risk factors related to SC1.



a) Visualization of the logical-linguistic model fuzzy inference  $RF_1^r$  – Risk factor associated with the grain loader breakdown  
 b) The rules by which the logical-linguistic model works  $RF_1^r$  – risk factor associated with the grain loader breakdown

Fig. 11. Visualization of the Fuzzy Inference Based on the Simulation Results in the Matlab Environment. a) Visualization of the logical-linguistic model fuzzy inference  $RF_1^r$  – Risk factor associated with the grain loader breakdown. b) The rules by which the logical-linguistic model works  $RF_1^r$  – risk factor associated with the grain loader breakdown.

MFs for the other parameters are presented in Appendix C. Inequality systems can be graphically interpreted to visualize the intersection points between the fuzzy set of minimum and average values, and the intersection points between the average and maximum values of the corresponding fuzzy value. This is depicted in the Fig. 10 for a clearer understanding of this concept. In subsequent modelling, the established intersection points are refined using Matlab’s built-in functionality setting a fuzzy model, thereby increasing its adequacy for the process under study.

3.3. Mamdani-type model fuzzy inference

After the fuzzification procedure for each of the parameters, a logical-linguistic model is created based on a Mamdani-type model using fuzzy logic (Izquierdo & Izquierdo, 2018; Lambat et al., 2021; Harliana & Rahim, 2017). Mamdani-type models enable the

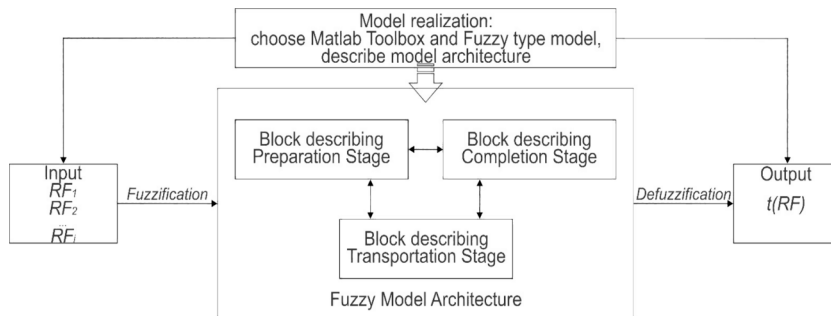

Fig. 12. Fuzzy Model Architecture with the MATLAB Toolbox.

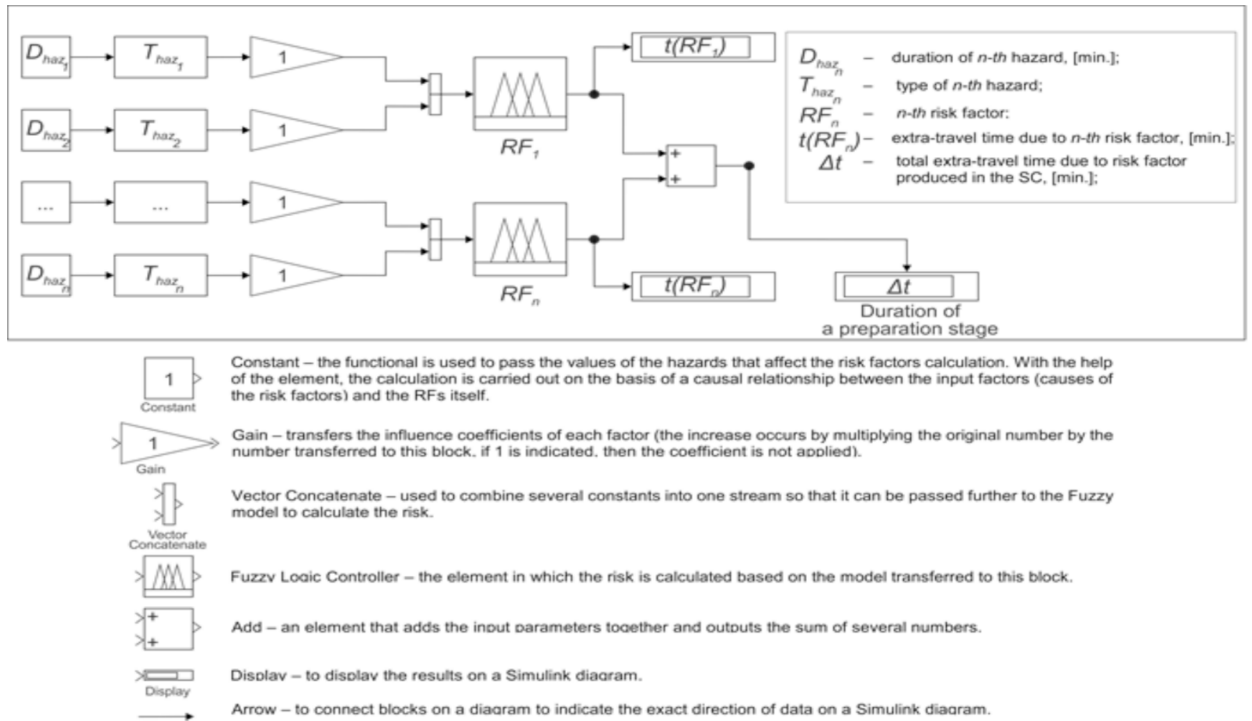

Fig. 13. Describing the Stages for SC Using Simulink.

definition of rules to link risk factors and allow reasoning about the system with a fuzzy set. Mamdani is particularly useful and intuitive when it comes to developing rules and models based on expert knowledge, which is the case here (MathWorks, 2023).

The view of the general logical-linguistic model for determining time delivery (SupplyChain1), which combines 11 fuzzy logical-linguistic models, will take the following general form:

$$T_{delivery}(R_{SupplyChain}) \Rightarrow \left\{ \begin{array}{l} \text{IF } RF_1^r(\text{minimal, medium, maximum}) \text{ AND } RF_2^r(\text{minimal, medium, maximum}) \\ \text{THEN } \sum_{RF=1}^2 RF_i \\ \text{IF } RF_4^r(\text{minimal, medium, maximum}) \text{ AND } RF_5^r(\text{minimal, medium, maximum}) \text{ AND} \\ RF_6^r(\text{minimal, medium, maximum}) \text{ AND } RF_7^r(\text{minimal, medium, maximum}) \text{ AND} \\ RF_8^r(\text{minimal, medium, maximum}) \text{ AND } RF_9^r(\text{minimal, medium, maximum}) \text{ AND} \\ RF_{10}^r(\text{minimal, medium, maximum}) \text{ THEN } \sum_{RF=1}^7 RF_i \\ \text{IF } RF_1^m(\text{minimal, medium, maximum}) \text{ AND } RF_2^m(\text{minimal, medium, maximum}) \\ \text{THEN } \sum_{RF=1}^2 RF_m \end{array} \right. \quad (5)$$

The elaboration of the fuzzy logico-linguistic models for other supply chains uses a similar description, as shown in Appendix D. According to equation (5), the final value of the reaction function is represented by the sum of the considered risk factors.

The changes in the fuzzy inference surface of the logical-linguistic model are shown in Fig. 11(a), where an increase in failures and repair time increases the value of RFR1. This means that the repair time is constant for a given number of failures. These plots can be used to refine the degree of influence of the causes on the risk factor and identify the causes that have the greatest influence on the risk. In the example shown, the probability of many failures should be reduced in order to lower the risk value. This is achieved through timely maintenance and regular control inspections of the fleet of loading mechanisms.

Fig. 11(b) shows the governing rules, which are detailed in Appendix E, and the iterations conducted during the simulation based on the selected type of membership functions and the corresponding partitioning into terms. The rules are generated for each fuzzy model. For example, as mentioned above, SC1 includes 11 models. Each model contains two hazards that generate the risk factor. Since each hazard (incoming parameter) has three levels of variation, a full factor experiment  $3^2$  is conducted to cover the entire spectrum of possible events. Nine rules occur, the tenth rule in each model is a zero rule. It characterises the possibility that the given risk factor will



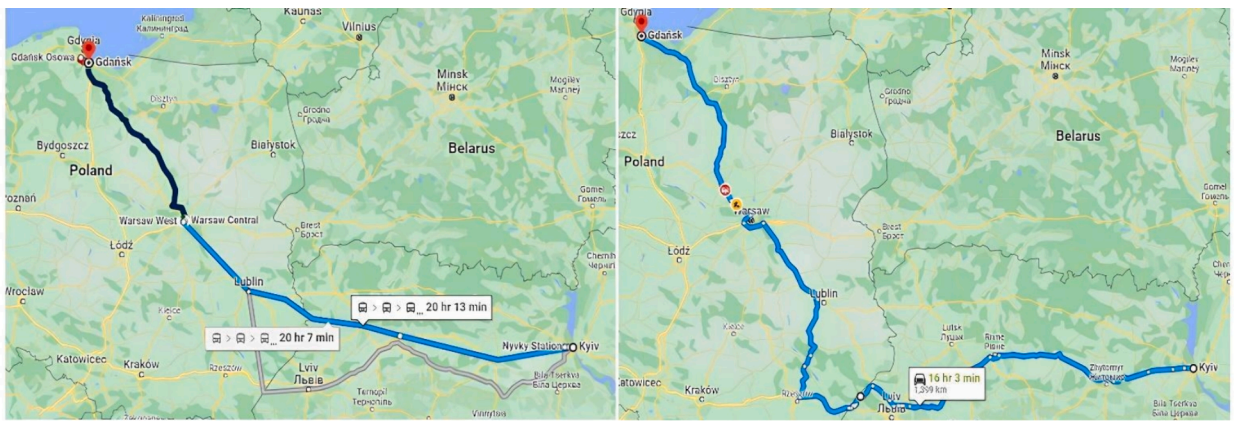

a) b)

Fig. 14. Railway (a) and Road (b) Route: Kyiv (Ukraine) – Gdansk (Poland).

not occur. There are therefore 10 rules for each model. SC1 therefore has 11 risk factor models, resulting in a total of 110 SC1 rules. The rules for SC2 and SC3, which are presented in Appendix E, have a similar structure. Based on the rules and fuzzy sets defined here, the risk model is then developed using the Simulink Fuzzy ToolBox (MathWorks,2023).

3.4. The model formation in Simulink

The main advantage of Simulink is a well-developed and intuitive unit for fuzzy modelling (Sezer et al., 2011). It has a built-in

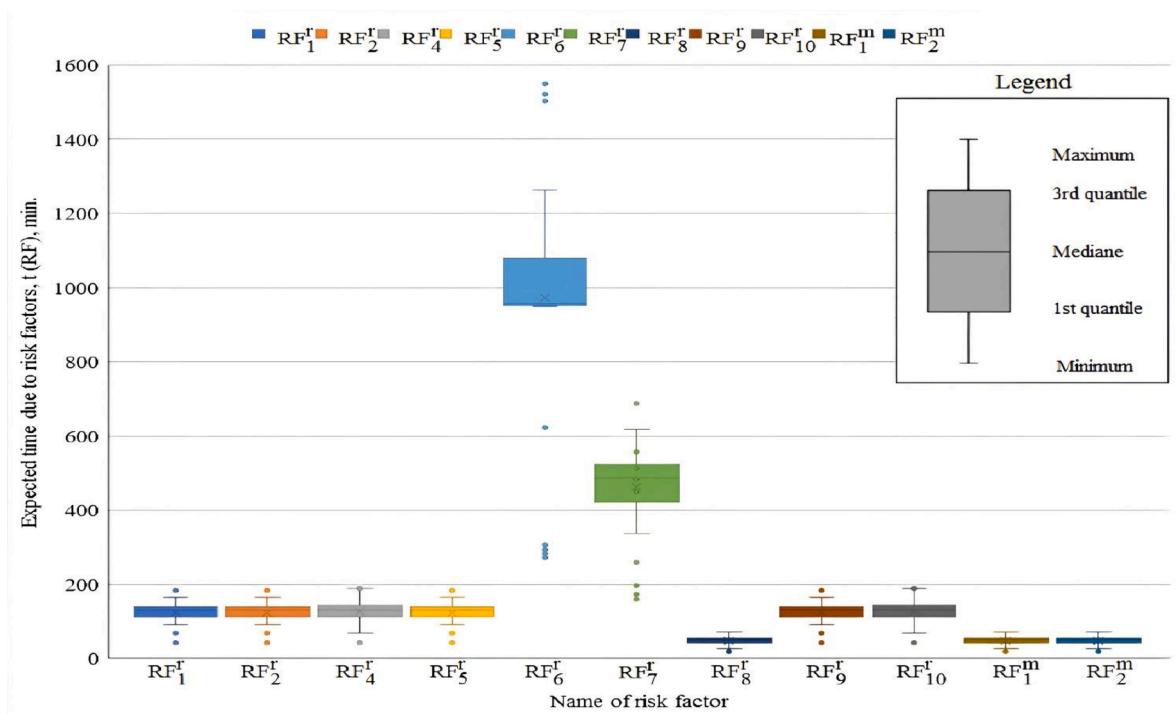

$RF_1^r$  – the breakdown of the grain loader at the dispatch point,  $RF_2^r$  – wagon downtime caused by errors in the planning of the interaction between the railway and the dispatch point and by external factors (accidents, unavailable routes);  $RF_4^r$  – due to delays in train formation at intermediate stations (country of origin);  $RF_5^r$  – due to disruptions during transportation,  $RF_7^r$  – due to customs procedures in multimodal transportation,  $RF_7^m$  – due to wheel set handling caused by the difference in gauge width in Ukraine and European countries,  $RF_8^r$  – due to delays at the transshipment point at the border,  $RF_8^m$  – breakdown of grain handling facilities;  $RF_{10}^r$  – due to delays in train formation at intermediate stations (country of destination);  $RF_1^m$  – takes into account operational unavailability of port facilities at the time of cargo arrival;  $RF_2^m$  intermittent cargo flow at the port

Fig. 15. Result of modelling the expected time due to the individual risk factors by a fuzzy model for SC1.

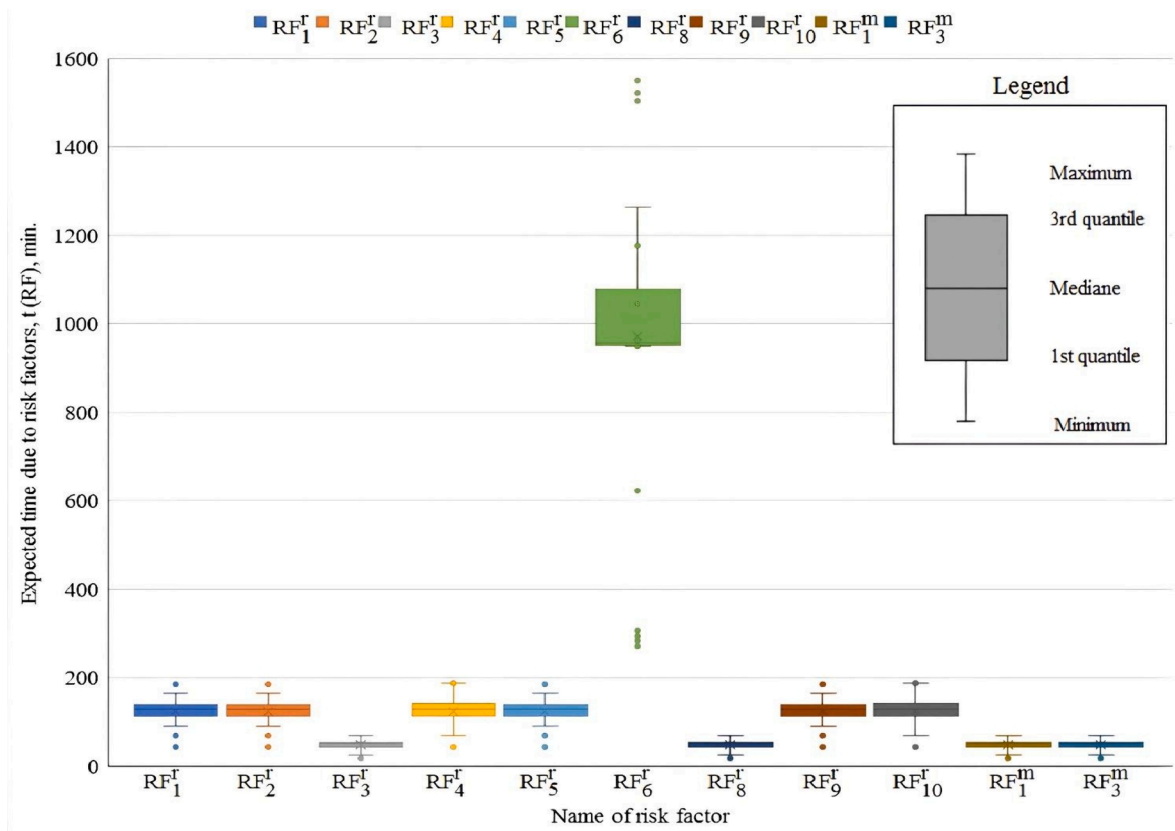

$RF_1^I$  – the breakdown of the grain loader at the dispatch point;  $RF_2^I$  – wagon downtime caused by errors in the planning of the interaction between the railway and the dispatch point and by external factors (accidents, unavailable routes);  $RF_3^I$  – due to failure in containers’ preparation for shipment in time;  $RF_4^I$  – due to delays in train formation at intermediate stations (country of origin);  $RF_5^I$  – due to disruptions during transportation;  $RF_6^I$  – due to customs procedures in multimodal transportation;  $RF_7^I$  – due to delays at the transshipment point at the border;  $RF_8^I$  – breakdown of grain handling facilities;  $RF_9^I$  – due to delays in train formation at intermediate stations (country of destination);  $RF_{10}^I$  – due to delays in train formation at intermediate stations (country of destination);  $RF_1^M$  – takes into account operational unavailability of port facilities at the time of cargo arrival;  $RF_2^M$  – due to failure of the port loader breakdown

Fig. 16. Result of modelling the expected time due to the individual risk factors by a fuzzy model for SC2.

algorithm for models such as Mamdani, Sugeno, etc., which can be quickly adapted to actual modelling decisions. In addition, the block structure allows the model to be unified and, if the analysed components of the supply chain change, the architecture can be quickly and easily adapted for a new model. This is also important when new hazards are identified and therefore new risk factors need to be included in the model.

The simplified functional architecture of the model developed using MATLAB Simulink is shown as a block diagram in Fig. 12.

### 3.4.1. The technical aspects of Simulink

The model used a block description of each stage. The model was divided into three large blocks. Each block included the following functional elements according to Simulink:

The presented diagrams (Fig. 13) allow an accurate reading of the information flow that passes through each element of the fuzzy logic model created in the Simulink environment to model the travel time based on risk factors and their hazards. To understand the simulation process, consider the simulation phases. The sequence of using Simulink can be illustrated as follows:

Preparing the model for launch: enter the initial data (hazards) for calculating the risk factors; start the risk calculation.

After this point the following takes place: the schematics takes constants that are filled with the initial data for calculating the risk factors; the constant then goes into the “Gain” block, which applies coefficients to the value; enter the “Vector Concatenate” block to combine multiple constants into a single vector; pass a single vector to the “Fuzzy Logic Controller” where the calculations take place according to the given Mamdani model; all risks are summarised using the “Add” block; the result is displayed on the screen using the “Display” block.

### 3.4.2. The generic architecture of the risk model in Simulink

For each SC, a fuzzy model is created in the Simulink environment in which the additional transport time caused by the expected risk factors is evaluated (Fig. 13). This value is then added to the undisturbed transport time, which is calculated based on the distance and average speed of the means of transport in a given SC. Finally, the risk model provides the expected transport time for each SC with

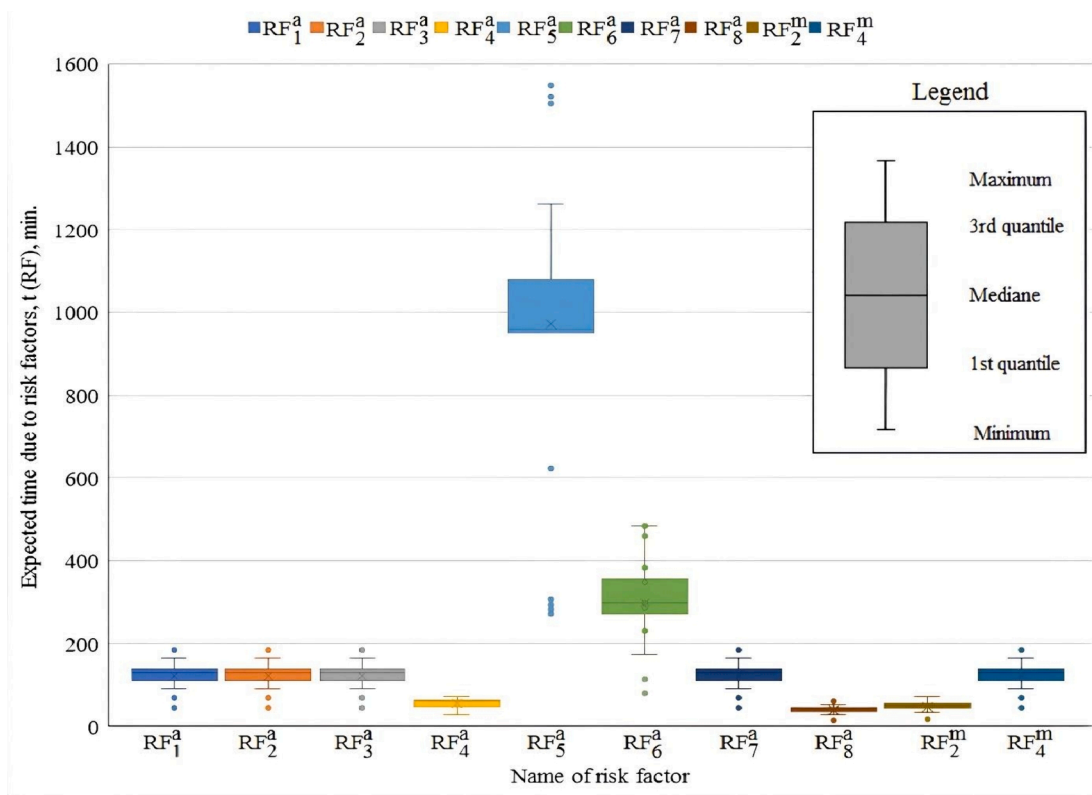

$RF_1^a$  – risk of the loader breakdown and  $RF_2^a$  – failure of coordination between cargo and vehicle dispatch point;  $RF_3^a$  – due to technical defects in the road transport stage;  $RF_4^a$  – deviations from the planned route,  $RF_5^a$  – due to delay caused by the custom clearance;  $RF_6^a$  – due to congestion at the border;  $RF_7^a$  – due to vehicle breakdowns and  $RF_8^a$  – due to vehicles with reduced speed on the  $i$ -th section of the route;  $RF_2^m$  – intermittent cargo flow at the port;  $RF_4^m$  – due to lorry congestion on arrival at the port

Fig. 17. Result of modelling the expected time due to the individual risk factors by a fuzzy model for SC3.

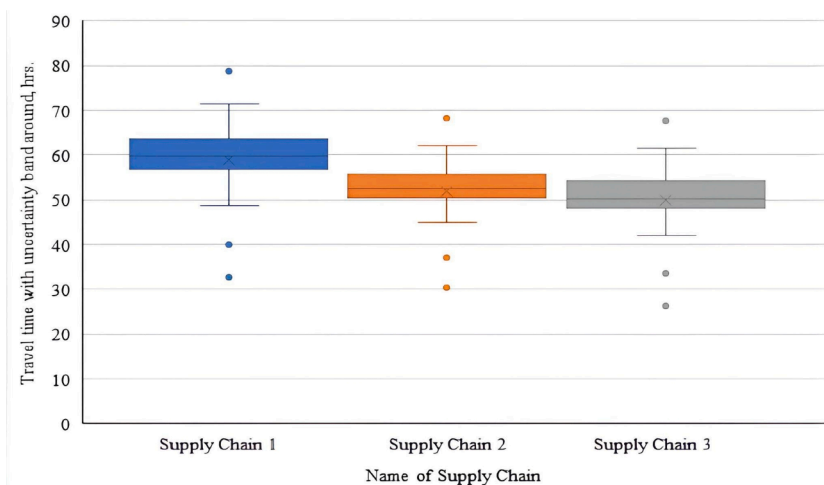

Fig. 18. Case study result of travel time for each SC with uncertainty band around.

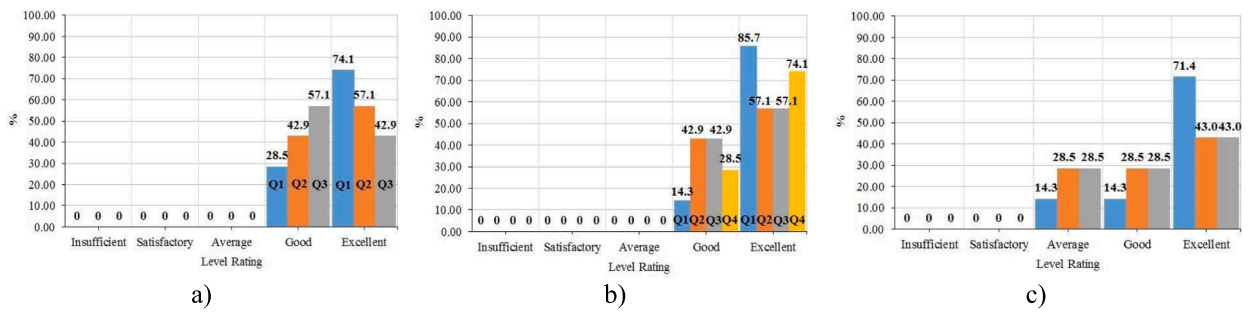

Fig. 19. Results of validation: a – Face Validation; b – Content Validation; c – Predictive Validation.

the uncertainty band due to the expected risk factors. The applicability and validity of the model is demonstrated by a case study presented in the next section.

## 4. Results and validation

### 4.1. Case-Study

The model presented above is then applied to a case study that describes the expected risk along the supply chain for agricultural products between the origin in Ukraine and the destination in Poland (Pavlenko et al., 2023b). This supply chain can be considered safety-critical, especially in the event of an unprovoked invasion of Ukraine and the disruption of existing overseas transport corridors through the Black Sea (Picheta et al., 2023). The supply chain follows one of the critical transport corridors for agricultural products in Central Eastern Europe, as shown in Fig. 14a and labelled as the Polish-Baltic route.

The routes along which the supply chain is located are shown in detail in Fig. 14b, where the left side shows a route along the railway, while the right side shows the route along the road.

Both are labelled with an uninterrupted travel time, without considering the duration of loading and unloading operations, customs clearance, technical breaks or other types of delays due to breakdowns or congestions. To account for the risk factors and their expected variability along the supply chains, the risk factors need to be stratified based on the interviews and publicly available information (Pavlenko et al., 2020).

Characteristics of routes on which the fuzzy model is tested:

1) The transportation of grain by railway hopper waggons follows the route from Kyiv to Yagodin, which is a border crossing, then continues to Lublin, Warsaw, and Gdansk. The total length of this route is 1266.7 km. In Ukraine, the average standard speed is 30 km/hour, and the railway gauge width is 1520 mm. After crossing the border, the railway gauge width changes to 1435 mm, and the average standard speed in Poland is 120 km/h. The hoppers used for this transportation have cargo capacities of 23.5 t (120 m<sup>3</sup>) and 24 t (103 m<sup>3</sup>).

2) Transportation using 20TEU containers or flexi tanks, which have a capacity of 24–25 tonnes (10,000–25,000 L). At the Yagodin border crossing, it takes up to 1 h per container to reload the railway containers at the terminal. Apart from this, all other aspects of transportation remain the same as in the first route 3. Grain road trains are used for transportation along the route Kyiv-Rava-Ruska (border crossing) – Gdansk with a total length of 1399 km. The speed limit in Ukraine is 55 km/h, while in Poland it is 78–80 km/h. These road trains use grain carriers with a cargo capacity ranging from 21.5 to 23.5 tons.

There are two modes of operation for drivers on the last route. If there is only one driver, they can cover a distance of 550–600 km per day, considering traffic on the highways. On the other hand, if there are two drivers, they can operate continuously for 21 h and cover an average distance of 900–1000 km per day.

### 4.2. Results

The results of the model, in particular the expected time due to the individual risk factors analysed for each SC, are shown in Figs. 15–17, which include summary statistics (median, quantiles, minima and maxima). In the case of SC1, shown in Fig. 15, the time for customs clearance in multimodal transport (RF<sub>6</sub>) and the time for wheelset change (RF<sub>7</sub>) contribute the most to the total journey time.

In addition, several values of the above-mentioned RFs significantly exceed the minimum and maximum values, such as customs clearance and waiting time due to congestion at the border. For SC2, shown in Fig. 16, the risk factor due to customs procedures in multimodal transport (RF<sub>6</sub>) has the greatest influence on journey time. In contrast, for SC3, as shown in Fig. 17, the time for customs clearance (RF<sub>5</sub>) and the time for congestion at the border (RF<sub>6</sub>) contribute the most to the total journey time.

The modelling results reveal the risk factors that have a significant impact and those with a negligible level of influence. In SC1 (Fig. 15) RF<sub>8</sub><sup>m</sup> because of a small delay at failures in an overload on border and RF<sub>1</sub><sup>m</sup> due to operational unavailability of port facilities at the time of cargo arrival and RF<sub>2</sub><sup>m</sup> intermittent cargo flow at the port belong to such RFs. The last two risks of the factor are more related to the arrival schedule of ships at the port, which is accurately planned to reduce the vessel's maintenance time. Clearer planning

requirements in the port, as a transshipment hub, is needed to minimize the negative impact of  $RF_1^m$  and  $RF_2^m$  on the extra travel time in agribusiness supply chains.

In addition, the largest deviation in extra travel time is observed by the following risk factors: time for customs clearance in multimodal transport ( $RF_6^t$ ) and the time for bogies change ( $RF_7^t$ ). The time increase due to  $RF_6^t$  ranges from 240 min to almost 1600 min per railway wagon. This spread is explained by significant problems arising from railway wagon customs clearance. A minor range of values is observed due to wheelset changing,  $RF_7^t$ . The severe deviations outside the 1.5 quartile for this RF are due to team qualification engaged in resolving this task at the border. Risk factors arising during shipment and transportation in the origin country, as well as transportation in the destination country, have an average impact level and are predictable. This is due to the high requirements for traffic safety and significant level of control that railway transport is subjected to.

A similar trend is observed when time for customs clearance in multimodal transportation ( $RF_6^t$ ) in SC2 (Fig. 16) is considered. For  $RF_6^t$ , the travel time deviation arises in the range of (260; 1540) minutes, which falls on customs clearance per container. During 30 modelling tests, four values  $RF_6^t$  exceeded 1.5 quartiles and approached the minimum value within the above range. Additionally, three values caused the maximum extra travel time. Minimal and approximately equal exposure is fixed against risk factors  $RF_3^s$ ,  $RF_8^s$ ,  $RF_1^m$  and  $RF_3^m$ .

Analysis of the results of SC3 modelling (Fig. 17) highlights the risk factors of  $RF_5^a$  and  $RF_6^a$  at customs from a negative aspect. In addition to the fact that these two risk factors cause the greatest increase in travel time, they are still characterized by a deviation for several values from 1.5 quartiles, which determines the main impact boundaries due to these risk factors. This confirms the fuzzy nature and complexity of predicting risks at the border. Therefore, hazards arising at the border should be considered as the main ones in supply chain planning. The slight increase in travel time is due to possible route deviations on  $RF_4^a$ . This means that any changes in the planned route will not significantly increase the travel time, as the road networks in European countries are extensive. However, slowing down at a particular location on the route ( $RF_8^a$ ) may cause a slight delay in travel time. It is explained by the fact that the speed limit is almost constant since the routes mainly pass through the highways, with no congestions.

For each SC, the standard deviation is estimated by performing 30 simulation runs in which the input values (RFs) are varied in the range defined by their minimum and maximum values. In this way, it is possible to check the tendency of the model and identify its unusual behaviour. The resulting travel time for the analysed SCs considering all RFs is shown in Fig. 18.

For SC1 it ranges from 49 to 71 h, for SC2 from 45 to 62 h, while for SC3 it is 42 to 62 h. The figure also shows outliers in the journey time values beyond the 1.5 quartiles.

#### 4.3. Validation

The result of the face validity is shown graphically in Fig. 19a and allows reaching the following conclusions:

1) The structure of the model corresponds to the number of blocks, the input parameters and the applied fuzzy algorithm described in the literature and expert knowledge.

2) Each input parameter of the model reflects the expert opinion.

3) The risk factors entered into the model correspond to the experts' suggestions regarding specific hazards in SC.

The results of the content validation are shown in Fig. 19b and allow reaching the following conclusions:

1) The output of the model is relevant to the RFs entered, which match the expert opinions.

2) All ranges of the input RFs fulfil their possible values.

3) The application of Mamdani's algorithm is appropriate to reflect the initial relationship between output and input values.

4) The input values of the parameters reflect the results of the expert survey.

In the predictive validity phase, some experts found it difficult to evaluate all the questions asked in validation section 2.5.3. This can be seen in Fig. 19c, where about 30 % of respondents answered "Average", which shows that it is difficult for drivers to evaluate a fuzzy model in relation to a predictor. The model is suitable for predicting extreme system behaviour as the estimated travel time increases proportionally to the input parameters as expected. In case of new hazards, the model can be easily extended.

According to the results of the concurrent validity test, the following answers were given to the corresponding questions:

1) The fuzzy model contains the same parameters as the linear formulas when calculating the risk factors.

2) The results of the fuzzy modelling are obtained in the same dimensional units as in the deterministic approach.

3) The quality of the fuzzy model calculations can be compared with the results of the linear formulae by determining statistical errors.

The answer to the last question is described in detail in the discussion below.

## 5. Discussion

The presented fuzzy model is characterised by a sufficient ability to calculate the predicted value of the delivery time if the degree of discretisation of the risk factors, which are discrete variables, is taken into account. In the study, the discretisation of the variables is presented in the form of an iterative heuristic process for selecting values with equal distance between the extremes, i.e. the minimum and maximum values of the range of variation determined by experts. At the same time, the discrete values are also technical and operational parameters that determine the value of the risk factors as components. A uniform degree of discretisation (time step) avoids possible "jumps" during modelling in the event of a change in the extent of the impact of a particular risk factor (its components) on the delivery time along the corresponding supply chain. This may be due to changes in the transport route caused by newly emerging situations that may change the structure of the previously defined hazards reflecting a particular risk factor. Therefore, one

should be aware that a change in the level of discretisation may lead to a change in the predictive power of the fuzzy model, even if its structure remains unchanged.

The presented model takes into account a considerable range of operational and technical hazards that occur in the grain supply chain. Therefore, the results obtained in terms of delivery time objectively reflect the possible failures and the negative impact of the risk on the extension of the delivery time along the considered routes.

The most important results of this study:

1) The expert survey allowed a high-quality identification of the main technical and operational hazards causing increased travelling time, based on a risk assessment in a proactive way. The analysis showed that the biggest problems occur when crossing borders. Road and rail transport face challenges due to insufficient bandwidth at the checkpoints to handle a large number of lorries or due to the different lane widths for rail transport.

2) The developed fuzzy model calculates the travel time along the rail and automotive supply chain. The results justify the selection of a third technology (Grain Transportation by Bulk Grain Trucks and Road Trains) due to the current level of technical and operational risks in the grain supply chain. This technology has fewer negative impacts and risks because there is no reloading process in customs (SC3). On the other hand, SC2 appears to be more promising when it comes to reloading containers at a customs terminal, compared to the disruptions that can occur when changing wheelsets in the first system (SC1) or the failures that can happen when transporting the same amount of cargo across the border by road (SC3). This is especially true due to congestions caused by embargoes and human factors.

3) The model uses fuzzy logic to reduce the uncertainty of the risk that affects the response function, such as extra travel time. Fuzzy logic is a recognized and useful tool for assessing risks, particularly for newly established and essential supply chains. This increases the accuracy of the result, as confirmed by comparing the error values with the deterministic approach and the initial setting of the fuzzy model.

The model can be further developed to capture a broader range of hazards related not only to the operational aspect of the supply chain, but also to organisational aspects and a wider range of transported goods and the specific hazards associated with them. In addition, the model can be adapted to analyse other supply chains, such as piggyback transport, and to refine the hazard set.

### 5.1. Discussion on cross-validation

The results of the validation analyses indicate that the fuzzy model designed in the study has a good degree of conformity with the original data. These results also allow an assessment of the impact of operational and technical risk factors on the change in delivery time of agricultural products on international routes. The study presented in this paper confirms the accuracy of the fuzzy model results through concurrent validity. Therefore, different types of errors were evaluated and compared with the deterministic approach (Appendix F) to determine their values.

According to the first criterion of face validation, described in Method for face validity, section 2.5.3.1, the fuzzy model fully complies with the specified requirements. Under the second condition, the fuzzy model provides a clear risk result for the time deviation through defuzzification. It can therefore be argued that the developed model is suitable for the solution of the task.

### 5.2. Discussion on feasibility of the fuzzy model

Table E.1 (Appendix F) shows that the results of the fuzzy model correlate strongly with the deterministic approach. This justifies the high quality of the calculations with the fuzzy model, which is burdened with small errors only. The values determined with the fuzzy model for the travel time with  $t(RFs)$  therefore have a high accuracy. Accordingly, the fuzzy model can be successfully used for planning the grain supply chain considering technical and operational hazards.

### 5.3. Discussion on the model limitations

The limitations of the model in its application can be enumerated as follows:

1) The result obtained by the model can be used within the specified ranges that linguistic variables assume for the parameters that cause a particular risk factor. If new values that fall outside the ranges are entered, the model should be reconfigured and the results verified using a test experiment.

2) If the grain delivery technology is changed, the risk factors need to be restructured and consequently aggregated. This is due to the probability of a new type of risk situation. Therefore, an additional sample of operational and technical risk factors is created.

3) The model only considers technical and operational aspects, so that hazards of a political, economic, environmental and other nature are not taken into account, however these could be considered in the future.

4) The accuracy of the results obtained with the fuzzy model is only validated by comparison with the deterministic approach (formulae), as the possibility of comparison with real routes is no longer given due to military restrictions.

5) The model was not tested on piggyback transportation as it is not currently used for agri-food products in the case study.

Thus, the defined boundary of the model determines its scope of application. However, the proposed method is generic and can be easily adapted if the range of input parameters changes.

#### 5.4. Discussion on the distinguishing factors from the fuzzy implementation point of view per each SC

Despite the generic nature of the fuzzy model approach, there are differences in its implementation for each supply chain. The distinguishing factors for each supply chain in terms of fuzzy realization are as follows:

1) Experts help identify a unique set of hazards for every supply chain that represents the relevant risk factors. This results in a distinct set of membership functions, which are adjusted on the basis of specific threats within the supply chain. The authors are referring to the linguistic variable values for a fuzzy model, which ascertain the alteration in each risk factor within the defined range. These adjustments are determined using formulas based on expert knowledge.

2) Every supply chain has its own fuzzy model. The fuzzy model for SC1 (Transportation of Grain by Railway with Grain Wagons) consists of 11 blocks, similarly, the fuzzy model for SC2 (Transportation of Grain by Rail in Containers on Flat Wagons) also consists of 11 blocks. Additionally, the fuzzy model for SC3 (Grain Transportation by Bulk Grain Trucks and Road Trains) contains 10 blocks. Each block is based on the fuzzification of a specific risk factor caused by corresponding hazards to the considered supply chain.

3) Each of the fuzzy models developed in the study is designed to address the challenges of a specific supply chain. This is because the risks vary depending on the mode of delivery, and this is reflected in the membership functions. If, for example, one of the three supply chains (SC3 – road transport) is not utilized, the other two fuzzy models can estimate the extra travel time based on the risks associated with SC1 and SC2. These models are tailored to specific supply chains and provide accurate assessments.

4) For each supply chain, a separate fuzzy inference formula is mathematically formalized according to the Mamdani method. Formula 5 represents SC1, while SC2 and SC3 are presented in [Appendix D](#).

The generic principle of designing fuzzy models for each supply chain demonstrates the adaptability of the approach. This means that when initiating a new supply chain, such as piggybacking, a new model can be quickly redeveloped based on the additional hazards identified by the new supply chain. This will also entail some adjustments to the process of data fuzzification for a fuzzy model.

#### 5.5. Discussion of the proposed fuzzy model comparability with other approaches

During the literature review, the authors highlighted the impossibility of using existing methods based on fuzzy logic in the context of the proposed specifics of assessing risk factors in supply chains. As a result, there are no prerequisites to compare previous studies and their results with the proposed approach in classic understanding. The comparability of the authors' model with others can be shown due to the following points:

- 1) Inclusion in the system of risk assessment by operational or technical hazards in a generic view;
- 2) Conducting an expert survey to identify risks in the supply chain;
- 3) Using triangular or trapezoidal membership functions for a fuzzy model;
- 4) The model or decision-making system validation by experts;
- 5) Checking different errors, typically based on the Mean Absolute Error (MAE).

The developed fuzzy model's primary comparability points with existing approaches allow identifying areas of future research and expanding the model's capabilities.

Although there are some similarities, the fuzzy model's results cannot be compared to those of other models because they have different evaluation principles. The main feature of the proposed model consists not only in identifying risks but also in identifying the causes of threats and establishing their pattern of influence on the response function. Therefore, the comparison was made with a deterministic approach, and the results validated the accuracy of the initial fuzzy model configuration. ([Section 5.1](#) and [Appendix F](#)).

## 6. Conclusion

This study introduces a new direction in the assessment of risk using fuzzy logic in critical supply chains that has not been previously discussed in the literature. The objective of this work is to create a fuzzy logic-based model for determining grain delivery time that takes into account technical and operational risk factors. Ultimately, the fuzzy model enables the operational calculation of travel times for different grain supply chain options, taking into account several risk groups that influence the sustainability rate of supply chains.

The proposed fuzzy model was developed using the Fuzzy Toolbox in MATLAB, and its block elements were merged into a single module in Simulink. The model was validated in four aspects: Face, Content, Predictive and Concurrent Validation. The last validation was tested using the estimated error values between the proposed fuzzy model and a similar deterministic approach. It confirmed the high quality of the results obtained and justified the use of a fuzzy model for the design of the grain supply chain taking risk factors into account.

Subsequently, the model was applied in several case studies reflecting existing grain supply chains between Ukraine and Poland. According to the results obtained, the average transport time for grain, taking into account technical and operational risks, was: SC1-59 h, SC2-52 h and SC3-50 h. The highest risk impact was found for SC1 and amounted to 10.3 %. This percentage means that the initial travel time (excluding RFs) increases and the duration increases due to the negative impact of the risk factors. Based on the main findings, the following policy implications can be drawn.

1. Agrobusiness managers can choose the fastest route with less impact on the duration of key operational and technical risks and utilise them efficiently.
2. Before crossing the border with a lorry, it is necessary to check the queue at the checkpoint and, if necessary, choose a less congested route to avoid delays.

3. In order to increase freight traffic, the possibility of expanding transshipment terminals by rail or building an additional railway line with the possibility of using mobile transshipment vessels can be considered.

4. Consideration of the introduction of a piggyback train for the transport of agricultural food products between Kyiv and Gdansk at the interstate level between Ukraine and Poland.

5. The last recommendation is quite profitable as it reduces the risks of transshipment and shortens the total travelling time compared to the third supply chain.

Future research includes the development of a predictive risk model based on an evolutionary mechanism that allows flexibility and rapid decision making in the planning of new grain supply chains. A recommendation for the further development of the proposed fuzzy model is to expand its scope of application. This can be done by testing it on other supply chains to identify particular risks that could be unique to a particular technology or route.

#### Author's Contributions

Conceptualization, Ievgen Medvediev (IM), Dmitriy Muzylyov (DM); methodology: DM, IM; software: IM; formal analysis: DM, IM, Jakub Montewka (JM); investigation: DM, IM; resources: IM, JM; data curation: DM, IM; creation of the initial draft: DM, IM; writing-review and editing: JM; visualization: DM, IM; supervision: JM; project administration: JM, IM; fundraising: IM, JM. All authors have read and agreed to the published version of the manuscript.

#### CRedit authorship contribution statement

**Ievgen Medvediev:** Writing – original draft, Visualization, Software, Resources, Project administration, Methodology, Investigation, Funding acquisition, Formal analysis, Data curation, Conceptualization. **Dmitriy Muzylyov:** Writing – original draft, Visualization, Validation, Methodology, Investigation, Formal analysis, Data curation, Conceptualization. **Jakub Montewka:** Writing – review & editing, Supervision, Resources, Project administration, Funding acquisition, Formal analysis.

#### Declaration of competing interest

The authors declare that they have no known competing financial interests or personal relationships that could have appeared to influence the work reported in this paper.

#### Data availability

Data will be made available on request.

#### Acknowledgments

This research was supported by the Horizon Europe Marie Skłodowska-Curie Actions under MSCA4Ukraine funding scheme (project number 1233438, “Systemic, risk-informed decision support system for the definition of boundary conditions for safe inland navigation based on a novel logico-linguistic model”).

The authors wish to acknowledge the following: provision of expert consultation and practical advice in freight transportation on the route Ukraine-Poland **Serhii Burynda**, international truck driver from Company ELT Easy Logistic with Nielsen and Sorensen group, Poland; informational support, recommendations and assistance in setting up Fuzzy Logic Designer and Simulink Project Schema **Yehor Baklanov**, Senior Software Engineer, Self-employed, Master’s degree in Information Systems of Volodymyr Dahl East Ukrainian National University, Kyiv, Ukraine and **Oleksandr Pindyk**, Engineering Lead, Senior Software Engineer at Wargaming, Kyiv, Ukraine; for expert consultations in fuzzy models applied in complex technical and technological systems **Peter Eliseyev**, PhD, Department of Computer-Integrated Control Systems, Volodymyr Dahl East Ukrainian National University and **Serhiy Shtovba**, Professor, Department of Information Technologies, Vasyl’ Stus Donetsk National University, Vinnytsia, Ukraine; assistance in translation and text revision **Elena Smirnova**, PhD, Volodymyr Dahl East Ukrainian National University, Ukraine and **Maciej Zaremba**, project specialist, Gdansk University of Technology, Gdansk, Poland.

#### Appendix A. Supplementary material

Supplementary data to this article can be found online at <https://doi.org/10.1016/j.tre.2024.103691>.

#### References

- Anufriyeva, T., Matsiuk, V., Shramenko, N., Ilchenko, N., Pryimuk, O., Lebid, V., 2023. Construction of a simulation model for the transportation of perishable goods along variable routes. *Eastern-European J. Enterprise Technol.* 2 (4(122)), 42–51. <https://doi.org/10.15587/1729-4061.2023.277948>.
- Aqlan, F., Lam, S.S., 2015. A fuzzy-based integrated framework for supply chain risk assessment. *Int. J. Prod. Econ.* 161, 54–63. <https://doi.org/10.1016/j.ijpe.2014.11.013>.
- Arcese, G., Fortuna, F., Pasca, M.G., 2023. The sustainability assessments of the supply chain of agri-food products: the integration of socio-economic metrics. *Curr. Opin. Green Sustain. Chem.* 40, 100782 <https://doi.org/10.1016/j.cogsc.2023.100782>.





- Avelar-Sosa, L., García-Alcaraz, J.L., Castellón-Torres, J.P., 2014. The effects of some risk factors in the supply chains performance: a case of study. *J. Appl. Res. Technol.* 12 (5), 958–968. [https://doi.org/10.1016/S1665-6423\(14\)70602-9](https://doi.org/10.1016/S1665-6423(14)70602-9).
- Aven, T., 2012. The risk concept – historical and recent development trends. *Reliab. Eng. Syst. Saf.* 99, 33–44. <https://doi.org/10.1016/j.res.2011.11.006>.
- Barua, A., Mudunuri, L.S., Kosheleva, O., 2014. Why trapezoidal and triangular membership functions work so well: towards a theoretical explanation. *J. Uncertain Syst.* 8 (3), 164–168.
- Bede, B., 2013. Fuzzy Sets. In: *Mathematics of Fuzzy Sets and Fuzzy Logic*, Springer, Berlin, Heidelberg, 295, pp. 1–12. [https://doi.org/10.1007/978-3-642-35221-8\\_1](https://doi.org/10.1007/978-3-642-35221-8_1).
- Behret, H., Öztaysi, B., Kahraman, C., 2011. A Fuzzy Inference System for Supply Chain Risk Management. In: Wang, Y., Li, T. (Eds.), *Practical Applications of Intelligent Systems. Advances in Intelligent and Soft Computing*, Springer, Berlin, Heidelberg, 124, pp. 429–438. [https://doi.org/10.1007/978-3-642-25658-5\\_52](https://doi.org/10.1007/978-3-642-25658-5_52).
- Bespalov, A., Wicke, K., Castagné, V., 2019. Blinding and Randomization. In: Bespalov, A., Michel, M., Steckler, T. (Eds.) *Good Research Practice in Non-Clinical Pharmacology and Biomedicine*, Springer, Cham, 257, pp. 81–100. [https://doi.org/10.1007/978-3-319-92799-9\\_279](https://doi.org/10.1007/978-3-319-92799-9_279).
- Chin, Y., Seow, H., Lee, L., Rajkumar, R., 2018. Fuzzy mathematical model for solving supply chain problem. *J. Comput. Commun.* 6, 73–105. <https://doi.org/10.4236/jcc.2018.69007>.
- Choi, T., 2020. Risk analysis in logistics systems: a research agenda during and after the COVID-19 pandemic. *Transport. Res. Part E: Logist. Transport. Rev.* 145, 102190. <https://doi.org/10.1016/j.tre.2020.102190>.
- Choudhary, D., Kumar, A., Huo, B., 2023b. Examination of sustainability risk in freight shipping based on the theory of planned behavior with temporal analysis. *Transport. Res. Part E: Logist. Transport. Rev.* 176, 103191. <https://doi.org/10.1016/j.tre.2023.103191>.
- Choudhary, N.A., Singh, S., Schoenherr, T., Ramkumar, M., 2023a. Risk assessment in supply chains: a state-of-the-art review of methodologies and their applications. *Ann. Oper. Res.* 322, 565–607. <https://doi.org/10.1007/s10479-022-04700-9>.
- Cintula, P., Fermüller, C. G., Noguera, C., 2021. Fuzzy Logic. The Stanford Encyclopedia of Philosophy. [online] Available at: <<https://plato.stanford.edu/archives/sum2023/entries/logic-fuzzy/>>. [Accessed 25 March 2023].
- Darkes, J., Greenbaum, P.E., Goldman, M.S., 1998. Sensation seeking-disinhibition and alcohol use: exploring issues of criterion contamination. *Psychol. Assess.* 10 (1), 71–76. <https://doi.org/10.1037/1040-3590.10.1.71>.
- Denys O. V., 2021. Increasing the efficiency of cargo delivery in international piggyback transportation. Scientific qualification work manuscript copyright. PhD Thesis. National Transport University of the Ministry of Education and Science of Ukraine, Kyiv.
- Díaz-Curbelo, A., Gento, A.M., Redondo, A., Aqlan, F., 2019. A fuzzy-based holistic approach for supply chain risk assessment and aggregation considering risk interdependencies. *Appl. Sci.* 9 (24), 5329. <https://doi.org/10.3390/app9245329>.
- Digging. In: *Risks and Challenges Around Grain Transportation*, n. d. [podcast] Available at: <<https://alliant.com/news-resources/podcast-risks-and-challenges-around-grain-transportation/>> [Accessed 20 Sept. 2023].
- DSTU IEC/ISO 31010:2013 Risk management. Methods of general risk assessment (62225). State normative acts on labor protection website. [online] Available at: [https://dnaop.com/html/62225/doc-%D0%94%D0%A1%D0%A2%D0%A3%IEC\\_ISO\\_31010\\_2013](https://dnaop.com/html/62225/doc-%D0%94%D0%A1%D0%A2%D0%A3%IEC_ISO_31010_2013) [Accessed 19 February 2024].
- Dubinín, E.F., Kuksova, V.I., 2019. Methods and models of fuzzy logic in the systems of technical diagnostics. *Procedia Struct. Integrity* 20, 103–107. <https://doi.org/10.1016/j.prostr.2019.12.123>.
- El Jaouhari, A., El Bhlát, E.M., Arif, J., 2023. Scrutinizing IoT applicability in green warehouse inventory management system based on Mamdani fuzzy inference system: a case study of an automotive semiconductor industrial firm. *J. Ind. Prod. Eng.* 40 (2), 87–101. <https://doi.org/10.1080/21681015.2022.2142303>.
- Eurostat. [online] Available at: <[https://ec.europa.eu/eurostat/statistics-explained/index.php?title=Main\\_Page](https://ec.europa.eu/eurostat/statistics-explained/index.php?title=Main_Page)> [Accessed 25 March 2023].
- Fan, D., Lin, Y., Fu, X. (M.), Yeung, A., Shi, X., 2023. Supply chain disruption recovery in the evolving crisis – Evidence from the early COVID-19 outbreak in China. *Transport. Res. Part E: Logist. Transport. Rev.* 176, 103202. <https://doi.org/10.1016/j.tre.2023.103202>.
- FAO, 2023. Ukraine: Impact of the war on agricultural enterprises – Findings of a nationwide survey of agricultural enterprises with land up to 250 hectares, January–February 2023. Rome. <https://doi.org/10.4060/cc5755en>.
- Fernandes, G., Teixeira, P., Santos, T.A., 2023. The impact of the Ukraine conflict in internal and external grain transport costs. *Transport. Res. Interdiscipl. Perspect.* 19, 100803. <https://doi.org/10.1016/j.trip.2023.100803>.
- Gerami Seresht, N., Lourenzutti, R., Fayek, A.R., 2020. A fuzzy clustering algorithm for developing predictive models in construction applications. *Appl. Soft Comput.* 96, 106679. <https://doi.org/10.1016/j.asoc.2020.106679>.
- Girdžiūtė, L., 2012. Risks in Agriculture and Opportunities of their Integrated Evaluation. *Procedia. Soc. Behav. Sci.* 62, 783–790. <https://doi.org/10.1016/j.sbspro.2012.09.132>.
- Golebiowski, P., Góra, I., Bolzhelarskiy, Y., 2023. Risk assessment in railway rolling stock planning. *Arch. Transport* 65 (1), 137–154. <https://doi.org/10.5604/01.3001.0016.2817>.
- Gupta, S., Biswas, P.K., Aljafari, B., Thanikanti, S.B., Das, S.K., 2023. Modelling, simulation and performance comparison of different membership functions based fuzzy logic control for an active magnetic bearing system. *J. Eng.* 2023, 1–20. <https://doi.org/10.1049/tje.2.12229>.
- Gurtu, A., Johny, J., 2021. Supply chain risk management: literature review. *Risks* 9 (1), 16. <https://doi.org/10.3390/risks9010016>.
- Harliana, P., Rahim, R., 2017. Comparative analysis of membership function on mamdani fuzzy inference system for decision making. *J. Phys. Conf. Ser.* 930, 012029. <https://doi.org/10.1088/1742-6596/930/1/012029>.
- Herasymentko, O., 2019. Risk-oriented approach to management: identification of risks of enterprise railway transport. *Cherkasy University Bulletin Economics Sciences* 2, 13–19. <https://doi.org/10.31651/2076-5843-2019-2-13-19>.
- Hooda, D.S., Raich, V., 2017. Fuzzy Logic Models and Fuzzy Control An Introduction, Alpha Science International Ltd., U.K., Oxford.
- International Standards Organisation, 2009. ISO GUIDE 73:2009 Risk management. Vocabulary. [online] Available at: <<https://www.iso.org/standard/44651.html>> [Accessed 12 January 2024].
- International Standards Organisation, 2018. ISO 31000:2018, Risk Management - Principles and Guidelines. Geneva: ISO. [online] Available at: <<https://www.iso.org/iso-31000-risk-management.html>> [Accessed 20 Sept. 2023].
- International Standards Organisation, 2020. ISO 31022 Risk Management-Guidelines for the Management of Legal Risk. Geneva: ISO. [online] Available at: <<https://www.iso.org/standard/69295.html>> [Accessed 19 February 2024].
- Izquierdo, S.S., Izquierdo, L.R., 2018. Mamdani fuzzy systems for modelling and simulation: a critical assessment. *J. Artif. Soc. Soc. Simul.* 21 (3), 2. <https://doi.org/10.18564/jasss.3660>.
- James, A., Choy, S.L., Mengersen, K., 2010. Elicitor: An expert elicitation tool for regression in ecology. *Environ. Model. Softw.* 25, 129–145.
- Janjua, N.K., Nawaz, F., Prior, D., 2023. A fuzzy supply chain risk assessment approach using real-time disruption event data from Twitter. *Enterprise Information Systems* 17 (4), 1959652. <https://doi.org/10.1080/17517575.2021.1959652>.
- Jankelova, N., Masar, D., Moricova, S., 2017. Risk factors in the agriculture sector. *Agric. Econ.* 63 (6), 247–258. <https://doi.org/10.17221/212/2016-AGRICECON>.
- Johnson, S., Fielding, F., Hamilton, G., Mengersen, K., 2010. An integrated bayesian network approach to Lyngbya majuscula bloom initiation. *Mar. Environ. Res.* 69 (1), 27–37. <https://doi.org/10.1016/j.marenvres.2009.07.004>.
- Kiyko, S., Druzhinin, E., Prokhorov, O., Ivanov, V., Haidabrus, B., Grabis, J., 2020. Logistics control of the resources flow in energysaving projects: Case study for metallurgical industry. *Acta Logistica* 7 (1), 49–60. <http://doi.org/10.22306/al.v7i1.159>.
- Koohathongsumrit, N., Chankham, W., 2023. Route selection in multimodal supply chains: a fuzzy risk assessment model-BWM-MARCOS framework. *Appl. Soft Comput.* 137, 110167. <https://doi.org/10.1016/j.asoc.2023.110167>.
- Koohathongsumrit, N., Meethom, W., 2021. An integrated approach of fuzzy risk assessment model and data envelopment analysis for route selection in multimodal transportation networks. *Expert Syst. Appl.* 171, 114342. <https://doi.org/10.1016/j.eswa.2020.114342>.
- Lambat, Y., Ayres, N., Maglaras, L., Ferrag, M.A., 2021. A mamdani type fuzzy inference system to calculate employee susceptibility to phishing attacks. *Appl. Sci.* 11 (19), 9083. <https://doi.org/10.3390/app11199083>.

- Kreinovich, V., Kosheleva, O., Shahbazova, S.N., 2020. Why Triangular and Trapezoid Membership Functions: A Simple Explanation. In: Shahbazova, S., Sugeno, M., Kacprzyk, J. (Eds.), *Recent Developments in Fuzzy Logic and Fuzzy Sets. Studies in Fuzziness and Soft Computing*, Springer, Cham, 391, pp. 25–31. [https://doi.org/10.1007/978-3-030-38893-5\\_2](https://doi.org/10.1007/978-3-030-38893-5_2).
- Lebid, I., Luzhanska, N., Lebid, Ie., 2022. Optimization of the Customs Clearance Process for Goods of Different Nomenclature. *Transport Means. Proceedings of the International Conference*, October 2022, pp. 61–67.
- Lebid, I., Luzhanska, N., Lebid, I., Mazurenko, A., Halona, I., Horban, A., Mykhailenko, I., Medvediev, I., Sotnikova, T., 2023. Construction of a simulation model of goods delivery in international road transportation taking into account the functioning efficiency of logistics supply chain. *Eastern-European J. Enterprise Technol.* 3 (3 (123)), 57–67. <https://doi.org/10.15587/1729-4061.2023.280886>.
- Li, J., Jing, K., Khimich, M., Shen, L., 2023. Optimization of green containerized grain supply chain transportation problem in Ukraine considering disruption scenarios. *Sustainability* 15 (9), 7620. <https://doi.org/10.3390/su15097620>.
- Liao, R., Liu, W., Yuan, Y., 2023. Resilience improvement and risk management of multimodal transport logistics in the Post-COVID-19 Era: the case of TIR-based sea-road multimodal transport logistics. *Sustainability* 15, 6041. <https://doi.org/10.3390/su15076041>.
- MathWorks, 2023. [online] Available at: < <https://www.mathworks.com> > [Accessed 20 Sept. 2023].
- McDougall, N., Wagner, B., MacBryde, J., 2022. Competitive benefits & incentivisation at internal, supply chain & societal level circular operations in UK agri-food SMEs. *J. Bus. Res.* 144, 1149–1162. <https://doi.org/10.1016/j.jbusres.2022.02.060>.
- Medvediev, I., Elisseyev, P., Lebid, I., & Sakno, O., 2020. A modelling approach to the transport support for the harvesting and transportation complex under uncertain conditions. 26th Technical and scientific conference, Transport, ecology – sustainable development, Varna, Bulgaria, 8–10 October 2020, 977, 012003. <https://doi.org/10.1088/1757-899X/977/1/012003>.
- Medvediev, Ie., Muzylyov, D., Shramenko, N., Nosko, P., Elisseyev, P., Ivanov, V., 2020. Design logical linguistic models to calculate necessity in trucks during agricultural cargoes logistics using fuzzy logic. *Acta Logistica* 7 (3), 155–166. <https://doi.org/10.22306/al.v7i3.165>.
- Minh, V.T., Katushin, D., Antonov, M., Veinthal, R., 2017. Regression models and fuzzy logic prediction of TBM Penetration rate. *Open Eng.* 7 (1), 60–68. <https://doi.org/10.1515/eng-2017-0012>.
- Mu, J., Wan, Z., 2010. A fuzzy approach for supply chain risk assessment. 2010 Seventh International Conference on Fuzzy Systems and Knowledge Discovery, Yantai, China, 2010, pp. 429–431. <https://doi.org/10.1109/FSKD.2010.5569620>.
- Muzylyov, D., Shramenko, N., 2020. Mathematical Model of Reverse Loading Advisability for Trucks Considering Idle Times. In: Karabegović, I. (Ed.). *In: New Technologies, Development and Application III. NT 2020. Lecture Notes in Networks and Systems*, 128. Springer, pp. 612–620. [https://doi.org/10.1007/978-3-030-46817-0\\_71](https://doi.org/10.1007/978-3-030-46817-0_71).
- Ngai, E., Wat, F., 2005. Fuzzy decision support system for risk analysis in e-commerce development. *Decis. Support Syst.* 40 (2), 235–255. <https://doi.org/10.1016/j.dss.2003.12.002>.
- Nikolić, M., Šelmić, M., Macura, D., Čalić, J., 2020. Bee colony optimization metaheuristic for fuzzy membership functions tuning. *Expert Syst. Appl.* 158, 113601. <https://doi.org/10.1016/j.eswa.2020.113601>.
- Nocera, F., Contento, A., Gardoni, P., 2023. Risk analysis of supply chains: the role of supporting structures and infrastructure. *Reliab. Eng. Syst. Saf.* 241, 109623. <https://doi.org/10.1016/j.res.2023.109623>.
- Pappas, I.O., Woodside, A.G., 2021. Fuzzy-set qualitative comparative analysis (fsQCA): guidelines for research practice in Information systems and marketing. *Int. J. Inf. Manag.* 58, 102310. <https://doi.org/10.1016/j.ijinfomgt.2021.102310>.
- Pasaribu, A., Syahputra, M., 2022. Comparison of fuzzy logic and multiple linear regression in forecasting rice production in toba district. *FARABI: jurnal matematika dan pendidikan. Matematika* 5 (2), 121–127. <https://doi.org/10.47662/farabi.v5i2.392>.
- Pathak, D.K., Shankar, R., Choudhary, A., 2020. Performance assessment framework based on competitive priorities for sustainable freight transportation systems. *Transp. Res. Part D: Transport. Environ.* 90, 102663. <https://doi.org/10.1016/j.trd.2020.102663>.
- Pavlenko, O., Velykodnyĭ, D.O., Lavrentieva, O.O., Filatov, S.V., 2020. The Procedures of Logistic Transport Systems Simulation into the Petri Nets Environment. *Proceedings of the 16th International Conference on ICT in Education, Research and Industrial Applications. Integration, Harmonization and Knowledge Transfer. Volume II: Workshops*, Kharkiv, Ukraine, 06–10 October 2020, 2732, pp. 854–868. Available at: <https://ceur-ws.org/Vol-2732/20200854.pdf>. [Accessed 20 February 2023].
- Pavlenko, O., Muzylyov, D., Shramenko, N., Caĝaňová, D., Ivanov, V., 2023. Mathematical Modeling as a Tool for Selecting a Rational Logistical Route in Multimodal Transport Systems. In: Caĝaňová, D., Hornáková, N. (Eds.), *Industry 4.0 Challenges in Smart Cities*, Springer, Cham. [https://doi.org/10.1007/978-3-030-92968-8\\_2](https://doi.org/10.1007/978-3-030-92968-8_2).
- Pavlenko, O., Muzylyov, D., Ivanov, V., Bartoszuk, M., Jozwik, J., 2023b. Management of the grain supply chain during the conflict period: case study Ukraine. *Acta Logistica* 10 (3), 393–402. <https://doi.org/10.22306/al.v10i3.406>.
- Picheta, B.R., Krever, M., Chernova, A., 2023. Russia pulls out of Ukraine grain deal, in potential blow to global food supplies. *CNN*, 17 July. [online] Available at: < <https://edition.cnn.com/2023/07/17/europe/russia-ukraine-grain-deal-intl/index.html> > [Accessed 20 Sept. 2023].
- Pitchforth, J., Mengersen, K.L., 2013. A proposed validation framework for expert elicited Bayesian Networks. *Expert Syst. Appl.* 40 (1), 162–167. <https://doi.org/10.1016/j.eswa.2012.07.026>.
- Pohudina, O., Morikova, A., Haidabrus, B., Kiyko, S., Druzhinin, E., 2021. Comparison of metaheuristic search methods for the task of choosing a rational set of measures to risks' respond. In: Nechyporuk, M., Pavlikov, V., Kritskiy, D. (Eds.), *Mechanical engineering – 2020, Lecture Notes in Networks and Systems*. Springer, pp. 657–666. [https://doi.org/10.1007/978-3-030-66717-7\\_56](https://doi.org/10.1007/978-3-030-66717-7_56).
- Polska, K., 2022. Ukraine tripled its agricultural product export in four months. *Deutsche Welle*. [online] Available at: < <https://www.dw.com/uk/ukraine-potroila-eksport-agroprodukcii-za-cotiri-misaci/a-63186686> > [Accessed 20 Sept. 2023].
- Prokudin, G., Chupaylenko, O., Dudnik, O., Prokudin, O., Dudnik, A., Svatko, V., 2018. Application of information technologies for the optimization of itinerary when delivering cargo by automobile transport. *Eastern-Eur. J. Enterprise Technol.* 2 (3(92)), 51–59. <https://doi.org/10.15587/1729-4061.2018.128907>.
- Prokudin, G., Chupaylenko, O., Lebid, V., Denys, O., Khotobnia, T., Nazarova, A., 2022. Logistics of freight transportation and customs service in international transportation. In: Prudius, I. (Ed.), *Logistics systems: technological and economic aspects of efficiency. PC TECHNOLOGY CENTER*, Kharkiv, pp. 38–74. <https://doi.org/10.15587/978-617-7319-66-4.ch2>.
- Rahman, T., Paul, S.K., Agarwal, R., Sarker, R., 2023. Overview of Supply Chain Risk and Disruption Management Tools, Techniques, and Approaches. In: Paul, S.K., Agarwal, R., Sarker, R.A., Rahman, T. (Eds.), *Supply Chain Risk and Disruption Management*. Springer, Singapore, pp. 1–22. [https://doi.org/10.1007/978-981-99-2629-9\\_1](https://doi.org/10.1007/978-981-99-2629-9_1).
- Rehman, S., Sahana, M., Dutta, S., Sajjad, H., Song, X., Imdad, K., Dou, J., 2020. Assessing subsidence susceptibility to coal mining using frequency ratio, statistical index and Mamdani fuzzy models: evidence from Raniganj coalfield, India. *Environ. Earth Sci.* 79, 380. <https://doi.org/10.1007/s12665-020-09119-8>.
- Resende, C.H.L., Lima-Junior, F.R., Carpinetti, L.C.R., 2023. Decision-making models for formulating and evaluating supplier development programs: A state-of-the-art review and research paths. *Transport. Res. Part E: Logist. Transport. Res.* 180, 103340. <https://doi.org/10.1016/j.tre.2023.103340>.
- Rodríguez, R.M., Martínez, L., Herrera, F., 2011. Hesitant Fuzzy Linguistic Term Sets. In: Wang, Y., Li, T. (Eds.), *In: Foundations of Intelligent Systems. Advances in Intelligent and Soft Computing*, 122. Springer, Berlin, Heidelberg, pp. 287–295. [https://doi.org/10.1007/978-3-642-25664-6\\_34](https://doi.org/10.1007/978-3-642-25664-6_34).
- Schmelzer, B., 2023. Random sets, copulas and related sets of probability measures. *Int. J. Approx. Reason.* 160, 108952. <https://doi.org/10.1016/j.ijar.2023.108952>.
- Sezer, S., Cetin, S., Atalay, A.E., 2011. Application of self tuning fuzzy logic control to full railway vehicle model. *Procedia Comput. Sci.* 6, 487–492. <https://doi.org/10.1016/j.procs.2011.08.090>.
- Shakhov, A., Pterska, V., Sherstiuĭ, O., Botsaniuk, V., Babayev, I., 2021. Mechanisms for the Effective Sharing of Risks of Seaport Concession Projects. *Proceedings of the 2nd International Workshop IT Project Management (ITPM 2021)*, Slavsko, Lviv region, Ukraine, 16–18 February 2021, 2851, pp. 34–44. Available at: <https://ceur-ws.org/Vol-2851/paper4.pdf> [Accessed 22 February 2023].
- Sharma, D., Singh, A., Kumar, A., Venkatesh, M., Venkatesh, V., 2021. Reconfiguration of food grain supply network amidst COVID-19 outbreak: an emerging economy perspective. *Ann. Oper. Res.* <https://doi.org/10.1007/s10479-021-04343-2>.

- Shtovba, S., Pankevych, O., 2018. Fuzzy technology-based cause detection of structural cracks of stone buildings. CEUR workshop proceedings 2105, pp. 209–218.
- Sridharan, M., 2021. Application of Mamdani fuzzy inference system in predicting the thermal performance of solar distillation still. *J Ambient Intell Human Comput* 12, 10305–10319. <https://doi.org/10.1007/s12652-020-02810-5>.
- State Transport Service of Ukraine, 2023. [online] Available at: < <http://dsbt.gov.ua> > [Accessed 20 Sept. 2023].
- Sun, J., Wang, H., Wang, M., 2023. Risk assessment of bauxite maritime logistics based on improved FMECA and fuzzy Bayesian network. *J. Mar. Sci. Eng.* 11 (4), 755. <https://doi.org/10.3390/jmse11040755>.
- Teodorović, D., Vukadinović, K., 1998. *Traffic Control and Transport Planning: A Fuzzy Sets and Neural Networks Approach*. Springer Science+Business Media, New York.
- Terrin, N., Schmid, C.H., Griffith, J.L., D'Agostino, R.B., Selker, H.P., 2003. External validity of predictive models: a comparison of logistic regression, classification trees, and neural networks. *J. Clin. Epidemiol.* 56 (8), 721–729. [https://doi.org/10.1016/S0895-4356\(03\)00120-3](https://doi.org/10.1016/S0895-4356(03)00120-3).
- Tomasiello, S., Alijani, Z., 2021. Fuzzy-based approaches for agri-food supply chains: a mini-review. *Soft Comput* 25, 7479–7492. <https://doi.org/10.1007/s00500-021-05707-3>.
- Tuncel, G., Alpan, G., 2010. Risk assessment and management for supply chain networks: a case study. *Comput. Ind.* 61 (3), 250–259. <https://doi.org/10.1016/j.compind.2009.09.008>.
- Turksen, I.B., Willson, I.A., 1995. A fuzzy set model for market share and preference prediction. *Eur. J. Oper. Res.* 82 (1), 39–52. [https://doi.org/10.1016/0377-2217\(93\)E0331-Q](https://doi.org/10.1016/0377-2217(93)E0331-Q).
- Ukrainian grain exports explained, n. d. The official website of the Council of the EU and the European Council. [online] Available at: < <https://www.consilium.europa.eu/en/infographics/ukrainian-grain-exports-explained/> > [Accessed 20 Sept. 2023].
- Ur Rehman, O., Ali, Y., 2021. Optimality study of China's crude oil imports through China Pakistan economic corridor using fuzzy TOPSIS and Cost-Benefit analysis. *Transport. Res. Part E: Logist. Transport. Rev.* 148, 102246. <https://doi.org/10.1016/j.tre.2021.102246>.
- Vafadarijoo, A., Moktadir, M.A., Paul, S.K., Ali, S.M., 2023. A novel grey multi-objective binary linear programming model for risk assessment in supply chain management. *Supply Chain Anal.* 2, 100012. <https://doi.org/10.1016/j.sca.2023.100012>.
- Végsőová, O., Straka, M., Kyšľa, K., 2020. The level of risk and decision-making in managing industrial activity with the elimination of negative environmental impacts. *Annual Set the Environ. Protect.* 22 (1), 130–143.
- Vesely, S., Klöckner, C.A., Dohnal, M., 2016. Predicting recycling behaviour: Comparison of a linear regression model and a fuzzy logic model. *Waste Manage.* 49, 530–536. <https://doi.org/10.1016/j.wasman.2015.12.025>.
- Volkov, V., Taran, I., Volkova, T., Pavlenko, O., Berezhnaja, N., 2020. Determining the efficient management system for a specialized transport enterprise. *Naukovyi Visnyk Natsionalnoho Hirnychoho Universytetu No 4*, 185–191. <https://doi.org/10.33271/nvngu/2020-4/185>.
- Vorkut, T., Volynets, L., Bilonog, O., Sopotsko, O., Levchenko, I., 2019. The model to optimize deliveries of perishable food products in supply chains. *Eastern-European J. Enterprise Technologies* 5 (3(101)), 43–50. <https://doi.org/10.15587/1729-4061.2019.177903>.
- Wan, C., Yan, X., Zhang, D., Qu, Z., Yang, Z., 2019. An advanced fuzzy Bayesian-based FMEA approach for assessing maritime supply chain risks. *Transport. Res. Part E: Logist. Transportat. Rev.* 125, 222–240. <https://doi.org/10.1016/j.tre.2019.03.011>.
- Waqas, U., Abd, R.A., Ismail, N.W., Kamal Basha, N., Umair, S., 2023. Influence of supply chain risk management and its mediating role on supply chain performance: perspectives from an agri-fresh produce. *Ann. Oper. Res.* 324 (1–2), 1399–1427. <https://doi.org/10.1007/s10479-022-04702-7>.
- Xu, B., Liu, W., Li, J., 2023. Resilience regulation strategy for container port supply chain under disruptive events. *J. Mar. Sci. Eng.* 11 (4), 732. <https://doi.org/10.3390/jmse11040732>.
- Yanar, T.A., Akyürek, Z., 2011. Fuzzy model tuning using simulated annealing. *Expert Syst. Appl.* 38 (7), 8159–8169. <https://doi.org/10.1016/j.eswa.2010.12.159>.
- Zadeh, L.A., 2009. Fuzzy Logic. In: Meyers, R. (Ed.), *Encyclopedia of Complexity and Systems Science*, Springer, New York, pp. 3985–4009. [https://doi.org/10.1007/978-0-387-30440-3\\_234](https://doi.org/10.1007/978-0-387-30440-3_234).
- Zandi, P., Rahmani, M., Khanian, M., Mosavi, A., 2020. Agricultural Risk management using Fuzzy TOPSIS analytical hierarchy process (AHP) and failure mode and effects analysis (FMEA). *Agriculture* 10 (11), 504. <https://doi.org/10.3390/agriculture10110504>.
- Zhao, G., Liu, S., Lopez, C., 2017. A Literature Review on Risk Sources and Resilience Factors in Agri-Food Supply Chains. In: Camarinha-Matos, L., Afsarmanesh, H., Fornasiero, R. (Eds.), *In: Collaboration in a Data-Rich World. PRO-VE 2017. IFIP Advances in Information and Communication Technology*, 506. Springer, pp. 739–752. [https://doi.org/10.1007/978-3-319-65151-4\\_66](https://doi.org/10.1007/978-3-319-65151-4_66).
- Zharikova, A., 2023. "Kernel", Louis Dreyfus Company and Cargill became leaders in grain exports in 2022-2023 MP. *Economic Truth*, 30 October. [online] Available at: < <https://www.epravda.com.ua/news/2023/10/30/706004/> > [Accessed 31 Oct. 2023].