

# A Novel Sensor for Measuring Temperature Profile During the Thermoablation\*

Adam Bujnowski and Jerzy Wtorek

**Abstract**—A novel approach for monitoring a temperature distribution inside a tissue during thermoablation is presented in the paper. A thermal profile is measured using a set of serially connected thermistors each bypassed by a capacitor. This technique allows a two-wire and simultaneous multi-point measurements using a multi-frequency measurement of electrical impedance. It is shown that application signals of appropriately selected frequency allows simultaneous measurement of temperature at five distinct points. This technique can be utilized in the assisting of a thermoablation process, and in other applications based on resistive or capacitive sensors.

## I. INTRODUCTION

A thermoablation is a surgical intervention that is using a high density electric current of a radio-wave frequency (RF). The current density is determined by electrodes' size and typically, a reference one, is of relatively large area while another, a working one, is a much smaller. Thus, a high density of the current in a tissue is obtained in a volume close to the working electrode and it causes temperature rise high enough to damage of the tissue's structure.

Nowadays, this technique is used to treat of a liver, the lungs, the kidneys and other organs tumors mostly in case of cancer. Usually a single thermistor is located close to the electrode tip in order to monitor its temperature. This gives information on the temperature in the center of thermoablated volume. There is no information about expected radius of cells and protein damage caused by the heat. Thermoablation process is supervised by monitoring of the electrical impedance between electrodes. Additionally, it is possible to supervise thermoablation process by means of impedance spectroscopy [1].

The temperature can be measured using several methods. These can be divided into contact and contact-less. Contact temperature measurement techniques are using thermal sensors that converts surrounding temperature into voltage, resistance, frequency etc. Measured value depends on the sensor technology and sensor-area contact properties. By measuring temperature one can get single reading which is average over sensor volumetric temperature distribution.

\*This work was partially supported by Statutory Funds of Electronics, Telecommunications and Informatics Faculty, Gdansk University of Technology.

Adam Bujnowski is with the Biomedical Engineering Department, Faculty of Electronics, Telecommunication and Informatics, Gdansk University of Technology, Narutowicza 11/12, 80-233 Gdańsk, Poland (e-mail: [bujnows@biomed.eti.pg.gda.pl](mailto:bujnows@biomed.eti.pg.gda.pl)).

Jerzy Wtorek is with the Biomedical Engineering Department, Faculty of Electronics, Telecommunication and Informatics, Gdansk University of Technology, Narutowicza 11/12, 80-233 Gdańsk, Poland (corresponding author, phone: 48 58 34 71 384; e-mail: [Jerzy.Wtorek@eti.pg.gda.pl](mailto:Jerzy.Wtorek@eti.pg.gda.pl)).

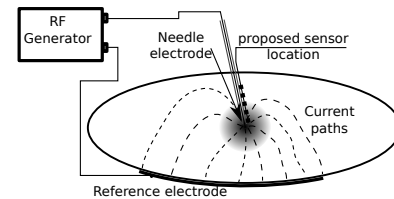

Fig. 1. A common configuration of electrodes used in thermoablation, bold dots indicate locations of temperature sensors

Contact-less techniques are measuring temperature as a result of body's emission of electromagnetic radiation. Depending on the technology used it is possible to measure average temperature over specified area or using thermovision - thermal images. Unfortunately, neither contact nor contactless techniques is able to measure profile of the temperature inside the body. There are some attempts to apply the active thermography [2] to this task, however they are limited only to examination of a surface temperature distribution. The temperature profile of the deeper structures can be measured using either single sensor movable within the body or set (arranged in line or array) fixed sensors buried in the body. Nowadays modern techniques such as the magnetic resonance (MRI) [6] or ultrasound thermometry [7] are investigated for supervising of thermoablation progress. The MRI thermography requires expensive instrumentation and additional precautions to be taken related to high magnetic fields. Ultrasonic technique is commonly used to assist thermoablation process. It is used both, for in-depth navigation and the ablation procedure assurance as well.

To measure a temperature profile a row of thermistors aligned along the needle is proposed. However, this approach involves a complicated wiring and multiplexing. In some applications, there is a demand for minimization of the sensor matrix both in size and a number of the wires. As an example - during a tumor thermoablation it is important to know the size of a destroyed region e.g. in order to finish the procedure properly [3].

A multi-point sensor of temperature placed along the working electrode (Fig. 1) that is able to deliver a temperature profile along the electrode is presented in the paper. Moreover the sensor is utilizing only two wires to connect the measurement unit.

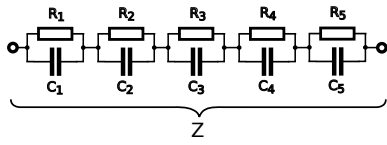

Fig. 2. A schematic diagram of the proposed sensor

## II. METHODS

### A. A measurement unit

The developed sensor contains a serial connection of R-C circuits (Fig. 2). In order to measure temperature at  $N$  points simultaneously and exactly the set of  $N$  thermo-elements should be used. Each thermistor is bypassed by appropriately selected capacitor. An NTC type thermistor was used in the developed model of the sensor.

Assume, the elements  $R_1$ - $R_5$  are thermistors and  $C_1 \neq C_2 \neq C_3 \neq C_4 \neq C_5$ . The impedance of such circuit can be written as follow:

$$Z(\omega) = \sum_{n=1}^N \frac{R_n - j\omega R_n^2 C_n}{\omega^2 R_n^2 C_n^2 + 1} \quad (1)$$

As it can be seen, impedance of such circuit is frequency dependent so the measurement circuit should be able to measure impedance spectrum over given frequency range.

### B. A measurement procedure

The measurement system contains the following circuits: IA - instrumentation amplifier, 1 - voltage follower, Demod - demodulator, Sine sweep - a voltage controlled sine generator (Fig. 3). The impedance,  $Z(\omega)$ , is over a frequency range enabling to recover all time constants. Assume  $C_1 > C_2 > \dots > C_5$  and at given temperature  $R_1 = R_2 = \dots = R_5$ . Then denote the  $\tau_n = R_n C_n$ . Frequency span should include all time constants with some margin:

$$f_{min} < \min_n \tau_n \quad (2)$$

$$f_{max} > \max_n \tau_n \quad (3)$$

The  $Z(\omega)$  function must allow identification of every individual time constant. Each temperature can be read by finding the resistance of thermistors and mapped to the temperature according thermistor character ( $R_{th} = f(T)$ ).

A resistance of the NTC thermistor at given temperature  $T$  is described by relationship:

$$R = R_{25} e^{\frac{B}{T}} \quad (4)$$

where  $B$  is material dependent factor and  $R_{25}$  is a resistance of the thermistor at  $25^\circ C$ . The measured resistance allows determination of the temperature as follows:

$$T = \frac{B}{\ln\left(\frac{R}{R_{25}}\right)} \quad (5)$$

In general, the sensor could contain  $N$  thermistors however, in the developed one  $N = 6$  was used. Thus, the problem was to determine a resistance of each thermistor

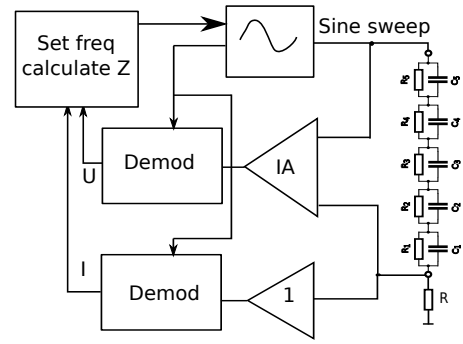

Fig. 3. A block diagram of the measurement system - description in the text

basing on the measured impedance spectrum. Let's denote  $R = [R_1, R_2, R_3, R_4, R_5, R_6]$  to be a vector of searched values. Assume that  $C_1 \dots C_N$  are known and characterized by negligible temperature coefficient. A least square approach is utilized. The frequency "points",  $\omega_i$ , were selected to be equally spaced, however in a logarithmic scale. A following function is minimized:

$$\min ||Z_p(\omega_i) - Z(\omega_i)||^2 \quad (6)$$

where:  $Z_p$  - vector obtained from measurements,  $Z$  - the calculated impedance data from the model. Both vectors contain the values of measured impedance for specified pulsations  $\omega_i$ . From (1) it could be written:

$$Z(\omega_i) = f(R) \quad (7)$$

Rewriting it into differential form:

$$\Delta(Z(\omega_i)) = Res(\omega_i) = f(\Delta R) \quad (8)$$

where  $Res(\omega_i) = (Z_p(\omega_i) - Z(\omega_i))$  is a residuum. If we assume that:

$$Z(\omega_i) = f(R_o) \quad (9)$$

where  $R_o$  is an initial vector of the thermistor resistances that will produce  $Z(\omega)$  impedance data we can calculate unknown value of  $R$  as:

$$R = R_o + \Delta R \quad (10)$$

Rewriting equation (8) in matrix form :

$$[\Delta Z(\omega_i)] = [J] \cdot [\Delta R] \quad (11)$$

where  $J$  is a Jacobian matrix in form:

$$J = \left[ \frac{\partial Z(\omega_i)}{\partial R_1} \quad \frac{\partial Z(\omega_i)}{\partial R_2} \quad \dots \quad \frac{\partial Z(\omega_i)}{\partial R_n} \right] \quad (12)$$

then:

$$[\Delta R] = [J]^{-1} \cdot [Res(\omega_i)] \quad (13)$$

The matrix  $J$  is not a square one (more measurements than unknowns - overdetermined case), so methods of pseudo-inversion and regularization should be used. To simplify calculations a *lsqnonlin* function, available both in Matlab and Octave environments [4] [5] was used. To make the

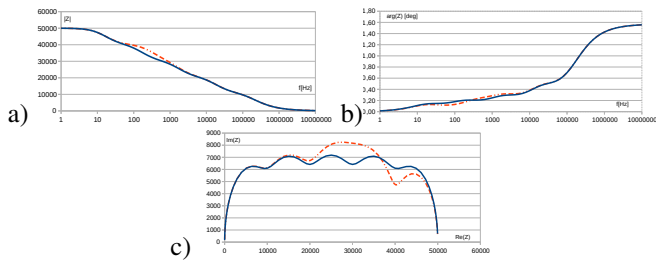

Fig. 4. Modulus (a) and phase (b) and impedance plane plot (c) of the impedance of the sensor with "initial" state (continuous) and with  $R_2$  changed (dotted)

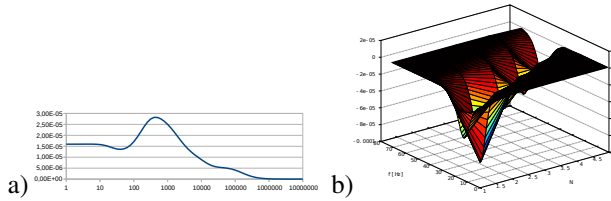

Fig. 5. The calculated residua a) as difference between modulus of "measured" and model data and Jacobian b)

problem solvable it was necessary to select the capacitance values carefully as well as the set of measurement signal frequency.

### C. A validation method

Measurement data were validated using thermal camera. Validation was performed by heating one of the tip of the sensor by constant air flow. The thermograms were recorded and after temperature distribution stabilization the impedance was measured and then temperature values were determined.

## III. RESULTS

Example of a simulated impedance spectrum for 5-time constant sensor is presented in the Fig. 4. A continuous line presents the impedance calculated for initial set of  $R$  while a dotted one depicts a simulated impedance plot for one thermistor of altered value.

For the initial state equal temperature  $25^{\circ}C$  of each thermistor was assumed. For the  $10k\Omega$  thermistors all resistances are equal to  $10k\Omega$ . Capacitors were selected priori to have values of  $C = [1.0e - 06, 1.0e - 07, 1.0e - 08, 1.0e - 09, 1.0e - 10]$  which are readily available on the market as  $1\mu F$ ,  $100nF$ ,  $10nF$ ,  $1nF$  and  $100pF$  respectively. For the simulation we have selected frequency span from  $1Hz$  up to  $10MHz$  in 71 discrete points.

The  $lsqnonlin$  function can not work directly on complex data so for the calculation of the residual vector modulus of the impedance data were used. As an example residual values can be shown in Fig. 5a).

$$Res(\omega_i) = |Z_p(\omega_i)| - |Z(\omega_i)| \quad (14)$$

In the standard approach values of the Jacobian have to be calculated on the basis of the problem definition. In the  $lsqnonlin$  function Jacobian can be calculated by the

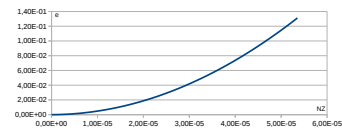

Fig. 6. Reconstruction error vs. noise in the impedance data

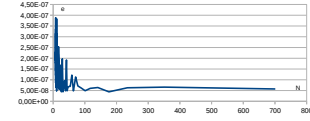

Fig. 7. A reconstruction error as a function of M, a number of impedance measurements done at different frequency

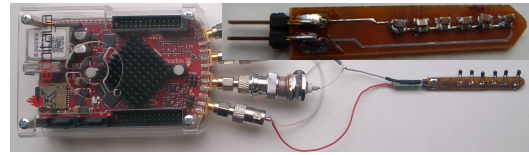

Fig. 8. The measurement system based on the RedPitaya board with two different sensors

function as regularization factor. Calculated values are shown in Fig 5b).

For synthetic data the calculated results of thermistors resistances were accurate. However, in real cases the measurements data contain noise. In such case the reconstructed resistances value may be less accurate. Numerical experiments basing on inclusion of an additive noise have been performed. An error defined as difference between actual data  $R_a$  and reconstructed values  $R_g$  has been calculated. Moreover, a level of noise in the measurements data leads to bigger errors in temperature reconstruction. It is important to reduce noise in the measurements. This can be achieved by applying an averaging technique, but unfortunately it leads to an increase in measurement time.

$$e = ||R_g - R_a||^2 \quad (15)$$

Additionally for proposed application measurement procedure should be fast. Measurements can be performed during short pause between ablation procedure only as high power RF currents will introduce measurement noise.

Reducing number of frequency points lead to reduce measurement time. However to small number of points will lead to increase reconstruction error. In Fig. 7 a reconstruction error vs. number of frequency points in a given frequency range is shown. From this simulation it can be seen that for a very small number of measurement points the error is significant. However, an increase of the measurement points number is less important than a selection of an adequate frequency set. The error curve presented in Fig. 7 illustrates this phenomena. For M less than 200 reconstruction points the error is unstable (increases and decreases) supporting the above statement.

The sensor prototype has been developed using custom designed printed circuit board with manually soldered 12 elements ( $N=6$ ) (Fig.8).

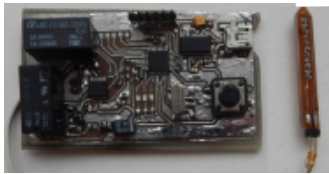

Fig. 9. A custom measurement system based on AD5933 IC

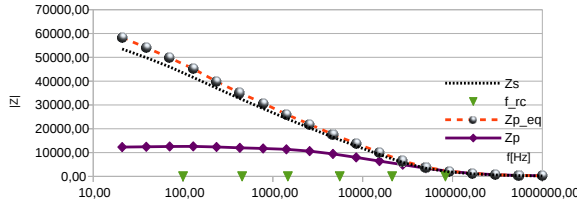

Fig. 10. Results of impedance spectroscopy using measurement circuit presented in the Fig. 8

TABLE I

RECONSTRUCTED RESISTANCE OF THERMISTORS (DATA IN FIG.10)

	$R_1 [\Omega]$	$R_2 [\Omega]$	$R_3 [\Omega]$	$R_4 [\Omega]$	$R_5 [\Omega]$	$R_6 [\Omega]$
$Z_{peq}$	10022	10013	10035	10447	10321	10112
$Z_p$	455	520	891	2065	2168	5895

TABLE II

RECONSTRUCTED TEMPERATURES (DATA IN FIG.10)

	$T_1 [^{\circ}C]$	$T_2 [^{\circ}C]$	$T_3 [^{\circ}C]$	$T_4 [^{\circ}C]$	$T_5 [^{\circ}C]$	$T_6 [^{\circ}C]$
$Z_{peq}$	24.96	24.99	24.93	23.88	24.20	24.73
$Z_p$	109.3	107.75	98.47	72.23	70.39	38.78

During experiments professional impedance analyser Novocontrol Alpha has been utilized. In order to make the measurement system mobile RedPitaya measurement board was prepared to act as an impedance meter (See Fig. 8). Impedance data were loaded via network and analysed in the PC. In Fig.10 results of two experiments are presented. At first all sensors were exposed for the same ambient temperature of  $25^{\circ}C$  ( $Z_{peq}$ ). During second experiment one of the sensor ends was heated by  $100^{\circ}C$  hot-air flow ( $Z_p$ ;  $Z_s$  represents model data,  $t_{rc}$  - characteristic frequency of the model). Results of measurements performed using the RedPitaya-based system were in a good agreement with calculated ones (Fig.10, Table I and Table II). Finally, a custom board using AD5933 impedance analyzer was built and tested (Fig. 9).

Time duration of the temperature profile reconstruction from the measured data is approximately 140 ms using a modern PC for 71 measurement points. A simple scan of impedance data for 71 discrete frequencies takes several seconds (about 20) using both Alpha Novocontrol and RedPitaya instrumentation. If an averaging technique is used for noise reduction the measurement time increases.

Results of validation procedure are shown in the Fig. 11 and presented in the Table III. Differences between temperatures are acceptable. There were several similar tests performed and obtained results were satisfactory.

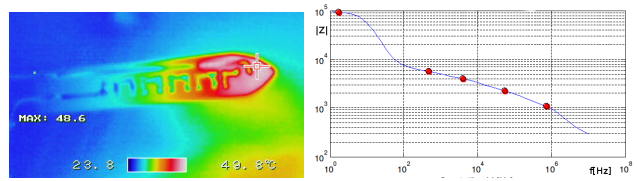

Fig. 11. Validation of the measurement data using thermovision camera a) - thermal image, b) modulus of measured impedance.

TABLE III

VALIDATION OF THE MEASUREMENT USING THERMOVISION CAMERA

	$T_1 [^{\circ}C]$	$T_2 [^{\circ}C]$	$T_3 [^{\circ}C]$	$T_4 [^{\circ}C]$	$T_5 [^{\circ}C]$
Reconstructed	27.5	30.0	30.7	39.0	44.3
IR camera	28.5	30.9	31.2	39.6	44.1

#### IV. DISCUSSION AND CONCLUSION

A novel construction of the temperature sensor is presented in the paper. It allows measurement of temperature profile at N points simultaneously by using only the two wire sensor. The sensor may be miniaturized and integrated with the heater (needle) used for low-invasive surgery like thermoablation. The measurement procedure was also presented and studied. For medical applications frequency range and amplitude of the measurement signals should be carefully selected to assure appropriate precision of the sensor.

A further study should involve investigation of mutual thermal influence of the sensors and methods of measurement time reduction as well as the applicable number of temperature sensors that can be used for specified frequency range. Additionally new measurement techniques should be investigated that benefits reduction of measurement time. This can be achieved either by reducing number of frequency in measurements or by applying another measurement technique like multi-frequency excitation of time-domain approach. A similar measurement technique may be applied to any other resistive or capacitive sensor (pressure, tension, etc.).

#### REFERENCES

- [1] K. Lukaszewicz, J. Wtorek, A. Bujnowski, and J. Skokowski, Monitoring of breast tissue thermoablation by means of impedance measurements. *J. Phys. Conf. Ser.*, 224(1):012136, 2010
- [2] J. Ruminski, M. Kaczmarek, A. Renkielska et al., Thermal parametric imaging in the evaluation of skin burn depth. *IEEE Transaction on Biomedical Engineering*, vol. 54(2), pp. 303-312, 2007
- [3] C.L. Brace, Radiofrequency and Microwave Ablation of the Liver, Lung, Kidney and Bone: What Are the Differences: Organ-Specific Thermal Ablation. *Current problems in diagnostic radiology* 38.3 (2009): 135143. PMC. Web. 2 Feb. 2017.
- [4] Matlab manual for *lsqnonlin* <https://www.mathworks.com/help/optim/ug/lsqnonlin.html> [access: 30.01.2017]
- [5] Octave manual for *lsqnonlin* <https://octave.sourceforge.io/optim/function/lsqnonlin.html> [access: 30.01.2017]
- [6] V. Rieke et al., "Referenceless MR Thermometry for Monitoring Thermal Ablation in the Prostate," in *IEEE Transactions on Medical Imaging*, vol. 26, no.6, pp. 813-821, 2007. doi: 10.1109/TMI.2007.892647 URL: <http://ieeexplore.ieee.org/stamp/stamp.jsp?tp=&arnumber=4214884&isnumber=4214872>[access: 24.04.2017]
- [7] M. A. Lewis, R. M. Staruch, and R. Chopra, Thermometry and Ablation Monitoring with Ultrasound. *International Journal of Hyperthermia: The Official Journal of European Society for Hyperthermic Oncology, North American Hyperthermia Group*, (2015), 31(2), 163181. <http://doi.org/10.3109/02656736.2015.1009180>