

# Air-cooled photovoltaic roof tile as an example of the BIPVT system – an experimental study on the energy and exergy performance

Jan Wajs\*, Aleksandra Golabek, Roksana Bochniak, Dariusz Mikielawicz

Gdansk University of Technology, Faculty of Mechanical Engineering, Department of Energy and Industrial Apparatus, Narutowicza 11/12, 80-233 Gdansk, Poland;

\* Correspondence: [jan.wajs@pg.edu.pl](mailto:jan.wajs@pg.edu.pl); Tel.: +48-583472830

**Abstract:** The air-cooled photovoltaic tile is a subject of presented investigations, which focused on improving the overall system efficiency of PV tiles with heat recovery. The operational efficiency of a PV roof tile, together with the construction optimising the air cooling efficiency, were the main points of plans realized at this research stage. The article describes the experimental research consisting of the assessment of electrical, thermal, and total efficiency, as well as exergy efficiency and parameters of a commercial photovoltaic (PV) roof tile, which back wall was cooled by flowing air. An influence of various cooling duct depths and various volumetric flow rates on the system operation was analysed. During the tests, a solar light simulator and a radial fan, providing the assumed volumetric flow rate of cooling air were used. It has been proven that the depth of the cooling duct and the air volumetric flow rate have a crucial impact on the obtained results. Air cooling the back wall of the PV roof tile, lowered the average surface temperature by a maximum of 6.3 K, while the temperature difference, between the surface next to the cooling air inlet and the surface next to its outlet, was a maximum of 23.4 K. Both values were obtained for air cooling with a volumetric flow rate equal to 4 m<sup>3</sup>/h and a channel depth of 25 mm, with a solar irradiance of 900 W/m<sup>2</sup>. The overall efficiency was calculated as a sum of the electrical and thermal efficiencies. Its maximal obtained value was about 32%, wherein the highest thermal efficiency was at the level of 27%. An exergy analysis was performed and the exergy efficiency between 5.08 % and 9.94 % was determined. These results are promising for future utilization of the system consisted of the PV roof tiles together with the cooling ducts.

## Keywords:

Experimental study, Heat recovery, Photovoltaic roof tile, Solar light simulator, Energy analysis, Exergy analysis.

## 1. Introduction

Electricity is a source of energy that configures the basis for most processes affecting development of technology and improving the comfort of human life. Such development, however, requires increasing energy consumption, which renders a problem in the light of environmental protection. It comes from the fact, that generation of electricity in the conventional power plants is related to high greenhouse gas emissions to the atmosphere as well as other pollutions. This situation has several adverse effects, including currently noticeable climate changes, which have a negative impact on the ecosystem, translated directly into human health and life [1]. One of the ways to stop these changes is reduction of the carbon dioxide emissions to the atmosphere. It is seen as the contribution to the limitation of the global warming impact [1]. According to the Paris agreement, an increase in the world temperature by 2100 should not to exceed 2 °C compared to pre-industrial times [2]. It is also oriented on the reduction of this limit down to 1.5 °C [2]. The presented goals demand the retreat from high-emission methods of electricity generation, like burning fossil fuels, and development of unconventional energy methods, based, among the others, on renewable energy sources [1]. One of these renewable energy sources is the solar radiation energy, which is regarded as the largest source of energy without harmful emissions [3]. In addition, the Earth's surface within an hour reaches such an enough quantity ( $4.3 \times 10^{20}$  J), namely the amount that would meet the annual energy demand on our planet ( $4.1 \times 10^{20}$  J) [3]. Due to these issues, more and more effective concepts are being sought for the conversion of solar energy into electricity. Photovoltaic cells are amongst the fundamental solutions of such an issue. Currently, one of the most commonly used and best-known cell types are the elements made of the monocrystalline

silicon, however their efficiency strongly depends on their operating temperature and decreases by about 0.45 % for every degree of its increase [4, 5]. In order to increase the power they generate, they are usually installed in the form of panels.

Development of the BIPV (Building-Integrated Photovoltaic) technology depends strongly on the legal regulations in the field of zero energy buildings [6]. This technology is based on the usage of the photovoltaic panels, which are an integral part of buildings - including roofs and external walls. Recently, the solutions based on the photovoltaic roof tiles, generating the electricity and serving as the roofing, are gaining popularity [7]. Such roof tiles are also attractive in terms of aesthetics, therefore their replacement at some roof sections or at the entire roof does not negatively affect its appearance. The way of their installation is also similar to the installation of traditional tiles. This eliminates a need of additional racks mounting, as is the case for traditional photovoltaic panels.

Along with increase in the solar irradiance, which has a positive effect on the power generated by the photovoltaic cells, their operating temperature also increases, which reduces their electrical efficiency. Only a small part (6-20 %) of the solar radiation energy is converted into electricity; the rest is converted into heat, which increases the operating temperature of the cells [8]. Therefore, the solutions that reduce this temperature and utilize the recovered heat for other purposes (for example for heating of the rooms) are still being sought. Such solutions were used in Photovoltaic-Thermal (PVT) and Building-Integrated Photovoltaic-Thermal (BIPVT) technologies where installations, being an integral parts of the buildings, are considered [7]. They are based on the usage of various heat transfer processes, including heat pipes, jet impingement, and air flow cooling, phase change materials (PCM), liquid immersion/submerging, passive heat sink, microchannels, (active heat sink) and are widely described in the literature [9-12].

However, taking into account, that the photovoltaic roof tiles are installed at a considerable altitude and often in the countries with high potential of photovoltaics [13], but limited access to water, the article focuses on methods that utilize the air as a heat recovery fluid. Shashavar et al. [14] investigated the cooling effect of ventilation and exhaust air on the performance of PV panels at various months. They reported an increase in the electricity production of 10.1 % using the exhaust air, and 7.2 % using ventilation air, as the coolants. Similar considerations were performed by the scientists from Algeria (Ahmed-Dahmane et al. [15]) who, by reducing the operating temperature of the photovoltaic panel with exhaust air, improved its electrical efficiency and prevented its overheating during hot weather. In addition, during the winter months, the air, which warmed up during the panel cooling, was used as pre-heated air in the ventilation system. In another experimental study, the air was used as a cooling medium for the photovoltaic panel, and it was directed to the ventilation system (as a pre-heated fresh air), thereby obtaining an improvement in the panel's electrical efficiency amounting to about 15 %, as well as thermal efficiency by 22 % [16]. The impact of using DC (Direct Current) fans to cool the rear wall of the photovoltaic panel was also considered. A positive effect of lowering its operating temperature along with the increase in the number of fans, giving an increase in generated power was obtained [17].

Subsequent studies focused on the analysis of the impact of varying the flow velocity and mass flow rate of cooling air, as well as of the depth of the cooling duct on operating parameters and the total efficiency of the air-based PVT collectors. Bambrook and Sproul [18], in their experimental research proved that with the increase in the mass flow rate of the air cooling the rear wall of the photovoltaic panel, significantly increases thermal efficiency (from 28 to 55 %) and electrical efficiency (from 10.6 to 12.2 %). In turn, Kasaeian et al. [19] conducted experimental tests for various air mass flow rates and different cooling duct depths. By increasing the mass flow rate from 0.018 to 0.06 kg/s, they obtained an increase in the overall efficiency, while a change in the depth of the cooling duct from 5 to 10 and 15 cm respectively caused a decrease in thermal efficiency, but did not affect the change in the electrical efficiency. The highest thermal efficiency of 31 % was obtained for a channel with a depth of 5 cm and air mass flow rate of 0.06 kg/s.

Numerical simulations of the air-based PVT collector have shown, that as the cooling mass flow rate increases, the collector's overall efficiency increases and for a mass flow rate of 3 kg/s is over 70 %, but with the increase of the cooling duct depth the total efficiency decreases [20]. Abdullah et al. [21] came to similar conclusions regarding increasing mass flow rate and depth of the cooling channel. Kaiser et al. [22] conducted experimental studies, in which they proved, that by increasing the velocity of air flowing along the rear wall of the photovoltaic panel from 0.5 m/s (which corresponds to natural convection conditions) to 6 m/s, the power generation increases by over 19 %. Touafek et al. [23] designed and experimentally tested a new configuration of the PVT collector with a metal absorber with rectangular fins. They proved, that with increasing the air mass flow rate, the thermal efficiency of the PVT collector increased (from 10 % to over 80 %), while the use of heat, received in the form of flowing air, also improved the electrical efficiency of the photovoltaic panel.

The above mentioned background indicate the need for new methods, which allow the highest amount of heat removal from the photovoltaic panels, thanks to which it becomes possible to use the heated cooling medium, for example, for ventilation purposes. Similarly, the presented methods can be used when designing a roof built of photovoltaic roof tiles. The owner of such roof, would not only receive electricity that he can be used in the building, but also heated air, which can be used to heat rooms or, for example, as a lower source of an air heat pump.

The article presents experimental research consisting of the assessment of electrical, thermal, and total efficiency, as well as exergy efficiency and parameters of a photovoltaic roof tile, where the back wall was cooled by means of passing air. Two depths (25 mm and 51 mm) of the cooling duct and various air volumetric flow rates were analysed. During the tests, a solar light simulator was used, while the radial fan provided the assumed volumetric flow rate of cooling air. Authors in their previous publication [13], made the preliminary assessment of the heat removal possibilities from the solar roof tile and an impact of this process on the parameters of its work.

## 2. The experimental setup

A dedicated experimental system, schematically shown in Fig. 1, was developed at Department of Energy and Industrial Apparatus, Gdansk University of Technology. The photos of the experimental setup components are shown in Fig. 2. This study focuses on the analysis of a single commercial photovoltaic roof tile, where the characteristics of the construction and electrical parameters have been presented in Table 1 [13,24]. The tile consisted of nine monocrystalline silicon solar cells [13].

During the experiment, the PV roof tile was placed in the wooden casing, which was designed to reproduce conditions on a real roof. In the casing the special fins (with a width of 20 mm, a length of 400 mm and a height of 51 mm – for the duct depth of 51 mm or a height of 25 mm – for the duct depth of 25 mm), which directed the air flow, were attached [13]. Figure 3 presents two variants of designed casings with different depths of the air duct. The first depth of the air duct was 51 mm – this value comes from the typical way of mounting the PV roof tiles on the roof, which are hanged on metal hooks, attached to the roof battens and reinforced by the steel cable [24]. Additionally, the obtained results were compared with the results for the duct depth equal to 25 mm.

To ensure a wide range of solar irradiance at the laboratory conditions, the solar light simulator (Fig. 1 and Fig. 2(b)) was used. It consists of 20 lamps with a total power of 10 kW [13]. The use of many halogen lamps, according to the literature [25], allows to develop an acceptable imitation of natural solar radiation. The light beam, which is responsible for the obtained solar irradiance value, is controlled by adjusting the lamps supply voltage [13]. The distance between the examined PV roof tile and the solar light simulator was 1.6 m, because the greater distance did not ensure obtaining the solar irradiance at the required level of 900 W/m<sup>2</sup>. The surface of the examined PV roof tile was parallel to the surface of the simulator.

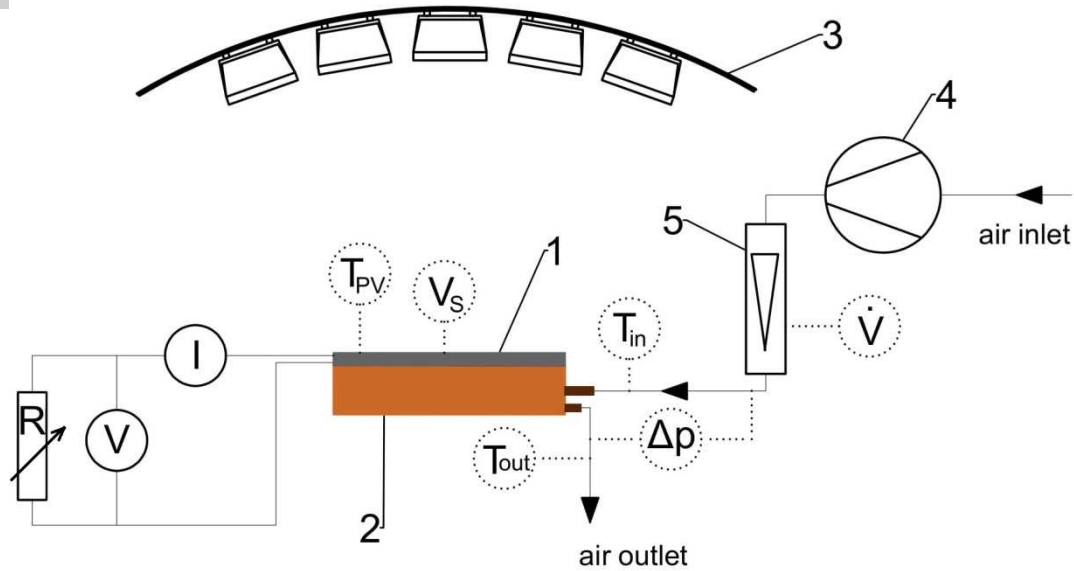

**Fig. 1.** Schematic diagram of the experimental setup: 1 – PV roof tile, 2 – casing with air ducts, 3 – solar light simulator, 4 – fan, 5 – rotameter,  $\dot{V}$  – volume flow rate,  $T_{in}$  – air inlet temperature,  $T_{out}$  – air outlet temperature,  $\Delta p$  – pressure drop,  $V_s$  – solarimeter signal,  $T_{PV}$  – temperature of PV roof tile,  $I$  – ammeter,  $V$  – voltmeter,  $R$  – slide resistor

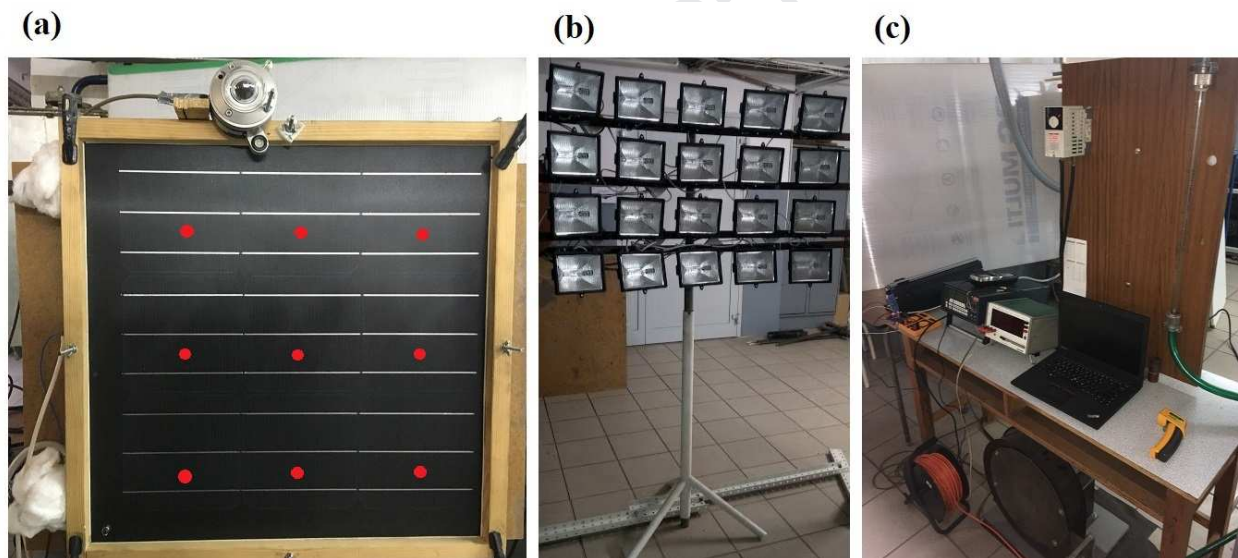

**Fig. 2.** The photos of the experimental setup elements: (a) PV roof tile (red dots – places of the temperature measurements on the PV roof tile surface), (b) solar light simulator, (c) acquisition system.

**Table 1.**

Photovoltaic roof tile details.

Detail/ Parameter	Value	Unit
Cell material	Monocrystalline silicon	-
Dimension of the cell	156 x 156	mm
Module dimensions	540 x 540	mm
Glass thickness	3.2	mm
Operating temperature	-40 to +80	°C
Nominal power	35	W
Tolerance (in Standard Test Conditions)	± 3	%
The maximum system voltage (DC)	1000	V



Operating voltage	4.5	V
Operating current	7.8	A
Unloaded voltage	4.9	V
Short-circuit current	8.2	A

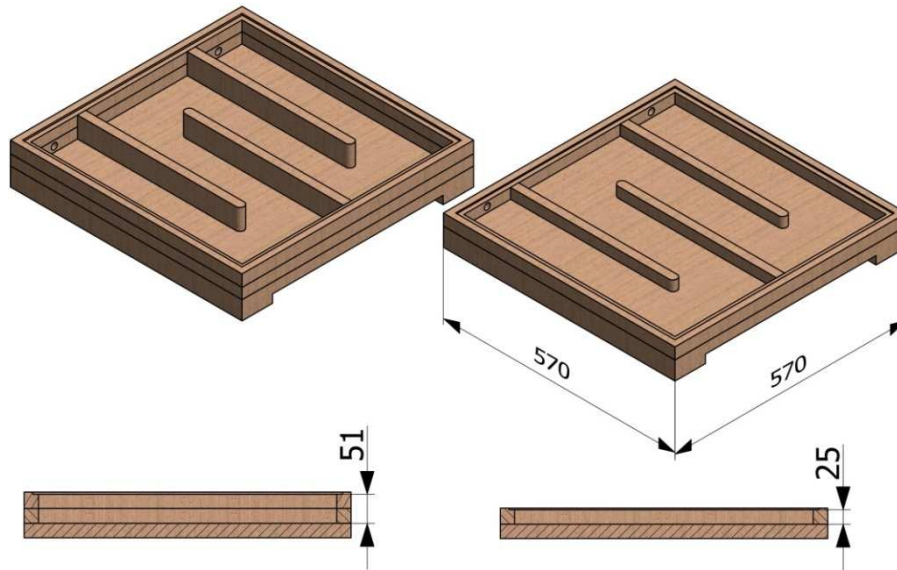

**Fig. 3.** Axonometric views of the PV roof tile casing with their cross-sections for two depth of air duct:  $H = 51$  mm and  $H = 25$  mm.

During the experiment, the acquisition system allowed to measure the basic parameters related to the PV roof tile work and its cooling. Following, there are the short descriptions of its particular components. The solarimeter (Kipp & Zonen CM6B) measured the solar irradiance. It was mounted on the top of the examined PV roof tile (see Fig. 2(a)), and its output signal was the voltage,  $V_s$ . The voltage was measured by the digital voltmeter Meratronik V534 and converted into the solar irradiance using a sensitivity index equal to  $11.44 \times 10^{-6}$  V/(W/m<sup>2</sup>) (producer's data). The mini pyrometer (Fluke 62) measured the temperature on the PV roof tile surface  $T_{PV}$  in the places marked by the red dots in Fig. 2(a). The electrical current  $I$  and the voltage  $V$  were measured by DT-830BUZ and DT-830BS multimeters and by using a slide resistor  $R$ . The air was flowing in an open loop (the heated air was removed to the environment) – the flow was provided by a radial fan, and the rotameter (Rol-164) measured a volumetric flow rate of the cooling medium. An inflow of the air at temperature  $T_{in}$  was through the bottom collector, whereas an outflow of the air at temperature  $T_{out}$  was through the top collector. The inlet and outlet air temperature values were measured by T-type thermocouples, and the signal was recorded by the acquisition system component Cropico-3001 TC. The pressure drop  $\Delta p$  was measured by a multifunctional measuring device Testo 435. Table 2 lists the measuring equipment together with their measurement accuracy utilized during experiments.

**Table 2**

Components of the acquisition system together with their measurement accuracies.

Measured Parameter	Device Name	Measurement Error
$T_{in}, T_{out}$	Cropico-3001 TC/Pt 100	$\pm 0.01$ K
$V$	DT-830B	$\pm 0.1$ V
$I$	DT-830BUZ	$\pm 0.2$ A
$\dot{V}$	Rol-164	$\pm 0.1$ m <sup>3</sup> /h
$T_{PV}$	Fluke 62 mini	$\pm 1.5$ K
$V_s$	Kipp & Zonen CM6B	$\pm 40$ W/m <sup>2</sup>
$\Delta p$	Testo 435	$\pm 0.02$ hPa

### 3. Mathematical formulations

To analyse the heat removal intensification and the impact of this process on the PV roof tile working parameters, the fundamental calculations were conducted. Maximum generated power ( $P_{MPP}$ ) and maximum efficiency ( $\eta_{MPP}$ ) of the examined PV roof tile, for a given solar irradiance and the volumetric flow rate, were calculated from the following formulas:

$$P_{MPP} = V_{MPP} \cdot I_{MPP} \quad (1)$$

$$\eta_{MPP} = \frac{P_{MPP}}{G \cdot S} \quad (2)$$

where  $S$  was the active surface of the PV roof tile ( $S = 0.22 \text{ m}^2$ ).

Analysis of the parameters describing the heat transfer process began with the calculation of heat flux values ( $q$ ), which represented the possible amount of heat, obtained from cooling  $1 \text{ m}^2$  of the PV roof tile surface at a given intensity of solar irradiance and a given volumetric flow rate of air:

$$q = \frac{\rho_{air} \cdot \dot{V} \cdot c |_{T_{in}}^{T_{out}} \cdot (T_{out} - T_{in})}{M} \quad (3)$$

where  $M$  was the surface of one PV roof tile module ( $M = 0.29 \text{ m}^2$ ).

The thermal efficiency was calculated by the following formula:

$$\eta_{th} = \frac{q}{G} \quad (4)$$

The overall performance of the cooled PV roof tile, as an example of air based PVT collector was calculated as a sum of the electrical and the thermal efficiency [10,26]:

$$\eta_o = \eta_{MPP} + \eta_{th} \quad (5)$$

Additionally, according to literature [26], the total exergy efficiency ( $\eta_{Ex}$ ) of the cooled PV roof tile was calculated. It consisted of three types of exergy rates, ie. the total electrical exergy rate produced by the PV roof tile ( $Ex_{PV}$ ), the overall thermal exergy rate output ( $Ex_{th}$ ) and the exergy rate of solar radiation ( $Ex_{sun}$ ):

$$Ex_{PV} = \eta_{MPP} \cdot G \cdot A \quad (6)$$

where  $A$  was the air duct area ( $A = 0.25 \text{ m}^2$ );

$$Ex_{th} = \rho_{air} \cdot \dot{V} \cdot c |_{T_{in}}^{T_{out}} \cdot (T_{out} - T_{in}) \cdot \left(1 - \frac{T_{amb}}{T_{out}}\right) \quad (7)$$

where it was assumed, that the ambient temperature is the same as the cooling air inlet temperature;

$$Ex_{sun} = \left[1 + \frac{1}{3} \cdot \left(\frac{T_{amb}}{T_{sun}}\right)^4 - \frac{4 \cdot T_{amb}}{3 \cdot T_{sun}}\right] \cdot G \cdot A \quad (8)$$

where it was assumed that the Sun temperature  $T_{sun}$  was equal 3000 K (producer's data) – it was the monochromatic temperature of used halogen lamps. Taken into account all above mentioned components, the exergy efficiency can be defined as:

$$\eta_{Ex} = \frac{Ex_{PV} + Ex_{th}}{Ex_{sun}} \quad (9)$$



The final stage of the presented experimental studies was the analysis of measurement uncertainties. All measurements series were done in the steady state conditions. The number of measurements did not allow the statistical uncertainties analysis. The type A and B uncertainties components (according to GUM [27]) are based on the probability distributions and because of that, they cannot be applied for presented analysis, therefore the method of expanded uncertainties was used. Since the parameters, describing the operation of the PV roof tile, are combined quantities that were not measured directly, the uncertainty propagation law [27] was utilized to calculate the uncertainties. The calculations based on the directly measured quantities (e.g. voltage and current) and the measurement accuracies of the used devices and sensors, given by the manufacturers (Table 2). Generally, a formula for an uncertainty of determined quantity is given as:

$$u(y) = \sqrt{\sum_k \left[ \frac{\partial y}{\partial x_k} \cdot u(x_k) \right]^2} \quad (10)$$

The relative uncertainty of the determined quantity was calculated using the equation:

$$\delta_y = \frac{u(y)}{y} \cdot 100\% \quad (11)$$

## 4. Experimental results and discussion

This section presents the results of experimental research, together with an analysis of an impact of the air cooling and the air duct depth on the PV roof tile working parameters. The tests were carried out for the following cases:

- PV roof tile operation without cooling,
- cooling the back wall of the PV roof tile with air flowing in duct of 51 mm depth,
- cooling the back wall of the PV roof tile with air flowing in duct of 25 mm depth.

Three volumetric flow rates of cooling air were considered for each duct depth, namely 1, 2, and 4 m<sup>3</sup>/h. Measurements were conducted for the following solar irradiances: 300, 450, 600, 750, and 900 W/m<sup>2</sup>.

### 4.1. Temperature on the PV roof tile surface

In Fig. 4, the characteristics of average PV roof tile surface temperature as a function of the solar irradiance are plotted. The presented temperature values were calculated as the average of 9 measurements conducted in the places, marked in Fig. 2(a). During the study, it was observed, that the most significant drop of the average temperature (6.3 K) on the PV roof tile surface, in comparison with its temperature without cooling, was obtained for a duct with a depth of 25 mm and a volumetric flow rate of 4 m<sup>3</sup>/h. A smaller, but also a noticeable decrease (3.5 K) in the average temperature on the PV roof tile surface, was recorded for the duct with a depth of 51 mm at the same volumetric flow rate of air. Cooling the back wall of a PV roof tile with the air volumetric flow rate of 1 m<sup>3</sup>/h was the least effective in each case – the temperature on the PV roof tile surface, during cooling, was almost the same as its temperature without cooling. It is worth to mention, that during the experiment it was difficult to stabilize the ambient conditions. Based on this experience, in the future, a special attention should be devoted to analysis of the system behavior, at the low volume flow rates of the cooling air.

However, the temperature difference on the surface of the cooled PV roof tile depends on the place of its measurement. The largest drops, in comparison with the PV roof tile operation without cooling, were recorded on the PV tile surface, the closest to the cooling air inlet. The temperature increased with the direction of cooling air flow and reached its maximum on the PV cell surface, in the closest to the air outlet collector location. The highest heat removal took place in the lower part

of the PV roof tile. In the upper part, the temperature difference between the back wall and the heated air is too small, so the flowing air is not able to receive more heat. Table 3 presents the maximum temperature differences on the PV roof tile surface obtained during the tests. It is worth to add, that at a solar irradiance of  $900 \text{ W/m}^2$ , the temperature on the PV roof tile surface exceeded  $80 \text{ }^\circ\text{C}$  (maximum working temperature defined by the producer), and even reached  $90 \text{ }^\circ\text{C}$  in some parts of its surface.

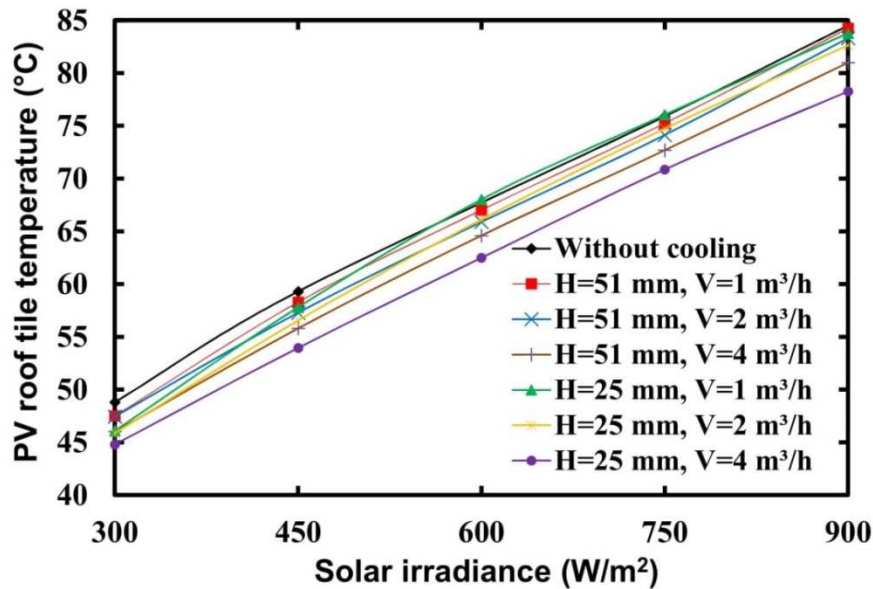

**Fig. 4.** The average PV roof tile surface temperature variation with the solar irradiance for the two duct depth and three volumetric flow rates of cooling air.

**Table 3**

The maximum temperature differences (K) on the PV roof tile surface.

Solar irradiance $\text{W/m}^2$	Without cooling	$H=51 \text{ mm}$ , $\dot{V}=1 \text{ m}^3/\text{h}$	$H=51 \text{ mm}$ , $\dot{V}=2 \text{ m}^3/\text{h}$	$H=51 \text{ mm}$ , $\dot{V}=4 \text{ m}^3/\text{h}$	$H=25 \text{ mm}$ , $\dot{V}=1 \text{ m}^3/\text{h}$	$H=25 \text{ mm}$ , $\dot{V}=2 \text{ m}^3/\text{h}$	$H=25 \text{ mm}$ , $\dot{V}=4 \text{ m}^3/\text{h}$
300	4.0	5.8	6.2	8.8	7.8	8.4	9.4
450	5.4	8.0	10.0	10.8	10.2	12.2	12.4
600	6.2	8.2	10.4	14.0	13.6	15.0	15.6
750	7.0	10.2	13.6	16.2	14.0	15.8	21.0
900	7.6	12.8	14.2	17.2	15.0	18.6	23.4

#### 4.2. Electrical parameters of the examined PV roof tile

The most crucial parameters, regarding PV roof tiles and other photovoltaic elements, are the generated electrical power and the efficiency of solar energy into electricity conversion. The graphs in Fig. 5 show the changes in generated electric power and electrical efficiency of the PV roof tile without and with cooling as a function of the solar irradiance. For each case, the generated electrical power increases with the increase of the solar irradiance. The characteristic curves are similar and overlap in some places. This situation is due to small changes in the generated power regardless of the used PV roof tile cooling parameters. The difference can be seen between non-cooled PV roof tile characteristic and the other graphs for the cooled PV roof tile. The largest increase in the generated power compared to uncooled PV roof tile, was 10.3 % and was obtained at the highest



solar irradiance ( $900 \text{ W/m}^2$ ) for the air volumetric flow rate of  $4 \text{ m}^3/\text{h}$  and a duct depth of  $25 \text{ mm}$ . The difference in the values is so small, that it falls within the range of measurement uncertainty. However, at irradiance lower than  $650 \text{ W/m}^2$ , the electrical power and efficiencies are higher for the PV roof tiles with larger ducts, but when the solar irradiance was higher than  $650 \text{ W/m}^2$ , then the electrical efficiencies and power are higher for the PV roof tiles with smaller ducts. Such tendency could refer to the higher velocity of the air in the channel of smaller height, what increases the convective heat transfer, and is more visible at higher values of solar irradiance. At its lower value and lower flow rates this difference is less visible than in the above mentioned cases. The presence of cooling affects the generated power and electrical efficiency, however the analyzed cooling conditions range gave similar results. Kasaeian et al. [19] also came to the same conclusions. Since the environmental conditions could influence the system behavior, the experimental stand should be isolated, to analyze pure cooling effect. This conclusion is very important and will be taken into consideration in the further analysis.

The generated electric power strongly affects the electrical efficiency of the examined PV roof tile. From the curves obtained during the tests, it can be concluded that the electrical efficiency change slightly at various cooling parameters. An improvement in electrical efficiency between the non-cooled and cooled PV roof tile is visible and its maximum reaches  $12.6 \%$  in comparison with its operation without cooling ( $H = 51 \text{ mm}$ ,  $\dot{V} = 1 \text{ m}^3/\text{h}$ ). The electrical efficiency increases until a solar irradiance equal to  $450 \text{ W/m}^2$  and then begins to decrease. The reason of this decrease may come from the high surface temperature of the PV roof tile at higher solar irradiance values. The presented efficiency values are relatively small, because of the experimental conditions. The solar light simulator generating solar irradiance, in the limited laboratory space, could be too close to the tested PV roof tile and heat it.

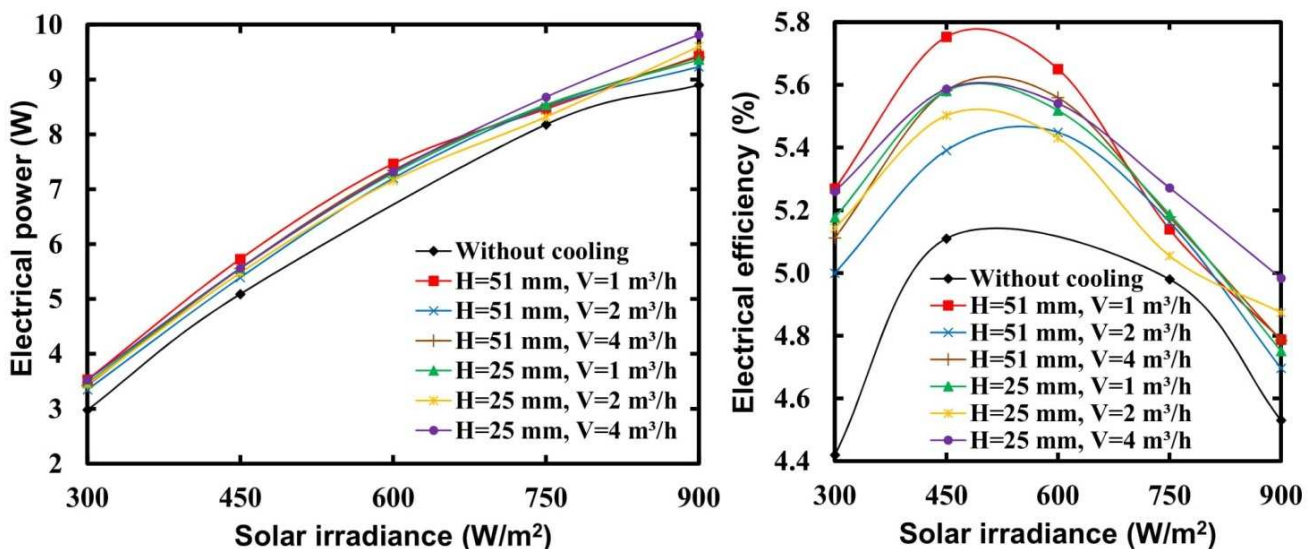

**Fig. 5.** Electrical characteristics of the PV roof tile as a function of the solar irradiance: (a) generated electrical power, (b) electrical efficiency.

#### 4.3. Thermal parameters of the examined PV roof tile

The primary aim of the presented research was to assess the possibility of heat recovery from the back wall of a PV roof tile, mainly in the basis of the cooling air inlet and outlet temperature values (Table 4). Since the PV roof tile heats up to the high temperature values, and possesses a free space between their back wall and the roof surface, there is a potential for such heat recovery.

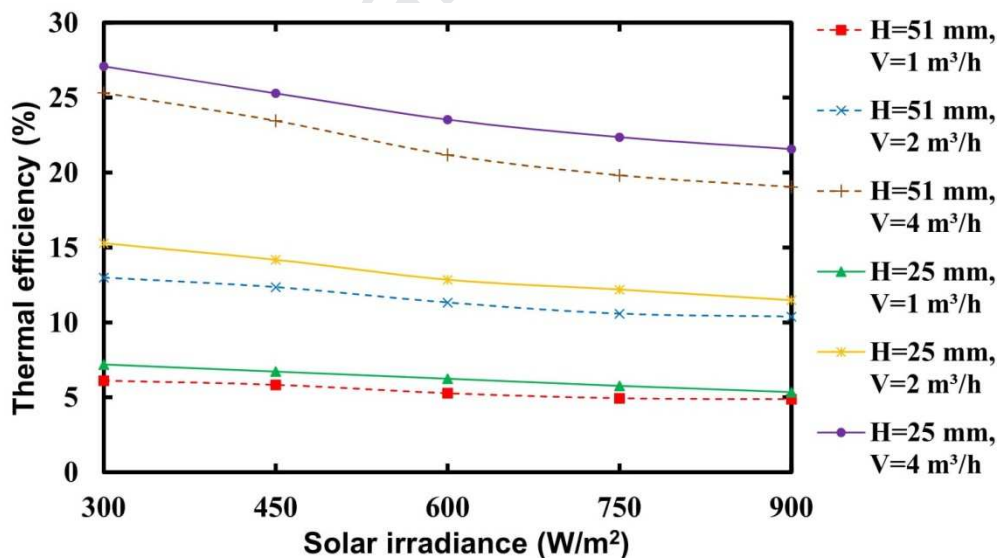

**Table 4**

Temperatures (°C) of the cooling air.

Solar irradiance $W/m^2$	$H=51$ mm, $\dot{V}=1$ m <sup>3</sup> /h		$H=51$ mm, $\dot{V}=2$ m <sup>3</sup> /h		$H=51$ mm, $\dot{V}=4$ m <sup>3</sup> /h		$H=25$ mm, $\dot{V}=1$ m <sup>3</sup> /h		$H=25$ mm, $\dot{V}=2$ m <sup>3</sup> /h		$H=25$ mm, $\dot{V}=4$ m <sup>3</sup> /h	
	$t_{in}$	$t_{out}$	$t_{in}$	$t_{out}$	$t_{in}$	$t_{out}$	$t_{in}$	$t_{out}$	$t_{in}$	$t_{out}$	$t_{in}$	$t_{out}$
300	26.0	43.9	25.0	43.1	24.3	42.5	24.0	45.2	24.4	46.5	24.6	44.7
450	28.2	54.1	27.3	53.4	26.1	51.6	26.6	56.7	26.3	57.4	26.1	54.5
600	29.8	61.3	28.6	60.8	27.9	58.9	28.6	66.6	28.0	66.0	27.3	62.9
750	31.6	68.9	28.5	66.7	29.1	65.7	30.1	75.3	29.6	75.3	28.6	71.4
900	31.1	75.2	30.1	75.5	30.1	72.6	32.1	82.4	31.4	83.7	29.7	79.8

Figure 6 presents the characteristics of thermal efficiency, determined for the examined PV roof tile. The thermal efficiency increases with the increase of the volumetric flow rate of cooling air. Reduction of the air duct depth has also a positive effect on the thermal performance, what agrees with the studies mentioned in Introduction [19-21]. The maximum thermal efficiency was about 27 % at the solar irradiance of 300  $W/m^2$ , the air volumetric flow rate of 4  $m^3/h$ , and the channel duct of 25 mm. With a twofold increase in the cooling air flow rate for a given duct depth, the thermal efficiency also increased by about 2 times. The thermal efficiency decreases with an increase in the radiation intensity. This decrease is due to the inability of receiving heat from the back wall of the PV roof tile by the flowing air, due to its high temperature. The temperature difference between the wall and the cooling air in the upper parts of the PV roof tile is too small. In such situation an improvement of the heat recovery requires an application of additional techniques, regarding passive heat transfer intensification, in example introduction of the turbulators.

**Fig. 6.** Thermal efficiency of the PV roof tile as a function of the solar irradiance.

During the experiment, an assessment of the amount of heat flux, which can be received during cooling 1  $m^2$  of roofing built of photovoltaic roof tiles was also done. Figure 7 shows the calculation results. Similarly to the thermal efficiency trend, doubling of the air volumetric flow rate leads to an approximately double increase in the heat flux. In addition, reduction of the duct depth, allows increase of the obtained heat flux by a maximum of 23  $W/m^2$  (at the solar irradiance of 900  $W/m^2$ ) in comparison with the duct of 51 mm depth. The use of air cooling, with the air volumetric flow rate of 4  $m^3/h$  and the duct depth of 25 mm, allows to increase the heat flux by 150  $W/m^2$  compared to the air cooling with the volumetric flow rate of 1  $m^3/h$  and the duct depth of 51 mm.



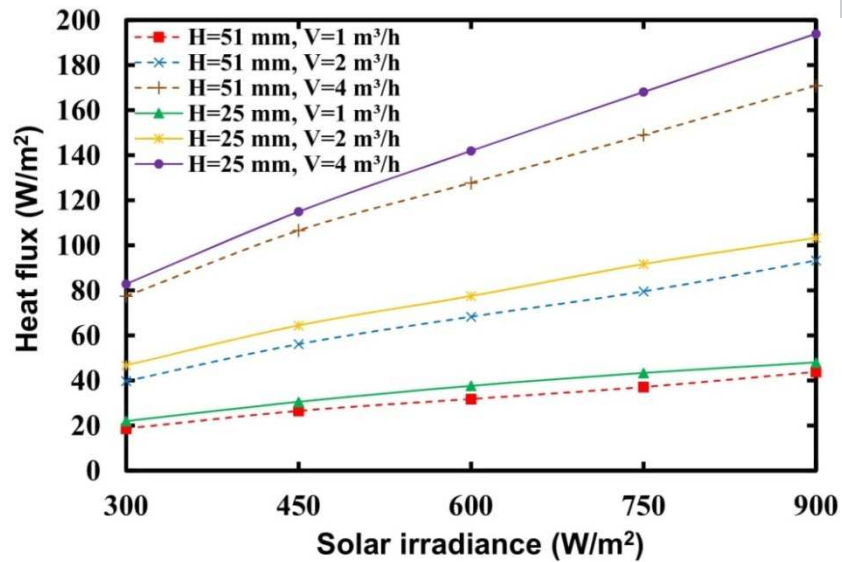

Fig. 7. Obtained heat flux values variation with the solar irradiance.

#### 4.4. Overall performance and a pressure drop during air cooling

After determining the efficiency of solar energy conversion into electricity and the thermal efficiency, depending on the cooling conditions, the assessment of the proposed system overall efficiency was conducted. Figure 8 shows the characteristics of the overall efficiency as a function of the solar irradiance. Due to the fact, that the overall efficiency strongly depends on the thermal efficiency, the trends of these characteristics are similar. The highest overall efficiency was obtained for cooling with the air volumetric flow rate of 4 m<sup>3</sup>/h and the duct depth of 25 mm – it was about 32 % at the solar irradiance of 300 W/m<sup>2</sup>. The overall efficiency decreases for the same reason as the thermal efficiency – there is too small temperature difference between the cooling air and the PV roof tile wall, therefore the heat transfer process occurs at the level, which is negligible. The selection of appropriate cooling parameters allowed to increase the overall efficiency of the presented system by 21%.

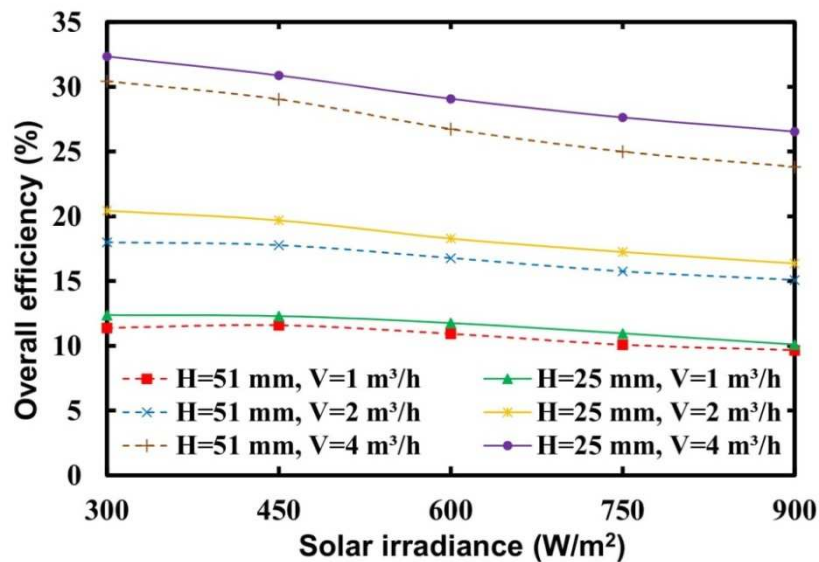

Fig. 8. The overall efficiency variation with the solar irradiance.

As it was mentioned in Section 2, the pressure drop in the PV roof tile casing was also measured during the experiment – it was caused by the cooling air flow resistance. The highest flow resistance was generated during cooling with an air volumetric flow rate of 4 m<sup>3</sup>/h and a duct depth of 25 mm. These resistances extended the residence time of the cooling air in the casing, so that it could gain more heat (see Fig. 9).



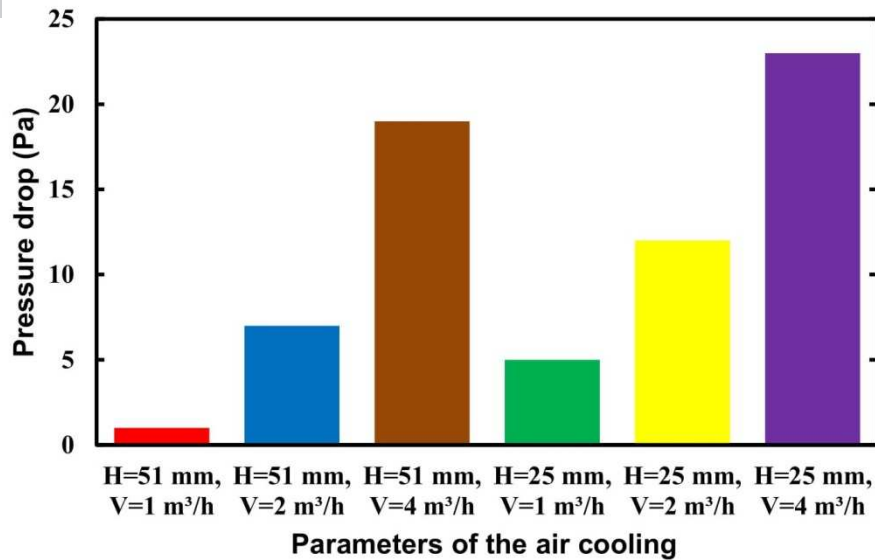

Fig. 9. Dependence of the pressure drop on cooling parameters.

#### 4.5. Exergy analysis

The next stage of the research was connected with an exergy analysis of the presented system. Exergy efficiency ( $\eta_{Ex}$ ) is based on the second law of thermodynamics and allows analysis of the systems in terms of energy transformation quality. The total electrical exergy rate produced by the PV roof tile ( $Ex_{PV}$ ), the overall thermal exergy rate output ( $Ex_{th}$ ) and the exergy rate of solar radiation ( $Ex_{sun}$ ) were calculated based on Equations (6-9). The obtained results are summarized in Table 5. The maximum exergy efficiency, depending on the cooling conditions, ranged from 5.08 to 9.94 % and was the highest for cooling with the air volumetric flow rate of 4 m<sup>3</sup>/h and a duct depth of 25 mm. These values are in the range reported by Akpinar and Kocycigit [28], who for similar geometry of the solar air heater obtained exergy efficiency between 8.32 and 44 %.

**Table 5**

Calculation results of electrical, thermal and solar radiation exergy rates and exergy efficiency

	Solar irradiance	Without cooling	H=51 mm, $\dot{V}=1$ m <sup>3</sup> /h	H=51 mm, $\dot{V}=2$ m <sup>3</sup> /h	H=51 mm, $\dot{V}=4$ m <sup>3</sup> /h	H=25 mm, $\dot{V}=1$ m <sup>3</sup> /h	H=25 mm, $\dot{V}=2$ m <sup>3</sup> /h	H=25 mm, $\dot{V}=4$ m <sup>3</sup> /h
$Ex_{sun}$ [W]	300	64.3	64.1	64.1	64.2	64.2	64.2	64.1
	450	96.4	96.0	96.1	96.1	96.1	96.1	96.1
	600	128.6	127.9	128.0	128.1	128.0	128.1	128.1
	750	160.7	159.8	160.7	160.0	159.9	160.0	160.0
	900	192.8	192.8	192.8	191.9	191.7	191.8	191.9
$Ex_{PV}$ [W]	300	3.3	3.9	3.7	3.8	3.8	3.8	3.9
	450	5.7	6.4	6.0	6.2	6.2	6.1	6.2
	600	7.6	8.4	8.1	8.2	8.2	8.0	8.2
	750	9.2	9.5	9.5	9.6	9.6	9.3	9.7
	900	10.0	10.6	10.4	10.6	10.5	10.8	11.1
$Ex_{th}$ [W]	300	-	0.3	0.7	1.3	0.4	0.9	1.5
	450	-	0.6	1.3	2.4	0.8	1.8	2.9
	600	-	0.9	1.9	3.5	1.2	2.5	4.4
	750	-	1.2	2.6	4.7	1.6	3.5	6.1
	900	-	1.6	3.5	6.1	2.0	4.4	8.0

	Solar irradiance	Without cooling	$H=51$ mm, $\dot{V}=1$ m <sup>3</sup> /h	$H=51$ mm, $\dot{V}=2$ m <sup>3</sup> /h	$H=51$ mm, $\dot{V}=4$ m <sup>3</sup> /h	$H=25$ mm, $\dot{V}=1$ m <sup>3</sup> /h	$H=25$ mm, $\dot{V}=2$ m <sup>3</sup> /h	$H=25$ mm, $\dot{V}=4$ m <sup>3</sup> /h
$\eta_{Ex}$ [%]	300	5.08	6.56	6.80	7.92	6.63	7.40	8.45
	450	5.88	7.28	7.58	8.98	7.28	8.19	9.47
	600	5.94	7.21	7.79	9.13	7.33	8.25	9.82
	750	5.73	6.68	7.56	8.92	7.02	8.03	9.89
	900	5.21	6.35	7.24	8.72	6.53	7.94	9.94

#### 4.6. Analysis of the measurements uncertainties

The uncertainty analysis was carried out in accordance with Equations (10) and (11). The list of the uncertainty maximum values, specified for the electrical and thermal parameters discussed in the work, is presented in Table 6. A special attention was paid to obtaining the same solar irradiance for each measurement series (at all cooling conditions and its absence). It was controlled by a solarimeter (shown in Fig. 2(a)). Its accuracy (listed in Table 2) was taken into account during the uncertainties calculations of the electrical and thermal efficiencies. The solar light simulator consisted of the same bulbs, with the same color temperature. During the tests, its position, as well as its distance in relation to the PV roof tile, were not changed, therefore it was assumed that the PV roof tile had the same solar conditions.

**Table 6**

Maximal uncertainties values.

Parameter	Relative value [%]
Generated electrical power	12.00
Electrical efficiency	0.25
Heat flux	10.54
Thermal efficiency	0.13
Overall efficiency	0.19

#### 4.7. Discussion and future plans

The presented results of experimental investigations, conducted on a commercial PV roof tile, indicate, that there is a potential for the development of further research towards improving the intensification of heat removal from its back wall. It is necessary to take into account the restrictions – among other a small distance between the PV roof tile and the roof surface, as well as the availability of the cooling medium. Air seems to be a legitimate medium when considering hot-climate countries with limited water resources. Also, in highly sunny areas, there is a very high probability, that the PV roof tile will heat to a temperature exceeding the permissible temperature of its work, which may damage it.

The test results clearly show, that an increase in the cooling air volumetric flow rate and a decrease in the duct depth, in which the air flows, have a positive effect on the amount of heat removed from the back wall of the PV roof tile. The impact of cooling on the generated electric power and the efficiency of solar energy conversion into electricity was noticed. During further considerations, the effect of ambient conditions also should be excluded as much as possible. It will enable assessment of the impact of cooling on the increase of the PV roof tile electrical efficiency and the generated power.

The achieved thermal efficiency values indicate, that with the increase of solar radiation intensity and the increasing potential of heat transfer, the possibilities of heat removing from the wall of the PV roof tile are limited due to the insufficient temperature difference between the cooling medium and the hot element. Therefore, it should be investigated, at which cooling air volumetric flow rate and a duct height the heat recovery will be the highest. In addition, the flow



geometry should be adequately planned to cool the PV roof tile evenly over its entire surface despite the constantly heating medium. It requires numerical simulations to verify which solution meets the condition in the best manner.

## 5. Conclusions

The article discusses the results of research using the photovoltaic roof tile, which is in-line with the BIPV technology. It has been proven that the depth of the cooling duct and the air volumetric flow rate have a crucial impact on the obtained results. A smaller channel depth (25 mm) and a larger volumetric flow rate of cooling air (4 m<sup>3</sup>/h) caused the most visible heat removal from the PV roof tile. The air cooling of the back wall of the PV roof tile allowed the average surface temperature to be lowered by a maximum of 6.3 K, while the temperature difference between the surface next to the cooling air inlet and the surface next to its outlet was a maximum of 23.4 K. Both values were obtained for cooling by air with the volumetric flow rate equal to 4 m<sup>3</sup>/h and the channel depth of 25 mm, at the solar irradiance of 900 W/m<sup>2</sup>. For these parameters, the highest value of generated power (9.82 W) and heat flux value (about 194 W/m<sup>2</sup>) were also obtained, as well as flow resistance, which amounted to 23 Pa. In turn, at the same cooling parameters, but at the solar irradiance of 300 W/m<sup>2</sup>, the highest thermal efficiency (27 %) and overall efficiency (about 32 %) were obtained. An exergy analysis was performed, achieving an exergy efficiency between 5.08 % and 9.94 %.

Since the need of cooling the elements made of monocrystalline silicon, from which the presented PV roof tile is also built, the authors in their further studies will focus on improving the process of heat transfer from a hot wall element. The further experimental studies, supported by the preceding numerical simulations, will be performed. Also, the use of recovered heat is considered for other purposes, for example, ventilation or as a heat pump's lower source. The construction of an installation consisting of several PV roof tiles to verify the profitability of different methods is also in the plans. The presented results were obtained during the PV roof tile operation under the influence of light falling on it, generated by a solar light simulator. The use of such a simulator has the main advantage of being able to set the appropriate solar irradiance and keeping this value constant during the measurement series. It allows comparison of the results obtained at various cooling conditions. However, the amount of heat generated by halogen lights, which are near the PV roof tile, can be much higher than the amount of heat generated by the sun. Therefore, the measurements at the natural conditions should be conducted and then compared with the laboratory cases.

## Nomenclature

$A$	air duct area, m <sup>2</sup>
$c$	air specific heat, J/kgK
$Ex$	exergy rate, W
$G$	solar irradiance, W/m <sup>2</sup>
$H$	height of the air duct, mm
$I$	electrical current, A
$M$	the surface of one PV roof tile module, m <sup>2</sup>
$P$	electrical power, W
$q$	heat flux, W/m <sup>2</sup>
$R$	electrical resistance, $\Omega$
$S$	the PV roof tile active surface area, m <sup>2</sup>
$T$	temperature, K
$V$	voltage, V
$\dot{V}$	volumetric flow rate, m <sup>3</sup> /h

*Greek symbols*



$\Delta p$	pressure drop, Pa
$\eta$	efficiency, %
$\rho$	air density, kg/m <sup>3</sup>

### Subscripts

air	air
amb	ambient
in	inlet
MPP	maximum power point
o	overall
out	outlet
PV	photovoltaic
sun	sun
th	thermal

## References

- [1] Moomaw W, Yamba F, Kamimoto M, Maurice L, Nyboer J, Urama K, Weir T: 2011 Introduction. In IPCC Special Report on Renewable Energy Sources and Climate Change Mitigation [O. Edenhofer, R. Pichs-Madruga, Y. Sokona, K. Seyboth, P. Matschoss, S. Kadner, T. Zwickel, P. Eickemeier, G. Hansen, S. Schlömer, C.von Stechow (eds)], Cambridge University Press, Cambridge, United Kingdom and New York, NY, USA.
- [2] United Nations, Framework Convention on Climate Change (FCCC). Report of the Conf. of the Parties on its twenty-first session, held in Paris from 30 November to 13 December 2015. <https://unfccc.int/resource/docs/2015/cop21/eng/10a01.pdf>.
- [3] Foster R, Ghassemi M, Cota A. Solar Energy: Renewable Energy and Environment. Taylor & Francis Group, LLC 2010; p. 4.
- [4] Chander S, Purohit A, Sharma A, Arvind, Nehra SP, Dhaka MS. A study on photovoltaic parameters of mono-crystalline silicon solar cell with cell temperature. Energy Reports 2015;1:104–109.
- [5] Kalogirou SA, Tripanagnostopoulos Y. Hybrid PV/T solar systems for domestic hot water and electricity production. Energy Conversion and Management 2006;47(18-19):3368–82.
- [6] International Partnership for Energy Efficiency Cooperation (IPEEC). Zero energy building definitions and policy activity. An international review. 2018. [https://ipeec.org/upload/publication\\_related\\_language/pdf/766.pdf](https://ipeec.org/upload/publication_related_language/pdf/766.pdf). [Accessed 20 October 2019].
- [7] Debbarma M, Sudhakar K, Baredar P. Comparison of BIPV and BIPVT: A review. Resource-Efficient Technologies 2017;3(3):263–271.
- [8] Dubey S, Sarvaiya JN, Seshadri B. Temperature dependent photovoltaic (PV) efficiency and its effect on PV production in the world – A review. Energy Procedia 2013;33:311–321.
- [9] Sato D, Yamada N. Review of photovoltaic module cooling methods and performance evaluation of the radiative cooling method. Renewable and Sustainable Energy Reviews 2019;104:151–166.
- [10] Al Waeli AHA, Sopian K, Kazem HA, Chaichan MT. Photovoltaic/Thermal (PV/T) systems: Status and future prospects. Renewable and Sustainable Energy Reviews 2017;77:109–130.
- [11] Siecker J, Kusakana K, Numbi BP. A review of solar photovoltaic systems cooling technologies. Renewable and Sustainable Energy Reviews 2017;79:192–203.
- [12] Zubeer SA, Mohammed HA, Ilkan M. A review of photovoltaic cells cooling techniques. E3S Web of Conferences. International Conference on Advances in Energy Systems and



Environmental Engineering (ASEE17), Wrocław, Poland, 2–5 July 2017; 2017;22:00205.

- [13] Wajs J, Golabek A, Bochniak R. Photovoltaic roof tiles: The influence of heat recovery on overall performance. *Energies* 2019;12:4097.
- [14] Shahsavari A, Salmanzadeh M, Ameri M, Talebizadeh P. Energy saving in buildings by using the exhaust and ventilation air for cooling of photovoltaic panels. *Energy and Buildings* 2011;43:2219–2226.
- [15] Ahmed-Dahmane M, Malek A, Zitoun T. Design and analysis of a BIPV/T system with two applications controlled by an air handling unit. *Energy Conversion and Management* 2018;175:49–66.
- [16] Kim JH, Park SH, Kim JT. Experimental performance of a photovoltaic-thermal air collector. *Energy Procedia* 2014;48:888–894.
- [17] Amelia AR, Irwan YM, Irwanto M, Leow WZ, Gomesh N, Safwati I, Anuar MAM. Cooling on photovoltaic panel using forced air convection induced by DC fan. *International Journal of Electrical and Computer Engineering* 2016;6(2):526–534.
- [18] Bambrook SM, Sproul AB. Maximising the energy output of a PVT air system. *Solar energy* 2012;86:1857–1871.
- [19] Kasaeian A, Khanjari Y, Golzari S, Mahian O, Wongwises S. Effects of forced convection on the performance of a photovoltaic thermal system: An experimental study. *Experimental Thermal and Fluid Science* 2017;85:13–21.
- [20] Pauly L, Rekha L, Vazhappilly CV, Melvinraj CR. Numerical Simulation for Solar Hybrid Photovoltaic Thermal Air Collector. *Procedia Technology* 2016;24:513–522.
- [21] Abdullah AL, Misha S, Tamaldin N, Rosli MAM, Sachit FA. Numerical analysis of solar hybrid photovoltaic thermal air collector simulation by ANSYS. *CFD Letters* 2019;11(2):1–11.
- [22] Kaiser AS, Zamora B, Mazón R, García JR, Vera F. Experimental study of cooling BIPV modules by forced convection in the air channel. *Applied Energy* 2014;135:88–97.
- [23] Touafek K, Khelifa A, Haloui H, El Hocine HBC, Boutina L, Baissi MT, Malek A, Haddad S, Tabet I. Improvement of performances of solar photovoltaic/thermal air collector in South Algeria. 2018. <https://doi.org/10.1109/irsec.2018.8702971>.
- [24] Producer data, SolteQ Europe GmbH, Catalog SolteQ Solarroofs. <http://www.solteq.eu/SolteQ-Catalog-Solarroofs.pdf>. [Accessed 25 October 2019].
- [25] Ratajczak J. The Issues of Spectrally-Thermal Simulation of Solar Radiation. Ph.D. Thesis, Poznan University of Technology, Poznan, Poland, 2013.
- [26] Wu SY, Wang T, Xiao L, Shen ZG. Effect of cooling channel position on heat transfer characteristics and thermoelectric performance of air-cooled PV/T system. *Solar Energy* 2019;180:489–500.
- [27] Working Group 1 of the Joint Committee for Guides in Metrology. Evaluation of measurement data: Guide to the Expression of uncertainty in measurement. JCGM; 2008. [https://www.bipm.org/utls/common/documents/jcgm/CGM\\_100\\_2008\\_E.pdf](https://www.bipm.org/utls/common/documents/jcgm/CGM_100_2008_E.pdf). [Accessed 20 November 2019].
- [28] Akpınar EK, Kocuyigit F. Energy and exergy analysis of a new flat-plate solar air heater having different obstacles on absorber plates. *Applied Energy* 2010;87:3438–50.

