

XVI Seminarium
ZASTOSOWANIE KOMPUTERÓW W NAUCE I TECHNICIE' 2006
Oddział Gdański PTETiS
Referat nr 9

ANALYSIS OF NONLINEAR EFFECTS AS A DIAGNOSTIC TOOL

Lech HASSE¹, Josef ŠIKULA², Martin BLAHA³

1. Gdańsk University of Technology, Faculty of Electronics, Telecommunication and Informatics, Department of Optoelectronics and Electronic Systems
tel: +48 58 347-1884 fax: +48 58 341-6132 e-mail: lhasse@pg.gda.pl
2. Brno University of Technology, Faculty of Electrical Engineering and Communications, Czech Noise Research Laboratory (CNRL)
tel: +420 541-143328 fax: +420 541-143398 e-mail: sikula@feec.vutbr.cz
2. Brno University of Technology, Faculty of Electrical Engineering and Communications, Department of Physics
tel: +420 54114 3258 fax: +420 54114 3258 e-mail: xblaha10@stud.feec.vutbr.cz

Methods of nonlinear effects analysis at the output signal of tested objects give the possibility of defects and damage examination in materials and electronic devices what is useful in reliability prediction. For passive elements a very effective tool exemplifies Third Harmonic Index (THI). The THI measurements for interference suppressor capacitors and its properties have been described in detail. The application of bispectrum in analysis of resistance fluctuations in gas sensors was briefly presented. Advantages of nonlinear spectroscopy in non-destructive testing of objects have also been pointed out.

1. INTRODUCTION

A behavior of nonlinear systems is not expressible as a sum of the behaviors of its descriptors and is not subject to the principle of superposition. Therefore it is often difficult to model them, and their behavior with respect to a given variable (for example, time) is extremely difficult to predict. Nonlinearity is the behavior of a circuit, in which the output signal amplitude does not vary in direct proportion to the input signal amplitude. In a nonlinear device, the output-to-input amplitude ratio depends on the level of the input signal.

Nonlinearity and noise measurements used for analysis, diagnostics and prediction of reliability of electronic devices have been presented in many papers. Reliability Physics is devoted to identification of failure modes and mechanisms related to quality assessment and reliability prediction. Generally it is assumed that reliability is determined by irreversible processes and the analysis of their time dependence represents a main tool for

device lifetime prediction. A nonlinearity of resistivity and the noise of tested objects can give a basis for solving the problem.

Nonlinearity for two-terminal electronic devices is an unwanted feature of linear (passive) components caused by nonlinear areas within the bulk of these elements or a desired (useful) feature of some semiconductor devices. It manifests itself in a change in the component impedance dependently on the level of biasing or in a change in the time, expressed as a voltage versus current relationship in the time domain.

Quality and endurance tests are required, for example, for all produced interference suppressor capacitors during their manufacturing. Such tests are carried out mainly using destructive and long-lasting environmental (endurance) trials for selected samples. The problem can be solved by implementation into the production testing system some direct nonlinearity measurement tasks.

2. NONLINEARITY OF TWO-TERMINAL DEVICES

It has been proved experimentally that passive components showing high nonlinearity are less stable and have shorter lifetime. The dependence between reliability and nonlinearity is similar as between noise and reliability, therefore the level of nonlinearity can be used as a measure of long term reliability (endurance) for a tested element [1].

Accomplished production investigations enables to state that the increased level of nonlinearity in capacitors is mainly caused by instability of contacts, improper adhesion (flicker of capacitance about 0.001% of a mean value), electrodes and dielectric heterogeneity, weak contact between an electrode and a terminal, ferric oxide existence in dielectric particles, slow processes of insulating layer degradation, inhomogeneities and microcracks of foil and silver migration in foil capacitors, dielectric aging, improper terminal construction, mechanical instability of a capacitor. In tested foil capacitors (with plastic film dielectric) nonlinearities can be related to terminals or plates of a capacitor and to a dielectric (e.g. gas bubbles as defects). In such a way it is possible to select the capacitors with higher level of reliability by means of nonlinearity measurement. The determination in production process of the statistics for the third harmonic index enables the improvement of a production technology.

In practice, for resistors and capacitors (ceramic, tantalum, niobium, solid aluminum or foil) the tests rely on the measurement of nonlinearity for nominally linear parameters. A nonlinearity is measured by stimulation of a tested passive element by the pure harmonic signal and a selective measurement at the output the signal component having frequency equal the third harmonic of the stimulating voltage. It can be expressed (in decibels) as a ratio of the voltage of third harmonic (TH) to the voltage of applied sinusoidal signal. It was found that only a TH has a non-negligible level and higher harmonics have not to be taken into account. A residual nonlinearity of a measurement system should be assumed as no higher than -140 dB (-120 dB can be established as an acceptance level).

Nonlinearity measurements consist in determining the deviation from linear V-I characteristics. Therefore the TH is proportional to the extent of elementary nonlinearity. It comprises a built-in component (its level is to be considered as a mean value of nonlinearity), excessive component (due to a high contact resistance of any junction affecting the $U-I$ curve, physical properties of the base material, defects and inhomogeneities in the material structure or interaction with the environment; equal zero at no defect present) and capacitor instability in time. If the first harmonic amplitude increases, the

response of the modulated signal will grow allowing distinguishing the built-in from the unwanted nonlinearity components.

The nonlinearity of capacitor under test was determined by a measurement of TH (30 kHz) generated by a capacitor when a 10 kHz signal is applied to it (Fig.1). The voltage source U_{3f_0} represents the nonlinear effect of the signal U_{f_0} processed in the tested capacitor. The level of TH component is chosen as a measure of the nonlinearity of the capacitor C_x .

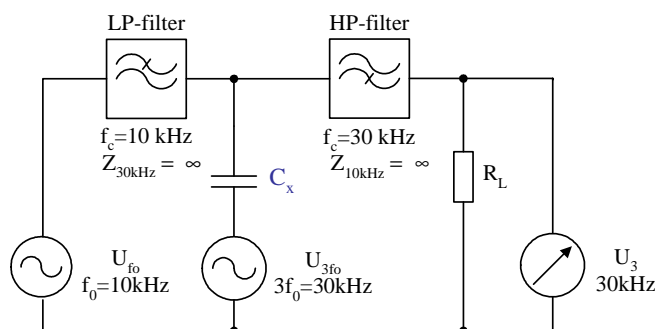

Fig. 1. Simplified equivalent diagram of the TH measurement system

Nonlinearities and TH fluctuations of interference suppression capacitors designed to attenuate the radio frequency interferences generated by household equipment and conducted to supply network - WXPC 0.068 μF , 0.1 μF , 0.22 μF , 0.33 μF and 0.68 μF produced by MIFLEX [2] were measured. They have been produced using a 7.5 μm thickness and 13.5 or 21 mm width polypropylene foil with a 2 mm margin. The dielectric constant and resistivity of metallic layer are equal $\epsilon = 2.2$ and $r = 7.5 \Omega / \pm 30\%$, respectively. The TH level of several batches of capacitor samples (100 pieces each) was measured using Component Linearity Test Equipment LCT 10 (Danbridge) and LTC 1020 Device Linearity Tester (VS Technology). The special construction matching transformer with minimization of residual nonlinearity and five ranges of transformation assures a matching of the generator and the selective voltmeter in a wide range of passive component impedances. If the first harmonic amplitude increases, the response of the modulated signal will grow allowing to distinguish the built-in from the unwanted nonlinearity components. It also gives a possibility an evaluation of nonlinearity variations in the time domain. It enables to detect poor contacts between foil and lead-in wire, defects in dielectrics and evaluate the quality of a base material.

The foil capacitors normally exhibits low distortion, therefore reliability testing by means of the TH measurement can be carried out with success. It can be proved that TH is dependent on the signal rms value by the third order and on the second order of the foil thickness. Therefore the dependence of the foil thickness is a good tool to find capacitors with weak spots. In case of polystyrene capacitors the utmost stability is required and it is fulfilled at the TH measurement [3].

The TH distortion is proportional to the m^{th} order of the applied voltage U_1 . Experimentally measured mean values of the exponent m are equal 1.75 to 2.1 for measured capacitors (Fig. 2), taking into account the mean value of the TH for all measured capacitors in the sample at the different voltage of stimulating harmonic signal $U_1[\text{V}]$.

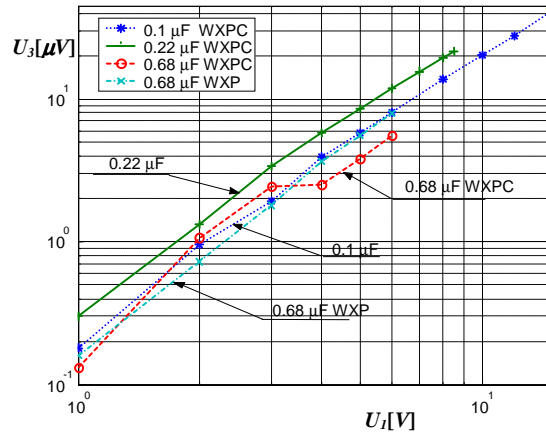

Fig. 2. $U_{3h}[\mu V]$ versus applied $U_1[V]$ (log-log scale) for several type of MIFLEX capacitors

Standard endurance test are performed in the test chamber. Class X capacitors are submitted to an endurance test of 1000h at upper category temperature and with 1.25 Voltage Rating (once every hour the voltage is increased to $1000 V_{rms}$ for 0.1s). After such a trial the mean value of m parameter increases slightly for the 0.22 μF capacitors (Fig. 3).

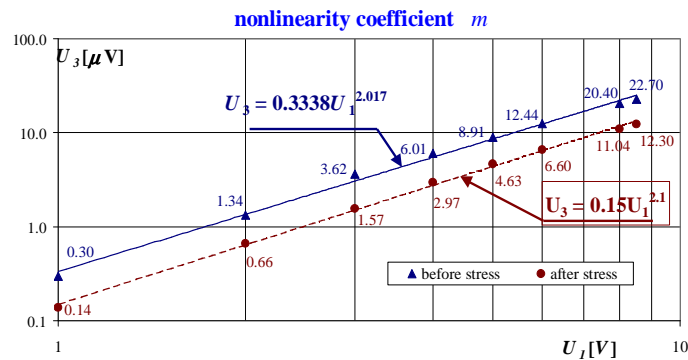

Fig. 3. The change of the U_{3h} slope versus applied $U_1[V]$ (log-log scale) after the endurance test

The TH value of components (stemming from the same batch) with nominally the same impedance should have the Gaussian distribution around the mean value. However, usually a few of components exhibit a higher level of TH due to defects or deviations in material composition. The shape of the TH distribution is very important as a basis for the criterion of capacitors classification on the reliability classes. Exposing the batch to an accelerated life trial, the components having a higher value of TH will also be prone to exhibit inferior reliability. However, high-dielectric capacitors have sometimes excessive TH from a small defect hidden in the high inherent distortion which cannot be easily detected. In such cases it is used to plot the TH values on a special probability chart. The actual value of TH in a good component should be found experimentally.

After the 1000h endurance test the capacitance and the TH values were measured for all the batches under test. The mean value of capacitance C in the sample was lowered after

the test and the shape of the C distribution was changed. The changes of TH distribution for the same capacitors after the endurance test are shown in the Figure 4 [4]. The mean value of the TH was decreased twice whereas the TH distribution became more wide.

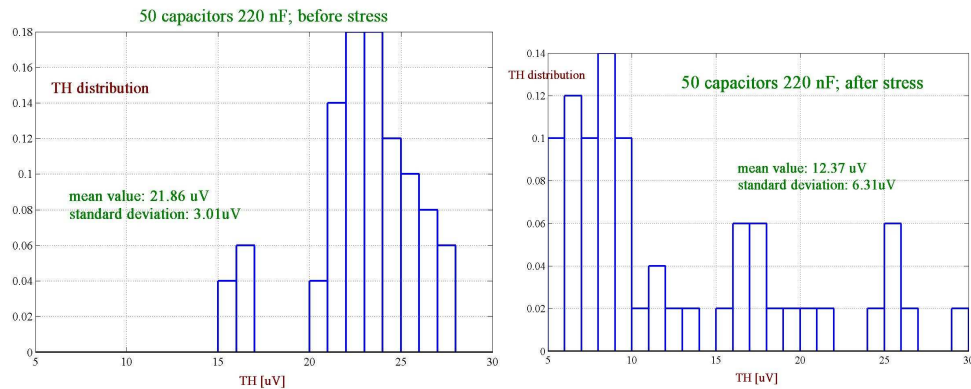

Fig. 4. TH distribution in the sample of 50 capacitors 220nF before and after the 1000h endurance test

Generally, the capacitance after stress was decreased not more than 2% and the spread of C value remained at the same level. However the mean value of TH lowered about almost 50% but the standard deviation increased more than two times. One can expect that the capacitors having higher value of TH after such a trial are potentially more unreliable.

The mean value of the TH in the sample depends on the capacitance – the higher value of a capacitance the greater mean value of the TH distribution (simplified diagram of this dependence taken experimentally is shown in the Figure 5).

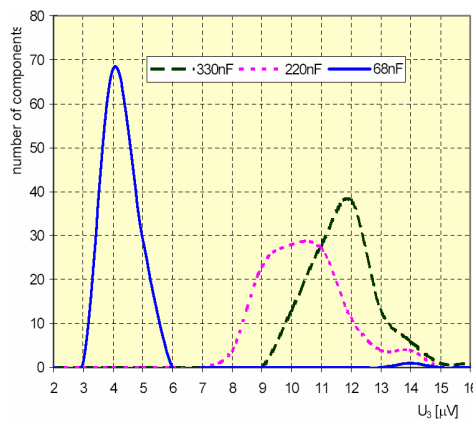

Fig. 5. Distribution of the TH for selected batches (100 pieces each) of MIFLEX foil capacitors

The main part of an every curve represents the range of built-in non linearity adequate for good quality devices. On the left side of these areas we have a range corresponding to none or minimal non linearity whereas on the right side is the range of unwanted, excessive nonlinearity referring to the capacitors with lower level of reliability. The TH index is dependent on the capacitance of tested interference suppressor capacitors.

3. NONLINEARITY OF FLUCTUATION PHENOMENA IN GAS SENSORS

In resistive gas sensors the stochastic signal component $x(t)$ can be treated as a source of information that can significantly improve the sensitivity and selectivity of gas sensors [6]. The stochastic component of chemical sensor signal contains valuable information that can be visualized not only by spectral analysis but also by using nonlinear characteristic components. A strong non-Gaussian component is expected only in gas sensors with small volume or inhomogeneous current density, however non-Gaussian components can occur even in commercial Taguchi sensors because of their strongly inhomogeneous structure.

The general block diagram of the portable electronic system for gas detection by noise measurement is shown in Figure 6 [5]. A gas sensor having resistance R_s is biased by the battery and heated by the additional DC voltage source. The sampled noise data have non-gaussian components corresponding to different kind of detected gases.

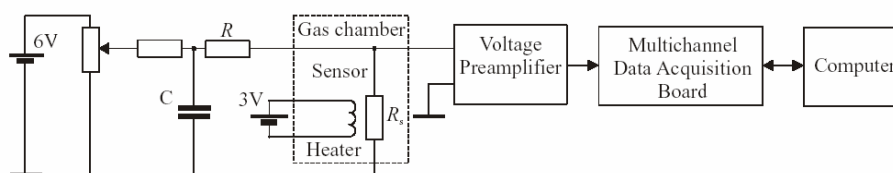

Fig. 6. Circuit of single gas sensor biasing and one channel of noise measurement system

The inhomogeneous and porous sensor structure can be a source of different fluctuation phenomena that can be used for enhanced gas selectivity. The resistance noise spectrum is often used as a sensitive measure of the chemical environment.

A more useful characteristic can be obtained from the bispectrum function defined as the second-order Fourier transform of the third-order cumulant of the noise signal. The bispectrum is a statistic used to search for nonlinear interactions. The Fourier transform of the second-order cumulant, i.e., the autocorrelation function, is the traditional power spectrum. The Fourier transform of $C_3(t_1, t_2)$ (third-order cumulant-generating function) is called the bispectrum or bispectral density. They fall in the category of *higher-order spectra*, or *polyspectra* and provide supplementary information to the power spectrum.

The third order polyspectrum (bispectrum) is the easiest to compute, and hence the most popular. Its values are non-zero only for the case of non-Gaussian noise. The bispectra shown in the Figure 7 are rather relatively small for a limited range of low frequencies and it suggests that the tests of Gaussianity and linearity do not reject a Gaussian hypothesis. Very different shapes of the bispectrum function are observed for the different vapors. It is evident that the small, but characteristic, values of the bispectrum functions for different vapors give useful information for identifying odors.

The bispectrum image in the form of cross-level plot (Fig. 8) giving more information than the power spectrum can be treated as an enhanced pattern for gas detection and recognition. This technique is suggested as a more important for the nanoparticle gas sensors having tiny and non-homogenous structures.

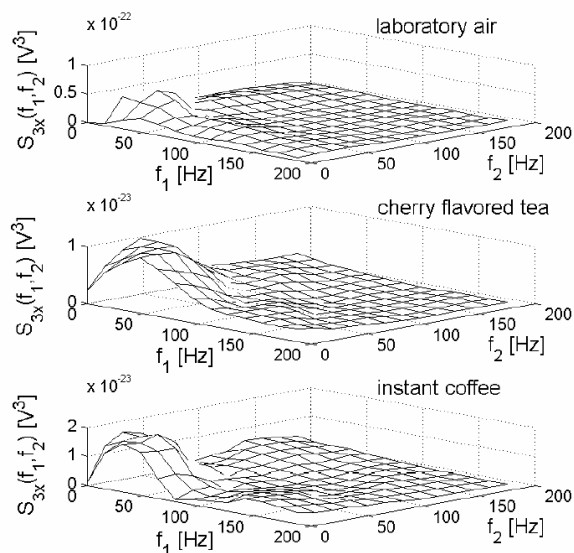

Fig. 7. Bispectrum function calculated for the recorded voltage noise samples of the sensor exposed to different natural vapors.

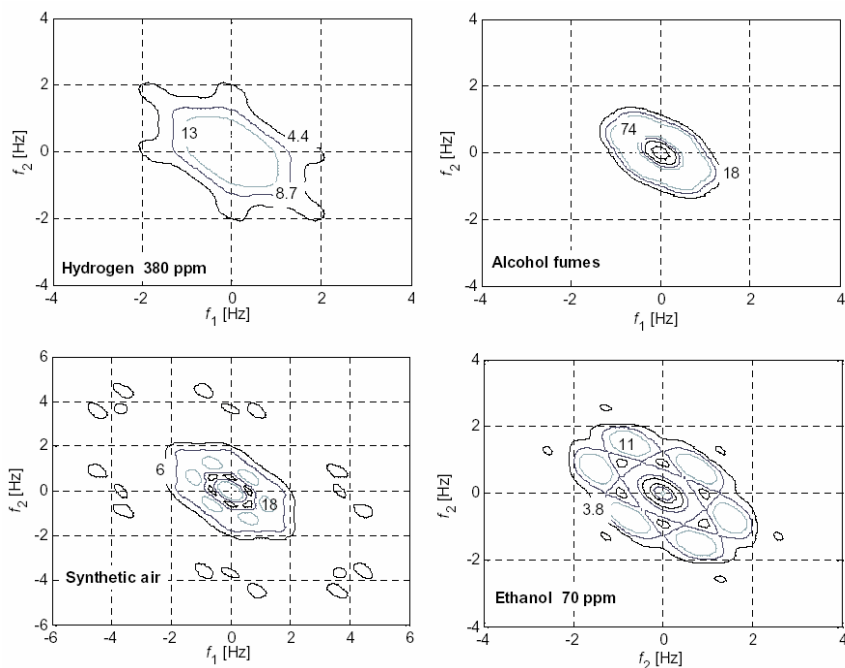

Fig. 8. Bispectrum functions for the CO sensor at the sampling frequency $f_s = 100$ Hz [6]

Useful information about detected gases can give also more complex function such as an integrated bispectrum and trispectrum [6].



4. NONLINEAR SPECTROSCOPY AS NON-DESTRUCTIVE TESTING TOOL

The nonlinearity due to the presence of the cracks in the measured components is an extremely sensitive indicator of the presence of component's damage [7]. The damaged portion of the material acts as a nonlinear mixer (multiplier). Nonlinear influence of crack to ultrasound wave propagation is very sensitive indicator of this defect, because undamaged material has practically zero nonlinear influence. Using a frequency spectrum analysis it is quite easy to show the difference between an undamaged and damaged object.

A new principle of non-destructive testing of conducting solids is based on nonlinear effects created by nonharmonic motion of atoms subjected to ultrasonic wave motion [8]. Physical principle is based on ultrasonic phonons interaction with electrons on defect nonlinearity. Tested sample is excited by harmonic AC electrical signal with frequency f_E and ultrasonic wave with frequency f_U . On the defect nonlinearity new harmonic signal is created with frequency f_0 given by superposition or subtraction of excited frequencies f_E and f_U . This signal can be detected in the low frequency band for $f_0 = f_E - f_U$ or in the high frequency band for $f_0 = f_E + f_U$. The main advantage of this method is electrical signal detection on frequency different from frequencies of excitation signals, which allows to increase sensitivity to small defects and improve signal to noise ratio.

The main advantage of this method is electrical signal detection on frequency different from frequencies of excitation signals, which allows to increase sensitivity to small defects and improve signal to noise ratio. The method belong to nonlinear ultrasonic spectroscopy, which is new progressive non-destructive technology. It should increase a sensitivity of non-destructive investigation (reducing of minimum dimension of defect in relation to ultrasound wave length) and allows to perform defectoscopy of bodies with more complicated forms giving an information on integral characteristics of tested specimen (without localization of defects and need lower time for experiment performance).

The research in this domain has been realized in the frame of the Czech - Poland Intergovernmental S & T Cooperation Programme between Brno University of Technology, Faculty of Electrical Engineering and Communications, Department of Physics and Gdańsk University of Technology, Faculty of Electronics, Telecommunications and Informatics, Department of Metrology and Electronics Systems, included in the project entitled "*Ultrasonic Spectroscopy and Nonlinearity Testing for Passive Electronic Components Reliability*".

5. CONCLUSION

The nonlinearity measurements of electronic components and other objects present important diagnostic tools of their possible failures. The implementation of nonlinearity and fluctuation of TH measurements in the system for production testing of high reliability interference suppressor capacitors gives a possibility of individual testing of an every produced element for accepted criteria of testing and classification. The proposed gas-sensor measurement system enables improved gas detection taking into account selectivity and sensibility by means of the higher-order spectra as an extra source of information. Ultrasonic phonons interaction with electrons on defect nonlinearity as a method of non-destructive testing of conducting solids enables to improve signal to noise ratio and efficiency of defects detection.

6. REFERENCES

1. J. Sikula J., Hruska P., Vasina P., Schauer P., Kolarova r.: Noise and THI reliability indicators for thin film resistors. 10th European Passive Components Symposium CARTS-Europe'96, October 7-11, 1996, Nice, France, s. 200-209.
2. <http://www.miflex.com.pl/eng/capacitors/interference.htm>
3. Hasse L., Rogala K., Spiralski L., Turczyński J.: Factors determining the production testing of high reliability interference suppressor capacitors. Proc. 13th Int. Symp. Measurements for Research and Industry Applications IMEKO. Athens, 29.09.2004, vol. 1, s. 116-121, ISBN 960-254-644-1
4. Hasse L., Rogala K., Šikula J., Spiralski L.: Evaluation of Foil Capacitor Nonlinearities and Fluctuations During Manufacturing. 19th European Passive Components Symposium CARTS-Europe'05, October 17-20, 2005, Prague, Czech Republic, s. 217-223, ISSN 0887-7491
5. Hasse L., Smulko J., Spiralski L.: Gas detection in semiconductor sensors using fluctuation phenomena. Electronic Devices and Systems IMAPS CS Intern. Conf. 2005: Innovative Technologies for the Development of Electronic Products (Workshop): Proc.; Brno Czech Republic, 15-16.09.2005, s. 260-263.
6. Smulko J.M., Ederth J., Kish L.B., Heszler P., Granqvist C.G.: Higher-order spectra in nanoparticle gas sensors. Fluctuation and Noise Letters 2004, vol. 4, No. 4, s. L597-L603.
7. Spiralski L., Hasse L., Šikula J., Ćwilewicz R., Nondestructive Investigations of Materials and Mechanical Objects by Means of the Random Phenomena Analysis, Proc. Conf. *Physics and Materials Science, May 27-30, 2001, Vienna*, s. 86-93, ISBN 83-88443-75-5.
8. Johnson P., Ten Cate J.A.: Non-destructive Testing of Materials by Nonlinear Elastic Wave Spectroscopy, <http://www.ees.lanl.gov/ees11/nonlinear/diagnostics.html>

ANALIZA EFEKTÓW NIELINIOWYCH JAKO NARZĘDZIE DIAGNOSTYCZNE

Metody analizy efektów nieliniowych nieliniowej analizy sygnałów na wyjściu testowanych obiektów umożliwiają badanie występowania defektów i uszkodzeń w materiałach i elementach elektronicznych, co jest niezbędne w predykcji niezawodności. W odniesieniu do elementów biernych bardzo skutecznym narzędziem okazuje się być wskaźnik trzeciej harmonicznej (THI – *Third Harmonic Index*). W artykule bardziej szczegółowo opisano pomiary parametru THI i jego właściwości dla kondensatorów przeciwzakłóceń. Skrótowo przedstawiono zastosowanie bispektrum w analizie fluktuacji rezystancji czujników gazu. Wyszczególniono również zalety spektroskopii nieliniowej w badaniach nieniszczących obiektów.



