

## Analysis of pressure ratio in the intake in dependence on high-voltage behaviours

**Abstract.** Power control in spark ignition engines by regulating the intake air is performed. The control unit needs information about the air pressure conditions which then enters the combustion chamber. The information about the intake air pressure is an important quantity for optimal control of combustion mixtures. The paper describes some types of sensors that are used to measure the air intake temperature. Air pressure in the intake manifold affects the operation of the engine and also the extent of the loss or utility of the engine operation. Size of the over voltage sparks is also influenced by the air pressure in the combustion chamber which is proportional to the pressure manifold.

**Streszczenie.** W artykule przedstawiono wyniki badań dotyczących sterowania energią w silnikach o zapłonie iskrowym, poprzez regulację dostarczanego powietrza. Opracowany algorytm korzysta z informacji o ciśnieniu powietrza w komorze spalania. Omówiono także niektóre rodzaje czujników pomiaru temperatury pobranego powietrza. (Analiza zależności ciśnienia w otworze dolotowym od wyładowań elektrycznych).

**Keywords:** air pressure sensor, control, over voltage, Spark.

**Słowa kluczowe:** czujnik ciśnienia powietrza, sterowanie, przepięcie, iskra.

### Introduction

The intake air together with fuel creates burnt fuel mixture and combustion process takes place in the combustion chamber of engine in the cylinder. Correct composition of fuel mixture is the main requirement to get the maximum desired engine torque, the lowest possible fuel consumption and also the lowest volume of emissions in the exhaust.

Control unit regulates the composition of the mixture with aim to control the throttle opening and regulate opening of the injection valves. Throttle regulates the amount of incoming air. Control unit needs to obtain information about air pressure in the intake manifold through the pressure sensors for appropriate setting of throttle.

Four-stroke engines are characterized by the working cycle of piston in the cylinder which occurs in the four positions, thus in the two of crankshaft rotation. This process is called working circulation and functions as the circular plot, shown in Fig.1, which is repeated periodically.

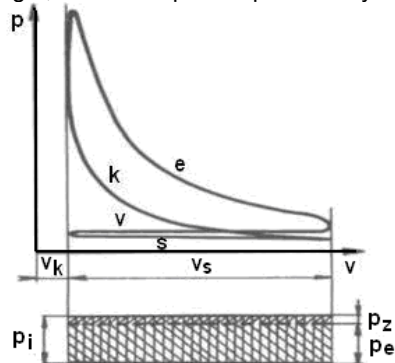

k - compression, e - expansion,  
p - cylinder pressure, p<sub>z</sub> - loss pressure  
p<sub>i</sub> - indicated pressure, p<sub>e</sub> - effective pressure  
v - volume, v<sub>s</sub> - cylinder volume,  
s - suction, v<sub>k</sub> - compression chamber

Fig.1. Indicator diagram of a four-stroke engine

This diagram describes dependence of the pressure  $p$  on the volume  $V$  during one working cycle of the piston in the cylinder. Indicator diagram is determined according to measurement of the pressure in the cylinder which depends on the position of the piston and time.

The area which is bounded by curves  $e$  and  $k$  represents positive work of gases during the expansion. The area bounded by the curves  $v$  and  $s$  characterizes a negative work required to exchange the contents of the cylinder.

Result indicates the work which is given by the sum of both, positive and negative work, and its absolute value is less positive than work.

In a circular diagram are relevant only engine pressure changes and associated changes of volume in the cylinders. Productivity of heat and media changes status (fuel / air mixture) has to be equal to the work done during expansion. This work was greater than the work needed to exchange media and compressing. [1]

Working circulation is composed of several processes: filling the column with the prepared mixture - opening the intake valve; when the intake valve is closed, compress the media with plunger occurs and thereby occurs increase the pressure and temperature.

When the mixture ignited by an electrical spark increase the pressure and temperature in the cylinder, expansion mixture pushes on the cylinder, the energy is transferred into the mechanical system and the system is cooled, ending the cycle by opening exhaust valves to cause emptying of the cylinder.

In mechanical work (pressure and movement of the piston) and the heat exchange with the walls of an enclosed space, energy is exchanged with the surroundings. Under the first law of thermodynamics applies the law of conservation for energy to the heat  $Q$ , internal energy  $E$  and work  $W$  is

$$(1) \quad dQ = dE + dW$$

Mechanical work is expressed as the product of pressure  $p$  of the volume  $V$  as

$$(2) \quad dW = pdV$$

Energy obtained from one working cycle is equal to the area closed curve PV diagram

$$(3) \quad E = \oint pdV$$

Pressure at intake has a major impact on the size of the over voltage. Size of pressure in the combustion chamber at the end of the compression stroke can be derived from the engine load, for example, the signal from the pressure sensor in the intake channel, or from sensor of the intake air mass. It is obvious that a low flow of air in the intake pipe (much closed to throttle) into the combustion chamber receives minimum amount of mixture which is pressed, subsequently presence of a relatively little pressure is recognizable. Conversely, if the throttle is fully open into the cylinder, it receives maximum amount of mixture and after the compression at the end of the compression stroke the considerable pressure occurs. [2]

### Theory of sensing and control of intake pressure

Thick film pressure sensor (Fig.2) is occasionally a kind of sensor used as an alternative to a micromechanical pressure sensor (in engine management systems Mono-Motronic and Motronic). Measuring range of sensor is 20 - 400 kPa (0.2 - 0.4 bar) and is also used as the supercharging pressure sensor.

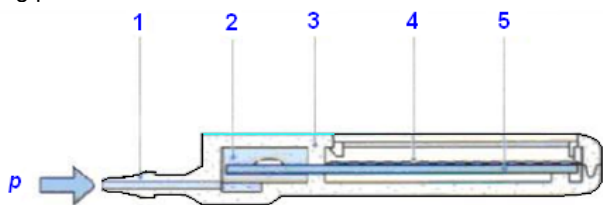

- measuring section: 1 - pressure connection  
2 - measuring cell  
3 - sealing component
- signal processing: 4 - evaluate circuit  
5 - thick-film hybrid circuit on ceramic substrate

Fig.2. Thick film pressure sensor

Sensing part of the sensor (measuring cell) is composed of thick film membrane whose dependence on the size of the measured pressure is deflected. In the membranes four dilated resistors in bridged composition are placed: two active resistors whose change their conductivity depend on mechanical stress (measured pressure) and two passive expansion resistors which work as a temperature compensation. Deflection of the membrane by pressure causes a change in bridge balance. Measured voltage  $U_M$  bridge is the yardstick for measuring the pressure  $p$  (Fig.3).

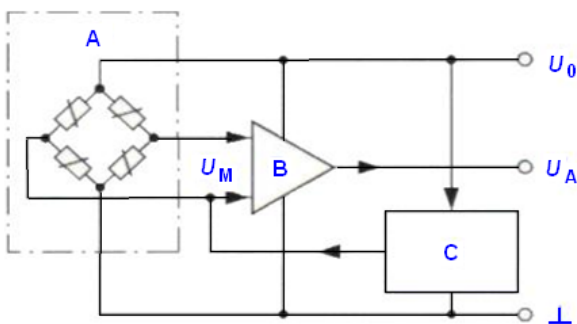

- A - DMS cell  
B - amplifier  
C - temperature compensation component

Fig.3. Thick film pressure sensor (connections)

For combustion of fuel the oxygen is needed, which from the engine intake air is taken. For engines with internal preparation of mixture (injection into the intake manifold) and also for engines with direct gasoline injection (seamless operation of the air / fuel ratio  $\lambda = 1$ ) is developed torque which is directly dependent on the weight of incoming air.

The throttle located in the intake channel controls the stream of air intake in the cylinder of engine. Change in the mass of air intake leads to a change in suction pressure.

In the Fig.4 the principle of control of air is shown. In traditional systems is the throttle controlled mechanically (by cable). Wire or rod transfers the movements of the accelerator pedal to throttle. Variable angle adjustment of throttle affects the cross-section of inlet channel and manages the flow of engine intake air and the turning moment.

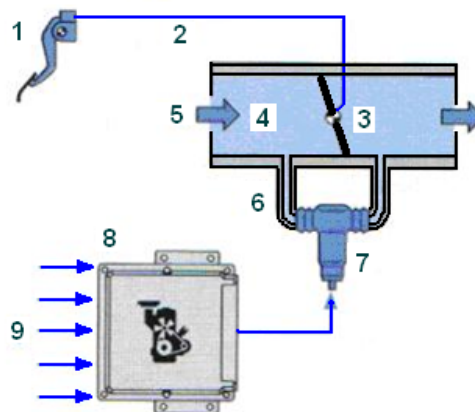

- 1 - accelerator pedal, 2 - rod, 3 - throttle,  
4 - suction channel, 5 - intake air flow,  
6 - airflow bypass, 7 - valve idle,  
8 - controller, 9 - input quantities (electrical signals)

Fig.4.Principle of air control in the usual systems

A cold engine needs more air and more fuel to offset the higher friction torque. For example, also when you turn on air conditioning compressor it needs a large proportion of air to compensate for loss moment. This information is fed into the control unit by means of electrical signals.

Increased air consumption is covered in two ways. The idle control valve conveys to the throttle more airflow from the bypass, or throttle adjuster changes the minimum back-stop of throttle. However, in both cases is necessary airflow to engine electronically affect only a limited extent. For example to regulate speed. [5]

### Experimental measuring of pressure conditions

Operating condition of engine was diagnosed in auto electric Laboratory at the University of Žilina (Fig.5). Experimental measurements of pressure ratios were performed in the interval between idling and full load.

Idling we can monitor and measure without difficulties, but the condition of full engine load can be adequately monitored only if laboratory is specified (on a roller brake).



Fig.5. Autodiagnosics laboratory at the University of Žilina

In the Fig.6 the speed and pressure of motor obtained by the oscilloscope OBD KTS 520, which allows obtaining the values directly from the control unit is shown.

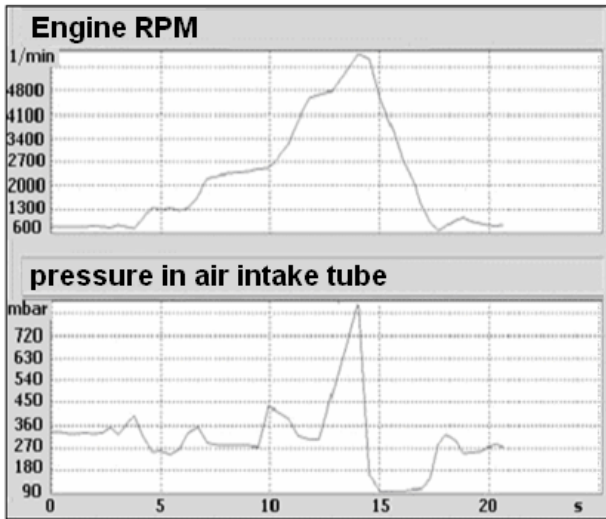

Fig.6. The speed and pressure obtained from the control unit

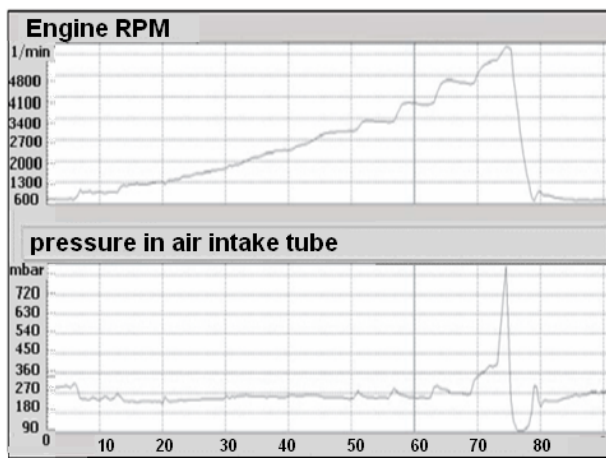

Fig.7. The speed and intake pressure at very slow opening throttle

When idling stabilizes the pressure in the intake channel, achieved value is influenced by the tightness of the intake manifold behind throttle and regulation of idle through the bypass channel around the throttle.

As the result of idling big losses strangulation occurs because the throttle is almost closed (there is a large vacuum, which act against the engine run).

Conversely mechanical friction causes losses of moving parts such as engine friction, piston rings on cylinder walls, friction in the crankshaft system, friction in the auxiliary aggregates (alternator, oil pump, fuel pump), or loss of swirling air in the crankcase (they are relatively low).

Idling is also characterized by low thermal efficiency of the engine due to a small ignition advance. A small advance to achieve good levels of emissions, mainly hydrocarbons, whose concentration increases with the increase of the ignition advance is needed.

Another negative influence exerted on the engine at idling is worse function manifold pressure that is set to provide optimal timing in areas where the highest torque moment is needed.

#### Record of low pressure gas in a slow addition

In the Fig.7 the engine speed and course of pressure to the intake manifold is shown. The lowest intake pressure is between 1300 -1500 rpm min-1. Upon further speed increasing the low pressure increases slowly, losses of throttle are small and increase mechanical losses.

A short-term slight increased in pressure is effect occurring due to rotation of throttle. Pressure in the intake is still lower than the idling. Only when the speed approach the value of 6000 min-1, the suction pressure starts to rise quickly (turning angle of the throttle is still relatively small), and only at full throttle there is a sharp increasing manifold pressure to atmospheric pressure.

During acceleration a slight increase in short-term pressure due to changes in rotation of throttle occurs. When you quickly close the throttle, the engine braking is maximal and pressure is lowest in the intake channel. [3], [5]

#### The pressure in the intake and sparking voltage

Pressure in intake has a dominant influence on the size of the over voltage, when idling gets the size of voltage peaks about 8 to 11 kV (the secondary voltage of transformer) in Fig.8.

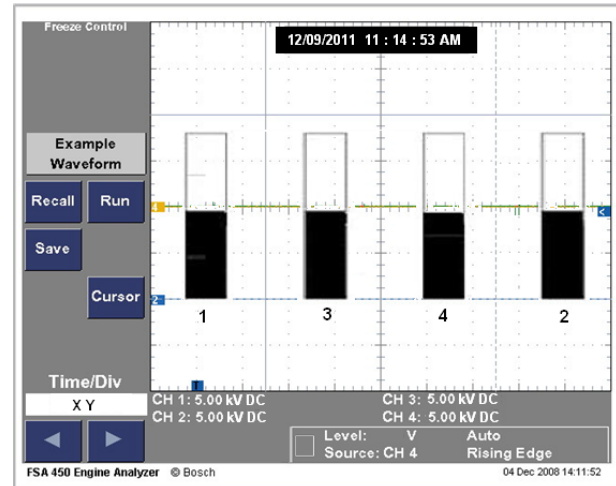

Fig.8. Graph of secondary voltage for each cylinder at idle

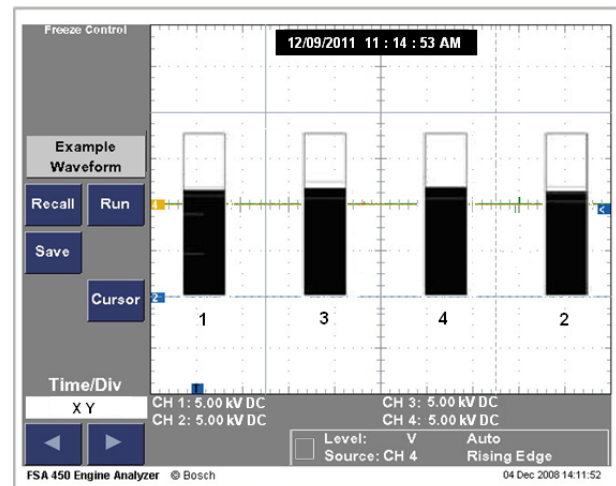

Fig.9. Graph of secondary voltage for each cylinder at higher engine speeds

Shortly after reaching full throttle opening, the cylinder receives large amount of air. At that point engine is almost fully loaded, because it overcomes the moments of inertia of rotating parts.

When the air is compressed, a high pressure in cylinder occurs. This corresponds to an increase over voltage (Fig.9) to about 15 kV.

This high engine load is only momentary, when is the engine accelerated to a higher speed, the load in the cylinder declines, there is the smaller amount of compressed

air resulting in a lower pressure in the cylinder - below the transformer secondary voltage (Fig.10).

In addition, shortly after stepping on the gas pedal as soon as the motor starts spinning from idle to maximum speed, ignition advance is increasing by jump. This is obviously reflected in the pressure in the cylinder at the moment of jump-spark.

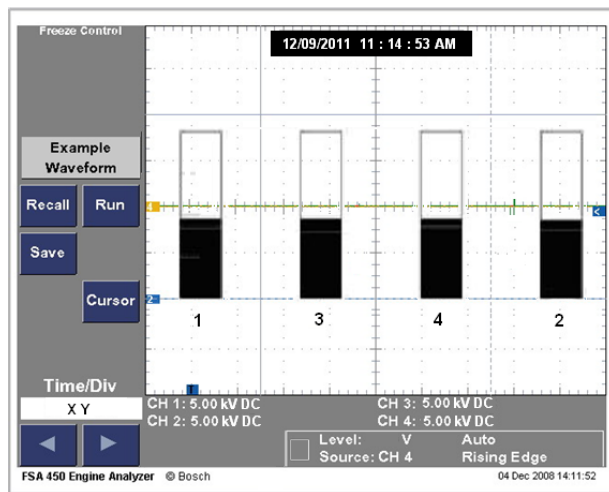

Fig.10. Graph of secondary voltage at higher revs

The graph in the Fig.11 illustrates how the wrong time of ignition adversely affects the pressure in the cylinder.

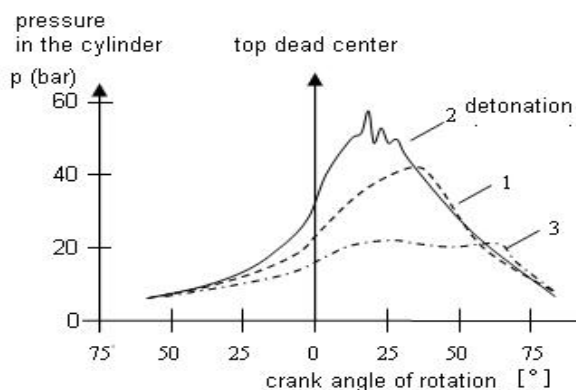

Fig.11. Dependence of rotation angle cranks and cylinder pressure

The curve 1 represents the correct combination ignition of mixture. The curve 2 represents the ignition of mixture. The mixture is ignited before high point of piston and the pressure works against motion of the piston, (the engine is rattles) what can be destructive in the engine and reduces his performance. The curve 3 represents the late ignite of the mixture. In this case an ignite mixture until well beyond the high point of piston with engine has low power on move of crankshaft.

### Conclusion

A more detailed analysis over the manifold pressure in various situations with oscilloscope system KTS 520 is investigated. The system is connected to the terminals of the pressure sensor which allow us to measure and diag-

nose the voltage on the sensor, therefore, manifold pressure.

For different application methods of engine load is clear that in slow rotate of non-loaded engine a low pressure in the intake in the whole course of acceleration occurs. The pressure was sharply increased at the value of the maximum engine speed, when the throttle was fully opened.

When the sharp in engine speed increases, the engine is exposed to high moment of rotating parts inertia, which translates on the pressure in the intake. Pressure rises sharply with increasing speed. After closing the throttle is pressure plummeted to the lowest value. It follows that the suction pressure is proportional to the load engine, and so is adapted also to the throttle.

When the changes of pressure in the combustion chamber on to size of over voltage are analyzed, the over voltage increase connected with increase of pressure can be seen.

This effect is also related to the ignition advance, because in the bigger ignition advance the pressure in the cylinder is lower. Over voltage is bigger in a richer mixture, which has a lower electrical resistance. Among other effects can be the voltage polarity, electrode distance, the wear and temperature.

Based on the height of columns (size over voltage) can be analyzed the ratios of the pressures of the engine cylinders, where the change in ratios of pressures is proportional to the size of the over voltage.

### REFERENCES

- [1] Ferenc, B.: Spalovací motory. In: Computer Press, 2006
- [2] Hlavňa, V. a kol.: Dopravný prostriedok – jeho motor. In: Žilinská univerzita, Žilina, 2000
- [3] Jičínský, Š.: Osciloskop a jeho využití v autoopravárenské praxi. In: Grada, Praha, 2006
- [4] Robert Bosch a kol.: Snímače v motorových vozidlech. In: odbytová spol. s r.o., Praha 2003
- [5] Robert Bosch a kol.: Řízení zážehového motoru. Základy a komponenty. In: odbytová spol. s r.o., Praha, 2002
- [6] Kučera, M., Kučera, A.: Efficiency of rope transport, In: Horizonty dopravy, Vol. 19, No. 5, 2011
- [7] Kučera, M., Kučera, S.: Ekologické kritéria pre mestskú dopravu, In: Železničná doprava a logistika, 2008, No. 3
- [8] Šimko, M., Chupáč, M.: Non-destructive method of measurement of radio transmitters antenna systems, In: Elektronika ir elektrotechnika = Electronics and electrical engineering, Vol. 107, No. 1, 2011
- [9] Marasová, D., Kučera, M.: Electric drive application for a conveyor loader with decreased energy demands, In: 8<sup>th</sup> International Conference Modern Electric Traction in Integrated XXIst Century Europe, Warszawa, Poland, 2007

### Authors:

Ing. Milan Šebök, PhD., doc. Ing. Miroslav Gutten, PhD., Ing. Daniel Koreňák, PhD.

Department of Measurement and Application Electrical, Faculty of Electrical Engineering, University of Žilina, Univerzitná 1, 010 26 Žilina, Slovakia, Email: [gutten@fel.uniza.sk](mailto:gutten@fel.uniza.sk)

Ing. Mikołaj Bartłomiejczyk, PhD., Department of Electrical Transport Engineering, Faculty of Electrical and Control Engineering, Gdańsk University of Technology, ul. Sobieskiego 7, 80-216 Gdańsk, Poland, E-mail: [mbarlom@elvy.pg.gda.pl](mailto:mbarlom@elvy.pg.gda.pl)