

ANALYSIS OF THE HYDRODYNAMIC PROPERTIES OF THE 3-COLUMN SPAR PLATFORM FOR OFFSHORE WIND TURBINES

Ewelina Ciba*

Paweł Dymarski

Mirosław Grygorowicz

Gdańsk University of Technology, Poland

* Corresponding author: eweciba1@pg.gda.pl (E. Ciba)

ABSTRACT

The article presents a design of a floating platform for offshore wind turbines. The concept is a modification of the Spar design and consists of three variable section columns connected to each other by a ballast tank in the lower part of the platform. This solution makes it possible to influence the position of the centre of buoyancy and the centre of mass of the structure. Compared to the classic Spar platform structure, the centre of buoyancy can be higher than mid-draft, which will provide the platform with greater stability. At the same time, this concept is better, in terms of technology, because of its modular structure and smaller bending radii. On the basis of the model testing performed, the hydrodynamic coefficients of the designed platform and its response to a given regular wave were determined (the transfer functions for heave and pitch motion were determined). Then, based on the damping coefficients, the platform was modelled in the ANSYS AQWA program and the results were very similar.

Keywords: 3-column spar platforms, damping coefficient, Floating Offshore Wind Turbines (FOWTs), RAO, AQWA

INTRODUCTION

Interest in offshore wind energy has not waned over the years. Initially, fixed structures were installed but Floating Offshore Wind Turbines (FOWTs) are becoming more common. There are different concepts for wind turbines based on various types of supporting structures. The design of a turbine based on a jack-up platform was described by Dymarski [1] and a design based on a tension leg platform was presented by Żywicki [2]. Most often, however, due to the large depths of the planned installation areas, offshore wind turbine designs are based on spar-type platforms, as presented by Dymarski [3]. This paper presents the concept of a Spar-type platform consisting of three columns with a variable cross-section, connected by a ballast tank at its base (Fig. 1).

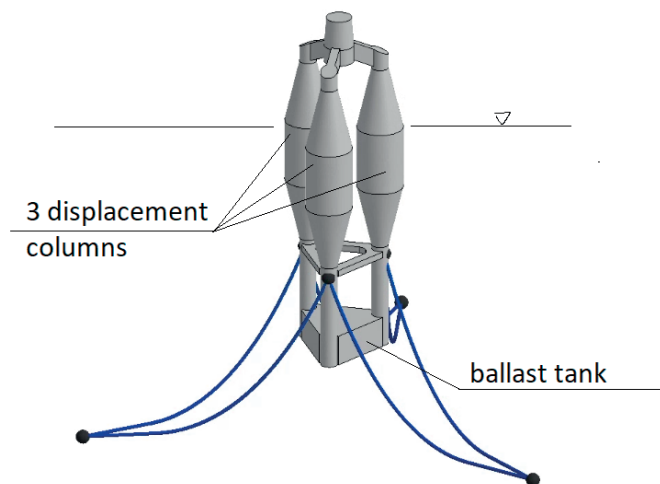

Fig. 1 The concept of the three-column spar platform

The designs for Spar platforms for offshore wind turbines are, of course, based on conclusions drawn from research carried out in the oil industry. There are many examples of platform simulations based on the diffraction method in the literature. However, experience shows that, in order to be compatible with these experiments, the methods should be extended to include damping due to the viscosity of the water. It is common practice to divide the structure into larger elements, calculated by the diffraction method, and smaller, slender elements calculated by the Morison method. The Morison method also applies to damping plates; taking into account the damping of the viscosity is extremely important.

Wang [4] presented Response Amplitude Operator (RAO) and irregular wave analysis for the Cell-Spar concept for an offshore wind turbine platform. However, the presented results are based solely on the diffraction method and do not take into account the influence of viscosity. This is too much of a simplification in this case because four heave plates are used. Diffraction methods underestimate the values of both water added mass and damping for heave plates. Hence, the maximum resulting RAO value for heave was 4, while the expected value in this case is approximately 2.2. Similarly, Li [5] presented a simplified analysis of the offshore wind turbine platform, obtaining a fairly good agreement of the results for surge RAO. However, larger discrepancies were observed for heave and pitch. The most likely reason for this is probably because the vertical force from the wave and the damping factors in this direction have not been taken into account, hence the model is too simplified for the determination of heave and pitch.

Zhang [6] presented a numerical study on the hydrodynamic behaviour of a new cell-truss spar for the oil industry. The calculations for the main part of the structure were based on the diffraction method and the truss elements were calculated based on the Morison equation. The additional damping for heave plates was not included, which may be too simplistic in this case. Sinsabvorodom [7] presented innovative designs for a three and four-column cell-truss spar, compared to the classic truss spar used in the oil industry. The analysis was carried out mainly in terms of hydrostatic stability, however, hydro-responses were also investigated. The analyses were carried out in the ANSYS AQWA program. The wave forces on the beam-column and truss elements were calculated using the Morison equation, the diffraction method being used on the remaining elements. The calculations confirmed that the applied solution is better than a classic truss spar, showing less surge displacements but not in the heave direction. Pitch values were not shown. The inclusion of additional damping due to viscosity could change these results significantly.

Li [8] designed and analysed the New Deep Draft Platform for the oil industry. A high order boundary element method, based on potential theory and modified Morison equations, was used to predict the hydrodynamic and viscous effects of this new concept platform. The use of three heave plates and reduced ballast gave very good results for the carry function compared to the traditional truss spar - max Heave RAO = 1.6 (truss spar 2.2) and max Pitch RAO = 1 (truss spar 7). The

same author [9] analysed the damping effects for an innovative deep draft multi-spar platform for the oil industry. Particular attention was paid to the problem of Mathieu instability, which causes significant pitch, due to loss of stability during heave. The structure was divided into those elements solved using diffraction theory and those of the Morison type. The analysis showed that significant heave damping reduces the risk of Mathieu instability. Heave plates and hydrodynamic damping at mooring lines have a significant influence here. The damping effect of the plates was analysed in the next article by Li [10]. This paper provided extensive analyses for a deep draft multi-spar for the oil industry, with damping plates in various configurations. The program AQWA was used to predict the frequency-dependent hydrodynamic coefficient and wave forces, noting and taking into account that a correction for viscosity was required. Damping factors were applied separately to the various elements of the structure. This showed that the use of constant damping gives much larger maximum displacements at the resonance point than the Optimized Scheme used by him and confirmed by experiment.

In order to determine the values of the hydrodynamic coefficients of the structure (the added water mass coefficient and the damping coefficient), tests were carried out on the models. Such a procedure is common practice and has been described, for example, by Messi [11]. The research on hydrodynamic coefficients was also described by Ciba in [12] and [13]. The determination of the hydrodynamic coefficients allows them to be compared, to assess the quality of the applied structure modifications and, based on linear models, to quickly predict the behaviour of the structure on a wave. Their values also allow the influence of viscosity to be taken into account in programs based on the diffraction method, e.g. ANSYS AQWA.

Many other researchers have studied the hydrodynamic coefficients of oscillating structures. Holmes [14] counted the added mass and drag coefficient using the least-mean squares method to fit Morison's equation to the force resultant histories predicted by the Computational Fluid Dynamics (CFD) solutions. The studies confirmed that the results of the direct solution of the Navier- Stokes equation can be an efficient and effective supplement to Morison type simulations in platform design.

The next step was to carry out model tests of the platform on a regular wave. The results were compared with the results of the analysis performed in the ANSYS AQWA program, obtaining a very good convergence.

Similar analyses were carried out by Sethuraman [15] for the stepped-spar offshore wind turbine. The conducted free oscillation tests allowed the model to be calibrated in the OrcaFlex program. As a result, very good agreement with the experimental results was obtained. The results allowed for the creation of amplitude characteristics of the heave and pitch motion of the platform, depending on the frequency of the exciting wave. Liu [16] presented the validation of the calculation results obtained through the use of the (widespread) FAST software for the Spar-type platform.

The calibration of the Spar-type platform model in the FAST program, using the results of free oscillations, was performed by Browning in [17].

The study of the amplitude characteristics was also presented by Shin [18] for the assessment of various modifications of the Spar type structure. The research shows the benefits of using damping elements.

MATHEMATICAL DESCRIPTION OF ISSUE

When submerged, under the influence of the initial force, the cylinder makes an oscillating motion relative to the equilibrium position, with the amplitude of the movement decreasing with time. A mathematical description of the issue can be found in the literature [11].

It is assumed that the moving body is rigid and the surface and volume forces are replaced by the movement of the point associated with the origin of the coordinate system. It is also assumed that the coefficients of the equation are constant over time, which causes the equation to become linear. This assumption is only true for a small amplitude of motion. In this case, the deflection is not more than 6 cm, so it can be used. The cylinder motion equation is given as:

$$(m + a) \cdot \ddot{z} + b \cdot \dot{z} + c \cdot z = 0 \quad (1)$$

where:

z – vertical displacement [m]

m – solid mass of cylinder [kg]

a – hydrodynamic mass coefficient [kg]

b – hydrodynamic damping coefficient [kg/s]

c – restoring spring coefficient [kg/s²]

Equation (1) can be written as:

$$\ddot{z} + 2\nu \cdot \dot{z} + \omega_0^2 \cdot z = 0 \quad (2)$$

where the damping coefficient and the undamped natural frequency are defined as:

$$2\nu = \frac{b}{m + a} \quad \omega_0^2 = \frac{c}{m + a} \quad (3)$$

A non-dimensional damping coefficient κ is defined as:

$$\kappa = \frac{\nu}{\omega_0} = \frac{b}{2\sqrt{(m + a) \cdot c}} \quad (4)$$

Knowing the results of the free decay tests, we can calculate:

$$\kappa = \frac{1}{2\pi} \cdot \ln \left\{ \frac{z_{a_i} - z_{a_{i+1}}}{z_{a_{i+2}} - z_{a_{i+3}}} \right\} \quad (5)$$

Depending on the averaged displacement amplitude:

$$\bar{z}_a = \left\{ \frac{z_{a_i} - z_{a_{i+1}}}{z_{a_{i+2}} - z_{a_{i+3}}} \right\} \quad (6)$$

The hydrodynamic added mass coefficient is calculated as:

$$a = \frac{c}{\omega_0^2} - m \quad (7)$$

In the case of initial displacement z_a , Eq. (2) takes the form:

$$z = z_a e^{-\nu t} \left(\cos \omega_z t + \frac{\nu}{\omega_z} \sin \omega_z t \right) \quad (8)$$

Due to the fact that, for the frequency of free oscillations, $\omega_z^2 = \omega_0^2 - \nu^2$ and when the damping is small, $\nu < 0.20$, $\nu^2 \ll \omega_0^2$, we can skip ν^2 and write that $\omega_z \approx \omega_0$.

DETERMINATION OF HYDRODYNAMIC COEFFICIENT BASED ON MODEL TESTS

The photo of the tested model is shown in Fig. 2.

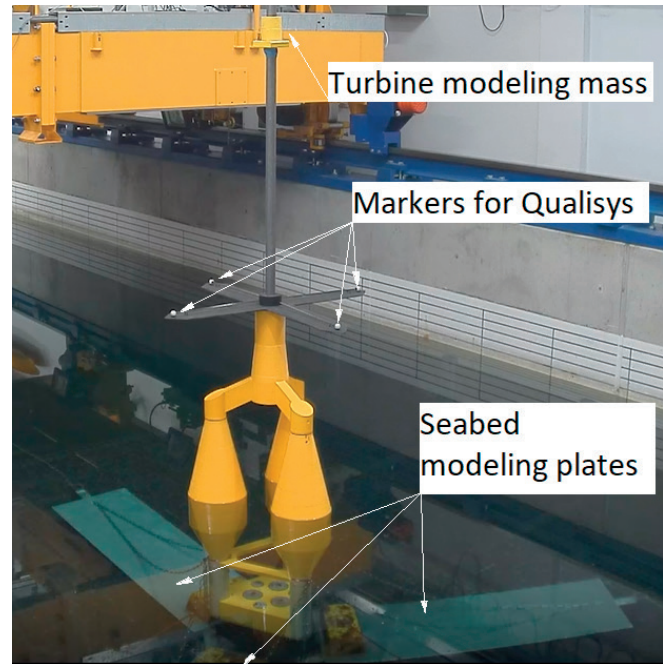

Fig. 2 Photograph of the model on the towing tank

The model tests were carried out in a 40x4x3 m model pool at the Gdańsk University of Technology, equipped with a plate and an 8-segment regular and irregular wave generator (with a given spectrum of waves) with a maximum height of 0.25 m, designed and made by Edinburgh Design.

Structural displacements were measured by a system based on high-speed cameras, to determine the position of the 6D object, named Qualisys. Measurements were made with an accuracy of 0.4 mm. Displacements and rotations were measured relative to the origin of the coordinate system assumed on the free surface.

Four series of measurements of the free heave and pitch were carried out, the typical course of which are shown in Fig. 3 (heave) and Fig. 4 (pitch).

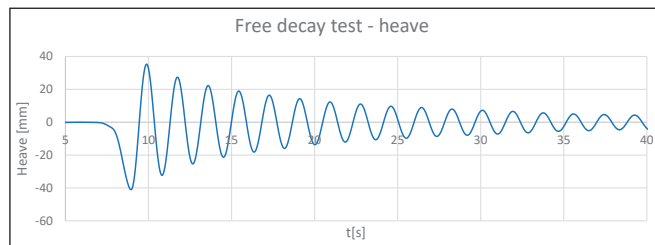

Fig. 3 Free Decay test - heave

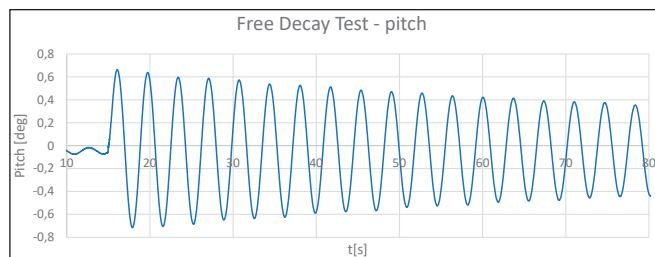

Fig. 4 Free Decay test - pitch

Then, the amplitudes of successive deflections were read and the dimensionless damping coefficient was calculated using Eq. (4). The results are presented in the graphs in Fig. 5 (heave) and Fig. 6 (pitch).

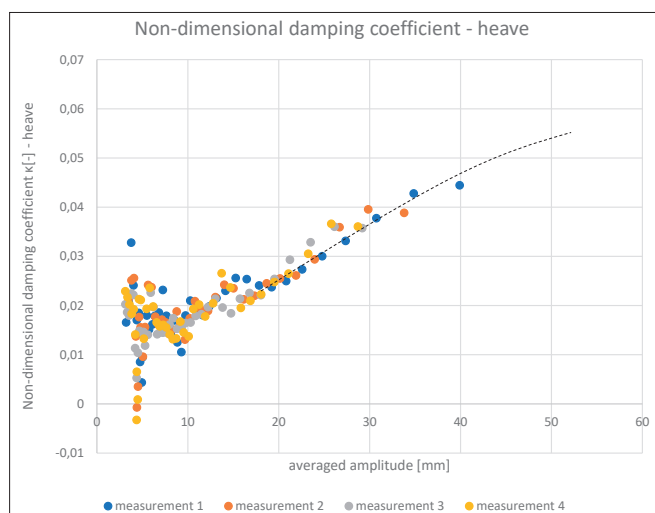

Fig. 5 Non-dimensional damping coefficient - heave

Since the tests were carried out for small amplitudes, in relation to the expected displacements on the wave, the graph is marked with the curve of the expected increase in the value of the coefficient (dashed line).

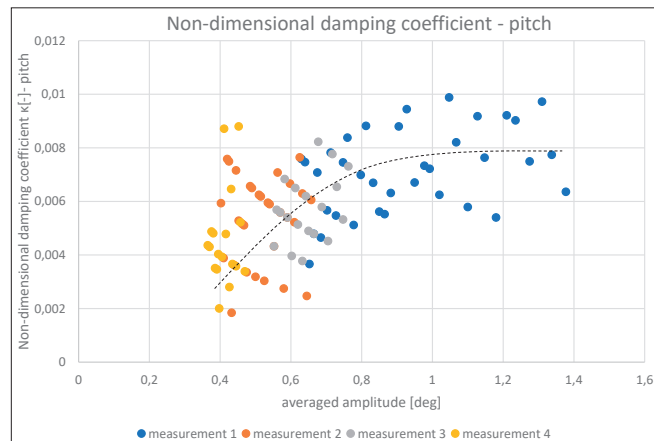

Fig. 6 Non-dimensional damping coefficient - pitch

Due to the significant differences in the obtained values, the approximate average value of the dimensionless damping coefficient is plotted on the graph (Fig. 6) with a dashed line.

Based on Eq. 7, the added water mass and the added water mass coefficient were determined, which are presented in the graphs in Fig. 7 (heave) and Fig. 8 (pitch).

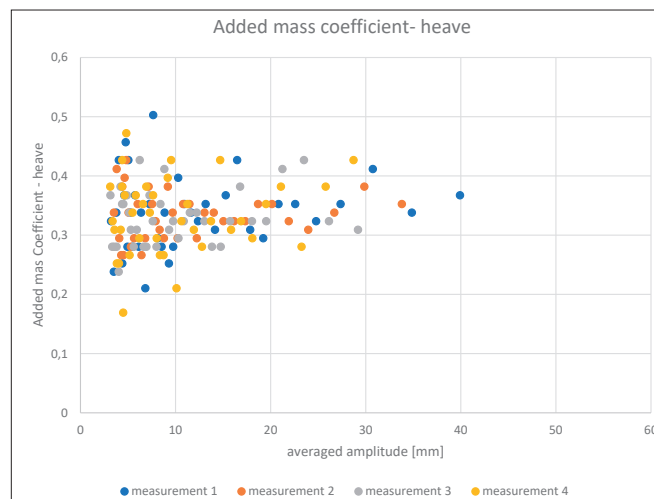

Fig. 7 Added mass coefficient - heave

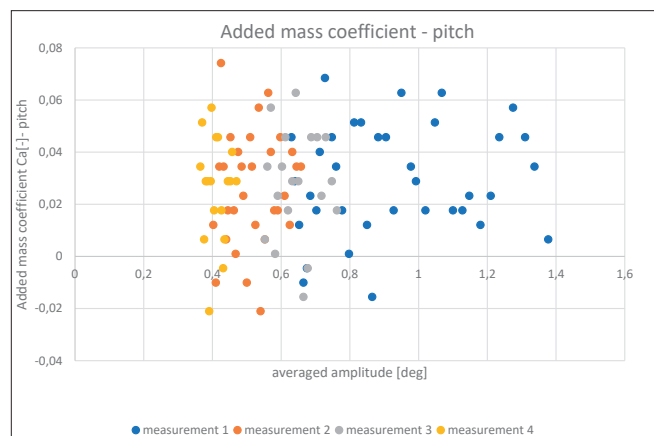

Fig. 8 Added mass coefficient - pitch

MODEL PREPARATION AND CALIBRATION IN ANSYS AQWA

For the purpose of calculations in the ANSYS AQWA program, a surface model of the platform was prepared, the most important dimensions of which are shown in Fig. 9.

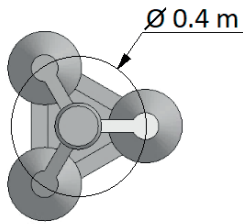
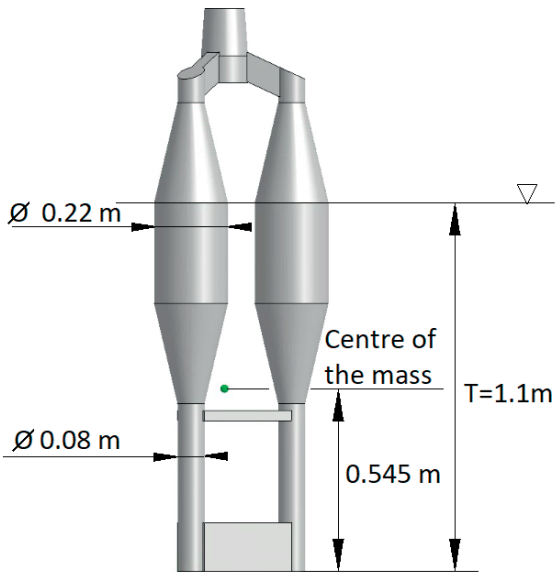

Fig. 9 Platform model

In accordance with the program requirements, the position of the centre of mass in the coordinate system related to the free surface and the moments of inertia, the values of which are presented in Table 1.

Tab. 1 Mass properties

Mass	71 kg
Centre of the mass	[0.0, 0.0, -0.555] m
Moment of inertia	[35, 35, 1.4] kg m ²

The anchor system was modelled as a Nonlinear Catenary type, which allowed reproduction of the used anchor chain with a mesh diameter of $d = 0.004$ m.

Then, for the given geometry, the damping coefficients and the added water mass were determined in the ANSYS AQWA program. The results depended on the frequency of the forcing wave and are presented in the diagrams in Fig. 10

(the attenuation coefficient for heave), Fig. 11 (the attenuation coefficient for pitch), Fig. 12 (the added water mass coefficient for heave) and Fig. 13 (the added water mass coefficient for the pitch).

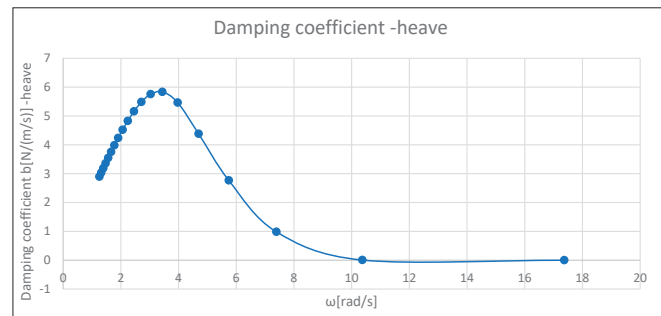

Fig. 10 Damping coefficient - heave

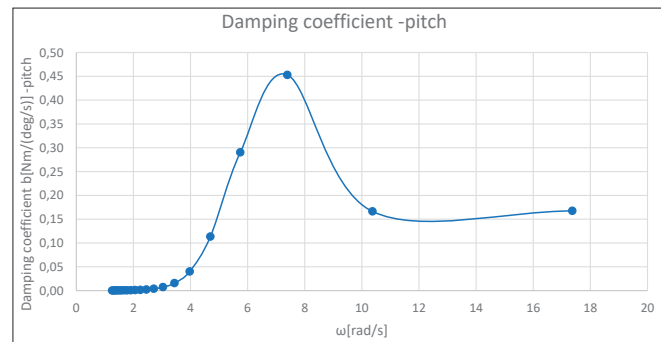

Fig. 11 Damping coefficient - pitch

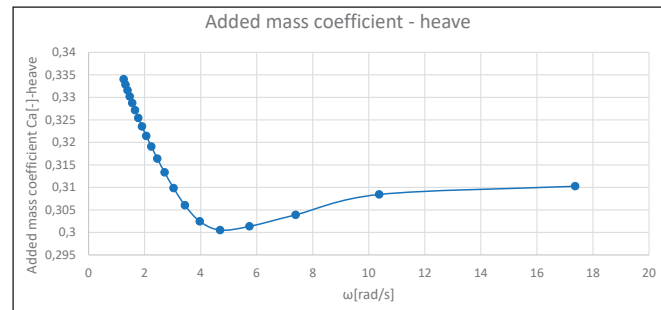

Fig. 12 Added mass coefficient heave

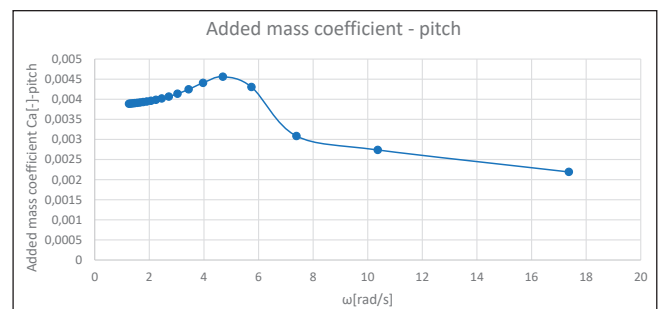

Fig. 13 Added mass coefficient - pitch

The predicted maximum amplitude of vertical displacements was ~ 0.06 m. The values of the dimensionless damping coefficient (Fig. 5) for this amplitude, approximated on the basis of model tests (FDT), for this amplitude were $\kappa = 0.55$, which gave the damping coefficient $b_{33} = 32$ [N / (m / s)]. Maximum pitch values were expected to be 4° . However, model tests were carried out for much smaller angles. The obtained plot of the dimensionless damping coefficient (Fig. 6) appears to flatten for the value of $\kappa = 0.008$, which gives the damping coefficient $b_{55} = 1$ [Nm / (deg / s)]. As noted, these are the values determined on the basis of free oscillation tests, i.e. for the fixed frequencies of natural oscillations; in this case, free heave $\omega_{33} = 3$ [rad / s] and pitch $\omega_{55} = 1.7$ [rad / s].

Because the value of the damping coefficient determined on the basis of the diffraction method at the frequency of free heave $\omega_{33} = 3$ [rad/s] was $b_{33\text{diffractive}} = 6$ [N/(m/s)], and the pitch damping coefficient at the free-pitch frequency $\omega_{55} = 1.7$ [rad/s] was $b_{55\text{diffractive}} = 0$ [Nm/(deg/s)], the added values $b_{33\text{additional}} = 26$ [N/(m/s)] and $b_{55\text{additional}} = 1$ [Nm/(deg/s)] were in accordance with Eq. (9).

$$b = b_{\text{diffractive}} + b_{\text{additional}} \quad (9)$$

The ANSYS AQWA program also takes into account the effect of the additional weight of added water. It is very useful, for example, for additional damping elements, such as the damping plates analysed by the authors and mentioned in the introduction, for which the diffraction method gives underestimated results. In this case, however, a high agreement of the coefficients determined by the program and those obtained from the experiment results was found, therefore this option was not used.

RESPONSE TO REGULAR WAVE

The prepared model was then used to determine the structure's response to a given regular wave. Waves of amplitude $\zeta_a = 0.02$ m were applied at different frequencies. Heave amplitudes were measured and used to build the Response Amplitude Operator (RAO) and pitch graphs presented in Fig. 14 (RAO heave) and Fig. 15 (pitch). The results of the calculations were compared with the results of model tests, obtaining a fairly good convergence.

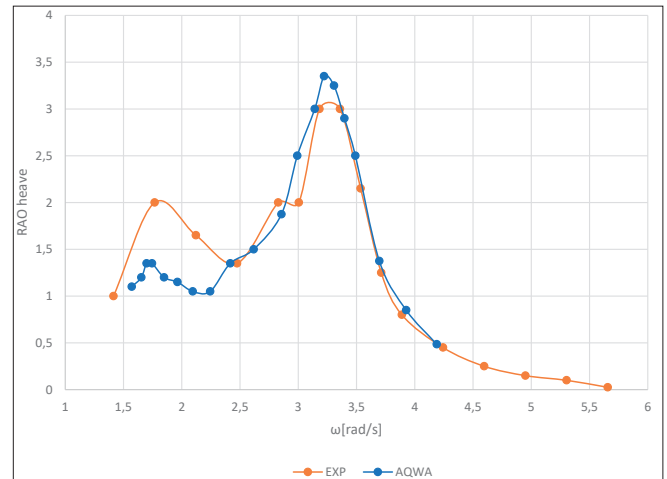

Fig. 14 Response Amplitude Operator heave

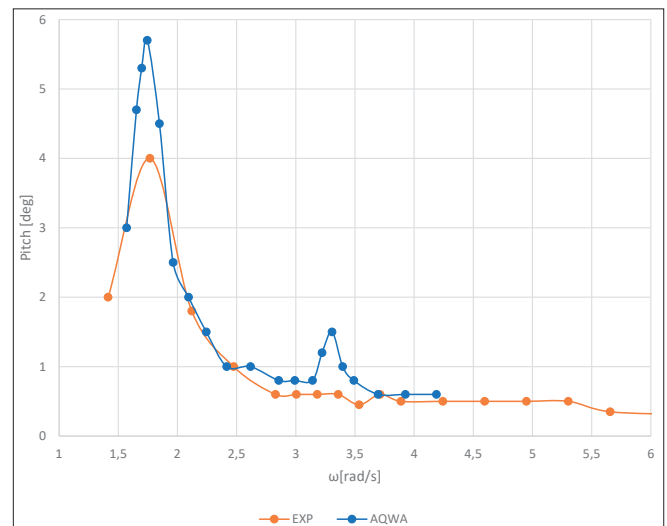

Fig. 15 Pitch platform for regular waves

CONCLUSIONS AND FURTHER WORK

Viscous damping is of great importance for the tested structures and cannot be ignored. Supplementing the ANSYS AQWA program with the coefficients determined from model tests allows for a fairly good approximation to predict the behaviour of the structure on a regular wave. However, the value of the hydrodynamic coefficients change, depending on the frequency of the forcing wave, and the program only allows the addition of a constant value which is independent of it. Free oscillation tests, although convenient to carry out, only allow the calculation of the coefficients for one frequency of free oscillation. Forced oscillation tests should be performed to obtain a fuller knowledge of the structure. The authors plan to carry out such calculations using the RANSE-CFD code.. The results may well explain the discrepancy between the results obtained in the ANSYS AQWA program and the values measured from the experiments.

The platform model was made at a 1:50 scale. For a wave with an amplitude $\zeta_a=1\text{m}$ and period $T=13.5\text{ s}$, this gives the amplitude of the displacement as $z_a\sim 3\text{ m}$, which is a significant value. To prevent this, future work is planned to assess the impact of additional damping elements on the platform movement.

ACKNOWLEDGEMENTS

The calculations were carried out in the ANSYS AQWA program under the license obtained in cooperation with MESco Sp. Z o. o.

REFERENCES

1. P. Dymarski, 'Design of Jack-up Platform for 6 MW Wind Turbine: Parametric Analysis Based Dimensioning of Platform Legs'. Polish Maritime Research, 26, 183-197, 2019. DOI: 10.2478/pomr-2019-0038
2. J. Żywicki, P. Dymarski, E. Ciba, C. Dymarski, 'Design of Structure of Tension Leg Platform for 6 MW Offshore Wind Turbine Based On Fem Analysis'. Polish Maritime Research, Vol. 24, s1, 230-241, 2017. DOI: 10.1515/pomr-2017-0043
3. P. Dymarski, C. Dymarski, E. Ciba, 'Stability Analysis of the Floating Offshore Wind Turbine Support Structure of Cell Spar Type During its Installation'. Polish Maritime Research, Vol. 26, 4(104), 109-116, 2019. DOI: 10.2478/pomr-2019-0072
4. H. Wang, X. Chen, Ch. Zhao, Y. Tang, W. Lin, 'Conceptual design and hydrodynamic performance of a floating offshore wind turbine cell-spar-buoy support structure, Applied Mechanics and Materials Vol. 472 pp 291-295, 2014. DOI: 10.4028/www.scientific.net/AMM.472.291
5. J. Li., Y. Xie, W. Wu, Ch. Zhang, 'Analysis Of The Dynamic Response Of Offshore Floating Wind Power Platforms' In Waves, Polish Maritime Research 4(108) Vol. 27, pp 17-25, 2020. DOI: 10.1007/s11804-010-1002-9
6. F. Zhang, R. Li, J. Yang, G. Chen, 'Numerical Study On The Hydrodynamic Behaviour Of A New Cell-Truss Spar Platform', in Proceedings of the International Conference on Offshore Mechanics and Arctic Engineering - OMAE, 2007, vol. 1, DOI: 10.1115/OMAE2007-29086.
7. Ch. Sinsabvarodom, J.H. Widjaja, 'The innovative hybrid Cell-Truss Spar Buoy Platform for moderate water depth', Ocean Engineering 113, pp 90-100, 2016. DOI:10.1016/j.oceaneng.2015.12.039.
8. B. Li, J. Ou, 'Concept Design of a New Deep Draft Platform', J. Marine Sci. Appl. 9: 241-249, 2010. DOI: 10.1007/s11804-010-1002-9
9. B. Li, J. Ou, B. Teng, 'Numerical Investigation of Damping Effects on Coupled Heave and Pitch Motion of an Innovative Deep Draft Multi-Spar', Journal of Marine Science and Technology, Vol. 19, No. 2, pp. 231-244, 2011. DOI: 10.51400/2709-6998.2158
10. B. Li, J. Ou, Z. Huang, Y.M. Low, 'Experimental and numerical study of the effects of heave plate on the motion of a new deep draft multi-spar platform', J Mar Sci Technol 18:229-246, 2013. DOI: 10.1007/s00773-012-0203-0
11. J. M.J. Journee, W.W. Massie, 'Offshore Hydromechanics.' Delft University of Technology. 2001.
12. E. Ciba, 'Heave Motion of a Vertical Cylinder with Heave Plates, Polish Maritime Research, vol. 28, issue 1(109), pp. 42-47, 2021. DOI: 10.2478/pomr-2021-0004
13. E. Ciba, P. Dymarski, M. Grygorowicz, 'Heave Plates with Holes for Floating Offshore Wind Turbines', Polish Maritime Research vol 29 pp.26-33, 2022. DOI: 10.2478/pomr-2022-0003
14. S. Holmes, P. Beynet, A. Sablock, I. Prislina, 'Heave Plate Design with Computational Fluid Dynamics', Journal of Offshore Mechanics and Arctic Engineering 123(1), 2001. DOI:10.1115/1.1337096
15. L. Sethuraman, V. Venugopal, 'Hydrodynamic response of a stepped-spar floating wind turbine: Numerical modelling and tank testing', Renewable Energy 52, 160-174, 2013. DOI:10.1016/j.renene.2012.09.063
16. H.B. Liu, F. Duan, F. Yu, B. Yuan, 'Validation of a FAST spar-type floating wind turbine numerical model with basin test data', IOP Conference Series: Earth and Environmental Science, Volume 188, 2018 International Conference on New Energy and Future Energy System, Shanghai, China.
17. J.R. Browning, J. Jonkman, A. Robertson, A.J. Goupee, 'Calibration and validation of a spar-type floating offshore wind turbine model using the FAST dynamic simulation tool'. Journal of Physics: Conference Series, Volume 555, 2014. The Science of Making Torque from Wind 2012 9-11 October 2012, Oldenburg, Germany
18. [18] H. Shin, P.T. Dam, K.J. Jung, J. Song, C. Rim, T. Chung, 'Model test of new floating offshore wind turbine platforms', Int. J. Naval Archit. Ocean Eng., 199-209, 2013. DOI:10.2478/IJNAOE-2013-0127

CONTACT WITH THE AUTHORS

Ewelina Ciba*

e-mail: eweciba1@pg.gda.pl

Paweł Dymarski

e-mail: pawel.dymarski@pg.edu.pl

Mirosław Grygorowicz

e-mail: snop@pg.edu.pl

Gdansk University of Technology,
Institute of Ocean Engineering and Ship Technology,
Gdansk,
POLAND