

Paper submitted for consideration to publish in the Applied Thermal Engineering

Analytical method for calculation of heat source temperature drop for the Organic Rankine Cycle application

Dariusz Mikielwicz^{a,b}, Jarosław Mikielwicz^b

^a Gdansk University of Technology, Faculty of Mechanical Engineering, Department of Energy and Industrial Apparatus, Poland, Email Dariusz.Mikielwicz@pg.gda.pl

^b Institute of Fluid-Flow Machinery PAS, Poland, Email jarekm@imp.gda.pl

Abstract

In the paper presented are considerations on the cooperation of the limited capacity heat source with the Organic Rankine Cycle unit. Usually the heat source providing thermal energy to the Organic Rankine Cycle (ORC) may have twofold characteristics. It can be in the form of a single phase fluid, i.e. as hot exhaust gas or hot liquid, or in some cases it may be available as a phase changing fluid, as for example, technological or geothermal steam. Such fluid will be condensed whilst supplying heat to the ORC evaporator. In case of the heat source in the form of a single phase fluid flow its temperature is decreasing in the course of heating of the ORC. In the paper a simple analytical method, based on the energy balance of evaporator, is presented for evaluation of the final temperature of the heat source for ORC installation for two cases, namely single phase fluid and phase changing fluid heat supply. Additionally, the ratio of the heating fluid to the ORC working fluid is presented in function of the minimum temperature difference between the heat source and working fluid.

Keywords: Organic Rankine Cycle, finite capacity heat source, effectiveness of utilization

1. INTRODUCTION

Considerable quantities of low-temperature thermal energy are available from natural sources (solar, geothermal, biomass) and industrial processes in the form of waste heat (power plants, chemical plants, etc.). Conversion of such energy into mechanical energy and subsequently to electricity is considered nowadays as a challenge and presents great opportunities. One of the branches of methods which can be used to achieve such conversion includes implementation of the vapor Clausius-Rankine cycle with organic substance as the working fluid, the so-called organic Rankine cycle (ORC).

Plant should be operated to achieve the highest conversion efficiency from the available heat source. Therefore, an optimal combination of evaporation temperature and mass flow rate of working fluid must be sought. The heat source providing thermal energy to the Organic Rankine Cycle is available usually in the form of hot exhaust gas or hot liquid flow. In some cases we may have at our disposal a phase changing fluid, which comes for example from the technological or geothermal vapor, which is condensing whilst supplying heat to the ORC evaporator. The characteristic feature of the single phase fluid heat source is that its temperature decreases when heat is extracted. That is also true in case of the condensing fluid, but in that case the distribution of temperature is different. In the case where there is a small temperature difference between the heat source and the ORC working fluid there can arise some kind of difficulty in heating and evaporating of the working fluid. During such process, the requirement for the existence of the minimum temperature difference between heating fluid and working fluid, the so-called “pinch temperature” restricts the reduction of the



available heat source temperature to the demanded level, contributing to the ineffective use of such heat source. That minimum temperature difference between the two media is usually assumed as 5°C. The attempt to utilize the heat source to the full extent, revealed in the significant reduction of its temperature, leads usually to lower evaporation temperatures of the working fluid in the ORC system, thus contributing a substantial reduction of thermal efficiency of ORC. The evaporation temperature of working fluid is regarded as one of the major parameters influencing the ORC efficiency. Majority of contributions in literature for ORC analyses treat the heat source as if it had an infinite heat capacity, that is its temperature remains constant (or vary to a small extent) during the heat supply to ORC. It leads to the fact that the heat source is not well exploited and in the case of waste heat utilization it can prove the poor economics of the ORC. Additionally, in order to sustain a small temperature drop of the heat source, the mass flow rate of heating fluid must be large, leading in such way to large pumping power.

Liu et al. [2] analyzed the effect of working fluids (water, ethanol, HFE7100, n-pentane, isopentane and isentropic: R11, R123, benzene) on the performance of subcritical ORCs. They indicated that assuming a constant heat source temperature can result in considerable design differences with respect to the actual variable temperature of finite heat sources such as geothermal or waste streams. Additionally they reported that the thermal efficiency of such cycles are a weak function of the critical temperature.

Saleh et al. [3] performed a thermodynamic analysis of 31 pure working fluids for ORCs with and without superheating, operating in temperature range between 100°C and 30°C. They found that the highest thermal efficiencies are obtained with dry fluids in subcritical cycles with regenerator. They also performed the “pinch analysis” for the heat transfer between the



source and the working fluid, and reported that the largest amount of heat can be transferred to a supercritical fluid and the least to a high-boiling subcritical fluid.

Lakew and Bolland [4] analyzed the power production capability and equipment size requirements for R134a, R123, R227ea, R245fa, R290 and n-pentane. They used a subcritical Rankine cycle without superheating, specified the heat source temperature in the temperature range from 80°C to 200°C and used the evaporator pressure as independent parameter. Their results show that the selection of working fluids depends on the type of heat source, the temperature level and the design objective. The latter can be either the maximum power output (turbine) or the smaller heat exchangers. It was shown that the maximum power is obtained for the optimal evaporator pressure. Furthermore, a working fluid may have the smallest turbine size factor but requires a large heat exchanger area. The authors concluded that an economic study is necessary to determine which working fluid is the most appropriate.

Recently Khennich and Galanis [5] compared the performance of a subcritical Rankine cycle with superheating, operating between a constant flow rate fixed-temperature (100°C) heat source and a fixed-temperature (10°C) sink, for five working fluids. Their results show the existence of two optimum evaporation temperatures. One minimizes the total thermal conductance of the two heat exchangers whereas the other maximizes the net power output.

There are numerous other works where fitting of the heat source to working fluid is considered to find optimum operation conditions of the ORC plant. The present work, however, is not about finding optimum operation conditions of ORC, but the relation between temperature drop of the heat source and possible evaporation temperature at a given minimum temperature difference between two fluids. Having obtained the initial and final temperatures

of the heat source, evaporation temperature and the ratio of mass flow rates of heating fluid to working fluid one can embark on the search of adjusting these conditions using other criteria. One of them to mention is to seek the ratio of the total heat transfer area to the total net power, Hettiarachchi et al. [6]. In literature, however, the usual approach to configure the heat source to the ORC is such that the exergy losses are sought to be smallest. Such approach can be found in Quoilin et al. [7], who developed a map of cycle efficiency on the basis of combination of mass flow rate/rotational speed. Astolfi et al. [8] presented numerous heat exchanger profiles on a temperature–heat plane explicitly expressing the need to a correct match of the heat source and working fluid heating characteristics. Tchanche et al. [9] indicate that the heat amounts transferred to the cycle through the preheater and evaporator depend upon the fluid. Therefore, the pinch point analysis should be considered when designing the system for an efficient heat transfer in the preheater and evaporator. Zhou et al. [10] uses exergetic efficiency along with cycle efficiency, heat recovery efficiency and output power of expander to evaluate the system performance. El-Emam and Dincer [11] introduced a sustainability index which is defined as a function of exergy efficiency and claim that exergy analysis appears to be a significant tool for energy systems which may contribute in improving the sustainable development.

In the present study cooperation of the ORC with the heat source available as a single phase or phase changing fluids is considered. The analytical models have been developed, which enable in a simple way calculation of heating fluid temperature variation as well as the ratio of flow rates of heating and working fluids in ORC. The developed analytical expressions enable also calculation of the outlet temperature of the heating fluid. These relations, however simple, have not been found in literature of the subject. That is maybe due to fact that normally the heat source temperature drop was not considered as crucial. In case of utilization of low-enthalpy heat, such as waste heat or geothermal heat, when there is an issue of highest

possible utilization of the heat source, the possibility of straightforward determination of final temperature of the source may be **important**.

2. ANALYTICAL MODEL FOR CALCULATION OF HEAT SOURCE TEMPERATURE DROP IN ORC INSTALLATION

The simple organic Rankine cycle is considered, consisting namely of the evaporator, turbine, condenser and circulation pump, Fig. 1. In case of so-called “dry” fluid, i.e. a fluid featuring a positive slope of the vapor saturation line in temperature – entropy diagram, the internal regeneration of the ORC could also be considered, Fig. 2. **In the analysis** it is assumed that the working fluid is in the state of saturated liquid at the outlet of the condenser. Its pressure is then raised by the pump to reach evaporation pressure. Subsequently the working fluid is heated reaching evaporation temperature and then is totally evaporated to reach the vapor saturation state. Next, the hot saturated vapor expands in the turbine performing the useful work. **Internal irreversibilities in turbine and pump are not considered, similarly as pressure drops in heat exchangers.**

2.1. Heat supply to the ORC by hot single phase fluid

The most common way of providing heat to the ORC installation is by means of the hot single-phase fluid. Such situation is schematically shown in Figure 3. In the considered case it is required that throughout the entire heating process the **minimum temperature difference, ΔT_{\min} , between two fluids is not to be overlooked**, i.e. the so-called pinch point temperature difference.

In order to develop a relationship between the heat source temperature change and the amount of heat supplied to the working fluid we apply the heat balance to the evaporator. In such case temperature of the working fluid raises from the state 4 to state 1 due to the transfer of heat from the heat source which results in its temperature change from state 6 to the final temperature of state 10, which reads as:

$$\dot{m}_{ORC}(h_1 - h_4) = \dot{m}_w(h_6 - h_{10}) \quad (1)$$

The process of heat supply to the isobaric-isothermal process from state 4 to state 1 consists first of the heating process of the ORC working fluid up to evaporation temperature T_1 and then its subsequent evaporation. Hence enthalpy h_1 can be written as:

$$h_1 = h_4 + C_{p\ ORC}(T_1 - T_4) + h_v(T_1) \quad (2)$$

Similarly, enthalpy h_{10} can be written as:

$$h_{10} = h_6 - C_{p\ w}(T_6 - T_{10}) \quad (3)$$

In equation (2) and (3) $C_{p\ ORC}$ denotes the specific heat of working fluid, regarded as its mean value in the temperature range from T_4 to T_1 , whereas the specific heat for the heat source, $C_{p\ w}$, is a mean value of the heat source fluid in the temperature range from T_6 to T_{10} . Such kind of approximation is sufficient in case of water or exhaust gases considered as heat sources in the present work. Additionally, $h_v(T_1)$ denotes the latent heat of evaporation at temperature T_1 .

Substitution of equation (2) and (3) into (1) results in:

$$\dot{m}_{ORC} [C_{p\ ORC}(T_1 - T_4) + h_v(T_1)] = \dot{m}_w C_{p\ w}(T_6 - T_{10}) \quad (4)$$

In equation (4), the unknown are two quantities, namely the temperature of heating fluid at outlet T_{10} and the ratio of mass flow rates $\dot{m}_w / \dot{m}_{ORC}$. Therefore, the second equation is required

to find these two unknowns. For that purpose the heat balance of the evaporator on its part ranging from inlet condition 6 to the pinch point 7 can be considered:

$$\dot{m}_w C_{pw}(T_6 - T_7) = \dot{m}_{ORC} h_{lv}(T_1) \quad (5)$$

Expression (5) enables the determination of the flow rate ratio $\dot{m}_w / \dot{m}_{ORC}$ as a function of evaporation temperature of working fluid in ORC installation. If we determine the temperature difference $(T_6 - T_7)$ from equation (5) and then subtract temperature T_1 from both sides of equation (5) we can obtain the temperature difference $(T_7 - T_1)$ in the form:

$$\Delta T_{\min} = T_7 - T_1 = (T_6 - T_1) - \frac{h_{lv}(T_1)}{\frac{\dot{m}_w}{\dot{m}_{ORC}} C_{pw}} \quad (6)$$

$(T_7 - T_1)$ is, on the other hand, equal to the minimum temperature difference between two fluids at pinch point ΔT_{\min} , i.e. the value which is assumed as a parameter at the beginning of calculations. Therefore the ratio of flow rates $\dot{m}_w / \dot{m}_{ORC}$ can be expressed as a function of the “pinch point” temperature difference as follows:

$$\frac{\dot{m}_w}{\dot{m}_{ORC}} = \frac{h_{lv}(T_1)}{C_{pw}[(T_6 - T_1) - \Delta T_{\min}]} \quad (7)$$

The temperature to which the heating fluid can be cooled is calculated from the rearrangement of equation (4) to the form:

$$T_{10} = T_6 - \frac{\dot{m}_{ORC} [C_{pORC}(T_1 - T_4) + h_{lv}(T_1)]}{\dot{m}_w C_{pw}} \quad (8)$$

At this stage the only outstanding issue in calculations is to properly assume the value of evaporation temperature and related to that the value of latent heat of evaporation $h_{lv}(T_1)$. If the evaporation temperature is not correctly assumed the outlet heat source temperature will

be too high, indicating poor utilization of the heat source. In such case the calculation procedure requires iterative selection of other values of evaporation temperature.

2.2. Heat supply to the ORC by the phase changing fluid

A similar analysis can be carried out for the case of the heat source in the form of the fluid changing its phase during the supply of heat to working fluid in ORC. A schematic of such process has been presented in Fig. 4.

Generally the mean temperature drop, usually regarded as a logarithmic mean temperature difference (LMTD), of the heating fluid in the evaporator will consist of three constituent regions, namely that corresponding to desuperheating of heating steam down to saturation conditions, $LMTD_1$, its condensation, $LMTD_2$ and subsequent subcooling, $LMTD_3$. That can be written as:

$$LMTD = \frac{LMTD_1 + LMTD_2 + LMTD_3}{3} \quad (9)$$

For the discussed case the overall heat balance of the evaporator is similar to the balance presented in equation (1), that is:

$$\dot{m}_{ORC}(h_1 - h_4) = \dot{m}_w(h_6 - h_{10}) \quad (10)$$

The second equation used in this analysis is the heat balance up to the location where the “pinch point” occurs:

$$\dot{m}_{ORC}(h_1 - h_5) = \dot{m}_w(h_6 - h_9) \quad (11)$$

It **must** be remembered that, similarly as in the previous case of heating the ORC installation by the single phase fluid, the transition from enthalpy h_4 to enthalpy h_1 of the working fluid consists first of heating process of working fluid to evaporation temperature T_1 , followed by its subsequent evaporation. Hence enthalpy h_1 can be written as in equation (2). Enthalpy h_{10} , resulting from the **transition** of heating fluid from its inlet temperature T_6 to condensation temperature T_7 , subsequent condensation **at** temperature T_8 and its subcooling to T_{10} can be written as:

$$h_{10} = h_6 - C_{pv}(T_6 - T_7) - h_{lv}(T_7) - C_{pl}(T_8 - T_{10}) \quad (12)$$

Substitution of equations (2) and (12) to (10) returns:

$$\frac{\dot{m}_w}{\dot{m}_{ORC}} [C_{pv}(T_6 - T_7) + h_{lv}(T_7) + C_{pl}(T_8 - T_{10})] = [C_{pORC}(T_1 - T_4) + h_{lv}(T_1)] \quad (13)$$

In (12) and (13) C_{pl} denotes a mean value of specific heat of liquid of the heating fluid (condensing steam) in the temperature range from T_8 to T_{10} , whereas C_{pv} stands for a mean value of specific heat of vapour in temperature range from T_6 to T_7 . The latent heat of condensation of heating fluid is denoted as $h_{lv}(T_7)$. In equation (13), **the** unknown are the values of outlet temperature of heating medium T_{10} and the ratio of mass flow rates $\dot{m}_w / \dot{m}_{ORC}$. In order to obtain the second equation enabling determination of the two above quantities we write the heat balance equation for the heat balance from the node 6 to the pinch point, state 9:

$$\frac{\dot{m}_w}{\dot{m}_{ORC}} [C_{pv}(T_6 - T_7) + h_{lv}(T_7) + C_{pl}(T_8 - T_9)] = h_{lv}(T_1) \quad (14)$$

Equation (14) enables determination of the minimum temperature difference at the pinch point:

$$\Delta T_{\min} = T_9 - T_1 = (T_8 - T_1) - \frac{\frac{\dot{m}_w}{\dot{m}_{ORC}} [C_{pv}(T_6 - T_7) + h_{lv}(T_7)] - h_{lv}(T_1)}{\frac{\dot{m}_w}{\dot{m}_{ORC}} C_{pl}} \quad (15)$$

On the other hand, if we regard the minimum temperature difference at pinch point as a parameter, then from equation (15) we can determine the ratio $\dot{m}_w / \dot{m}_{ORC}$. That reads:

$$\frac{\dot{m}_w}{\dot{m}_{ORC}} = \frac{h_{lv}(T_1)}{C_{pl}[(T_8 - T_1) - \Delta T_{\min}] - [C_{pv}(T_6 - T_7) + h_{lv}(T_7)]} \quad (16)$$

Knowledge of that quantity enables determination of the outlet temperature of the heating fluid T_{10} in ORC installation from (13), as:

$$T_{10} = \frac{[C_{pv}(T_6 - T_7) + h_{lv}(T_7) + C_{pl}T_8] - [C_{pORC}(T_1 - T_4) + h_{lv}(T_1)] \left(\frac{\dot{m}_w}{\dot{m}_{ORC}} \right)^{-1}}{C_{pl}} \quad (17)$$

In the considered case it is assumed that the point at which there is the minimum temperature difference between the heating fluid and the ORC working fluid is found on the liquid line of the heating fluid (after its condensation), (Fig. 4).

3. RESULTS

In order to show the performance of the described earlier mathematical model the calculations of final temperature of the source as well as mass flow ratio for two cases, namely the single phase fluid as well as the phase changing fluid have been performed. The obtained results of calculations are presented in the form of distributions of the ratio of the flow rate of heating

fluid to the working fluid in ORC installation as well as outlet temperature of the heat source, both in terms of temperature before the turbine.

3.1. ORC heating using low temperature single phase fluid

In the first case considered is the ORC heated by the stream of hot water with inlet temperature $T_6=90^\circ\text{C}$ and ethanol as working fluid. Properties of ethanol were taken from Refprop 9.0 [12].

Figure 5 shows the results of calculations of the ratio of the heating fluid flow rate to the flow rate of working fluid in ORC installation in function of temperature before turbine for the assumed minimum pinch point temperature difference equal to ΔT_{\min} , treated as a parameter. It can be immediately seen from that figure that the ratio of the flow rate of heating fluid to the one in ORC installation, namely $\dot{m}_w / \dot{m}_{ORC}$ is a function of ΔT_{\min} at the pinch point. In this case we can notice a very significant increase of the ratio $\dot{m}_w / \dot{m}_{ORC}$ with increasing temperature before the turbine, T_1 , as well as with increasing ΔT_{\min} . The rise of that ratio is very significant in both respects. For example, in order to obtain evaporation temperature in ORC equal to $T_1=80^\circ\text{C}$ with $\Delta T_{\min}=5^\circ\text{C}$ the ratio of the flow rate of water to the flow rate of ethanol must be equal to over forty. Even higher values of that ratio should be justified when the values of $\Delta T_{\min}>5^\circ\text{C}$. Hence, in case of greater ΔT_{\min} much lower evaporation temperatures are feasible, but leading also to lower values of $\dot{m}_w / \dot{m}_{ORC}$ ratio. If we consider for example the evaporation temperature of 70°C then the smallest ratio $\dot{m}_w / \dot{m}_{ORC}$ is obtained for the smallest value of $\Delta T_{\min}=5^\circ\text{C}$. In that case the ratio of flowrates for $\Delta T_{\min}=5^\circ\text{C}$ is about ten, whereas for $\Delta T_{\min}=15^\circ\text{C}$ it is over forty, respectively. Fig. 6 shows the results of calculations



of outlet temperature T_{10} of heating fluid in function of temperature before the turbine for different temperatures of evaporation of ethanol. The analysis of Figure 6 gives us the temperature limit to which we can cool down our heat source at a specified evaporation temperature. In the case of selecting the high evaporation temperature of ORC working fluid (say 75°C , as our heat source is assumed at inlet temperature of 90°C) we can reduce the temperature of the heat source only by about 6K for $\Delta T_{\min}=5^{\circ}\text{C}$. If a higher value of pinch point temperature difference is assumed, say $\Delta T_{\min}=10^{\circ}\text{C}$, then the heat source temperature can only be reduced by less than 2°C . That is regarded as the inefficient and uneconomic use of the available heat source. In case of exploring for example the waste heat from some industrial process that is unacceptable. Another drawback, which is apparent from recalling the data from Fig. 5, is that the \dot{m}_w/\dot{m}_{ORC} required for achieving this task (high evaporation temperature) is also excessively large. Maximum reduction of the heat source temperature that can be obtained is the one corresponding to the lowest evaporation pressure (temperature) in ORC, in our case, considered as that related to temperature 50°C . Assuming that the minimum temperature difference at the pinch point should not be less than 5°C we obtain the lowest attainable temperature of our heating medium equal to $T_{10} = 67^{\circ}\text{C}$. In case of higher ΔT_{\min} the outlet source temperatures will be higher, yielding 71°C at $\Delta T_{\min}=10^{\circ}\text{C}$ and 74°C at $\Delta T_{\min}=15^{\circ}\text{C}$, respectively. At such low evaporation temperatures, on the other hand, the smallest values of thermal efficiency of ORC will be obtained. Hence we should notice that at high evaporation temperatures of ORC working fluid the source remains unexploited to a full potential, but thermal efficiencies of the cycle are higher, whereas satisfactory exploitation of the heat source leads to smaller thermal efficiencies of the cycle.

The presented method of fitting the heat source to the ORC should convince the reader that the issue of the finite capacity of heat source is a very important aspect of the ORC



installation design. Presented simple analytical model returns quickly and efficiently the extent of temperature to which the available heat source can be explored at assumed evaporation conditions in ORC and the assumed values of pinch point temperature difference. The model is general and can be applied to any fluid combination and therefore should be a useful tool in quick scanning in pre-selection of working fluids for ORC receiving heat from the fluid regarded as limited heat source.

The calculations show that the value of evaporation temperature of the working fluid T_1 is coupled with the ratio of the mass flow rates of heating fluid flow to ORC working fluid as well as with the heating fluid outlet temperature T_{10} . This has also bearing on exergy losses in the evaporator which are minimized in case of small mean temperature differences between the heat source and the working fluid. Such situation is present at small ΔT_{\min} .

Properly selected evaporation temperature in the ORC installation should be determined from the optimization criterion. One of them is that the logarithmic mean temperature difference in evaporator should be minimized, ie:

$$LMTD \rightarrow \min \quad (18)$$

Variation of the logarithmic mean temperature difference as a function of the temperature of working fluid before turbine for different temperatures of evaporation of ethanol and hot water inlet temperature $T_6=90^\circ\text{C}$ is shown in Figure 7. A decrease of the LMTD is observed with increasing evaporation temperature in ORC. The chart shows that the LMTD for the given evaporation temperature of the working fluid in the ORC system decreases with the increase of the pinch point temperature difference ΔT_{\min} . The gradient of the change of LMTD increases with increasing the evaporation temperature of the working fluid. Obtained values of thermal efficiency are shown in Fig. 8.

To show the influence of different evaporation temperatures on the ORC thermal efficiency and produced power the case study can be considered of the plant with evaporator capacity of 5MW. For all calculations it has been assumed that the heat source inlet temperature is 90°C. Four different evaporation temperatures were considered. The results with corresponding values of thermal efficiency are presented in Table 1. The efficiency and power generated in the cycle are a function of the ratio of mass flow rate of hot water to the mass flow rate associated with the working fluid in ORC installation and they decrease with reduction of evaporation temperature. As a result we find that in case of required evaporation temperatures of 80°C the production of electricity in the ORC installation is the best. In such case there will be however excessive pumping power involved in circulation of heating fluid. We can notice also that the water outlet temperature T_{10} is relatively high for the case of highest evaporation temperature of working fluid and it assumes lower values for lower evaporation temperatures, indicating in such way a better heat utilization.

3.2. ORC heating using high temperature single phase fluid-thermal oil

In the second considered example the heat supply is provided from the hot thermal oil. It is assumed in calculations that the oil inlet temperature is $T_6=310^\circ\text{C}$, whereas the condensation temperature in ORC is 100°C. In such arrangement, the heat removed from condenser can be used for other applications such as for example central heating purposes. In the present study three possible working fluids in ORC are considered, namely MDM and D4, and dodecane. The cycles are considered as subcritical. In Table 2 presented is a brief characteristic of



thermophysical properties of considered working fluids. The data with properties are taken from Refprop9.0 [12].

Fig. 9-11 show the results of calculations of the ratio of flow rate of heating fluid to the flow rate of working fluid in ORC installation, $\dot{m}_w / \dot{m}_{ORC}$, against temperature before turbine (working fluid evaporation temperature). Calculations have been accomplished for different evaporation temperatures. In Fig. 9 presented are the distributions of mass flow rate ratio in function of different values of pinch point temperature differences, ΔT_{min} . As can be noticed, the least ratio for ORC installation is required for the case of MDM as working fluid, followed by D4 and finally dodecane. It is also directly apparent that the ratio of flow rates of thermal oil to ORC working fluid is a function of the minimum temperature difference at the pinch point. The greater the pinch point temperature gets the greater amount of working fluid is required. In the considered case, however, the values of that ratio are significantly smaller than in the case when water was considered as heating fluid, presented in the former section. Fig. 12, 13 and 14 show the outlet temperatures of thermal oil T_{10} in function of temperature of vapor before the ORC turbine. If we assume a relatively high evaporation temperature of working fluid, which is identical for all fluids, for example, $T_1=280^\circ\text{C}$, then the outlet temperature T_{10} is lowest for $\Delta T_{min}=5^\circ\text{C}$. In case of other fluids the source of heat will be cooled to the smaller extent. It must be also borne in mind that in case of a large temperature difference at pinch point there will be required a greater flow rate of thermal oil, which is directly related to the extra pumping power. The amount of required heating oil is relatively large in case of D4 and dodecane in comparison to MDM, which required at least twice less of that oil. In such case, when the flow rate ratio is too excessive the decrease of the evaporation temperature should be considered, equivalent to reduction of temperature before the turbine. Obviously that leads to the reduction of the ORC efficiency, but considering the

extra power required for thermal oil circulation the net output of the installation as a whole could be greater. Analysis of Fig. 12-14 indicates the attainable outlet temperatures of thermal oil related to evaporation temperature T_1 and the minimum pinch point temperature difference ΔT_{\min} . In case of high evaporation temperatures and small pinch point temperatures we can reduce temperature of thermal oil only by up to 40°C. However, with increasing pinch temperature the possible drop of outlet temperature of thermal oil is much smaller. Much higher temperature drops of thermal oil can be expected in case of lower evaporation temperatures. Hence we can notice that by changing the evaporation temperature of working fluid in ORC installation we can influence the amount of required flow rate of thermal oil in installation and its outlet temperature T_{10} . In this way we can influence the mean temperature difference in the evaporator and hence the efficiency. Variation of the logarithmic mean temperature difference in function of pinch point temperature difference for different evaporation temperatures of working fluid is presented in Fig. 15-17 for MDM, D4 and dodecane respectively. It stems from these charts that LMTD, corresponding to a particular evaporation temperature, increases with increasing pinch point temperature difference. The gradient of LMTD **distribution curves** rises with decreasing evaporation temperature. It is apparent that the greater the pinch point temperature difference and the lower the evaporation temperature **is**, the greater is the logarithmic mean temperature difference. LMTD exhibits also a decreasing tendency with increasing evaporation temperature of working fluid vapor before the turbine. **The results of the calculations of the ORC thermal efficiency are presented in Fig. 18.** Again the highest values are obtained for dodecane; however differences with other fluids are not significant.

3.3. Heat supply by phase changing fluid

In case of the heating fluid condensing whilst supplying heat to ORC the following values of parameters have been assumed. The inlet temperature of the heating fluid is $T_6=228^\circ\text{C}$ and $p_6=2.52\text{bar}$, which corresponds to the typical parameters of the steam from numerous industrial processes. In the considered case the condensation temperature corresponds to pressure p_6 and yields $T_7=T_6=127.7^\circ\text{C}$. The ethanol has been considered as a working fluid. In figures 19-22 presented are the distributions of the ratio of flow rates of steam to working fluid in ORC installation (Fig. 19), outlet temperature of heating medium T_{10} which can be attained by specified cooling conditions (Fig. 20) and finally the logarithmic mean temperature difference (Fig. 21). Presented is also thermal efficiency (Fig. 22).

It can be noticed from the analysis of Fig. 19 that the ratio of flow rate of steam to the flow rate of working fluid in ORC installation \dot{m}_w/\dot{m}_{ORC} is a function of temperature difference at pinch point. The ratio is decreasing with decreasing temperature T_1 . The flow rate of heating fluid is not as large as in the case of supplying heat using the single phase medium. It amounts to about 33% of the amount of working fluid in ORC installation. It stems from the chart that the lower the ΔT_{\min} the lower is the required flow rate of heating medium. It also stems from the calculations that the higher is temperature of vapor before the turbine the less of heating fluid (condensing steam) is required to heat the working fluid in ORC installation. These conclusions are also confirmed by results of calculations presented in Fig. 20, where distributions of the heating fluid outlet temperatures are presented. At lower temperatures T_1 the heat source features higher outlet temperatures. In Fig. 21 presented is the variation of a logarithmic mean temperature difference against T_1 . Analysis of that chart enables to notice the fact that the greater the vapor temperature of working fluid before the turbine is and the

greater the temperature difference at pinch point is then the logarithmic mean temperature difference is greater, indicating not a full utilization of the heat potential.

4. CONCLUSIONS

In the current paper, two cases of supplying heat to ORC installation have been discussed. First one is by using the single phase fluid and the other one by the phase changing fluid. Both cases have been modeled using the relevant mathematical expressions of energy balance, which enable determination of the temperature of the heating fluid after its use, the ratio of flow rates of the heating fluid to the working fluid in ORC installation and finally the logarithmic mean temperature difference in the evaporator.

In case of supplying the ORC systems with a single phase heat source the LMTD for a given evaporation temperature of working fluid in ORC installation increases with the increase of temperature difference at pinch point as well as decreasing the evaporation temperature. It must also be noticed that LMTD decreases with decrease of temperature of working fluid before the turbine. Hence the conclusion is that the lower the evaporation temperature is, the smaller is the required heat exchanger area, whereas at higher evaporation temperatures, and therefore the cycle efficiencies, the heat exchanger area will be greater. Summarizing the results of calculations for the case of heating the working fluid by means of the single phase heat source we can conclude that the ORC, where temperature of working fluid prior to the turbine is $T_1=50^{\circ}\text{C}$, can attain the highest temperature drop of the heating fluid. In the considered case the heating fluid reaches at outlet the temperature $T_{10}=67.5^{\circ}\text{C}$. That means



that the heat from heating fluid is very efficiently **utilized**, however the thermodynamic efficiency of the Rankine cycle is then very low. Higher evaporation temperatures require very high flow rates of heat carrier and the heat source is not efficiently cooled. **Reasonable** utilization of low-temperature waste heat is a great challenge for the foreseeable future **for ORC**.

Presented **results of** calculations should convince the reader to the fact that the issue of variation of heat source temperature is a very important aspect of designing the ORC installation with external fluid supplying the system with heat. Presented simple, **analytical** relations enable to adjust the appropriate flow rates of the working fluid in ORC installation as well as of heating fluid to the required temperature drop of the heat source. On the basis of that model and **subsequent** incorporation of exergy analysis the thermodynamic criterion for appropriate selection of evaporation temperature and the flow rates of used fluids can be established. It stems from the accomplished calculations that by changing evaporation temperature of working fluid T_1 we can change the ratio of flow rates $\dot{m}_w / \dot{m}_{ORC}$ in ORC installation as well as the outlet temperature of heating fluid T_{10} .

In the case of heating the ORC installation by means of the fluid changing its phase the ratio of flow rates of heating fluid to the working fluid in ORC $\dot{m}_w / \dot{m}_{ORC}$ is **also** a function of temperature difference at pinch point. In this case with decreasing temperature T_1 (temperature of working fluid vapor before the turbine) that effect is getting smaller. The flow rate of steam must not be in that case a large as in the case of single phase heating fluid. In this case it amounts to about 33% of that of the fluid in ORC installation. The smaller the ΔT_{min} the smaller flow rate of heating medium to ORC is required.

ACKNOWLEDGEMENT

The results presented in this paper were obtained from research work co-financed by the National Centre of Research and Development in the framework of Contract SP/E/1/67484/10 – Strategic Research Programme – Advanced technologies for obtaining energy: Development of a technology for highly efficient zero-emission coal-fired power units integrated with CO₂ capture.

REFERENCES

1. Mikielwicz D., Mikielwicz J., Utilisation of bleed steam heat to increase the upper heat source temperature in low-temperature ORC, *Archives of Thermodynamics*, vol. 3., 2011.
2. Liu B-T, Chien K-H, Wang C-C., Effect of working fluids on organic Rankine cycle for waste heat recovery, *Energy* 29 (2004) 1207–1217.
3. Saleh B., Koglbauer G., Wendland M., Fischer J., Working fluids for low-temperature organic Rankine cycles, *Energy* 32 (2007) 1210–1221.
4. Lakew A.A., Bolland O., Working fluids for low-temperature heat source, *Applied Thermal Engineering* 30 (2010) 1262–1268.
5. Khennich, M.; Galanis, N. Thermodynamic analysis and optimization of power cycles using a finite low-temperature heat source, *Int. J. Energy Res.* 2012; 36:871–885.
6. Hettiarachchi H.D, Golubovic M., Worek W.M., Ikegami Y., Optimum design criteria for an Organic Rankine cycle using low-temperature geothermal heat sources, *Energy* 32 (2007) 1698–1706.
7. Quoilin S., Lemort V., Lebrun J., Experimental study and modeling of an Organic Rankine Cycle using scroll expander, *Applied Energy* 87 (2010) 1260–1268.

8. Astolfi M., Xodo L., Romano M.C., Macchi E., Technical and economical analysis of a solar–geothermal hybrid plant based on an Organic Rankine Cycle, *Geothermic* 40 (2011) 58–68.
9. Tchanche B.F., Papadakis G., Lambrinos G., Frangoudakis A., Fluid selection for a low-temperature solar organic Rankine cycle, *Applied Thermal Engineering* 29 (2009) 2468–2476.
10. Zhou N., Wang X., Chen Z., Wang Z., Experimental study on Organic Rankine Cycle for waste heat recovery from low-temperature flue gas, *Energy* 55 (2013) 216-225.
11. El-Emam R.S., Dincer I., Exergy and exergoeconomic analyses and optimization of geothermal organic Rankine cycle, *Applied Thermal Engineering* 59 (2013) 435-444.
12. NIST Reference Fluid Thermodynamic and Transport Properties – REFPROP v.9.0, National Institute of Standards, 2010.

Figure captions:

Fig. 1. Scheme of the wet ORC without regeneration.

Fig. 2. Scheme of the dry ORC with regeneration.

Fig. 3. Schematic of heat supply to the ORC installation by means of the single phase fluid, $H=m h$.

Fig. 4. A schematic of heat supply to the ORC by means of the fluid changing phase, $H=m h$.

Fig. 5. The ratio of mass flow rates m_w/m_{ORC} as function of temperature before the turbine for ethanol as working fluid; inlet hot water temperature $T_6=90^\circ\text{C}$.

Fig. 6. Outlet temperature T_{10} of hot water supplying heat to ORC installation as function of temperature before the turbine for ethanol as working fluid; inlet hot water temperature $T_6=90^\circ\text{C}$.

Fig. 7. Logarithmic mean temperature difference as function of temperature before the turbine for ethanol as working fluid; inlet hot water temperature $T_6=90^\circ\text{C}$.

Fig. 8. Thermal efficiency of ORC installation as function of temperature before the turbine for ethanol as working fluid; inlet hot water temperature $T_6=90^\circ\text{C}$.

Fig. 9. The ratio of mass flow rates \dot{m}_w/\dot{m}_{ORC} as function temperature before turbine for MDM as working fluid; inlet temperature of thermal oil $T_6=310^\circ\text{C}$.

Fig. 10. The ratio of mass flow rates \dot{m}_w/\dot{m}_{ORC} as function temperature before turbine for D4 as working fluid; inlet temperature of thermal oil $T_6=310^\circ\text{C}$.

Fig. 11. The ratio of mass flow rates \dot{m}_w/\dot{m}_{ORC} as function temperature before turbine for dodecane as working fluid; inlet temperature of thermal oil $T_6=310^\circ\text{C}$.

Fig. 12. Outlet temperature T_{10} of thermal oil as function of temperature before turbine for MDM as working fluid; inlet temperature of thermal oil $T_6=310^\circ\text{C}$.

Fig. 13. Outlet temperature T_{10} of thermal oil as function of temperature before turbine for D4 as working fluid; inlet temperature of thermal oil $T_6=310^\circ\text{C}$.

Fig. 14. Outlet temperature T_{10} of thermal oil as function of temperature before turbine for dodecane as working fluid; inlet temperature of thermal oil $T_6=310^\circ\text{C}$.

Fig. 15. Logarithmic mean temperature difference as function of temperature before turbine for MDM as working fluid; inlet temperature of thermal oil $T_6=310^\circ\text{C}$.

Fig. 16. Logarithmic mean temperature difference as function of temperature before turbine for D4 as working fluid; inlet temperature of thermal oil $T_6=310^\circ\text{C}$.

Fig. 17. Logarithmic mean temperature difference as function of temperature before turbine for dodecane as working fluid; inlet temperature of thermal oil $T_6=310^\circ\text{C}$.

Fig. 18. Thermal efficiency of ORC installation as function of temperature before the turbine for different working fluids; inlet temperature of thermal oil $T_6=310^\circ\text{C}$.

Fig. 19. The ratio of mass flow rates $\dot{m}_w / \dot{m}_{ORC}$ as function of temperature before turbine for different temperatures of evaporation of ethanol; inlet temperature of hot water $T_6=90^\circ\text{C}$.

Fig. 20. Outlet temperature T_{10} of hot water heating the ORC installation as function of temperature before turbine for different evaporation temperatures of ethanol; inlet temperature of hot water $T_6=90^\circ\text{C}$.

Fig. 21. Logarithmic mean temperature difference as function temperature before the turbine for different evaporation temperatures of ethanol; inlet temperature of hot water $T_6=90^\circ\text{C}$.

Fig. 22. Thermal efficiency of ORC installation as function of temperature before the turbine for ethanol; inlet temperature of hot water $T_6=90^\circ\text{C}$.



Table captions

Table 1. Results of calculations for the stand alone ORC system heated from the single phase heat source having temperature 90°C. Heat added to evaporator equal 5MW, condensation temperature 40°C.

Table 2. Characteristics of considered fluids.

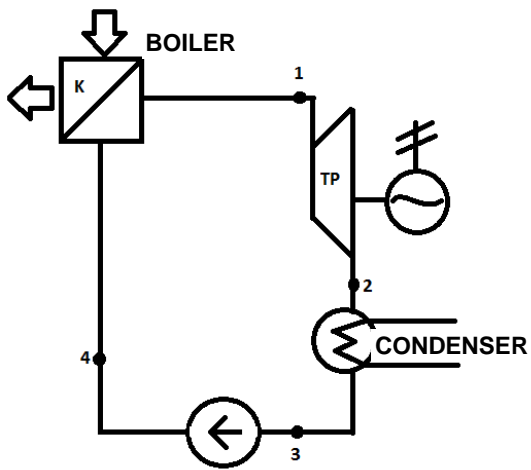

Fig. 1. Schematic of the wet ORC without regeneration

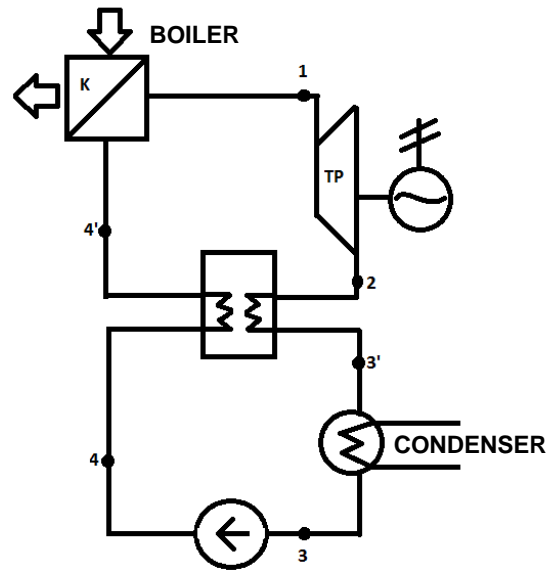

Fig. 2. Schematic of the dry ORC with regeneration

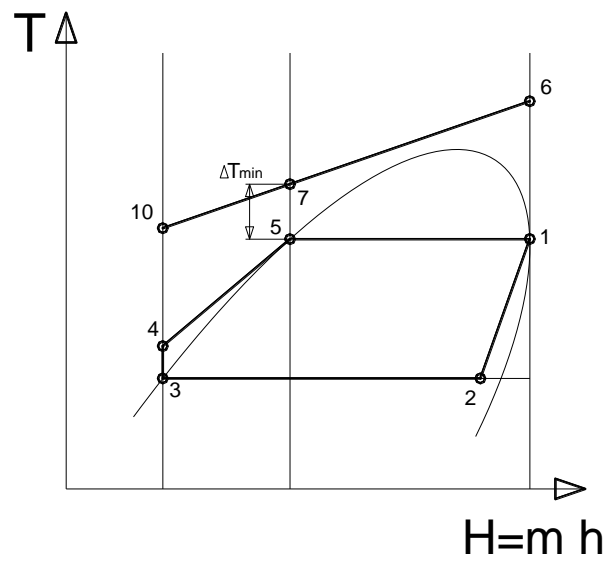

Fig. 3. Schematic of heat supply to the ORC installation by means of the single phase fluid.

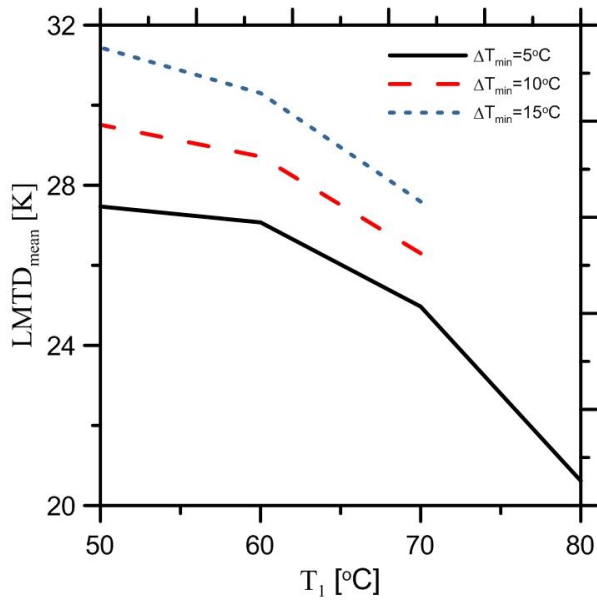

Fig. 7. Logarithmic mean temperature difference as function of temperature before the turbine for ethanol as working fluid; inlet hot water temperature $T_6=90^\circ\text{C}$.

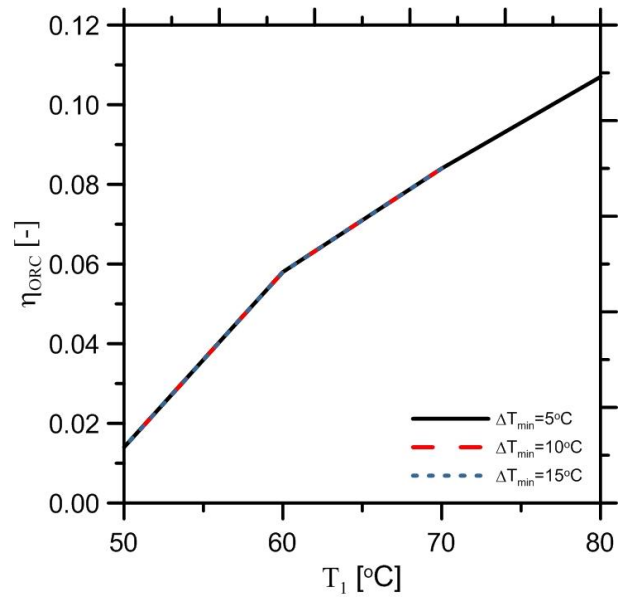

Fig. 8. Thermal efficiency of ORC installation as function of temperature before the turbine for ethanol as working fluid; inlet hot water temperature $T_6=90^\circ\text{C}$.

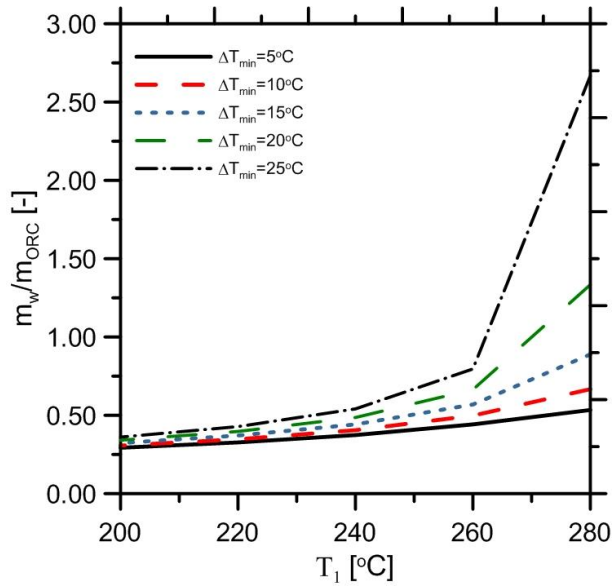

Fig. 9. The ratio of mass flow rates $\dot{m}_w / \dot{m}_{ORC}$ as function temperature before turbine for MDM as working fluid; inlet temperature of thermal oil $T_6=310^\circ\text{C}$.

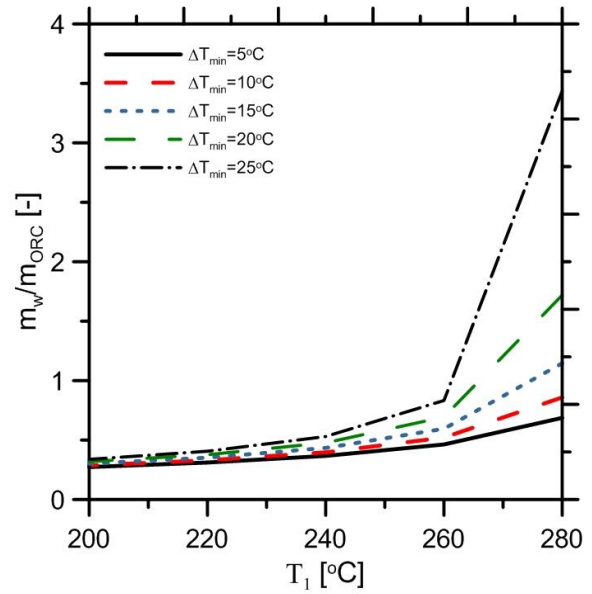

Fig. 10. The ratio of mass flow rates $\dot{m}_w / \dot{m}_{ORC}$ as function temperature before turbine for D4 as working fluid; inlet temperature of thermal oil $T_6=310^\circ\text{C}$.

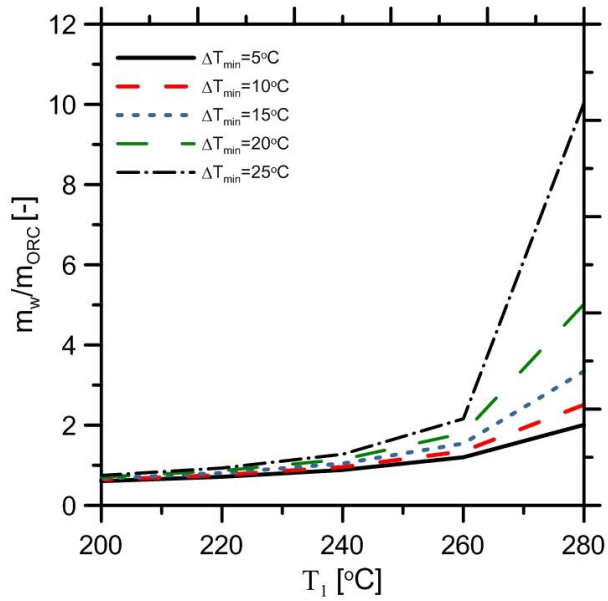

Fig. 11. The ratio of mass flow rates $\dot{m}_w / \dot{m}_{ORC}$ as function temperature before turbine for dodecane as working fluid; inlet temperature of thermal oil $T_6=310^{\circ}\text{C}$.

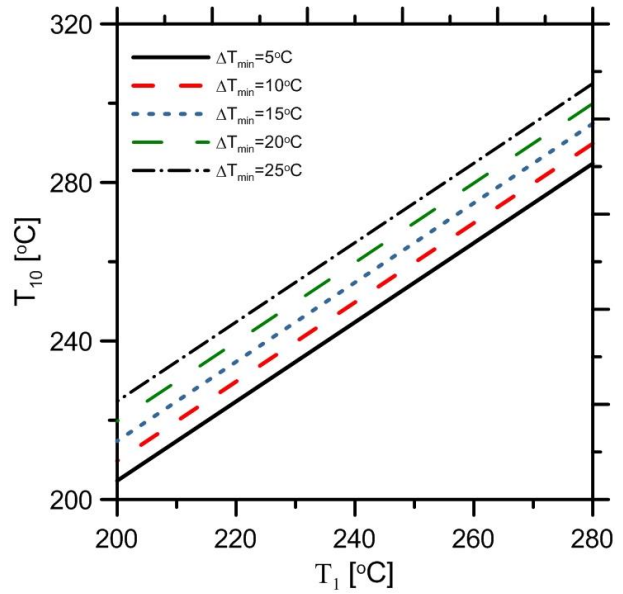

Fig. 12. Outlet temperature T_{10} of thermal oil as function of temperature before turbine for MDM as working fluid; inlet temperature of thermal oil $T_6=310^{\circ}\text{C}$.

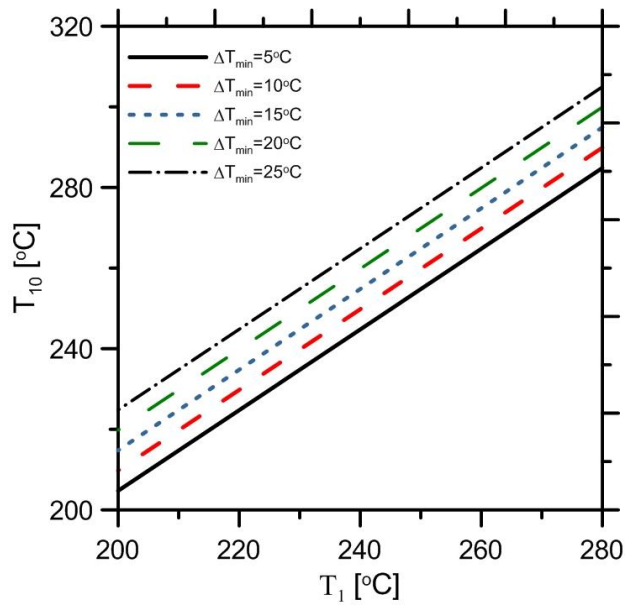

Fig. 13. Outlet temperature T_{10} of thermal oil as function of temperature before turbine for D4 as working fluid; inlet temperature of thermal oil $T_6=310^\circ\text{C}$.

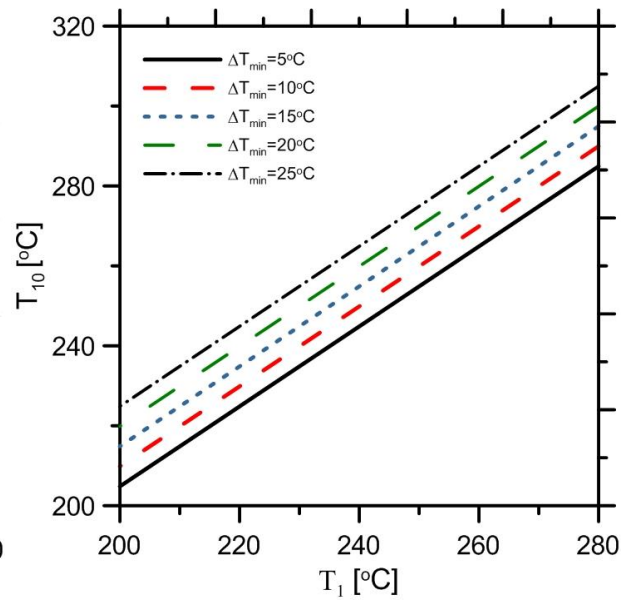

Fig. 14. Outlet temperature T_{10} of thermal oil as function of temperature before turbine for dodecane as working fluid; inlet temperature of thermal oil $T_6=310^\circ\text{C}$.

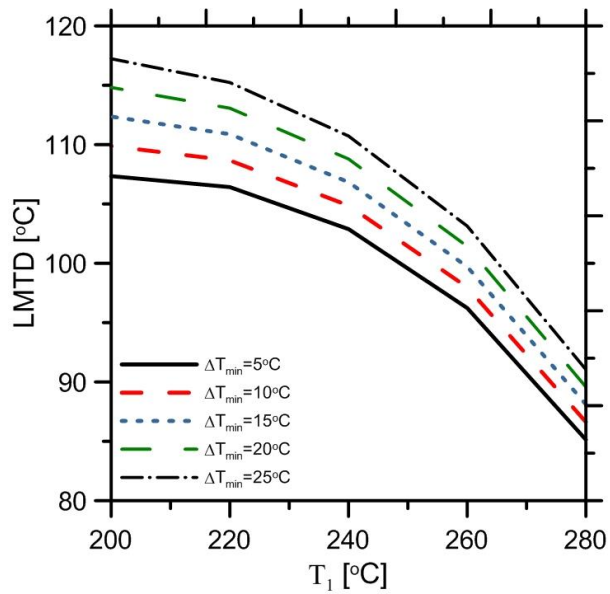

Fig. 15. Logarithmic mean temperature difference as function of temperature before turbine for MDM as working fluid; inlet temperature of thermal oil $T_6=310^\circ\text{C}$.

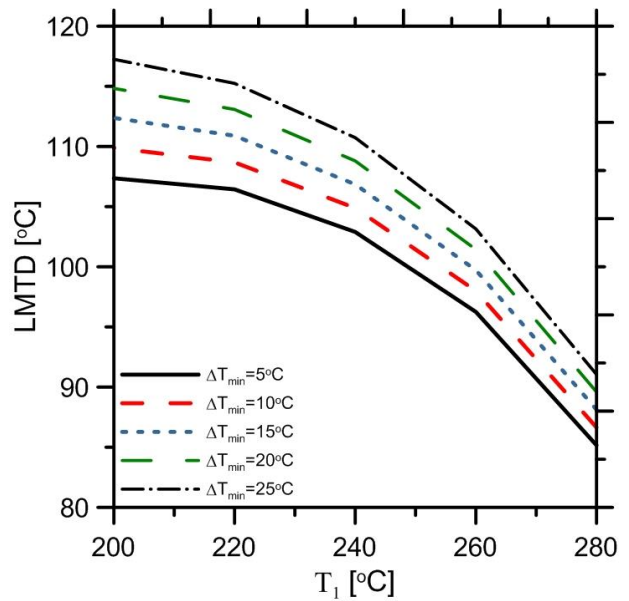

Fig. 16. Logarithmic mean temperature difference as function of temperature before turbine for D4 as working fluid; inlet temperature of thermal oil $T_6=310^\circ\text{C}$.

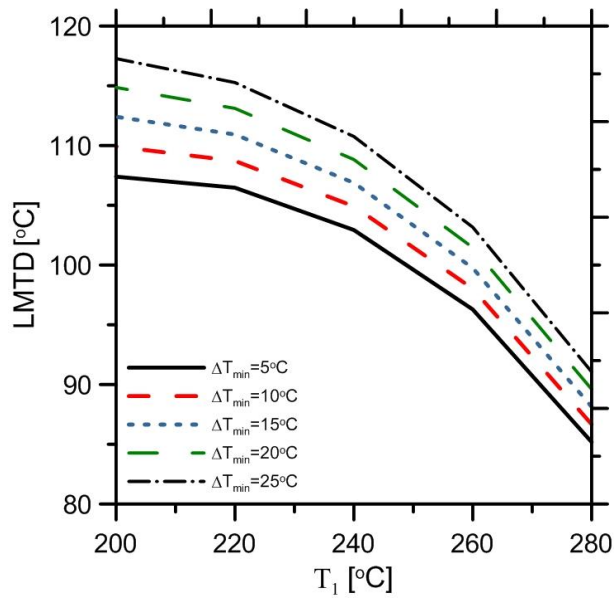

Fig. 17. Logarithmic mean temperature difference as function of temperature before turbine for dodecane as working fluid; inlet temperature of thermal oil $T_6=310^\circ\text{C}$.

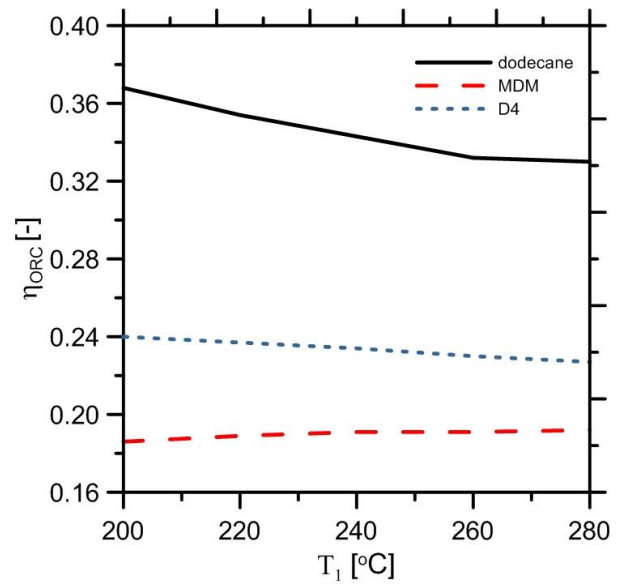

Fig. 18. Thermal efficiency of ORC installation as function of temperature before the turbine for different working fluids; inlet temperature of thermal oil $T_6=310^\circ\text{C}$.

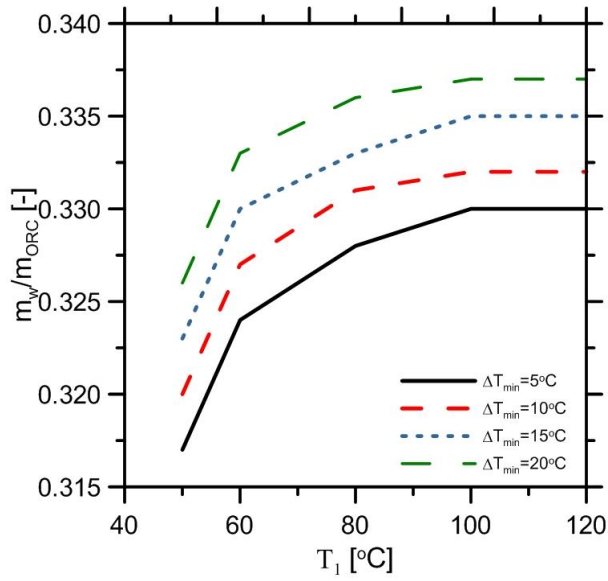

Fig. 19. The ratio of mass flow rates $\dot{m}_w / \dot{m}_{ORC}$ as function of temperature before turbine for different temperatures of evaporation of ethanol; inlet temperature of hot water $T_6=90^\circ\text{C}$.

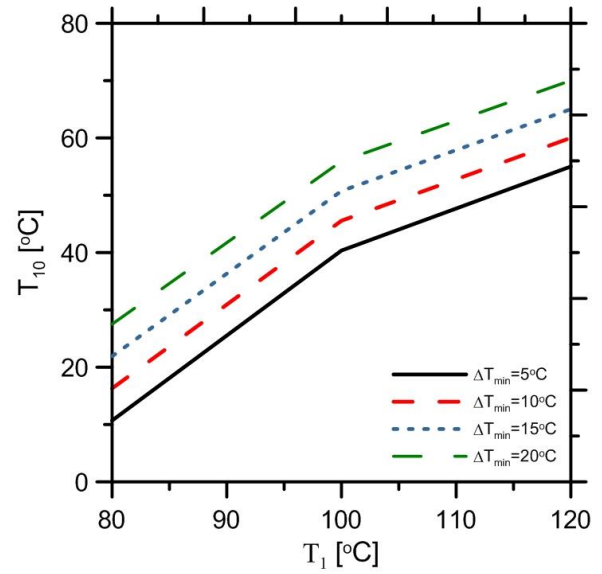

Fig. 20. Outlet temperature T_{10} of hot water heating the ORC installation as function of temperature before turbine for different evaporation temperatures of ethanol; inlet temperature of hot water $T_6=90^\circ\text{C}$.

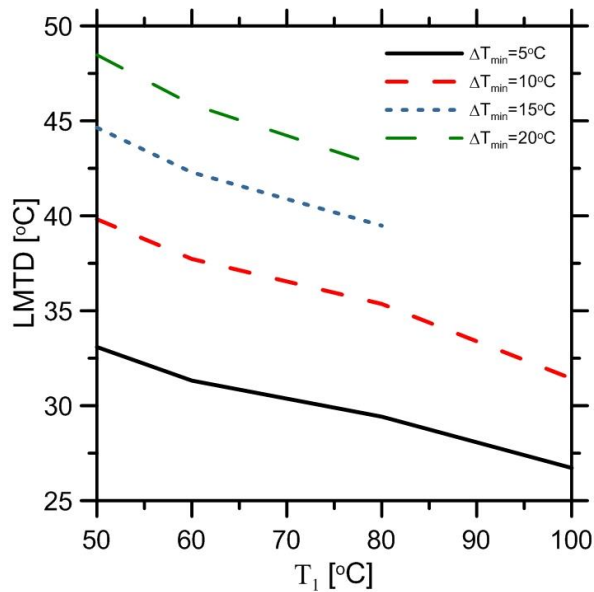

Fig. 21. Logarithmic mean temperature difference as function temperature before the turbine for different evaporation temperatures of ethanol; inlet temperature of hot water $T_6=90^{\circ}\text{C}$.

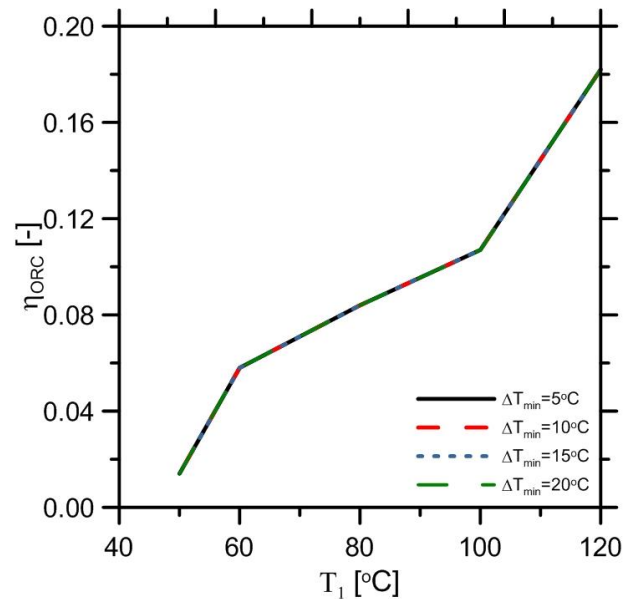

Fig. 22. Thermal efficiency of ORC installation as function of temperature before the turbine for ethanol; inlet temperature of hot water $T_6=90^{\circ}\text{C}$.

Table 1. Results of calculations for the stand alone ORC system heated from the single phase heat source having temperature 90°C . Heat added to evaporator equal 5MW, condensation temperature 40°C .

		Waste water inlet temperature/boiling temperature T_1			
		90/80	90/70	90/60	90/50
Efficiency of ORC system	-	0.107	0.084	0.058	0.014
Mass flow rate in waste heat water	kg/s	216.29	73.50	44.87	32.55
Electrical power of ORC	kW	552.66	425.9	292.11	66.87
Water outlet temperature T_{10}	$^{\circ}\text{C}$	84.50	73.76	63.40	53.34

Table 2. Characteristics of considered fluids.

Fluid	M	p_{cr}	T_{cr}	$p_{cond}(100^{\circ}C)$
	kg/kmol	bar	$^{\circ}C$	bar
D4	296.62	13.32	313.35	0.086688
Dodecane	170.33	18.17	384.95	0.020269
MDM	236.53	14.15	290.94	0.199740