

Case study of masts damage of the sail training vessel POGORIA.

1. Introduction.

At the entrance to the Gulf of Finland (Baltic Sea), Polish barquentine Pogoria with 50 crewmembers onboard had an accident during Tall Ships Race in the first half of July 2009. All three masts were broken and destroyed both the running and standing riggings (fig. 1). Any significant consequences for the crewmembers did not come into existence.



Fig. 1. The snapshot of Pogoria made just after accident

Nevertheless, this accident focused considerable attention of the people and media interested in sail training. They formulated the following questions related to causes of mast fracture:

- source of releasing so huge destructive forces,
- factors triggering off ‘domino effect’,
- damage explanation of all mast which should be the strongest from the entire chain of sail propulsion: sails-running riggings-standing riggings-mast.

To explain of all aspects of the mentioned accident, Marine Chambers in Gdynia has begun investigation. It is the Polish legal institution carry out monitoring and analyzing of marine

accidents from the navigational safety point of view. Their verdict did not lay the blame on both the crew and ship-owner.

Nevertheless, answers for such formulated questions became significant and urgent for persons, who are permanently involved in the field of sail training. So, they tried to explain all aspects of aroused doubts.

This paper deals with fundamental circumstances of the occurred accident. Particularly, a process of the mast destruction, analysis of mast crack places, and the structural and technological causes of the mast weakening are presented.

2. Accident cases of sailing vessels.

In the last years, we can observe the increased interest to the sail propulsion of many kind of vessels, including trade vessels [1]. At the present time, this kind of propulsion is mainly used in training, touristic and research vessels. In recent times, we can observe the enlarged attention to the sea tourism. Shipowner competition in this area forces to search the new attractive offers for customers of passenger ships. Shipowners have begun to build large touristic sailing vessels. As a rule, old sailing vessels were altered and adapted to passenger purposes. The modern design of large sailing vessels with the automated service of sails came up on many seas. Since the eightieth years of the last century, tens of large sailing vessels have been built.

Races organized once a year by Sail Training International are events most dynamically developed in this area. These races, well-known under the name of Tall Ships Races, group the most beautiful sailing vessels from the whole world. The races of the largest sailing vessels making up 'A' class are the most spectacular. Relying on the wind strength and own sailing skills, crews of such tall ships compete between each other, as it taken place during time of the legendary tea clippers.

As in every homogeneous group of ships, sailing vessels are endangered to various misfortunes, including incidents with human victims, e.g. falls from rigs, man overboard. In majority, such incidents are connected with so-called human factor.

The sailing vessel stability losses make up a different group of incidents for example capsizing of STV Concordia. She went down off the Brazilian coast in middle of February 2010. All crew and passengers were rescued. According to relation of crewmembers, the main reasons of the accident were both the strong wind and the high waves. This sailing vessel had very similar parameters to Pogoria. Similarly accidents of tall ships happened earlier many times. Case studies of such accidents can be found in [3] and [4].

Coming back to the Pogoria accident, cases of mast damages on sailing vessels of such sizes are not known to the authors. At present time, several sailing vessels of the similar design and built by the same shipyard are in operation. Therefore, the complete explanation of this event causes is very important in order to avoid similar accidents in the future.

3. Description of destruction process course of masts.

The sailing vessel STS Pogoria is a barquentine. She has three masts, which are all fore and aft rigged, except the foremast which is fully-rigged and carries square sails. The wind strength was about 6 degrees in the Beaufort scale at the moment of the accident. Pogoria sailed a close-hauled course in relation to the wind direction and carried sails typical for such the weather conditions that is she had the full rig without a few sails namely course, main topgallant stay, main royal stay and main gaff-top sails – Fig.2.

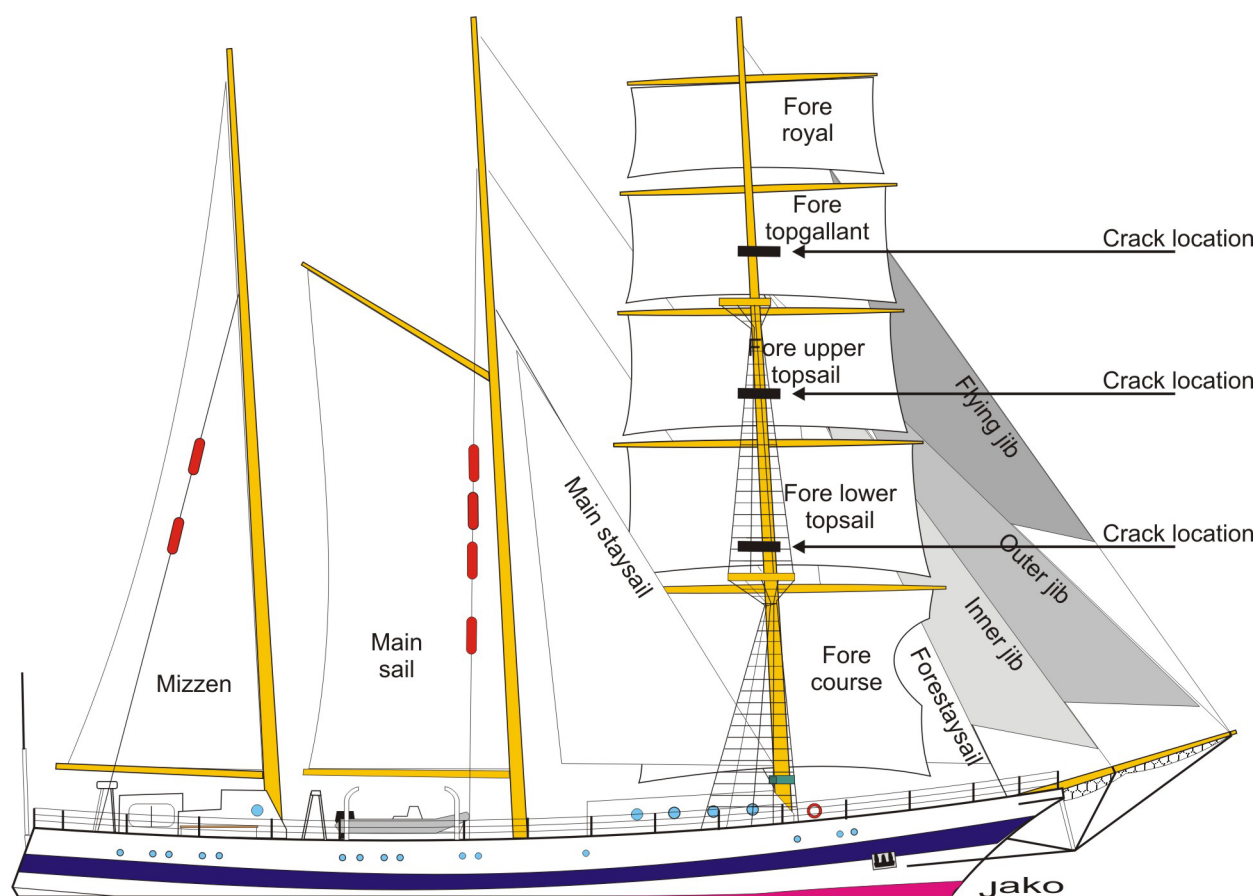

Fig.2. Pogoria sails set and foremast crack location in the moment of the accident

In our opinion, cooperation of two main factors was the direct cause of the fracture of foremast in its upper part:

- substantial weakness of the mast skin material in the determined cross-section,
- periodical action of dynamic strength triggered off by upper foremast sails called flying and outer jibs respectively.

Phenomenon explanation of the first factor will be presented in the further part of this paper. The second factor is connected with a way of sailing according to the close hauled course what means that Pogoria had the sails trimmed for sailing as close to the wind as possible. In the case of not very careful steering, this course can cause the sudden ‘down casting’ and ‘filling out’ upper triangular sails so-called stays. Several times repetition of such a maneuver triggered off the periodic dynamic forces which caused destruction of a skin material coherence of the foremast in its weakening place.

In the upper part of the broken foremast were accumulated the considerable potential energy. Its value sets up:

- a mass of the upper broken part of foremast together with two top yards (fore topgallant and royal), related rig and riggings,
- a location height of the of the fallen parts.

As a result of such destruction, the significant kinetic energy has been released by the fallen parts. This energy made the destructive work for the remaining masts, because their individual elements were connected together by means of the running and standing riggings.

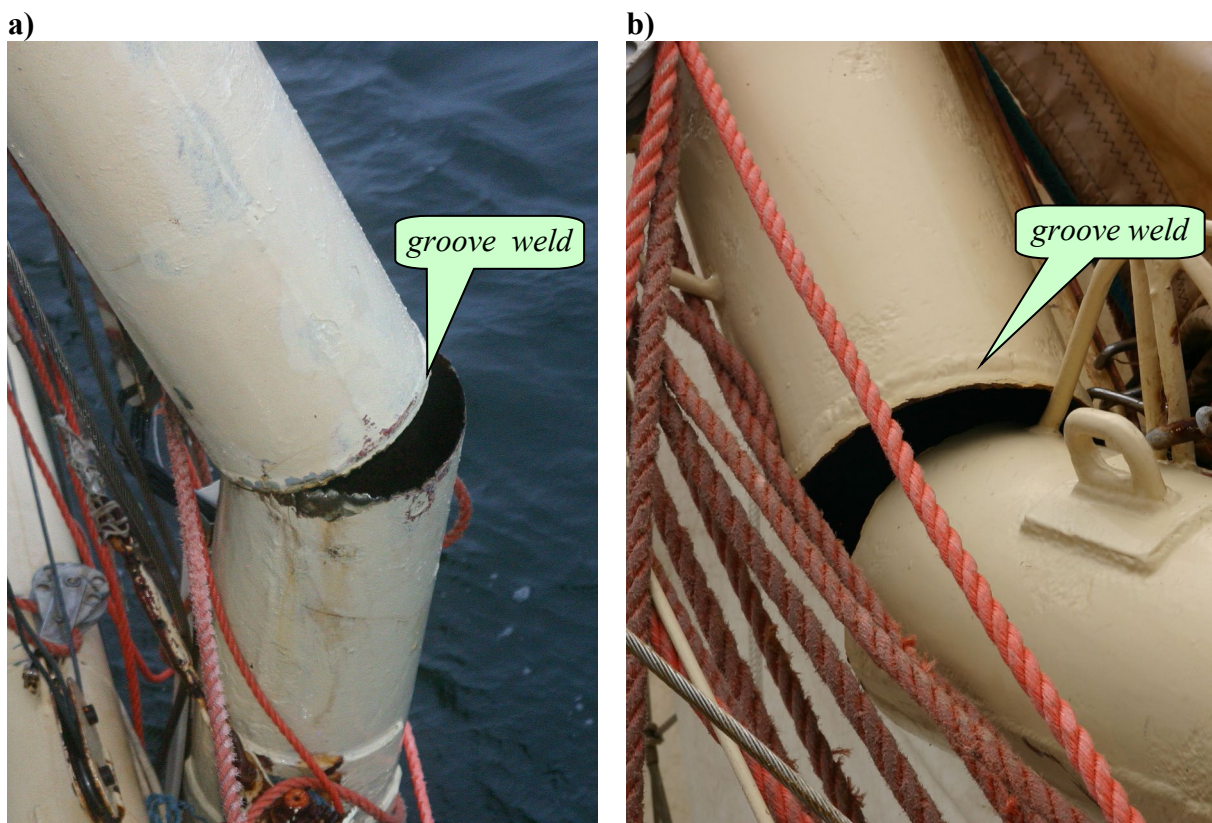

Fig. 3. Fracture examples of with marked butt welds: a) the foremast; b) mainmast.

Analysis carried out directly after the accident allowed us to unambiguously affirm, that:

- the skin material coherence of the foremast and mainmast was destroyed in three places,
- the mizzenmast was bent (deformed plastically) in about the half of its length,

- the material coherence of standing and running rigging was not violated, excepting a crack of the mounting eye welded to the top mizzenmast which kept the right after-back-stay,
- all weakening places were situated beneath the fusion welds connecting the individual parts of the foremast and mainmast (fig. 3a,b),
- fractures had the clear wedge sharpness at bottom parts of the broken tubes (fig. 4),
- fractures show signs of the characteristic stratification at upper parts of the broken tubes (fig. 5).

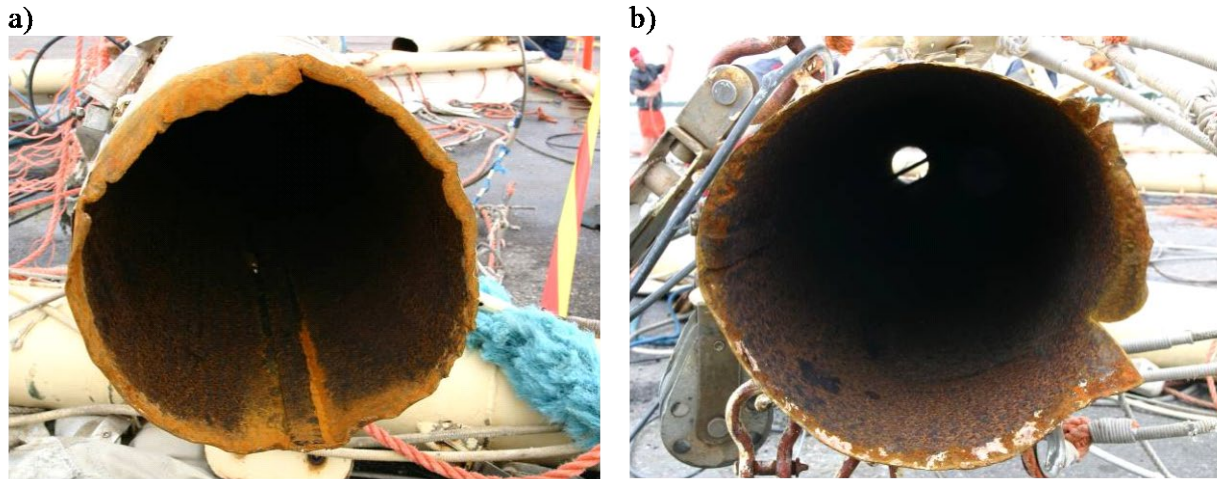

Fig. 4. Examples of the clear sharpness at the bottom parts of the broken tubes: a) foremast; b) mainmast.

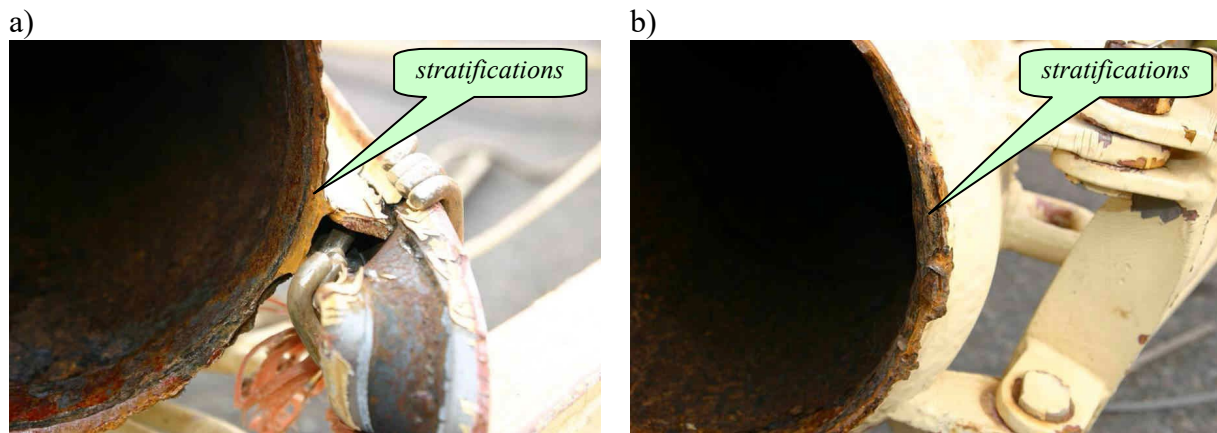

Fig. 5. Examples of the characteristic stratifications at the upper parts of the broken tubes: a) foremast; b) mainmast.

4. Destruction causes of masts.

1. *Structure of masts.*

Each of three damaged masts has the following structure (counting from a vessel deck):

- the mast column, span I (topmast), span II (topgallant mast),
- two attachment points, i.e. places for fixing of standing rigging.

All fundamental parts of masts were made of low-carbon constructional steel with carbon contents 0,19% and Mn, Si, P and S not exceeded standards requirements for steel category A.

Tests of masts material made after accident in laboratories of Gdansk University of Technology prove of the strength parameters as follows: $Re=242$ [MPa], $A_{10}=27\%$.

Structure of all masts was similar. The total length of the foremast was 28,5 m. It consisted of 11 tubes (circular segments) with diameters from 430 mm at its foot and 280 mm on its top. The length of tubes contained in the range from 2,0 m to 2,9 m. The total length of the mainmast was 29,9 m. It consisted of 11 tubes with diameters from 430 mm to 280 and lengths from 2,0 m to 2,9 m respectively. Additionally, the exhaust-pipe made of stainless steel was placed inside the mizzenmast. The skin of all tubes was prepared from rolled plates. Their thickness was respectively 7 mm for the column, 6 mm for the span I, and 5 mm for the span II. Each of tubes was formed for one sheet metal by rolling of a plate to a cylindrical surface. Their contact places had a form of the butt joints with the groove weld supported by a welding pad. Such a design solution is presented in Figure 5.

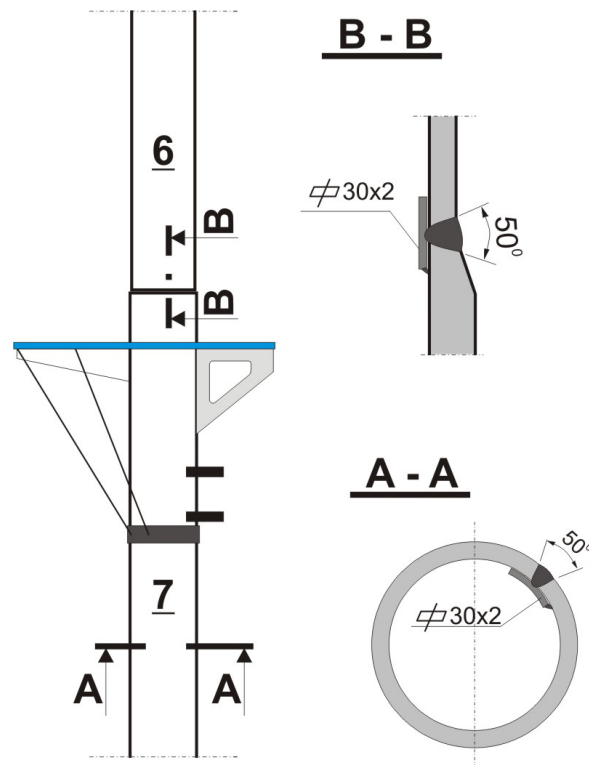

Fig.6. Mast structure and details of the joints

2. Causes of the skin material weakness in some mast cross-sections

As it was already mentioned, all weakening places were situated beneath the welded connections joining the separated parts of the foremast and mainmast (fig.3). In our opinion, the accelerated corrosion of the skin material in heat-affected zones of weld joints was the main cause of the foremast and mainmast destruction. This kind of corrosion resulted from the synergic co-operation of two factors which had both the design and the technological nature.

Individual segments of mast tubes were connected together by the butt joints with the groove weld (Fig. 6). In order to prevent various discontinuities in fusion welds (for example incomplete or lack penetrations), inside all of tubes connections were applied the special welding pads fixed by the fillet weld (Fig. 6).

The design factor is just related with a use of the mentioned sleeves. Such a joint design caused to accumulate of water at the upper part of sleeves (fig. 7a). It appeared as the result of water steam condensation due to air temperature decreasing especially at nights. Such a phenomenon have been observed and confirmed by Pogoria crew. Designers of masts also knew about such a phenomenon because they foresaw the special ventilating openings in the upper parts of masts. Nevertheless, the accumulated water penetrated places between tubes and sleeves what contributed to accelerate corrosion of the mast skin material. (fig. 7b). Picture of phractography of cross section of failure part of mast is presented in Fig.7c.

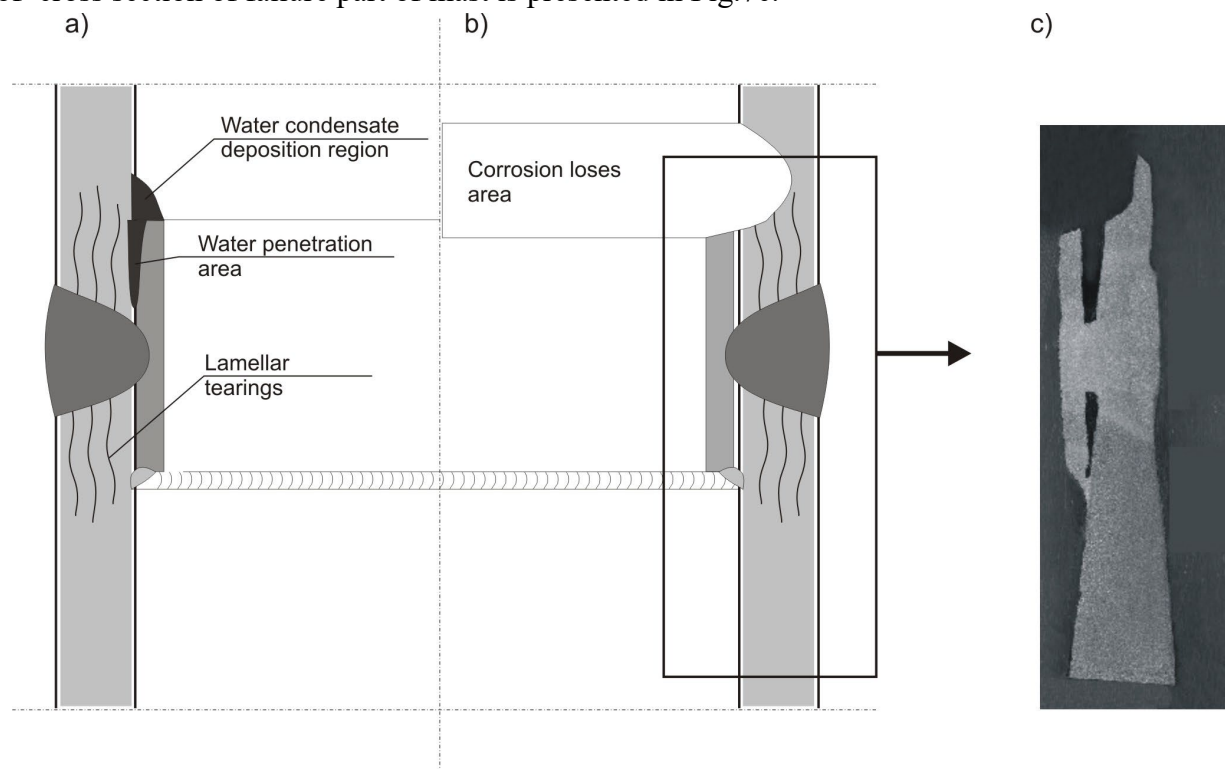

Fig. 7. Way of destruction of the segment connection of mast tubes: a) the places of water penetration and lamellar tearing; b) places of mast skin weakening; c) fractography of corroded joint region

The technological factor is related with development of the parallel cracks in the rolled and welded metal sheets of the mast skin material. Changes of both the material structure and the skin



deformations triggered off by a welding process had the essential influence on the crack formation. One of cracks is lamellar tearing which can occur beneath the weld especially in rolled steel plate which has poor through-thickness ductility. It is generally recognized that there are three conditions which must be satisfied for lamellar tearing to occur [2]:

- transverse strain - the shrinkage strains on welding must act in the short direction of the plate i.e. through the plate thickness,
- weld orientation - the fusion boundary will be roughly parallel to the plane of the inclusions,
- material susceptibility - the plate must have poor ductility in the through-thickness direction.

Thus, the risk of lamellar tearing will be greater if the stresses generated on welding act in the through-thickness direction. Lamellar tearing is more likely to occur in large welds typically when the leg length in fillet and T butt joints is greater than 20 mm. As restraint will contribute to the problem, thinner section plate which is less susceptible to tearing, may still be at risk in high restraint situations. In the case of Pogoria, the transverse strain occurred due to a high level of dynamic loads triggered off by wind acting in various directions and with changeable forces. This, in turn, caused to appear bending moments and shearing force in surrounding places of tube weld connections. The lamellar tearing contributed in the water penetration accelerating corrosion of the mast skin material.

In our opinion, due to both the high transverse strain and the mast skin poor ductility in the through-thickness direction such situations occurred in welded joints of Pogoria masts because the surface of the fracture was fibrous and 'woody' with long parallel sections (Fig. 5). The orientation of the tears in butt welds of Pogoria masts are presented in Figure 6a.

Undoubtedly, the synergic cooperation both **the design and technological factors** caused to acceleration of the skin material corrosion of Pogoria masts (Fig. 6b). Such phenomenon has been proved by analysis carried out directly after the accident. It allowed us to unambiguously affirm that all mast fractures had the clear wedge sharpness at their bottom parts (Fig. 4) and the characteristic stratification at their upper parts (Fig. 5).

Additionally, a way of mizzenmast deformation confirms our assertions because work conditions of this mast were totally different. Exhaust gases discharged from a main engine and aggregates heated this mast and counteracted in accumulating of water at the upper part of its sleeves.

5. Analysis of the Influence of corrosion on stress level

During of analyze of the pictures made just after damage (Fig.1) one can found, that beside of remained on the deck part of the foremast, rest was broken into three parts – as it marked in Fig.2 and Fig.8.b. It was certified, that during the accident, all ropes and hooks worked properly. Taking above mentioned into account, one can assumed expected model of the foremast damage – as it is presented in Fig.8.b. For the calculation, cantilever beam model semi-supported in places of platforms was applied – presented in Fig.8.c.

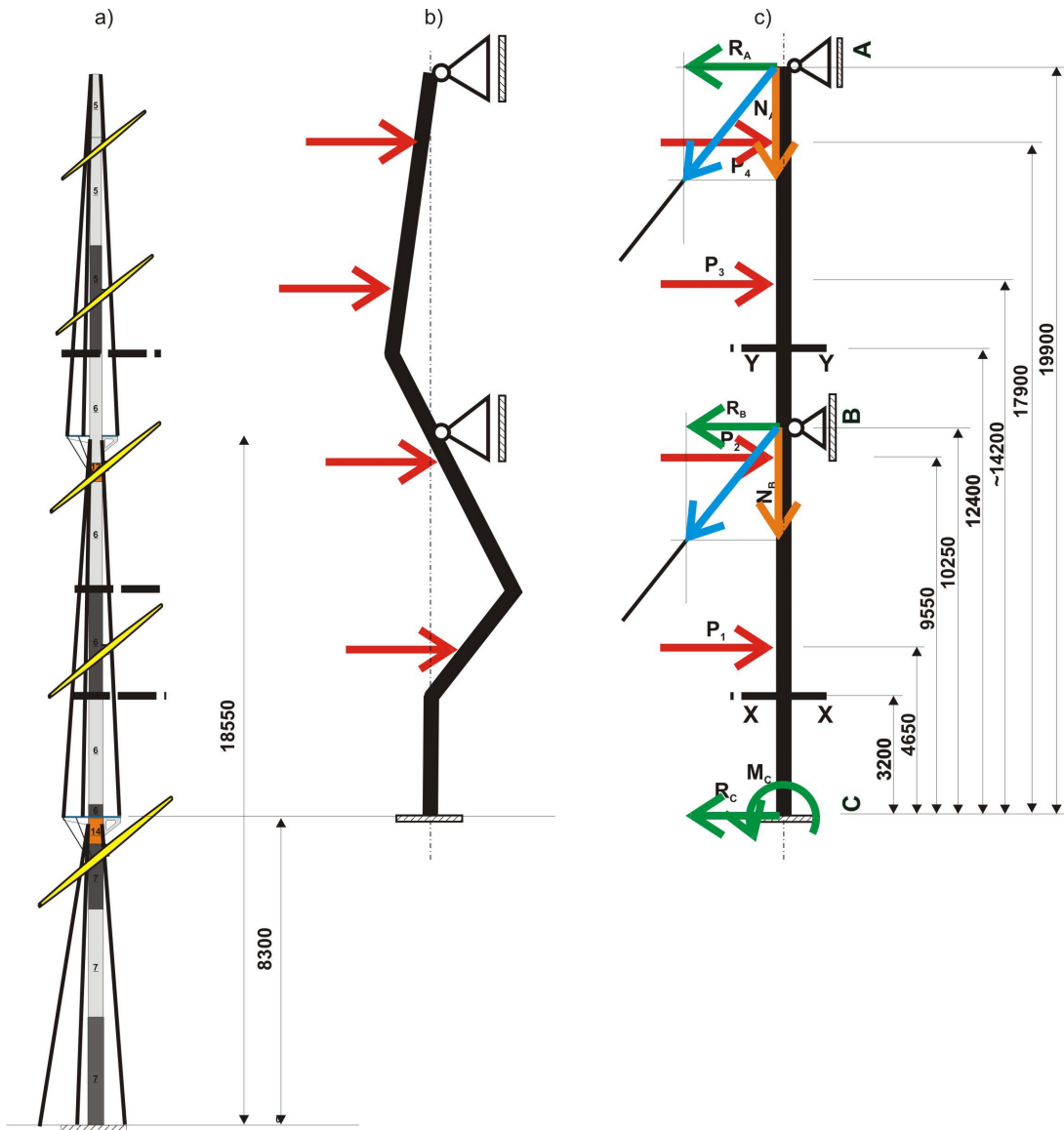

Fig. 8: Failure of the foremast: a) location of failures, b) model of damage, c) substitute model for calculation.

For load calculation, squall wind 7 degrees in the Beaufort scale was assumed with respected dynamic pressure amount $p=259,97$ [Pa] [5]. Point loads – as result of the integrated pressure reaction was attached to the mast in points of hinges of rigs location – respectively. Assumed beam calculating model is statically indeterminable, so integration of shear forces distribution function was necessary. After integration with boundary condition taking into account, bending moment and shear forces distribution was obtained – Fig.9

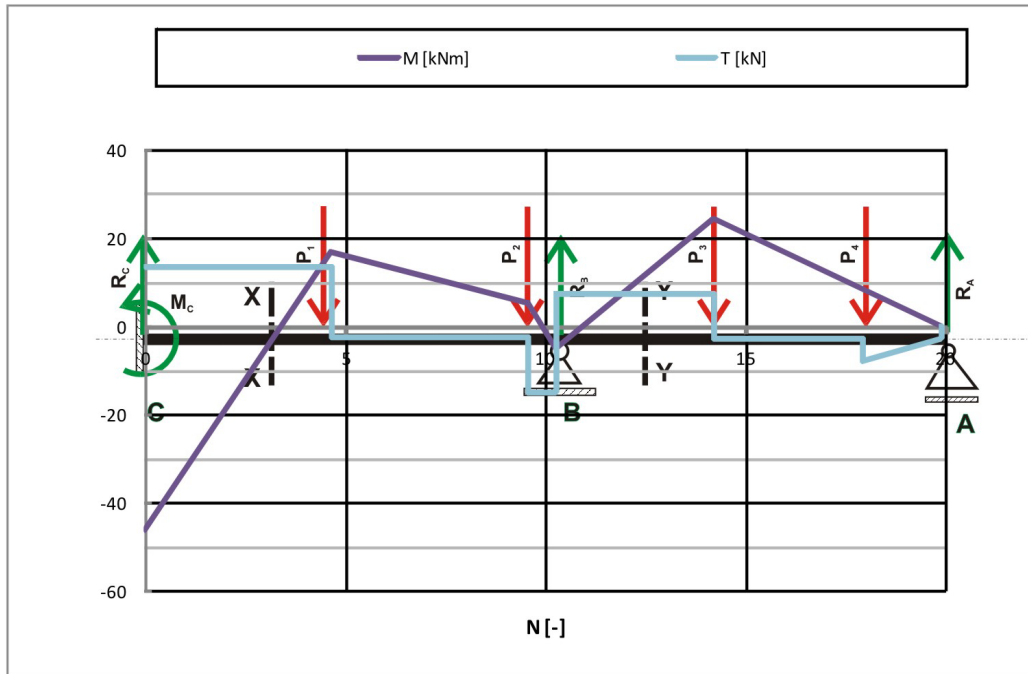

Fig. 9. Calculated distribution of the bending moment (M) and shear force (T)

Based upon results calculated, an analysis of the equivalent stress level for two mast sections (failure during accident) marked in Fig.6a as X-X and Y-Y, was made. As stress state components – beside load from bending moment and shear forces, axial compressing force – coming from solid rigs – marked as N_A and N_B in Fig.8.c. – was taken into account also. For comparison calculations have been performed for two sets of geometrical data: design diameters and shell thickness as well as for real cross section data measured from real, corroded structure after collapse.

Equivalent stresses for analyzed sections amount as follows: .

For nominal design cross section parameters: section X-X: 23 [MPa], section Y-Y 32 [MPa].

For real shell thickness measured for section X-X equal 0,5 [mm]: section X-X 268 [MPa] and 308 [MPa] for section Y-Y. One can see that safety margin for non-corroded structure was about 8. Analysis of calculations shows that such corrosion like presented reduced safety margin to zero.

6. Problems of the detection of such type of corrosion

Analysis of pictures of parts of destroyed masts reveals (Fig. 10) that corroded area cover limited part of mast volume – region close adjacent to circumferential welds. Rest of the surface is steel covered – from inside by original protected coating, - from outside – by zinc layer – Fig. 10.

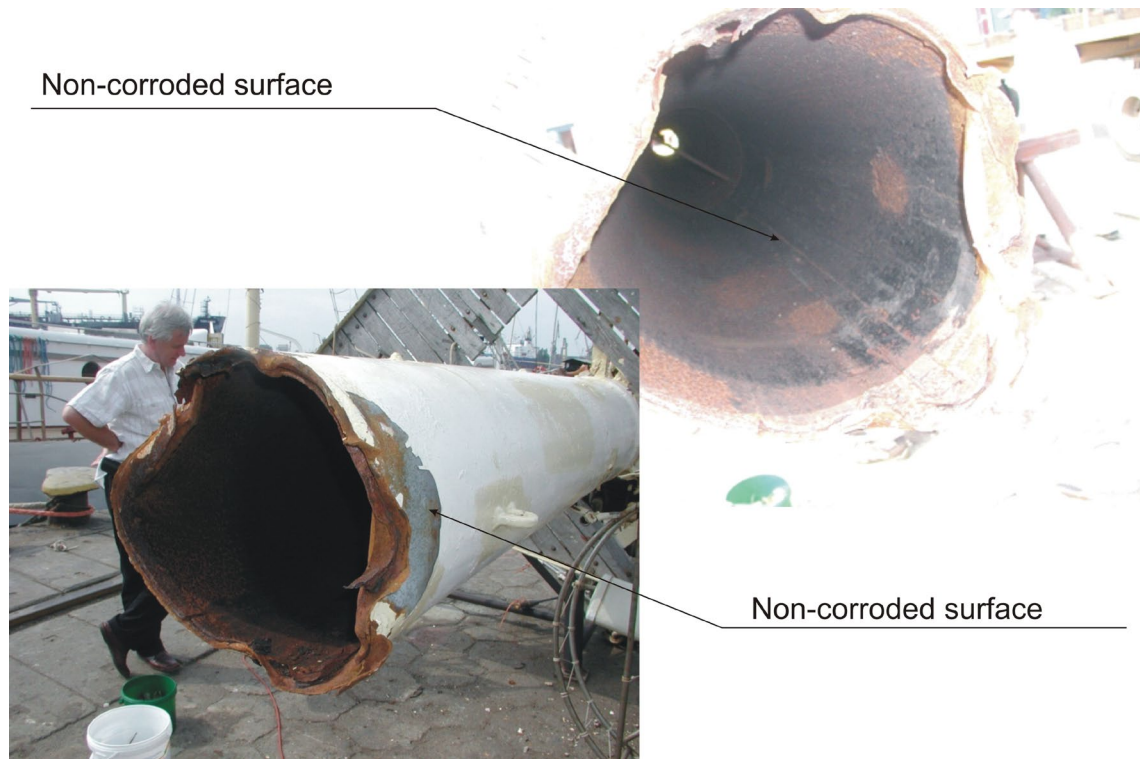

Fig.10. Location of the corroded area in the foremast segments

Analysis of the fractography of corroded region (Fig.7c) reveals, that local depth of corrosion centers is relatively high. Such type of corrosion can be described as deep local pitting corrosion. Moreover – the same picture evidences that corrosion processes developed only internally and not penetrated through whole thickness of tube wall.

This fact means, that even after total removing of external paintings by sand blasting, it was not possible to find out of the existence of such deep corrosion losses area. From the other side application of the most common steel thickness method – ultrasonic measurement – also can bring not quite clear data due to specific of the internal joint geometry. As one can see in Fig. 11 location of the corroded regions is strictly connected with position of the welding pad in relation to but weld centre: for one case this is region located closely to the weld fusion area, for other case – in the some distance of it. If one compare size of the typical measurement unit of ultrasonic thickness meter with size of corrosion losses, one can see that for some cases typical measurement process conducted closely to the root of the weld will not detect of the such type of corrosion losses.

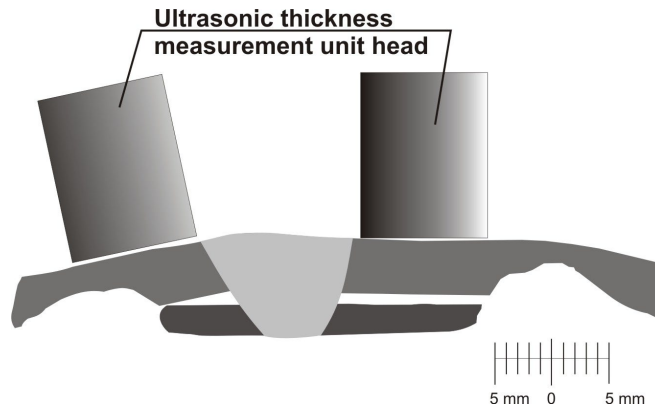

Fig.11. Size of the typical ultrasonic thickness meter measurement unit on the background of contour of corrosion losses.

So during standard periodic surveying procedures, probability of detecting of such type of corrosion effects is relatively low. The last conclusion presents risk factor for such type of structure – only very careful systematic thickness measurement procedure with internal thickness profile analysis can indicate potential loosing of the safety margin.

7. Conclusions.

Both the undertaken analysis of mast damages and the carried out considerations relating to the destruction causes permitted us to formulate the following conclusions:

- the possibility to predict of results of all adopted design solutions not always exists, especially with reference to a prototype unit like Pogoria,
- such a kind of event will occur in not long time maybe as a result of gravity loading,
- it is necessary to check the technical conditions on board of all sailing vessels with similar design of masts,
- it should be developed new technologies providing the high quality of welded joints in such types connections of individual segments of sailing vessel masts.
- it should be introduced new surveying standards related to the steel welded sailing vessel masts.

References.

1. Beluga SkySails. Turning Wind Into Profit. ShipBuilding Industry. Vol. 2. No.2. pp.30-35.
2. Defects - lamellar tearing. TWI – Technology Engineering.
<http://www.twi.co.uk/content/jk47.html>
3. Młynarczyk J.: Bezpieczeństwo statecznościowe jachtów żaglowych w aspekcie uwarunkowań pogodowych. Wyd. Prace badawcze W.O.iO Politechniki Gdańskiej. Nr.07/2003/BW. Gdansk 2003.
4. Młynarczyk J.: Fenomena pogodowe i hydrodynamiczne a bezpieczeństwo jachtów. Materiały konferencji: Bezpieczeństwo w jachtingu, Wyd. JSC. PZŻ i PZMiNW. Gdynia 2002.
5. Publikacja 29/P Polski Rejestr Statków, 1996