

Comparative analysis of exoskeletal actuators

Grzegorz Redlarski, Krzysztof Blecharz, Mariusz Dąbkowski,
Aleksander Pałkowski, Piotr M. Tojza

Faculty of Electrical and Control Engineering, Gdansk University of Technology

Abstract: Since the beginning of the development of exoskeletons in the early 1960s there was a constant need for improving their actuators technology. Requirements for high power and torque for the lower body and very high precision for the hand motion, while maintaining the flexibility of biological muscles, are still not fully satisfied. The problem lies not just in the lack of appropriate actuator technology, but also in the inability to meet their energy needs. This paper contributes to this problem, first by describing the most commonly used technologies and then by presenting simulation results for lower limb exoskeleton motion. In addition the energy requirements of the modeled devices and their control possibilities along with their usage in various parts of the exoskeleton construction are analyzed.

Keywords: exoskeleton, artificial muscle, actuator, energy source, modeling

1. Introduction

Currently, exoskeletons are one of the most advanced branches of mechatronics. The essence of these systems is generally to support the processes of human movement through the use of technologically advanced equipment and technology, particularly in the field of prosthetics. These devices through a set of sensors – typically used in electroencephalography, or electromyography [1–3] and actuators [1, 3] lead to the construction of devices, in which the essence of movement is consistent with the will of the user, without the need for additional peripheral devices – for example, a joystick [23].

The first research on exoskeletons date back to the beginning of 60s in the last century. The aim of the pilot project, undertaken by the Department of Defense of The United States of America, was to create an armor that increases the strength of the user. The main barriers in the development of this concept were the technological limitations of power systems (too heavy and inefficient), sensors, structures, and actuators. However, the study of pneumatic artificial muscle (PAM), which started in the 60's [5] and the subsequent development of this technology (e.g. the solution presented by the Japanese company Bridgestone) gave further development of exoskeletons. The emergence of modern and far more efficient electric motors (e.g. brushless stepping motors) additionally contributed to the development of exoskeletons.

The primary factors associated with the emergence of these disadvantages include high power consumption resulting from the need to obtain a high torque drive during movement of the limb, and consequently – also high ener-

gy requirements for applied actuators and control systems. Presented in [6] studies of the mechanics of the limbs movement show, that during human walk peak torque at the knee is 0.34 ± 0.15 Nm/kgm for women and 0.32 ± 0.15 Nm/kgm in the case of men. This means that, e.g., for a man weighing 80 kg and 180 cm tall, peak torque at the knee during normal walk is 45 Nm.

These arguments show that the energy requirements for exoskeletons should be considered as fully significant, current and not quite properly recognized. For this reason, in this article the essence of the energy requirements of the actuating device adapted for use in structures of exoskeletons responsible for assisting movement of the knee was presented. The article focuses on a comparison of the two main technologies for exoskeleton limb actuators – DC brushless motors and *pneumatic artificial muscles*. The first part describes the actuators based on electric motors, McKibben muscles as well, as shape memory materials and dielectric elastomers. Secondly the models and the results of numerical simulation are given. Finally, given at the end are the key conclusions and predictions resulting from the use of the examined technology in building exoskeletons.

2. Actuator technologies

2.1. Electric drives

DC motors are currently the group of most commonly used actuators in robotics. However, as drives in the structure of exoskeletons, servomotors propulsion systems with permanent magnet are used [11–14]. There are two types of motors: synchronous AC motors and brushless DC motors. Permanent magnet motors in relation to other devices are characterized by a number of beneficial properties and characteristics that are particularly important in robotics. The most important among them include a favorable torque to weight ratio, high overload capacity and the ability to develop high torque when the motor shaft is stationary.

2.2. McKibben artificial muscles

Artificial McKibben muscles are an example of technology simulating real action of the elements of mechanics of living organisms that move using limbs. These devices, being powered by a specific medium (liquid or gas – but also latest conducted research focuses on chemically activated pneumatic muscles [24]) mimic the processes of contraction and relaxation of muscles, causing the formation of the corresponding axial stresses. Their main advantage is high power to weight ratio and power to volume ratio – accordingly 1 W/g and 1 W/cm³ [17]. Those values are five times higher than tho-

se offered by electric motors. Another advantage of artificial muscles is that they can work, as so called “soft actuators” [18], which means a higher level of security for the user in the event of structural damage of the exoskeleton, and the low impedance of the actuator itself.

The main drawbacks of this technology, however, are difficulties to accurately control the muscle work, due to the nonlinearity caused by the compressibility of the working medium and the flexibility of the coating [18]. Moreover, some control techniques [22] require the use of adaptive methods, while the use of compressed air as an artificial muscle activating factor requires an adequate supply of this medium, and this in turn requires a compressor and air handling unit, or air containers. For this reason, the mentioned technological solution may affect the weight, stability and range of the exoskeleton. However, it should be stressed that so far the pneumatic artificial muscles have been successfully applied in exoskeletons BLEEX [15] and FREFLEX [16].

2.3. Shape memory alloy artificial muscles

The search for new designs or technology implementation for exoskeletons contributed to the development of innovative materials, such as shape memory materials (SMA – *shape memory alloys*), or dielectric materials. Particularly interesting solutions in this area are achieved by SMA materials. A pioneering scientific research in this area, e.g. [20] provides promising data for the forces that may be obtained from a single artificial muscle fiber made from SMA, as well as its energy efficiency. Another advantage of SMA materials is the ability to control in a simple way the changes in the shape of the fibers, which can simplify the exoskeleton control system and to significantly affect an increase of the level of safety equipment.

3. Dielectric elastomer artificial muscles

It should be noted that research of the possibility to use materials of varying shape concern not only SMA but also the *dielectric elastomers*. Preliminary results in this field [21] show that the developed with the use of elastomers muscles are indeed efficient, but a small amount of change of length and a non-linear value of the contraction force do not yet allow their use as actuators in the major joints of the limbs. But one has to keep in mind that both the dielectric elastomers, as well as SMA materials, are a relatively young technology, and so further discoveries and implemented technical solutions will reduce the disadvantages of these materials that occur today, particularly in relation to their use as materials for artificial muscles.

4. Modeling and simulation of human leg swing phase

4.1. Leg swing model

In order to simulate the movement of the lower limb of man – by analogy – a model of the pendulum was used. This kind of assumption is justified because, during normal walk, the swing movement of the lower leg is like a pendu-

lum, and in addition, for most of this phase, the dynamics of the relevant portion of the limb is similar to the dynamics of the pendulum [8]. For this reason, the relevant part of exoskeleton can be regarded as typical physical pendulum, on which the driving torque τ is applied which is produced by the control device that includes a counteracting resistant force F_r (fig. 1).

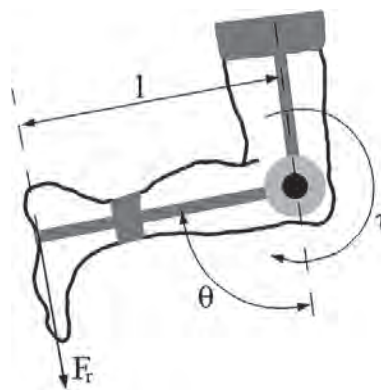

Fig. 1. The forces acting on the exoskeleton in the lower leg section along with its dimensions

Rys. 1. Siły i moment oddziaływujące na egzoskielet kończyny dolnej wraz z wymiarami

Equation (1) contains a mathematical description of the dynamics of the leg, as was applied in model

$$I\ddot{\theta} = \tau - c_0\dot{\theta} - c_1 \operatorname{sgn}(\dot{\theta}) \quad (1)$$

where: I – is the inertia torque, τ – driving torque, c_0 – air resistance coefficient, c_1 – dry friction coefficient, θ – angle of inclination.

4.2. Actuator models

In the studied mechanical model, to produce the drive torque that supports the strength of human muscles, a brushless DC motor with permanent magnets (PMSM) was used. Because of the high dynamic of the permanent magnet servomotor operation, the mechanical components in the presented model were assumed to be rigid. To control the motor, the field-oriented method was used [19]. This control strategy is based on the orientation of the stator current vector relative to the rotor flux, which results in forcing the values of the stator current vector component in the axes d and q and the achievement of an independent control of the electromagnetic torque and stator flux. The presumed motor performance in the first zone regulations is the result of adopting a zero value of the stator’s current component. Thus, forcing the value of the current component is in the d axis it is possible to control the electromagnetic torque of the motor. Furthermore, using in the control system an additional feedback loop from the angle of the motor shaft position, gives the possibility of a quick and accurate adjustment of the angle position of the exoskeleton representing the “shank”. Selection of the PI controller parameters in the control system of the motor shaft angle position is carried out by a computer simulation.

Because of the many models of this type of motor with such control systems, this study used a ready model contained in the libraries of MATLAB/Simulink software.

Fig. 2 shows a schematic diagram of the exoskeleton's lower limb actuated by a servomotor. Together with the motor a mechanical transmission was used.

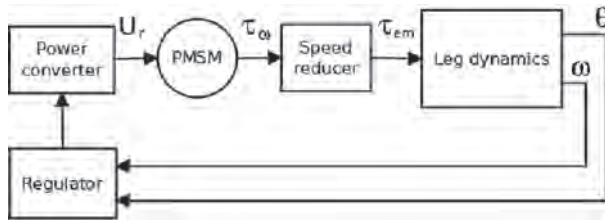

Fig. 2. A model of an motor controlling the movement of the limb
Rys. 2. Model silnika sterującego ruchem kończyny

In the later, there was used a pneumatic artificial muscle model, in an antagonistic configuration, allowing the movement of the limb in both directions (fig. 3). Alternating

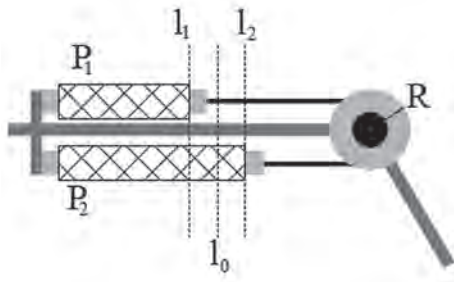

Fig. 3. Antagonistic configuration of a PAM driving the knee joint
Rys. 3. Przeciwna konfiguracja PAM poruszająca stawem kolanowym

contractions and relaxations of both muscles set in motion a combined block of a radius of R , which leads to an angle deflection of the lower limb. This movement is initiated by a change in pressure Δp in each muscles, causing contraction or relaxation – from the initial length of l_0 to the appropriate l_1 and l_2 , where

$$l_0 = \frac{l_1 + l_2}{2} \quad (2)$$

During the development of the mathematical model, the principle of virtual work [9] was used. It assumes the immutability of the muscle's cylindrical shape during deflating and inflating, and lack of energy dissipation associated with the friction forces and deformation of the material it was made of. On this basis, it becomes possible to compare the work done by the air pressure over volume change, dV , of the muscle with the work done by axial tension, F , over length change dL

$$dW_{in} = dW_{out} \Leftrightarrow p_g dV = F dL \quad (3)$$

where: $p_g = p_i - p_{atm}$ is the relative pressure equal to the difference between the absolute internal gas pressure p_i and atmospheric pressure p_{atm} .

Absolute internal gas pressure p_i in the case of antagonistic muscles is equal to $p_0 \pm \Delta p$, where p_0 is the initial internal pressure.

It follows that the function of pressure and muscle contraction determining its axial tension force is

$$F = p_g \frac{dV}{dL} = p_g \frac{\pi \cdot r_0^2}{\sin^2(\alpha_0)} \cdot (3(1 - k\varepsilon)^2 \cdot \cos^2(\alpha_0) - 1) \quad (4)$$

Symbol ε is the aforementioned muscle contraction grade equal to $(l_0 - l)/l_0$, r_0 is the muscle initial radius and α_0 is the initial braid interweave angle. Factor k compensates for the impact of deformation of the muscle at its ends, and for the purposes of this model has a value of 1.25 [10]. Hence the final formula for the force momentum in the ankle block, resulting from the mutually opposing muscle movement, takes the form of [10]

$$\left\{ \begin{aligned} \tau &= (p_1 - p_2) \cdot (K_1 + K_1' \cdot \theta^2) - (p_1 + p_2) \cdot K_2 \cdot \theta \\ K_1 &= \frac{\pi \cdot r_0^2 R}{\sin^2(\alpha_0)} \cdot (3(1 - k\varepsilon_0)^2 \cdot \cos^2(\alpha_0) - 1) \\ K_1' &= \frac{3\pi \cdot r_0^2 k^2 R^3}{tg^2(\alpha_0) \cdot l_0} \\ K_2 &= \frac{6\pi \cdot r_0^2 k R^2}{tg^2(\alpha_0) \cdot l_0} \cdot (1 - k\varepsilon_0) \end{aligned} \right. \quad (5)$$

where ε_0 is the initial muscle contraction grade.

Diagram of the developed system is shown in fig. 4.

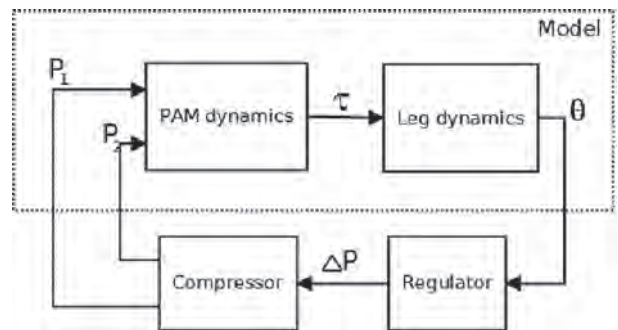

Fig. 4. Diagram of the lower limb motion control using pneumatic artificial muscles
Rys. 4. Schemat sterowania ruchem pneumatycznego sztucznego mięśnia

3.3. Simulation results

All presented results were based on MATLAB/Simulink software. Their aim was to study the swinging motion of the shank part of an exoskeleton, driven by two main types of actuators: a DC brushless motor and pneumatic artificial muscles. The dimensions of the limb segment were taken from the literature [12]: length – 50 cm, weight – 6.5 kg. These values take into account both the mass of the structure and the mass of a limb of a human 180 cm tall and 80 kg in weight.

Artificial muscles were modeled with a length of 30 cm, initial radius of 1 cm and initial braid angle equal to 23°. The initial pressure supplied to both muscles was 3 bar. Moreover, the leg angle control was based on a PID controller adjusted in such way, that the trajectory of the exoskeleton was close to the desired one, which involved bending and straightening the knee in a 4 seconds period (fig. 5).

Based on the obtained results (fig. 7), the total work done by the compressor supplying both muscles (for compression and decompression of gas) is equal to 75.84 J, including the efficiency of the compressor assumed as 0.8. For a two times shorter period of fluctuation, this value amounted to 78.25 J.

On the basis of formula (6), the force, achieved during compression and expansion of gas in the muscle in specific moments of time, was determined (fig 7).

$$P = p \cdot dV \tag{6}$$

A congruent series of simulations were performed for a permanent magnet synchronous motor (for which

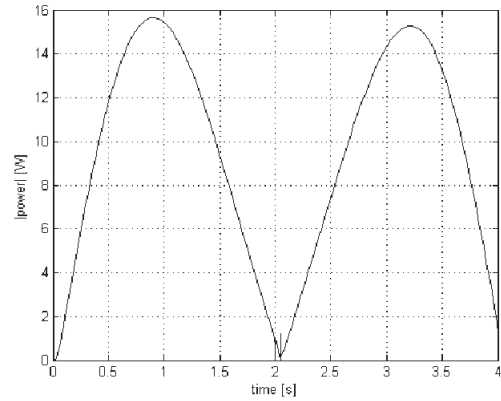

Fig. 7. Actual power during the work of one PAM
Rys. 7. Moc rzeczywista działającego PAM

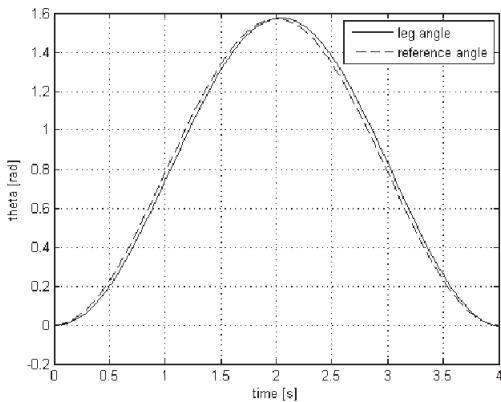

Fig. 5. The tilt angle of a PAM powered leg exoskeleton
Rys. 5. Kąt wychylenia egzoskieletu kończyny dolnej poruszanej przez PAM

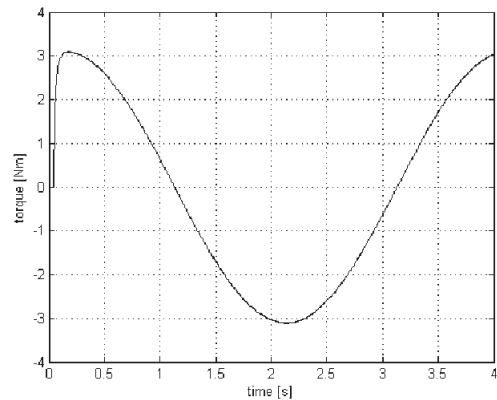

Fig. 8. Torque achieved during the leg fluctuations driven by the DC brushless motor
Rys. 8. Moment uzyskany podczas ruchu kończyny dolnej poruszanej bezszczotkowym silnikiem DC

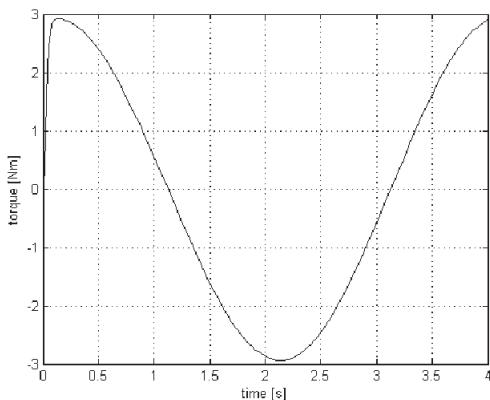

Fig. 6. Torque achieved during the leg fluctuations driven by a PAM
Rys. 6. Moment uzyskany podczas ruchu kończyny dolnej poruszanej przez PAM

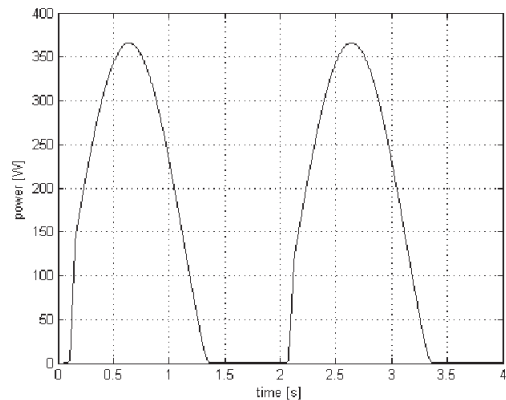

Fig. 9. Actual power during the work of the DC brushless motor
Rys. 9. Moc rzeczywista działającego bezszczotkowego silnika DC

the gear ratio was 130). As a result, a similar to the PAM control quality was achieved. The mean values of torque and power (measured in the voltage inverter DC-link circuit) for an exoskeleton leg motion are shown in fig. 8 and fig. 9. System losses were taken into account during the simulation.

The peak torque resulting from the chart in fig. 8 is 3.05 Nm, while the energy consumed on this process by the motor was 594.7 J, representing a nearly 8 times higher value than the one achieved by the artificial muscles.

5. Conclusion

This paper shows the most popular actuator solutions for exoskeletons being under current development. However, it should be stressed that the shape memory alloy and dielectric elastomer materials, due to small force and displacement capabilities, are suitable mainly for use as actuators for joints which are not subjects of significant amount of force for long periods of time. Such applications may be suitable for systems driving, e.g., the wrist, metacarpal or hinge joints.

Presented examples of the electric motor drive and McKibben muscle are commonly used as actuators in the major arm and leg joints. In particular, achieved through high force momentum, they are suitable for driving the hip, knee and ankle, which are subjected to the highest, long-acting stress.

Taking into account the simplification of the calculations made for the PAM work, it can be said that their energy requirements during the specified motion are much smaller than for the electric motor drive with a converter. However, because of the current technology of mobile energy sources, which are not able to provide adequate power to move all elements of a construction of large size and considerable weight, it is insufficient for a long and stable operation of the exoskeleton structure. According to [1], currently the most popular types of batteries can supply power within the limits of 35–240 W/kg.

In summary, it is therefore considered that the future of exoskeletal actuators depends on the development of biomimetic technologies, such as presented pneumatic muscles or SMA based actuators. Although, it should be also noted that there exists control difficulties and – in the case of McKibben muscles – noise during operation along with the compressor allocating problem. However, the small energy requirements, significant safety of operation and large volume ratio of these technologies make them very interesting subjects to develop.

Bibliography

1. Pons J.L., *Wearable Robots: Biomechatronic Exoskeletons*, John Wiley & Sons, 2008.
2. Pons J.L., *Rehabilitation Exoskeletal Robotics*, "IEEE Engineering in Medicine and Biology Magazine", vol. 29, no. 3, 2010, 57–63.
3. Casolo F., Cinquemani S., Cocetta M., *On Active Lower Limb Exoskeletons Actuators*, Proceeding of the 5th International Symposium on Mechatronics and its Applications, 2008, 1–6.
4. Rosen J., Brand M., Fuchs M.B., Arcan M., *A Myosignal-based Powered Exoskeleton System*, IEEE Transactions on Systems, Man and Cybernetics, Part A: Systems and Humans, vol. 31, no. 3, 2001, 210–222.
5. Schulte R.A., *The Characteristics of the McKibben Artificial Muscle*, "Application of External Power in Prosthetics and Orthotics", vol. 874, 1962, 94–115.
6. Kerrigan D., Riley P., Nieto T.J., Della Croce U., *Knee joint torques: A comparison between women and men during barefoot walking*, "Arch. Phys. Med. Rehabil.", vol. 81, 2000, 1162–1165.
7. Doke J., Donelan J.M., Kuo A.D., *Mechanics and energetics of swinging the human leg*, "The Journal of Experimental Biology", vol. 208, 2005, 439–445.
8. Mochon S., McMahon T.A., *Ballistic walking*, "Journal of Biomechanics", vol. 13, 1980, 49–57.
9. Chou C.-P., Hannaford B., *Static and Dynamic Characteristics of McKibben Pneumatic Artificial Muscles*, Proceedings of ICRA, vol. 1, 1994, 281–286.
10. Tondu B., Lopez P., *Modeling and control of McKibben Artificial Muscle Robot Actuators*, "IEEE Control Systems Magazine", vol. 20, no. 2, 2000, 15–38.
11. Garrec P., Friconneau J.P., Measson Y., Perrot Y., *ABLE, an Innovative Transparent Exoskeleton for the Upper-Limb*, IEEE/RSJ International Conference on Intelligent Robots and Systems, 2008, 1483–1488.
12. Chen F., Yu Y., Ge Y., Sun J., Deng X., *WPAL for Enhancing Human Strength and Endurance during Walking*, International Conference on Information Acquisition, 2007, 487–491.
13. Pratt J.E., Krupp B.T., Morse C.J., Collins S.H., *The RoboKnee: An Exoskeleton for Enhancing Strength and Endurance During Walking*, IEEE International Conference on Robotics and Automation, vol. 3, 2004, 2430–2435.
14. Aguirre-Ollinger G., Colgate J.E., Peshkin M.A., Goswami A., *Design of an Active 1-DOF Lower-Limb Exoskeleton with Inertia Compensation*, "The International Journal of Robotics Research", vol. 30, no. 4, 2011, 486–49.
15. Chu A., Kazerooni H., Zoss A., *On the Biomimetic Design of the Berkeley Lower Extremity Exoskeleton (BLEEX)*, Proceedings of the IEEE International Conference on Robotics and Automation, 2005, 4345–4352.
16. Tsagarakis N., Caldwell D.G., Medrano-Cerda G.A., *A 7 DOF pneumatic muscle actuator (pMA) powered exoskeleton*, 8th IEEE International Workshop on Robot and Human Interaction, 1999, 327–333.
17. Reynolds D.B., Repperger D.W., Phillips C.A., Bandy G., *Modeling the Dynamic Characteristics of Pneumatic Muscle*, "Annals of Biomedical Engineering", vol. 31, 2003, 310–317.
18. Caldwell D.G., Medrano-Cerda G.A., Goodwin M., *Control of pneumatic muscle actuators*, "IEEE Control Systems Magazine", vol. 2, 1995, 40–48.
19. Drury B., *Control Techniques Drives and Controls Handbook*, Institution of Engineering and Technology, 2001.
20. Safak K.K., Adams G.G., *Modeling and simulation of an artificial muscle and its application to biomime-*

- tic robot posture control*, "Robotics and Autonomous Systems", vol. 41, no. 4, 2002, 225–243.
21. Pei Q., *Artificial Muscles based on Synthetic Dielectric Elastomers*, 31st Annual International Conference of the IEEE EMBS, 2009, 6826–6829.
 22. Medrano-Cerda G.A., Bowler C.J., Caldwell D.G., *Adaptive position control of antagonistic pneumatic muscle actuators*, IEEE/RSJ International Conference on Intelligent Robots and Systems, 1995, 378–383.
 23. Tojza P.M., *Support Systems for Human Limb Movement Controlled by Muscle Contraction*, MSc dissertation, 2011.
 24. Leephakpreeda T., *Mathematical Modeling of Pneumatic Artificial Muscle Actuation via Hydrogen Driving Metal Hydride-LaNi₅*, "Journal of Bionic Engineering", vol. 9, no. 1, 2012, 110–118. ■

Analiza porównawcza urządzeń wykonawczych w egzoszkieletach

Streszczenie: Od czasu rozpoczęcia prac badawczych nad egzoszkieleciami na początku lat 60. ubiegłego wieku, istniała ciągła potrzeba udoskonalania technologii związanej z urządzeniami wykonawczymi egzoszkieleciami. Wymóg spełnienia zapotrzebowania na dużą mocą i moment dla kończyn dolnych oraz wysokiej precyzji dla ruchów rąk, przy jednoczesnym zachowaniu giętkości mięśni biologicznych, nie został dotychczas zachowany. Problemem nie jest tylko brak odpowiednich technologii, ale również niemożność spełnienia zapotrzebowania energetycznego. W artykule nawiązano do tego zagadnienia, opisując najczęściej stosowane technologie, a następnie przedstawiając wyniki symulacji dla ruchu egzoszkieleciami kończyny dolnej. Dodatkowo przeanalizowano wymogi energetyczne modelowanego układu, możliwości sterowania, jak również możliwe zastosowanie dla różnych części egzoszkieleciami.

Słowa kluczowe: egzoszkieleciami, sztuczne mięśnie, urządzenia wykonawcze, źródło energii, modelowanie

Grzegorz Redlarski, PhD, DSc, Eng.

Headmaster of the Department of Mechatronics and High Voltage Engineering at the Electrical and Control Engineering Faculty at Gdansk University of Technology. He received his MSc. in 2000 within the specialization of control engineering and advanced in the specialization of electrical engineering. As a result, he received his PhD. in 2003 and DSc. in 2011. From 2011 he is also employed as an Associate Professor at the Faculty of Technical Sciences at the University of Warmia and Mazury in Olsztyn. His main fields of interest are powerelectronics, power engineering and, recently, biomedical engineering.

e-mail: g.redlarski@ely.pg.gda.pl



Krzysztof Blecharz, PhD, Eng.

He received his MSc in 2002 at the Electrical Faculty at Czestochowa University of Technology and his PhD in 2008 at the Electrical and Control Engineering Faculty at Gdansk University of Technology. Currently he is employed as an adjunct professor at the Department of Mechatronics and High Voltage Engineering. His main fields of interest concern: electrical drive control, control of generator systems with two-way powered machines, modern wind power plants and high power electronic converters.

e-mail: k.blecharz@ely.pg.gda.pl



Mariusz Dąbkowski, PhD, Eng.

Adjunct professor in the Department of Mechatronics and High Voltage Engineering at the Electrical and Control Engineering Faculty at Gdansk University of Technology. He received his MSc at this Faculty in 2002 and PhD in 2006. His main fields of interests are robotics, especially mobile robotics.

e-mail: m.dabkowski@ely.pg.gda.pl



Aleksander Palkowski, MSc, Eng.

Employee of the Department of Mechatronics and High Voltage Engineering in the Faculty of Electrical and Control Engineering of Gdańsk University of Technology. He graduated in Control Engineering and Robotics (2012), specializing in Information Technology in Control Systems. His main areas of interest are mobile robotics and application of robotics systems in biomedical engineering.

e-mail: apalkowski@ely.pg.gda.pl



Piotr Mateusz Tojza, MSc, Eng.

Lecturer in the Department of Mechatronics and High Voltage Engineering at the Electrical and Control Engineering Faculty at Gdansk University of Technology. He received his MSc in 2011 in the major of Control Engineering and Robotics, specialization Robotics and Mechatronic Systems. His main fields of interests are: biomedical engineering and application of robotics and mechatronics systems in medical sciences.

e-mail: ptojza@ely.pg.gda.pl

