

Computer-aided analysis of resonance risk in power system with Static Var Compensators

Abstract. *Static Var Compensators operation in a power system may significantly improve voltage profiles in nodes and the reactive power balance, as well as ensure greater system stability in emergency conditions. However these devices may be a cause of a resonance in the system. The aim of this paper is to call attention to the need to include resonance phenomena in a compensator's location evaluation process. The analysis performed in the paper indicates the factors which affect a circuit's resonance conditions, including a change in network configuration and compensator's structure.*

Streszczenie. *Kompensatory SVC mogą znacząco poprawić poziom napięcia w węzłach systemu elektroenergetycznego, bilans mocy biernej, a także stabilność napięciową systemu w warunkach zakłóceń. Jednakże urządzenia te mogą przyczynić się do powstania rezonansu. Celem artykułu jest zwrócenie uwagi na potrzebę analizy zagrożenia rezonansem przy doborze kompensatorów SVC. Wskazano czynniki, które wpływają na powstanie rezonansu – należą do nich m.in. moc i struktura kompensatorów oraz zmiana konfiguracji sieci elektroenergetycznej. (Wspomagana komputerowo analiza zagrożenia rezonansem w systemie elektroenergetycznym z kompensatorami SVC)*

Keywords: reactive power, resonance, Static Var Compensators (SVC).

Słowa kluczowe: moc bierna, rezonans, statyczne kompensatory mocy biernej SVC.

Introduction

One of the key issues in the operation of a power system is to maintain the parameters of supply voltage in the network's nodes at the proper level. Elements which improve voltage stability in a network are reactive power sources, including shunt compensators. The most widespread types of compensators encountered in the power systems are mechanically switched capacitors and reactor banks. Many power systems also include more recent types of these devices, such as SVCs or STATCOMs. The construction of such installations is also being considered for the Polish Power Grid [1].

Compensators' operation in a network may significantly improve voltage profiles in the nodes and the reactive power balance, as well as ensure greater system stability in emergency conditions. From the point of view of the supply network, it is important to distribute new reactive power sources in this network correctly. Properly located, they will give high operational efficiency at the lowest possible cost of the investment. The location choice for a compensator is not simple especially in a meshed system. It requires using diverse methods to analyse the system's condition. The entire process of selecting a compensator's location should include a number of factors related to the features of the compensator and the supply system's operation with and without a compensator [2-6].

Devices which are part of a power grid (i.e. power transformers, transmission lines) have significant inductive reactance values. The application of capacitive power sources may create the risk of a resonant circuit in such conditions [7]. These phenomena may be caused and influenced by following factors: the compensator's structure, its control levels, location, network configuration etc. The study describes the research which evaluates the possibility of resonance occurring in the circuits equipped with SVCs. The analysed compensator locations has been designated at a prior research stage [1].

For all the calculations DlgSILENT PowerFactory® software has been used.

Resonance

Resonance phenomena can be divided into two types – parallel resonance and series resonance.

Parallel resonance (current resonance) reveals itself by high impedance at the resonant frequency. In ideal conditions, the resultant susceptance of a resonant circuit is zero (the impedance phase angle is 0°). During such resonance, resonant frequency currents of significant value may flow within the supply system.

Series resonance (voltage resonance), in turn, is characterised by low impedance at the resonant frequency. The resultant reactance of a the resonant circuit is zero at this frequency (the impedance phase angle is 0° here as well). When this resonance occurs, resonant frequency voltages of significant amplitudes may occur in a supply system.

In highly complex circuits, such as an electrical grid, both types of the resonances can be observed. A given type of resonance may occur at more than one frequency value.

Two types of characteristics are used to determine resonant frequencies: impedance $Z = f(f)$ and phase $\varphi = f(f)$. If the characteristic $Z = f(f)$ for a given frequency value shows a local maximum impedance and at the same time the impedance phase angle is close to 0° , it means that parallel resonance is possible at this frequency. If, however, the characteristic for a given frequency value shows a local minimum impedance and at the same time the impedance phase angle is close to 0° , it means that series resonance is possible at this frequency.

Example characteristics $Z = f(f)$ and $\varphi = f(f)$ with the points of resonance are presented in Fig. 1.

The Researched Model of the System

The research is based on a model which represented the Polish Power Grid. The model was developed at the Gdansk University of Technology, Department of Electrical Power Engineering, to be used to analyse, among others, compensators locations and their impact on the power grid in failure conditions.

In the research three power substations are analysed for possible location of compensator SVC (Fig. 2). The first – G4 – is 400 kV power substation, the second – P4 – is also 400 kV power substation, and the third – T2 – is 220 kV power substation.

The discussed model takes into account in its structure, among other, the following elements:

- 3000 nodes of the power system,

- 307 generators,
- 300 transformers,
- 3484 transmission lines.

Parameters of each element have been precisely defined. Figure 3 presents example data of a transformer introduced to DlgSILENT PowerFactory® software.

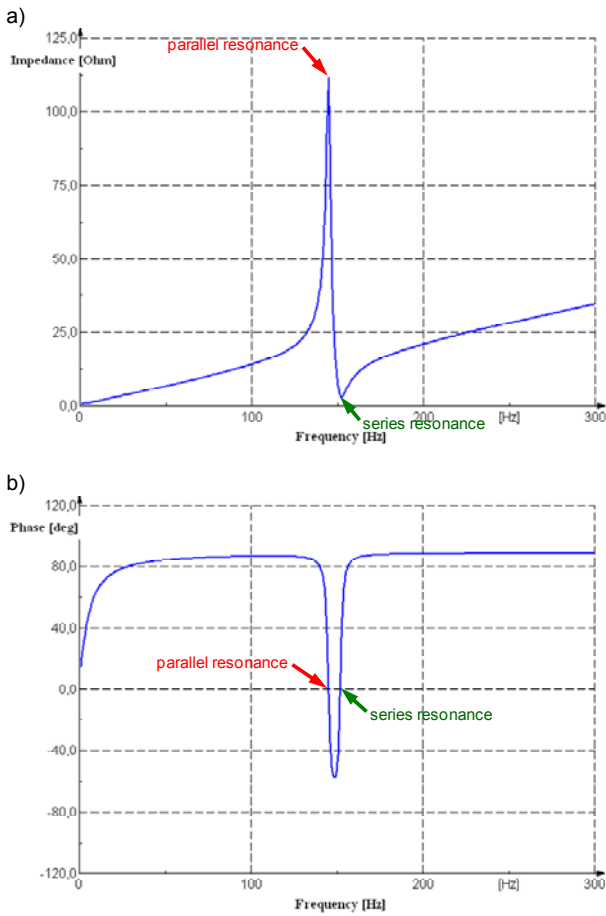

Fig.1. Example characteristics: a) impedance $Z = f(f)$, b) phase $\varphi = f(f)$

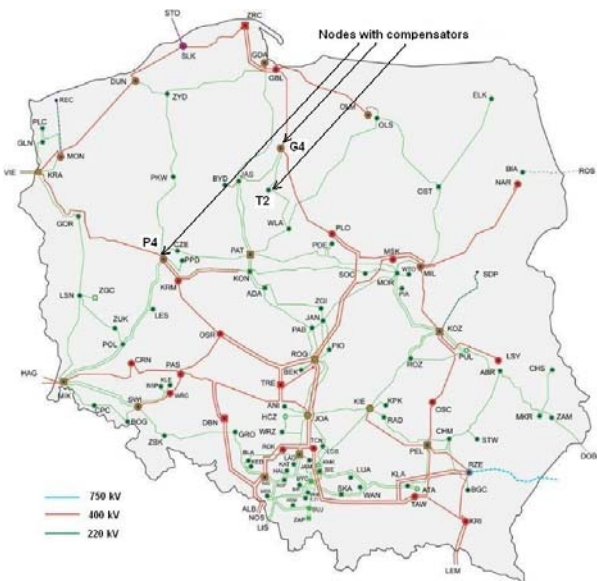

Fig.2. Polish Power Grid structure with the analysed compensators locations

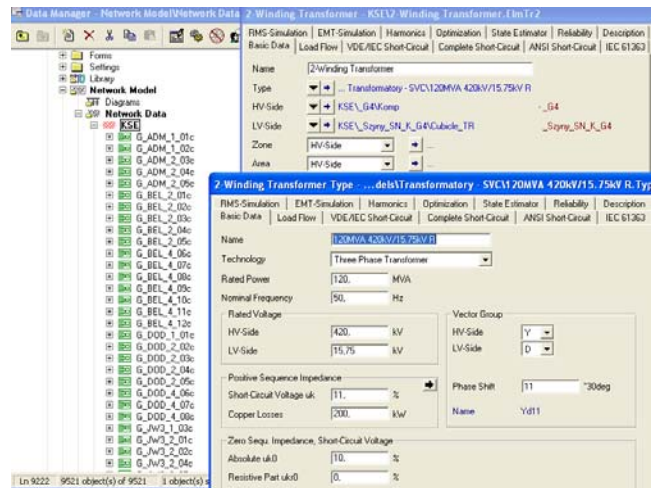

Fig.3. Front panel of DlgSILENT PowerFactory® with technical data of a transformer

The SVC model general structure used in the research is shown in Fig. 4. The location in which the compensator is connected to the power grid is assumed as a point of reference for the further analysis. The assumed SVC elements included in its structure are presented in Table 1.

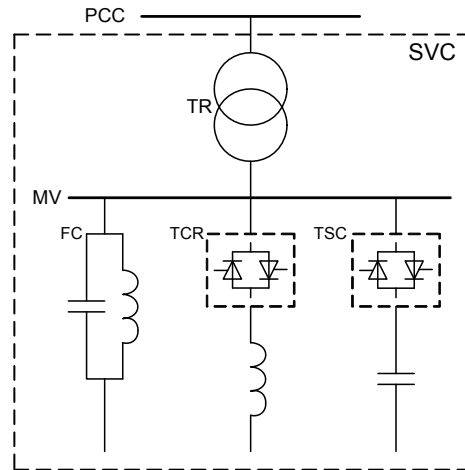

Fig.4. The SVC model general structure used in the research: TCR – Thyristor Controlled Reactor, TSC – Thyristor Switched Capacitor, FC – Fixed Capacitors and/or filters, MV – medium voltage bus, PCC – point of common coupling, TR – transformer

Table 1. Compensator structures included in the research and their codes

Compensator code	Node	TCR [Mvar]	TSC [Mvar]	FC [Mvar]
G4-1	G4	1 x -110	1 x 80	20
G4-2	G4	1 x -90	2 x 50	-
P4-1	P4	1 x -50	2 x 40	20
P4-2	P4	1 x -30	4 x 25	-
T2-1	T2	1 x -30	4 x 25	10
T2-2	T2	1 x -20	5 x 20	-

The Research Results

The research took into account various factors which may have an impact on resonance conditions. These mainly included:

- the number of TSC units and the operation of the inductance device (TCR),
- the influence of network configuration and the influence of another compensator (installed in another node of the power system).

The parameter under observation is the natural frequency designated for each of the system's node equipped with a compensator. This frequency is estimated from impedance characteristics, with accuracy of up to 0.5 Hz.

A. Impedance characteristics of the nodes under analysis

The impedance characteristics had been determined for the nodes in which the compensators were to be installed. These characteristics are presented in Fig. 5. Analysis of the characteristics presented in Fig. 5 reveals that:

- in the G4 node series resonance may occur at the frequency of ca. 373 Hz and 444 Hz, while parallel resonance – at 348 Hz and 404.5 Hz,
- in the P4 node series resonance may occur at the frequency of 370.5 Hz and 418 Hz, while parallel resonance – at 347 Hz and 398.5 Hz,
- no resonant frequencies have been found for the last node (T2).

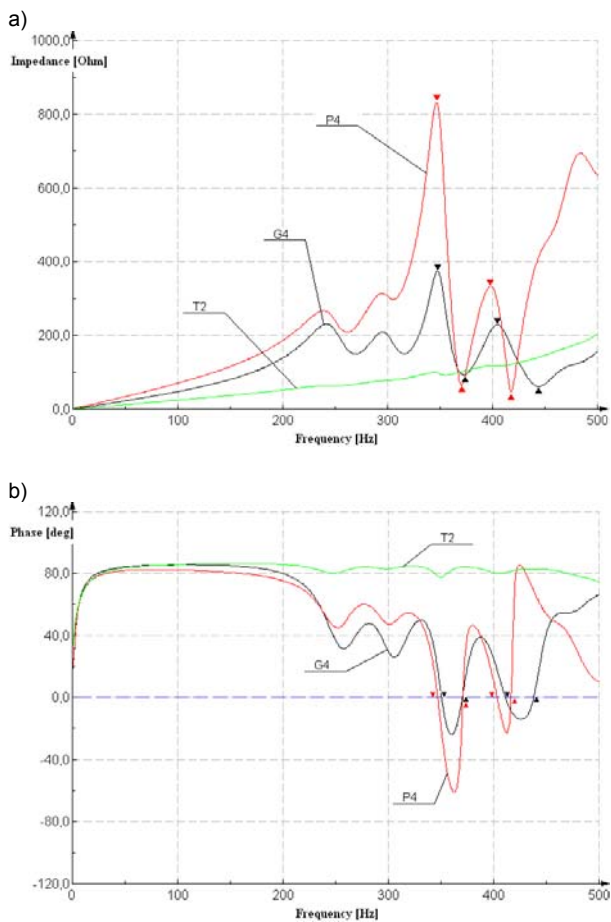

Fig.5. Characteristics of: a) impedance $Z = f(f)$, b) phase $\varphi = f(f)$ for the nodes G4, P4 and T2 without compensator: ▲ – series resonance possible, ▼ – parallel resonance possible

B. Influence of the TCR on the resonant frequency

An addition of a capacitive element to the supply system caused the occurrence of resonance-conductive conditions. This can be observed in the characteristics presented in Fig. 6 to Fig. 8.

The presented characteristics show that there are conditions, conducive to both parallel and series resonance, which occur once at least one unit of a capacitor bank is switched on (or when filters are operating). As more capacitor banks are switched on, the resonant frequencies decrease. The influence of TCR can be seen as a “shift” in the resonant frequencies.

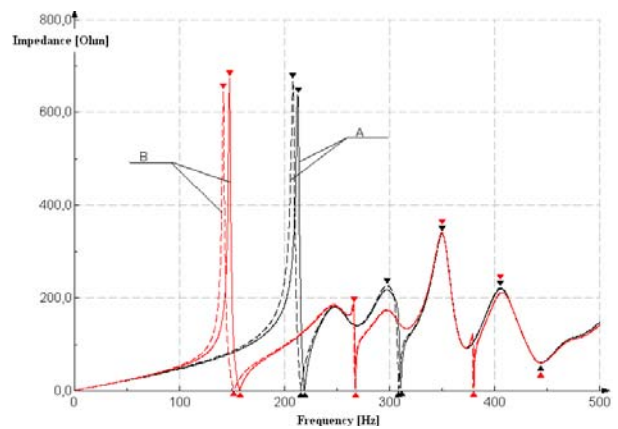

Fig.6. Impedance characteristics for G4 node equipped with G4-1 compensator: A – TSC units switched off, B – 1 TSC unit switched on, solid line – TCR compensates TSC, dashed line – TCR switched off, ▲ – series resonance possible, ▼ – parallel resonance possible

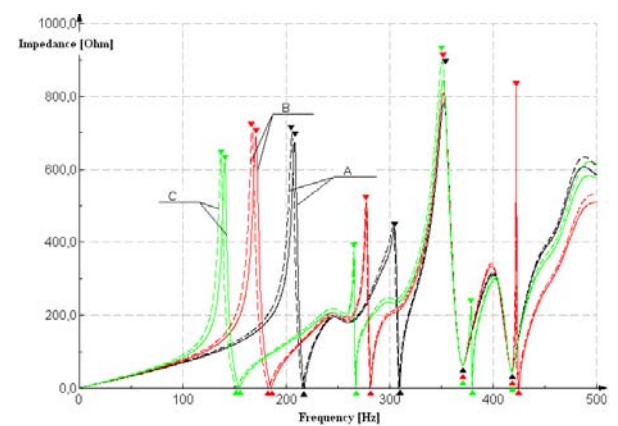

Fig.7. Impedance characteristics for P4 node equipped with P4-1 compensator: A – TSC units switched off, B – 1 TSC unit switched on, C – 2 TSC units switched on, solid line – TCR compensates TSC, dashed line – TCR switched off, ▲ – series resonance possible, ▼ – parallel resonance possible

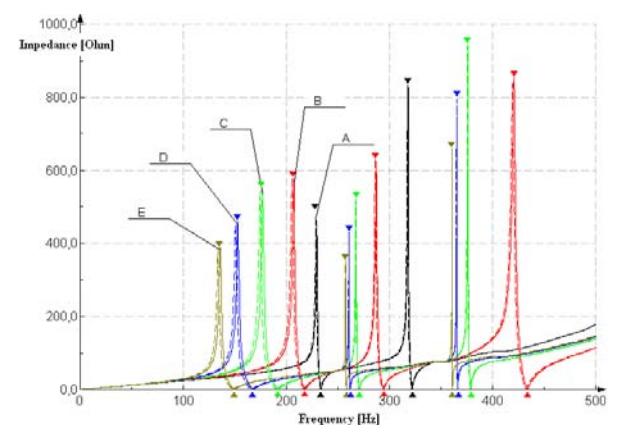

Fig.8. Impedance characteristics for T2 node equipped with T2-1 compensator: A – TSC units switched off, B – 1 TSC unit switched on, C – 2 TSC units switched on, D – 3 TSC units switched on, E – 4 TSC units switched on, solid line – TCR compensates TSC, dashed line – TCR switched off, ▲ – series resonance possible, ▼ – parallel resonance possible

The higher value of the calculated frequency always pertained to a system where the TCR compensated the capacitance of TSC units, while the lower – where the TCR is switched off. Modification of TCR control level makes that

resonant frequencies varies about a few Hz. Maximum variation is about 6 Hz. Values of the resonant frequencies for various TCR control level (TCR off or TCR max power) and various number of TCS units are presented in Table 2.

Table 2. Impact of TCR control level and number of TSC units on resonant frequencies

Compensator code	Series resonance [Hz]		Parallel resonance [Hz]	
	TCR off	TCR max*	TCR off	TCR max*
G4-1 (TSC off)	215.5	219	208	212.5
	309	310.5	297	297
	444	444.5	349.5	349.5
G4-1 (TSC on)	152	157.5	141.5	147.5
	267	267.5	265.5	265.5
	372.5	372.5	349.5	350
P4-1 (TSC off)	215.5	217.5	205.5	208
	309	309.5	303	304.5
	370.5	371	352	352
P4-1 (one section TSC on)	417.5	418		
	182.5	185.5	167	170.5
	281	282	277	277.5
P4-1 (two sections TSC on)	370.5	371	351.5	352
	417.5	417.5	421.5	422.5
	423.5	425		
P4-1 (three sections TSC on)	152.5	155	137	140.5
	267	267	265	265.5
	370	371	350.5	351.5
T2-1 (TSC off)	380	380	378.5	379
	233	233.5	228.5	229.5
	321.5	322	317.5	318
T2-1 (one section TSC on)	217.5	218.5	205.5	207.5
	293.5	294.5	286.5	287
	432.5	433.5	419.5	420.5
T2-1 (two sections TSC on)	191	192.5	174.5	177
	270.5	271	267.5	267.5
	378.5	379	375.5	376
T2-1 (three sections TSC on)	165.5	167.5	150.5	153
	261.5	262	260.5	260.5
	366	366	365	365
T2-1 (four sections TSC on)	148	150	134	136
	258	258	257.5	257.5
	361	361	360.5	360.5

* - TCR delivers max power or compensates one TSC unit (if TSC is switched on)

C. Influence of the number of TSC units on the resonant frequency

In case of compensation with SVC devices, the impedance characteristics are also influenced by the number of TSC units. In order to compare the influence of the various number of the capacitive units on the resonance phenomena risk, several configurations of these units are considered. Figure 9 presents impedance characteristics of the G4 node equipped with a G4-2 compensator which has a greater number of TSC units than G4-1 (Fig. 6), whereas Table 3 presents the list of frequencies at which resonance-conductive conditions occur.

An application of a greater number of TSC units causes increasing of the number of frequency intervals at which resonance-conductive conditions occur. Moreover, the switching on of more TSC units causes resonant frequencies to change discretely towards lower values. This phenomenon is not advantageous from the grid's point of view, but a similar effect is observed when more units of standard capacitor banks are switched on subsequently.

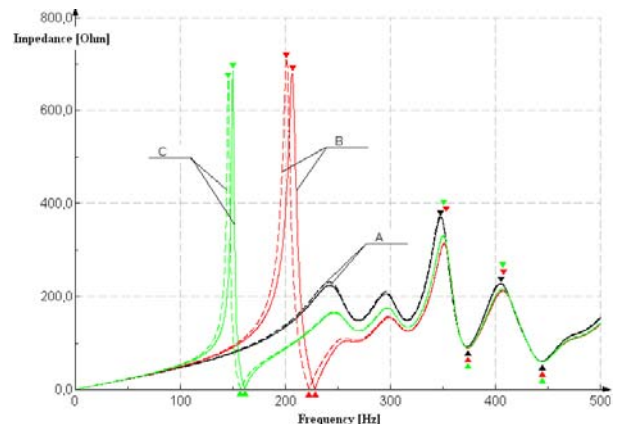

Fig.9. Impedance characteristics for G4 node equipped with G4-2 compensator: A – TSC units switched off, B – 1 TSC unit switched on, C – 2 TSC units switched on, solid line – TCR compensates TSC, dashed line – TCR switched off, ▲ – series resonance possible, ▼ – parallel resonance possible

Table 3. List of frequencies at which resonance-conductive conditions occur – number of TSC banks switched on

Compensator code	No. of TSC units on	Series resonance [Hz]	Parallel resonance [Hz]
G4-2	0	372.5 – 373	347.5 – 348
		444 – 444.5	404.5
	1	222.5 – 228	201 – 206.5
		373.5	351
	2	444 – 444.5	407 – 407.5
		157.5 – 161.5	145.5 – 150
P4-2	0	370.5	346.5 – 347
		418	398.5
	1	315 – 318.5	276.5 – 279
		371	360.5 – 361
	2	418	
		223.5 – 225	195 – 198
	3	370.5 – 371	354 – 354.5
		181.5 – 184	161.5 – 164.5
	4	370.5 – 371	353 – 353.5
		418	
T2-2	0	157.5 – 159.5	140.5 – 142.5
		370.5	352 – 352.5
	1	417.5 – 418	
		-	-
	2	352 – 355	316 – 319.5
		248.5 – 251	223 – 225.5
3	203.5 – 205.5	183 – 185	
	176.5 – 177.5	158.5 – 160.5	
4	151.5 – 159	142 – 143.5	

D. Influence of changes in network configuration on the resonant frequency

During the operation of a power grid, a change of network configuration (topology change) is a typical practice, caused by various switching processes. The switching off of any branch which connects the compensator-equipped node with the rest of the power system changes the resultant impedance of that node.

Figure 10 presents an example comparison between three impedance characteristics for the G4 node obtained when the supply system is under normal operation conditions and when one of the outgoing transmission lines from the substation in which the compensator is connected (named as L1 and L2) is switched off.

Table 4 presents resonant frequencies calculated for the nodes when some transmission lines are switched off (G4 – two transmission lines, the other nodes – one transmission line for each node).

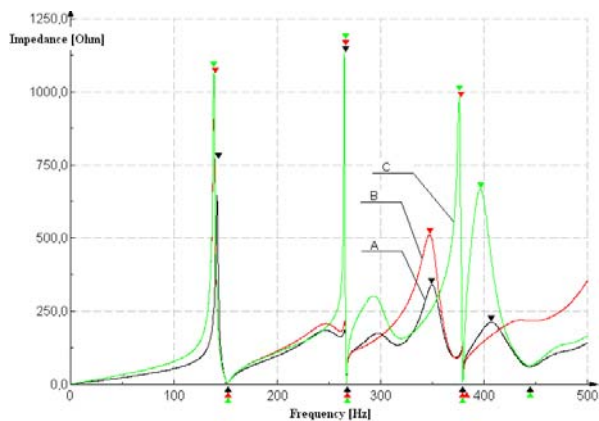

Fig.10. Impedance characteristics of G4 node equipped with G4-1 compensator (TSC switched on): A – network configuration normal, B – transmission line L1 switched off, C – transmission line L2 switched off, ▲ – series resonance possible, ▼ – parallel resonance possible

Table 4. List of frequencies at which resonance-conductive conditions occur – change in network configuration

Compensator code	No. of TSC units on	Series resonance [Hz]	Parallel resonance [Hz]
G4-1 (L1 off)	0	215.5 – 219 309 – 310.5 374.5 395 – 397	206.5 – 211.5 305 – 307 347.5
	1	152.5 – 157.5 267 – 267.5 373 – 373.5 379.5 – 380.5	138.5 – 145 265.5 – 266 347.5 379 – 379.5
G4-1 (L2 off)	0	216 – 219 267 – 267.5 379.5 – 380.5 443.5 – 444	207 – 212.5 291 – 292.5 391 – 392.5
	1	152.5 – 157.5 267 – 267.5 379.5 – 380.5 443.5 – 444	138.5 – 145 265 – 265.5 376 – 376.5 396.5 – 397
P4-1	0	215.5 – 217.5 309 – 309.5	209.5 – 211 305.5 – 306.5
	1	183 – 185.5 281 – 282 423.5 – 425	168.5 – 172 278 – 278.5 417 – 418.5
	2	152 – 154 267 379.5 – 380	138 – 141 265.5 – 266 378 – 378.5
T2-1	0	232.5 – 234.5 321.5 – 322	227 – 228 315.5 – 316.5
	1	217.5 294 – 294.5 432.5	201 – 202.5 284 – 284.5 414.5 – 415.5
	2	191 – 191.5 270 – 271 378.5 – 379	168 – 171 266 – 266.5 374 – 375
	3	165.5 – 169.2 262 366	144.5 – 147.5 260 364.5
	4	148.5 – 151 258 361	127.5 – 130 257 360.5

The resonant frequency changes observed in this case are an individual matter for each node. In some cases, if a transmission line is switched off, the frequency changes slightly, in others a significant frequency shift is observable.

E. Influence of a compensator in a neighbouring node on the resonant frequency

The research shows that if other compensators already exist in the vicinity of the new compensator, it is advisable

to check their mutual influence. A new compensator in a neighbouring node may change resonant frequency in another node with previously installed compensator. Example characteristics obtained for such a case are presented in Fig. 11.

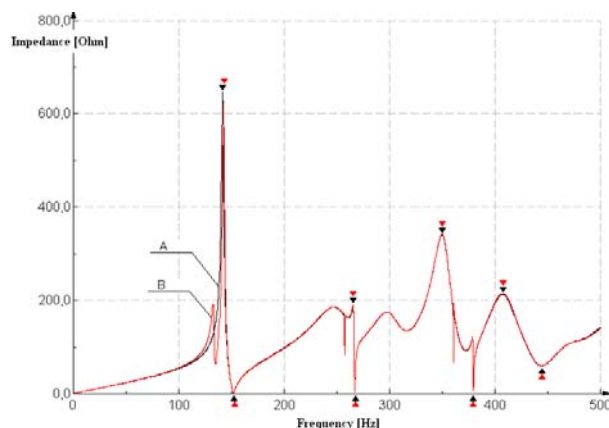

Fig.11. Impedance characteristics in G4 node with operating G4-1 compensator (TSC on) due to the influence of another compensator: A – only the analysed node's compensator is switched on, B – T2-1 compensator in T2 node is switched on (two TSC sections), ▲ – series resonance possible, ▼ – parallel resonance possible

In this case operation of another compensator shifts the first parallel resonance frequency from 141.5 Hz to 142.5 Hz. Other frequencies do not change.

The evaluation of frequency values obtained in this case shows that in the analysed case the maximum change in the resonant frequencies in both the G4 and T2 nodes do not exceed 2 Hz, nor are any additional resonant frequencies found out.

Conclusion

The process of evaluating the risk of the resonant phenomena in SVC-equipped power system should take into account, among the other, the following things:

- the number of TSC units – the higher it is, the bigger the set of frequencies at which resonance can be induced becomes,
- TCR unit's operation – although the reactor's operation contributes to a slight "shift" in the resonant frequency coupled with a change in the control level, it results in a band of resonant frequencies rather than in one specific frequency for a given resonance,
- the presence of other compensators in the network – if they are located in neighbouring nodes, they may change the resonant frequencies in the node under consideration.

The performed analyses make possible to determine the ranges in which the resonant frequencies designated for compensator nodes can change, depending on the power system topology and the compensator operation conditions. If these frequencies overlap with the natural frequency of other sources present in the power system (such as harmonics-introducing devices), there is a risk of the resonance. In the case of a SVC, the risk is high because this device contains a TCR in its structure, which itself is a source of higher harmonics (mainly the 5th and the 7th).

If the natural frequency are found to be compliant with the frequency corresponding to harmonic, appropriate measures to counteract the resonance should be taken. Basic measure is to detune a compensator branch which is a source of resonance. Changes in configuration (topology) of the power network can also be applied.

Authors:

dr inż. Robert Kowalak, E-mail: robert.kowalak@pg.gda.pl;

dr inż. Robert Małkowski, E-mail: robert.malkowski@pg.gda.pl;

dr hab. inż. Stanisław Czapp, E-mail: stanislaw.czapp@pg.gda.pl;

dr inż. Jacek Klucznik, E-mail: jacek.klucznik@pg.gda.pl;

prof. dr hab. inż. Zbigniew Lubosny, E-mail: zbigniew.lubosny@pg.gda.pl;

dr inż. Krzysztof Dobrzyński, E-mail: krzysztof.dobrzynski@pg.gda.pl.

Gdansk University of Technology, Faculty of Electrical and Control Engineering, ul. Gabriela Narutowicza 11/12, 80-233 Gdańsk, Poland.

REFERENCES

- [1] Kowalak R., Małkowski R., Zajczyk R., Zbroński A., Statyczne kompensatory bocznikowe i ich lokalizacja w sieci przesyłowej, *Energetyka*, nr XXIII, maj (2012)
- [2] Kowalak R., Małkowski R., Czapp S., Klucznik J., Lubosny Z., Dobrzyński K., Influence of Shunt Compensation with SVC Devices on Resonance Risk in Power Systems, *XII International School on Nonsinusoidal Currents and Compensation, ISNCC 2015*, Łagów, Poland, (2015)
- [3] Kowalak R., Zajczyk R., Zbroński A., Lokalizacja źródeł mocy biernej w systemie elektroenergetycznym z wykorzystaniem metody zbiorów rozmytych, *Wiadomości Elektrotechniczne*, (2013), nr1
- [4] Lin W-M., Lu K-H., Huang C-H., Ou T-C., Li Y-H., Optimal Location and Capacity of STATCOM for Voltage stability Enhancement using ACO plus GA, *IEEE/ASME International Conference on Advanced Intelligent Mechatronics, Suntec Convention and Exhibition Center*, Singapore, July 14-17, (2009)
- [5] Masoum M. A. S., Jafarian A., Ladjevardi M., Fusch E. F., Grady W. M., Fuzzy Approach for Optimal Placement and Sizing of Capacitor Banks in the Presence of Harmonics, *IEEE Transactions on Power Delivery*, vol. 19, April (2004), n.2
- [6] Mekhamer S. F., El-Hawary M. E., Mansour M. M., Moustafa M. A., Soliman S. A., State of the Art in Optimal Capacitor Allocation for Reactive Power Compensation in Distribution Feeders, *Large Engineering Systems Conference on Power Engineering*, IEEE (2002)
- [7] Pisica I., Bulac C., Toma L., Eremia M., Optimal SVC Placement in Electric Power Systems Using a Genetic Algorithms Based Method, *IEEE Bucharest Power Tech Conference*, June 28th – July 2nd, Bucharest, Romania, (2009)
- [8] Fan Z., Johan E., Harmonic Impedance Analysis in the Presence of Static Var Compensator (SVC), *Power Systems Conference and Exposition, PSCE '06*, (2006)