

CURRENT MEASUREMENTS AND ANALYSIS FOR INDUCTION MOTOR DIAGNOSTICS

Leon Swędrowski

Gdansk University of Technology, Faculty of Electrical and Control Engineering, G. Narutowicza 11/12, 80-233 Gdansk, Poland
(✉ l.swedrowski@ely.pg.gda.pl, +48 59 347 1258)

Abstract

Additional motor vibrations are the result of a faulty bearing. They are reflected in the harmonic content of stator currents. The object of the investigation presented in the paper are measurements related to diagnostics of induction motors, especially damages caused to bearings. Due to the fact that the amplitude of the network voltage basic harmonic in the current spectrum is high in comparison with components responsible for damages of bearings, preliminary elimination of this component from the analog current signal has been proposed.

The problem with interpretation of diagnostic measurements in present systems is the difference between measurement results of characteristic frequencies and theoretical calculations.

In the proposed measurement system this problem was solved in such a way that the value of the angular speed and of the supply frequency is calculated on the basis of appropriate components in the very same current spectrum that is further used in the search for diagnostic components.

The paper presents also the measuring system and provides results of the investigations carried out on a motor encumbered with a specially prepared defect.

Keywords: induction motors, current measurement, diagnostics, roller bearing, spectral analysis.

© 2010 Polish Academy of Sciences. All rights reserved

1. Introduction

The occurrence of a certain type of motor failures can result in distortion of the supply current. This method enables us to reduce diagnostics to searching in the spectrum for components of frequencies determined in advance. In the case of damage to the motor's winding, the supply current spectrum carries data related to frequency components informing about the existence of the failure. Unlike faults in winding, in the case of mechanical defects, *e.g.* a defect in a bearing, the problem is different. The spectrum of the current supplying the induction machine also reveals components which signal such damage. Damaged elements of a bearing cause radial oscillations of the rotor. This is the source of disturbance in the geometry of the air gap of the machine and, in effect, of modulation of the current [1, 2, 3, 4, 5].

The amplitudes of modulated components are very small in comparison with the dominant network component, in particular, at the outset of the failure growth. This creates some problems connected with the measurement of the signal components. A measurement system and the new diagnostic method have been proposed in this paper.

At the beginning it is necessary to determine the theoretical relationships that describe current variations related to specific types of failures.

In the paper [1] there are suggested frequencies connected with bearing faults, according to formulas:

$$f_s = |f_n \pm 1 \times f_v|, \quad (1)$$

$$f_s = |f_n \pm 2 \times f_v|, \quad (2)$$

where:

- f_s – component of current spectrum;
- f_n – the frequency of the supply net;
- f_v – the frequency of vibration connected with a defined fault of the bearing, known from mechanical theory.

A special mathematical model of the object was created for induction motor diagnostics by current measurements [6]. Simulations for defined types of bearing faults were carried out on the model. On the basis of these simulations the author has made a hypothesis that all the frequency components occurring in the spectrum of a motor with centric rotor can be modulated by $\pm f_v$ and $\pm 2f_v$, where f_v is the air gap oscillation frequency. This fact makes allowance for a much larger group of spectral components involved in the investigations than applied at present. Owing to this fact it is possible to avoid erroneous diagnoses when single components disappear in the spectrum. The hypothesis was further proved as the investigations proceeded with simulated failures in an object.

The following conclusions can be drawn from tests performed on a model:

- All frequency components present in the spectrum of a motor with a centric rotor can be modulated with a frequency of f_v and $2f_v$ (and its multiples), where f_v is the frequency of oscillations of the air gap.
- The appearance of a certain type of failures in a motor is the source of oscillations of the air gap, and in this way of distortion of the shape of its stator current. By subjecting the current to spectral analysis one obtains a series of components which are connected with definite types of damage. An analysis of the amplitudes allows recognition of the type of faults.
- The amplitudes of information-carrying spectrum components appear in the region from -60 to -90 decibels with respect to the fundamental frequency of 50 Hz, when the frequency range is 20–3000 Hz. Values are defined as the relation between measured components and the main net component.
- The simultaneous occurrence of static and dynamic eccentricity (which is real in a motor with damaged bearing) results in a high congestion of spectral lines. The components which carry diagnostic information will be in such a situation difficult to detect. Typical faults detected by the method of motor current analysis are damages to the stator and rotor windings as well as misalignment of shafts. The most common cause of failures of squirrel-cage induction motors are, however, faults of bearings.

The author of this paper has made an attempt to create a diagnostic system which would provide credible measurement results, and on their basis, reliable diagnoses of bearings.

2. The diagnostic method

There are a few articles which show that spectrum components, calculated for bearing faults, are not visible in the experimental spectrum. Instead, another components appear. Statistical methods are used for solution of this problem.

In the author's opinion, the calculated frequencies connected with bearing faults can be found in right place in the spectrum, under two conditions:

1. Due to the fact that generally the current spectrum contains a number of components with closely spaced frequencies, it is necessary to determine the frequency of the supply network as well as the rotational frequency with an inaccuracy not exceeding the value of ± 0.03 Hz. It is also necessary to have a spectrum resolution of at least $1/8$ Hz.
2. The measurement of the angular velocity and of the supply network frequency should be

carried out and averaged over the same time interval in which the current signal sample has been taken for spectrum analysis.

In the proposed measurement system this requirement has been met in such a way that the value of the angular speed and of the supply frequency is calculated on the basis of appropriate components in the same current spectrum that is further used in the searching of diagnostic components, as shown in Fig. 1.

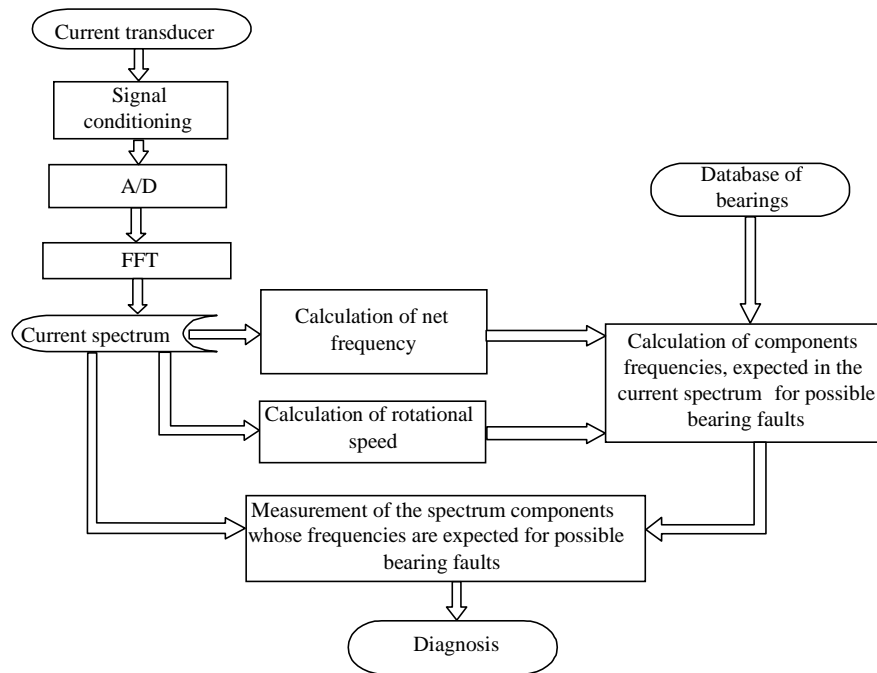

Fig. 1. The method of motor current measurement and analysis for diagnostic purposes.

3. The measurement system

The following assumptions for constructing the measurement system were chosen:

- for maintaining the necessary distance between the signal and noise of the system, the total noise of the system should not exceed – 100 dB and the range of measured frequencies should be of 20 Hz–3 kHz;
- to insure flexibility, the possibility of extension of software and further automatization of measurements, the measurement system should be computerized, based on virtual instruments. In the future, such a computerized system deprived of stationary equipment will allow field tests.

For realization of the computer measurement system, the hardware produced by National Instruments and software environment the LabVIEW of the same producer were chosen.

There was chosen the card type NI6052E, with a 16-bit converter. For this card the maximum positive error of measurement for the 10V range is ± 4 mV.

The assumed range of measured spectrum components values of -90 to -60 dB in the linear scale indicates the magnitude of 0,3 to 10 mV.

These are small values in comparison with the absolute measurement error. For reduction of the relative measurement error, the input voltage must be increased.

To find a solution, it has been proposed that the network signal component be reduced and that the remaining signal spectrum be next amplified and subjected to spectral analysis.

The filtering of the network component followed by the amplification of the signal should be performed on the analog side of system. The maximum possible value of the gain is



restricted by harmonic current components (3, 5 and 7 harmonic), the amplitudes of which are smaller than the first harmonic by about 40 dB.

After filtering the outstanding component and amplification of the rest of signal by 40 dB, the measured signals will be in the interval of 30 mV–1 V.

The object of testing was an asynchronous motor (the rated power 1,1 kW). A Hall-effect transducer was used as current converter while carrying out the tests. The current measurement system is presented in Fig. 2.

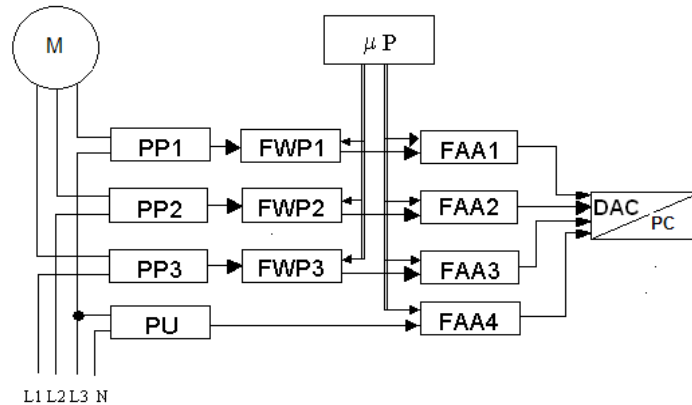

Fig. 2. Current measurement system for induction motor (where: M – induction motor; μP – microprocessor; PP1–PP3 – transducers for current measurements; PU – transducer for voltage measurements; FAA1-FAA4 – antialiasing filters; FWP1-FWP4 – narrow band filters; A/D – data acquisition card; PC – computer).

The system enables the motor current measurements to be made in all three phases, and voltage measurement in one supply net phase. In each measuring line there are antialiasing filters with variable frequency.

The current measurement lines contain notch-type filters with automatically tuned cut-off frequency to about 50Hz (frequency of motor supplying network) [7].

The program applied in the microprocessor performed the adjustment of the filter frequency according to actual supply net frequency. The measurements and adjustments are realized separately in each current phase. This enables the adjustments to be independent of the tolerance of components used for setting the filter frequency.

In each line there are amplifiers, which can increase the signal level by 40 dB. Next the signal is transferred to the measuring card situated in the computer of PC-class computer. Then, the system created in the LabVIEW environment carries out the spectrum analysis.

4. Experimental investigations

The object under test was a 1.1 kW three-phase motor with two pole pairs (synchronous speed $n_s = 25$ rps).

The investigations were carried out using motors with bearings having defects caused on purpose.

The assumption of a general thesis that all frequency components present in the spectrum of a motor with eccentric rotor can be modulated by the $\pm f_v$ and $\pm 2f_v$ frequency, where f_v is the frequency of oscillation of the air gap, permits to reduce the diagnostics to search for spectrum components with frequencies determined beforehand. The f_v frequencies for various types of bearing faults are given in [1].

From the experimental investigations, a set of 35 main current components was indicated for a faultless motor in the spectrum for frequency range of 0–200 Hz. Each of these 35 components can be the source of 4 new modulated components for a faulty bearing. In this

way 140 modulated components can be expected in the current spectrum for each type of bearing fault. Because of the great number of counted components, which is shown in Fig. 3, an algorithm for automatic spectrum analysis was designed.

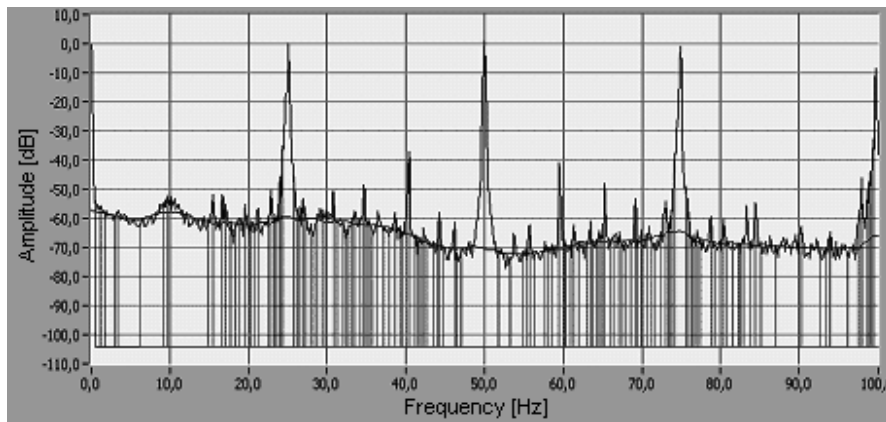

Fig. 3. The motor current spectrum with marked frequencies of components counted for 4 types of bearing faults.

The algorithm notes the amplitude of a spectrum component above the local noise level. In this way the result of a component’s measurement does not depend on the amplification of the measuring system.

Components whose amplitude defined in this way is smaller than 5 dB, are cancelled. Components whose frequencies are the same as components existing in a faultless motor are also cancelled. As a complex result of diagnostic measurement the sum of modulated components for 4 types of possible bearing faults (“control sum”) was chosen. The control sum was calculated as the sum of 64 spectrum components (from 140 modulated components) which are most sensitive to damages. The level of 700 dB of control sum was defined as the border between a correct and a faulty bearing. An example of diagnostic results in case of: a) faultless bearings, b) 3 different bearings (T1, T2, and T3) with damaged rolling elements are presented in Fig. 4.

Markers from L1 to L20 in the Figs 4, 5 and 6 define loads from idle running (L1) to 70% of rated power (L20).

Fig. 5 presents the probability of correct distinction between faulty and faultless bearings for different loads.

In the presented method it is also possible to recognize the type of a bearing fault by checking the control sum for each type of possible fault. Results of tests are presented in Fig. 6.

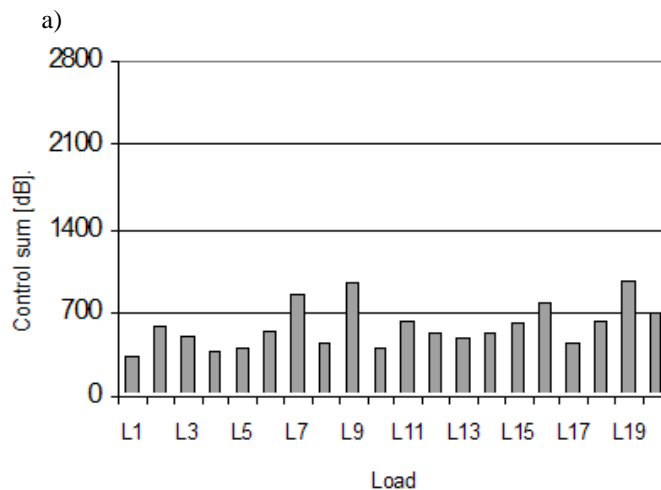

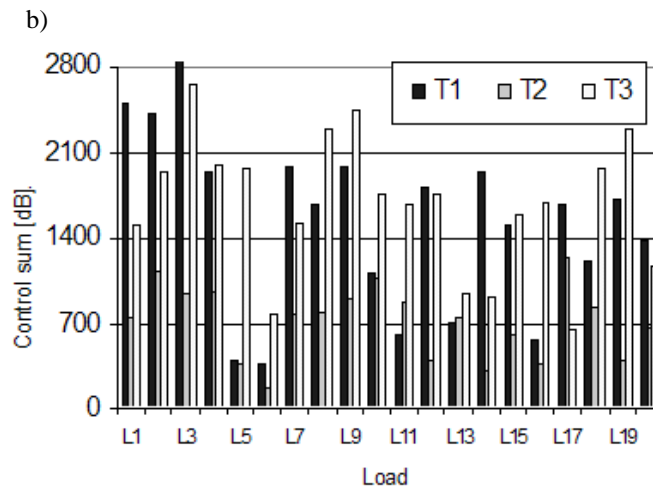

Fig. 4. Control sums for motor under different loads with bearings: a) faultless; b) damaged (T1, T2, T3).

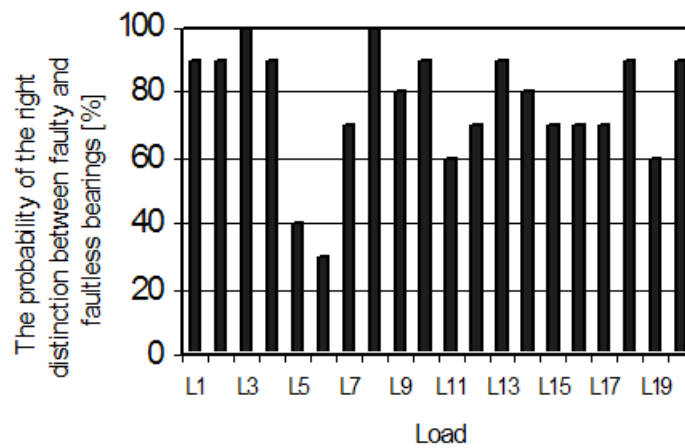

Fig. 5. The probability of the right distinction between faulty and faultless bearings.

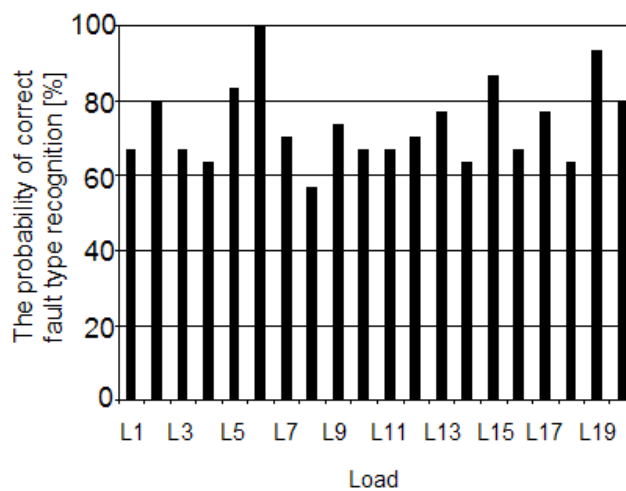

Fig. 6. The probability of the right distinction of the damage type.

5. Uncertainty

The precision of the measurement system was tested on specially designed computerized system. The final results of tests are shown in Fig. 7.

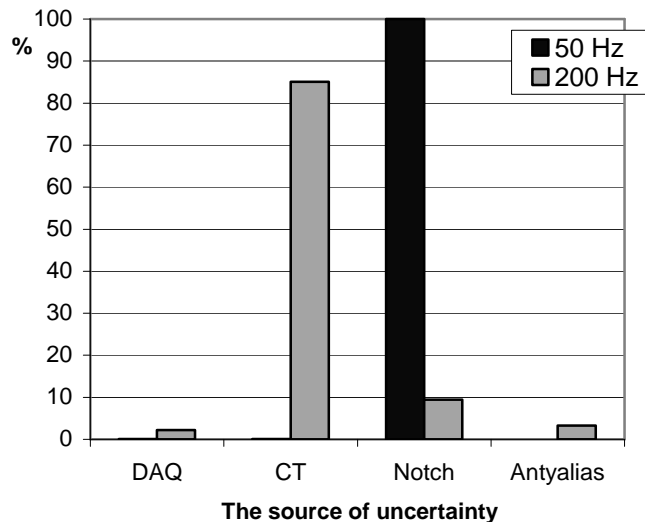

Fig. 7. Share of main uncertainty components in the complex uncertainty for two frequencies: 50 and 200 Hz
DAQ – data acquisition card, CT – current transducer, Notch – notch filter, Antyalias – antyalising filter.

The complex uncertainty of measurements does not exceed 10% of measured component value, which is enough for diagnostic purposes.

6. Conclusions

1. The new method makes allowance for a much larger group of spectral components involved in the investigations than applied at present. Owing to this fact it is possible to avoid erroneous diagnoses when single components disappear in the spectrum.
2. The measurement of the angular velocity and of the supply network frequency over the same time interval in which the current signal sample has been taken, give measurement results of characteristic frequencies conformable with theoretical calculations. In the proposed measurement system this result has been reached in such a way that the value of the angular speed and of the supply frequency is calculated on the basis of appropriate components in the very same current spectrum that is further used in the search for diagnostic components.
3. The probability of the right distinction between faulty and faultless bearings amounts to over 90% in the case of idle running motors and also those operating under insignificant load. With regard to motors operating under loads greater than 10% of the rated load, the probability of the right qualification falls to the level of 77%.
4. The correctness of distinguishing the type of damage was also investigated. The diagnosis was assumed to be correct if it conforms to the defects indicated by the standard system of the vibration diagnostics, of course, when other damages were not detected. The average probability of diagnostic correctness determined in this way reaches 70%. The probability that the system will identify correctly at least one existing defect is more than 90%.
5. Diagnostics of bearings, based on the analysis of the current spectrum becomes easier when the motor runs idle – the spectrum contains more diagnostic components with greater amplitudes above the noise level. This situation is contrary to that in diagnostics of squirrel-cages asymmetry based on an analysis of current.

References

- [1] Schoen, R.R., Habetler, T.G., Karman, F., Bartheld, R.G. (1995). Motor bearing damage detection using stator current monitoring. *IEEE T. Ind. Appl.*, 31, 1274–1279.
- [2] Yazici, B., Kliman, G.B. (1999). An adaptive statistical time-frequency method for detection of broken bars and bearing faults in motors using stator current. *IEEE T. Ind. Appl.*, 35(2), 442–452.
- [3] Kliman, G.B., Stein, J. (1990). Induction motor fault detection via passive current monitoring. In *Proceedings of ICEM, MIT*, Cambridge USA, 13–17.
- [4] Calis, H., Unsworth, P.J. (1999). Fault diagnosis in induction motors by motor current signal analysis. In *Proceedings of SDEMPED*, 237–241.
- [5] Schoen, R.R., Lin, B., Habetler, T.G., Schlag, J.H., Farag, S. (1994). An unsupervised, on line system for induction motor fault detection using stator current monitoring. *Conf. Rec. 29th IEEE-IAS Annu. Meeting*, 117–122.
- [6] Rusek, J., Swędrowski, L. (2003). Effect of the damage of bearing on current spectrum of induction machines. In *Proceedings of XXXIX International Symposium on Electrical Machines SME*. Gdansk, Poland, CD ROM.
- [7] Swędrowski, L. (2003). Diagnostics of induction motors by means of current supplying measurements. Machine Engineering. *Editorial Institution of the Wroclaw Board of Federation of Technical Societies NOT*, 3(1–2) Wroclaw, Poland.