

Data Integration from GPS and Inertial Navigation Systems for Pedestrians in Urban Area

K. Bikonis & J. Demkowicz

Gdansk University of Technology, Gdansk, Poland

ABSTRACT: The GPS system is widely used in navigation and the GPS receiver can offer long-term stable absolute positioning information. The overall system performance depends largely on the signal environments. The position obtained from GPS is often degraded due to obstruction and multipath effect caused by buildings, city infrastructure and vegetation, whereas, the current performance achieved by inertial navigation systems (INS) is still relatively poor due to the large inertial sensor errors. The complementary features of GPS and INS are the main reasons why integrated GPS/INS systems are becoming increasingly popular. GPS/INS systems offer a high data rate, high accuracy position and orientation that can work in all environments, particularly those where satellite availability is restricted.

In the paper integration algorithm of GPS and INS systems data for pedestrians in urban area is presented. For data integration an Extended Kalman Filter (EKF) algorithm is proposed. Complementary characteristics of GPS and INS with EKF can overcome the problem of huge INS drifts, GPS outages, dense multipath effect and other individual problems associated with these sensors.

1 INTRODUCTION

The GPS system is a part of a satellite-based navigation system. The fully operational GPS includes 24 or 28 active satellites approximately uniformly dispersed around six circular orbits with four or more satellites each. Theoretically, three or more GPS satellites will always be visible from most points on the earth's surface, and four or more GPS satellites can be used to determine an observer's position anywhere on the earth's surface 24 hours per day. The GPS receiver can offer positioning information with output rate between 1 and 10 Hz. However, the system performance depends largely on the signal environments. GPS uses the energy of the radio waves for obtaining the navigation parameters hence it is prone to jamming. Also the signal may get

obstructed in urban areas due to tall buildings and other obstacles [1-2].

In an INS system, the angular rate and specific force measurements from the Inertial Measurement Unit (IMU) are processed to yield the position, velocity and attitude solution. General, inertial IMU, which incorporates three-axis accelerometers and three-axis gyroscopes, can be used as positioning and attitude monitoring devices. Such systems can navigate autonomously and provide measurements at a higher data rate (e.g., 100 Hz). However, the system has to be initialized and calibrated carefully before application. Moreover, the sensor errors are growing unboundedly over time. The presence of residual bias errors may deteriorate the long-term positioning accuracy [3-4].

Due to the complimentary characteristics of GPS and INS, they are often integrated to obtain a complete and continuous navigation solution [5-7].

The inertial sensors used in IMU are made in MEMS (Micro Electro-Mechanical Systems) technology. MEMS technology enables miniaturization, mass production and cost reduction of many sensors. In particular, MEMS inertial sensors that include an acceleration sensor and an angular velocity sensor (gyroscope, or simply "gyro") are the most popular devices. Almost all MEMS acceleration sensors have a seismic mass and support spring made of silicon. The structure of MEMS gyros is somewhat similar to that of acceleration sensors – a mass supported by a spring is continuously vibrated in the device, and the Coriolis force generated by the applied angular velocity affects the movement of the mass (vibrating gyroscope). The mass in a MEMS device is very small, and therefore, the inertial forces acting on the mass, especially the Coriolis force, are also extremely small. Thus, the design of the circuit that measures the movement in mass due to the force is important in addition to the design of the mechanical structure. Recently MEMS inertial sensors have been built with an integrated circuit, with sensor structure on a single device chip [4].

A typical structure of a MEMS acceleration sensor is shown in Figure 1 [4], where a silicon mass is supported by silicon springs and the displacement of the mass due to acceleration is measured by capacitance change between the mass and fixed electrodes. Since the mass is very small and the displacement is also small, the resolution of the device is generally limited to around $0.1 \text{ mg Hz}^{-1/2}$.

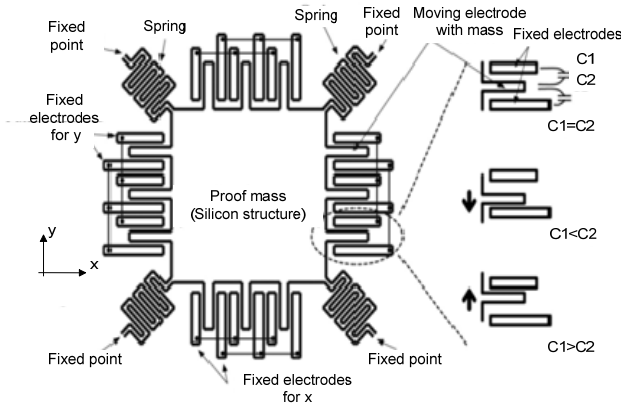

Figure 1. Structure of MEMS acceleration sensor (2-axis) [4].

The basic structure of MEMS gyroscopes is similar to acceleration sensors, i.e., a mass is supported by springs. The main difference in operation is that the angular velocity is obtained by measuring the Coriolis force on the vibrating mass. Thus, the movement of the mass should have at least two degrees of freedom. The device is shown in Figure 2 [4].

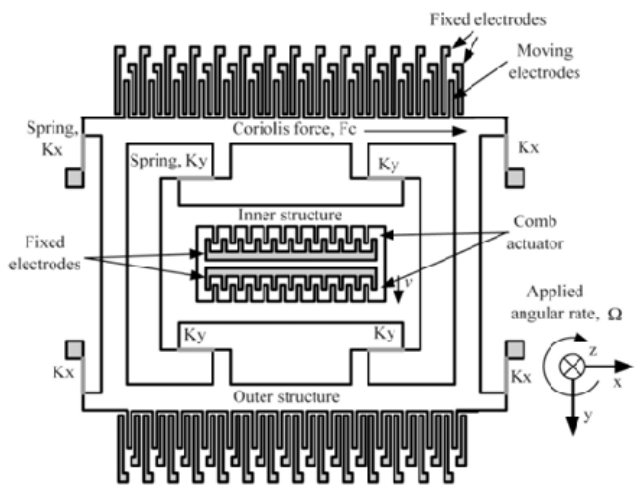

Figure 2. Conceptual structure of a MEMS gyroscope [4].

Inertial sensors have numerous applications. INS is a self-contained system that integrates three acceleration and three angular velocity components with respect to time and transforms them into the navigation frame to deliver position, velocity, and attitude components. The three orthogonal linear accelerations are continuously measured through three-axis accelerometers while three gyroscopes monitor the three orthogonal angular rates in an inertial frame of reference. In general, IMU, which incorporates three-axis accelerometers and three-axis gyroscopes, can be used as positioning and attitude monitoring devices. However, INS cannot operate appropriately as a stand-alone navigation system.

The presence of residual bias errors in both the accelerometers and the gyroscopes, which can only be modeled as stochastic processes, may deteriorate the long-term positioning accuracy. Hence, the INS/GPS data integration is the desirable solution to provide navigation system that has better performance in comparison with either a GPS or an INS stand-alone system.

2 IMU DESCRIPTION

We use a commercially available IMU, model MTi-G from Xsens Technologies. Figure 3 shows this sensor. Its size is 58x58x22 mm (WxLxH), and it weighs 50 grams.

The IMU has three orthogonally-oriented accelerometers, three gyroscopes, three magnetometers and GPS receiver. The accelerometers and gyroscopes are MEMS solid state with capacitive readout, providing linear acceleration and rate of turn, respectively. Magnetometers use a thin-film magnetoresistive principle to measure the earth magnetic field. The performance of each individual MEMS sensor within the MTi IMU are summarized in table 1 and GPS receiver in table 2.

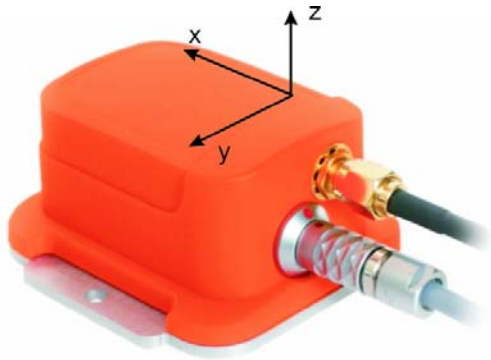

Figure 3. MTi-G Xsens IMU with annotated sensor Cartesian coordinates.

The MTi-G sensor has a built-in algorithm that provides the absolute heading and attitude of the unit, which is expressed as the rotation matrix R_{GS} . It can be used to directly transform the readings from the sensor (S) to the global (G) Cartesian coordinates frames. The typical absolute orientation errors are summarized in table 3. Performance is quite good whenever the earth magnetic field is not disturbed, for example by metallic objects, power lines, personal computers, or any device containing electro-magnetic motors.

Table 1. Performance of individual sensors in Xsens IMU.

	A	G	M
Axes	3	3	3
Full Scale FS	±50 m/s ²	±300 °/s	± 750 mGuass
Linearity	0.1% of FS	0.2% of FS	0.2% of FS
Bias stability	0.02 m/s ²	1 °/s	0.1 mGuass
Bandwidth	30 Hz	40 Hz	10 Hz
Max update rate	512	512	512

A – accelerometers, G – gyroscopes, M – magnetometers

Table 2. GPS receiver parameters.

Receiver type	50 channels L1 frequency, C/A code
GPS update rate	4 Hz
Start-up time cold start	29 s
Tracking sensitivity	-160 dBm
Timing Accuracy	50ns RMS

Table 3. Performance of attitude and heading as provided Xsens fusion algorithm in matrix R_{GS}

Static accuracy (roll/pitch)	< 0.5°
Static accuracy (heading)*	< 1°
Dynamic accuracy	2° RMS
Angular resolution	0.005 °

*in homogeneous magnetic environment

3 NAVIGATION ALGORITHMS USING DATA FROM IMU

The conventional IMU navigation algorithm is to integrate the gyroscopes and accelerometers data (Figure 4). However, the position values obtained by this method are reliable for only a short period of time. This is due to the accelerometer's inherent drift error as well as the gyro rate drift error, which means that when double integration of the acceleration measurements, the drift error is also accumulated over time and increases dramatically with time. So the estimated position will be far away from the actual position.

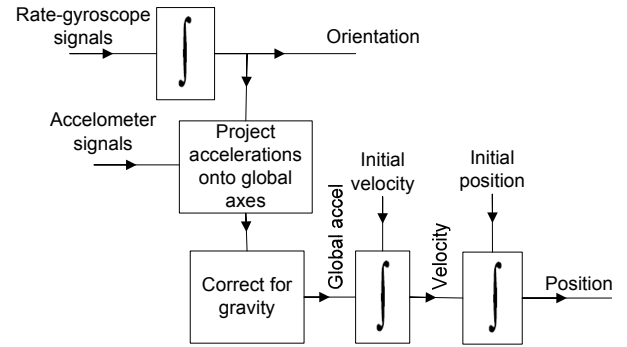

Figure 4. Conventional IMU navigation algorithm.

Other IMU navigation method pedestrian-oriented can be based on a step detection algorithm and use orientation information directly from IMU. There are several step detection algorithms that have been proposed by researches in the literature [3, 8].

The algorithm implemented for step detection consist of the following four steps [8]. First step, compute the magnitude of the acceleration a_i for each sample i , like

$$a_i = \sqrt{a_{x_i}^2 + a_{y_i}^2 + a_{z_i}^2}. \quad (1)$$

Second step, computes the local acceleration variance, to remove gravity, like

$$\sigma_{a_i}^2 = \frac{1}{2w+1} \sum_{j=i-w}^{i+w} (a_j - \bar{a}_j)^2, \quad (2)$$

where \bar{a}_j is a local mean acceleration value, is computed like

$$\bar{a}_j = \frac{1}{2w+1} \sum_{q=i-w}^{i+w} a_q, \quad (3)$$

and w defines the size of the averaging window in samples. Third step, uses two thresholds. First (T_1) is applied to detect the swing phase (B_{1i}), whereas the second (T_2) applied to detect the stance phase (B_{2i}) in a single step while walking.

$$B_{1i} = \begin{cases} T_1 & \sigma_{a_i} > T_1 \\ 0 & \text{otherwise} \end{cases}. \quad (4)$$

$$B_{2i} = \begin{cases} T_2 & \sigma_{a_i} < T_2 \\ 0 & \text{otherwise} \end{cases}. \quad (5)$$

Fourth step, is detected in sample i when a swing phase ends and stance phase starts. Figure 5 shows details of this step detection method. Step detection also is possible using data from gyroscope and magnetometer [3].

4 ALGORITHM FOR INS AND GPS DATA INTEGRATION

The INS/GPS data integration algorithm is based on Extended Kalman Filter (EKF) usage [10, 11]. EKF uses Taylor series, where the idea of a linear approximation to describe a function in the neighborhood of some point by a linear function is applied. The algorithm works in a two-step prediction/correction process. In the prediction step, the Kalman filter produces estimates of the current state variables. Because of the recursive nature of the algorithm, it can be run in real time. The present input measurements and the previously calculated state is used; no additional past information is required [12]. The very idea is presented in the Figure 6 where \hat{x}_{k-1}^- , \hat{x}_k^- are a priori and a posteriori system state, P_{k-1}^- , P_k^- are a priori and a posteriori covariance matrix, H is measurement matrix, K_k is Kalman gain, R , Q are process and state variance of the system, z_k is measurement matrix, A is process model.

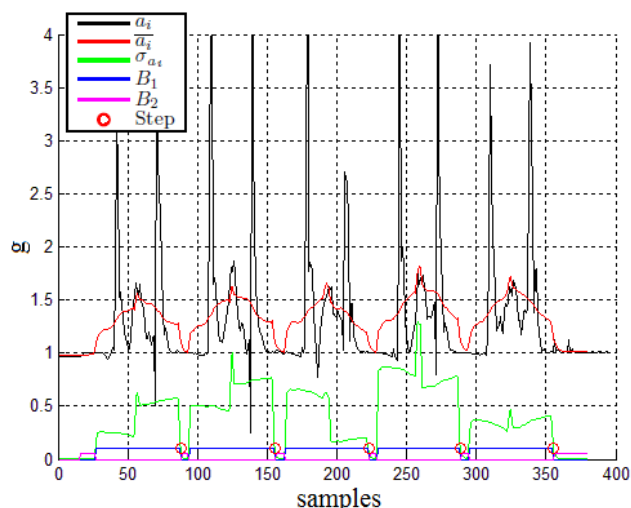

Figure 5. Conventional IMU navigation algorithm.

Also it is necessary to estimate the Stride Length (SL) at every detected step in order to calculate the total forward movement of a person while walking. SL depends on the person, its leg length, and its walking speed and the nature of the movements during walking, and etc. The algorithm proposed by Weinberg [9] assumes that SL is proportional to the bounce, or vertical movement, of the human hip. This hip bounce is estimated from the largest acceleration differences at each step. The algorithm implemented for SL estimation consists of the following three steps [8]. First step, compute the magnitude of accelerations a_i , as in eq. 1. Second step, Low-Pass filter this signal (\bar{a}_i). In particular we use a filter of order 6 and cut-off frequency at 5 Hz. Third step, estimate the SL using Weisberg expression.

$$SL_k = K \left\{ \max_{\sim j=(i_{(k)} \pm w)} \bar{a}_j - \min_{\sim j=(i_{(k)} \pm w)} \bar{a}_j \right\}^{1/4} \quad (6)$$

where the maximum and minimum operations are applied over the filtered accelerations in a window of size $2w+1$ around the sample $i_{(k)}$ corresponding to the k stance detection. K is a constant that has to be selected experimentally or calibrated. Table 4 shows examples results for $K=1$. In the Weinberg methodology, using a fixed K value, is valid for accurately estimating SL even at different walking speed.

Table 4. Results for Stride Length (SL) estimation algorithm.

	Step1	Step2	Step3	Step4	Step5
SL for K=1	1.17m	1.26m	1.25m	1.29m	1.41m

Navigation method based on step detection algorithm and use orientation information directly from IMU is a good solution for estimating human trajectories. However, the drift of position obtained by this method is proportional to the travelled distance, changes in walking speed (K is a constant), changes in walking direction, data quality from IMU (accelerometers, gyroscopes and magnetometers) and etc.

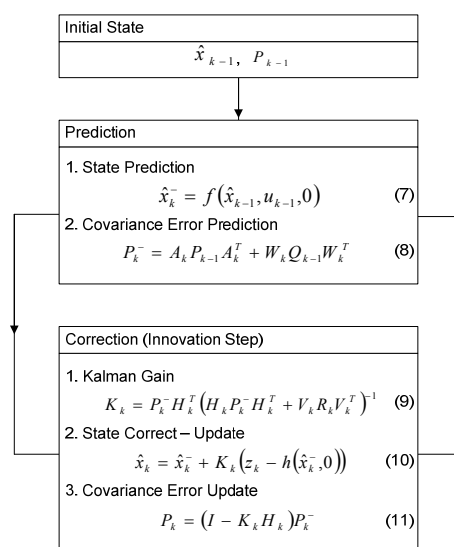

Figure 6. EKF sensor data integration algorithm diagram.

Prediction can be described as follows (7) and (8) in the Figure 6, where $f(x, u, w)$ is nonlinear function, which uses a previous filter state as well as control impact and the process noise. A_k (or A^J) is a Jacobian, f with respect to x , W_k (or W^J) is a Jacobian, f with respect to w function. Where A and W are follows:

$$A_{[i,j]}^J = \frac{\delta f_{[i]}}{\delta x_{[j]}} (\hat{x}_{k-1}, u_{k-1}, 0), \quad (12)$$

$$W_{[i,j]}^J = \frac{\delta f_{[i]}}{\delta x_{[j]}} (\hat{x}_{k-1}, u_{k-1}, 0). \quad (13)$$

And correction is applied as follows (9), (10) and (11) in the Figure 6, where H_k (or H^J) is Jacobian, derivative of the function h with respect to x , V_k (or V^J) is Jacobian as well, function h derivative of with respect to v and $h(x, v)$ is nonlinear function representing state and measurement relation. Jacobians H and V can be expressed as follows:

$$H_{[i,j]}^J = \frac{\delta h_{[i]}}{\delta x_{[j]}}(\tilde{x}_k, 0), \quad (14)$$

$$V_{[i,j]}^J = \frac{\delta h_{[i]}}{\delta x_{[j]}}(x_k, 0), \quad (15)$$

where:

$$x_k = f(x_{k-1}, u_{k-1}, 0). \quad (16)$$

All Jacobians ought to be recalculated in every step iteration, when the GPS/IMU model is generated.

The state estimate vector consists of 20 elements

$$\hat{x} = [x \ y \ z \ v_x \ v_y \ v_z \ q \ b_x \ b_y \ b_z \ \varphi_x \ \varphi_y \ \varphi_z \ \varphi_{bx} \ \varphi_{by} \ \varphi_{bz} \ g]^T \quad (11)$$

initialized with:

$$\hat{x} = [000,000,1000,0.0010.0010.001, \quad (12)$$

$$000,0.0010.0010.001,0]^T$$

where $x \ y \ z$ is location [m], $v_x \ v_y \ v_z$ is velocity [m/s], q is quaternion vector, $b_x \ b_y \ b_z$ is bias [G], $\varphi_x \ \varphi_y \ \varphi_z$ is rotation phase [rad], $\varphi_{bx} \ \varphi_{by} \ \varphi_{bz}$ is rotation biases, g is gravitation.

The observation covariance matrix R is diagonal matrix consisting of GPS position error (5 m) and velocity error (0.5 m/s) in direction x, y, z , while the covariance noise diagonal matrix equals:

$$Q = \text{diagonal}([0.50.50.5,0.50.50.5, \quad (13)$$

$$0.000010.000010.000010.00001,0.010.010.01,$$

$$0.0010.0010.001,0.0010.0010.001,0.01])$$

5 RESULTS

The purpose of this study is to track the position of a

pedestrian walking outside. One foot of the pedestrian is mounted with an IMU, which is used to measure the acceleration and angular rate of the walking foot. The GPS module is attached to a straight pole with the GPS antenna on the top of it so that the GPS position signal can be obtained more easily. The pedestrian localization is achieved by integrating the inertial and GPS information. Figure 7 shows IMU and GPS antenna localization on the body.

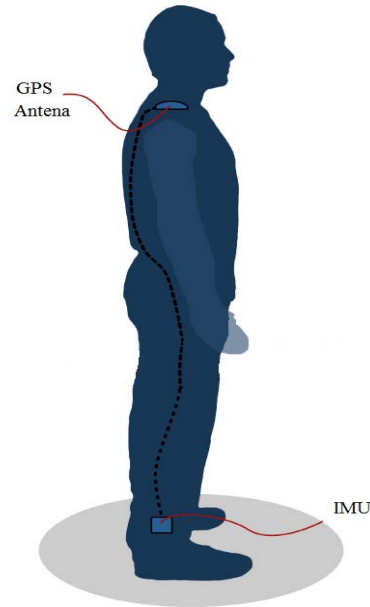

Figure 7. IMU and GPS antenna localization on the body.

The IMU/GPS based pedestrian localization algorithm is firstly implemented when a pedestrian is walking along a 20m×20m square. The result of the IMU/GPS algorithm using EKF is shown in figure 8.

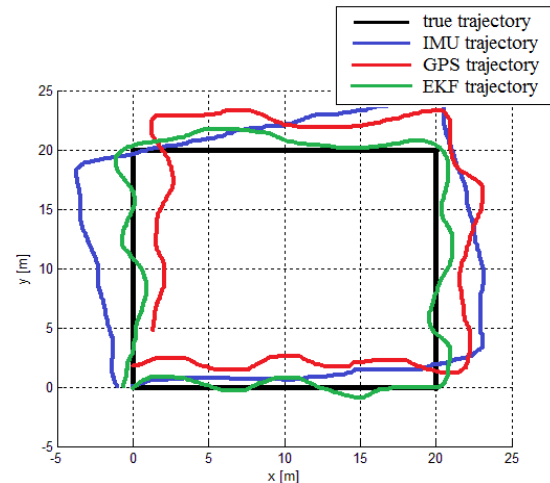

Figure 8. The pedestrian trajectory represented by different methodologies for 20mx20m square.

Another test was conducted in an environment shown in figure 9 and the results of the IMU/GPS algorithm using EKF is shown in figure 10.

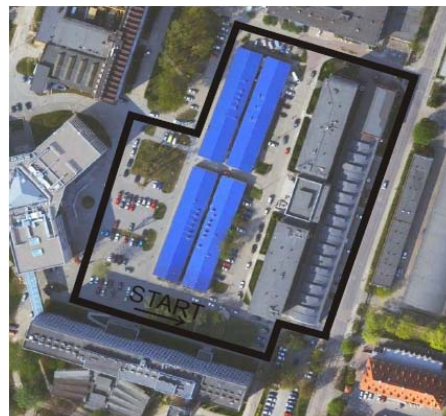

Figure 9. The environment test area.

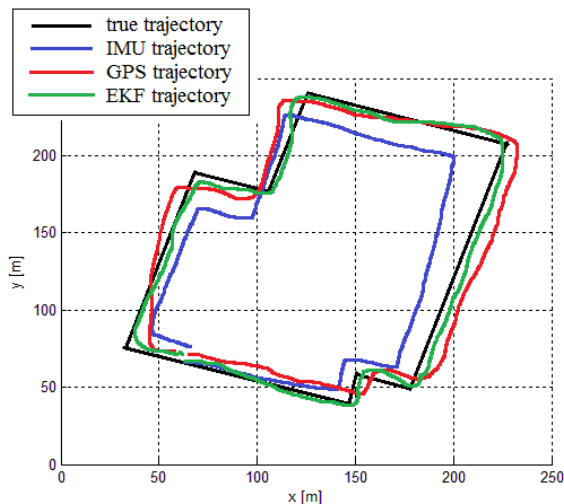

Figure 10. The pedestrian trajectory represented by different methodologies for environment.

It is obvious that EKF corrected trajectory is more accurate than the trajectory calculated by IMU and GPS separately. Result for EKF is nearly GPS trajectory when GPS errors are between 1 to 5 meters.

6 CONCLUSIONS

In this paper, we proposed an EKF to integration of GPS and INS systems data for pedestrians location in urban environment. Obtained results show that EKF algorithm is more accurate and robust, than algorithms using data from GPS and INS systems separately. However, the situation of long-term GPS outage is not considered in this paper. Our future work will focus on the improvement of the localization accuracy in long-term operations.

REFERENCES

- [1] Malleswaran M., Angel Deborah S., Manjula S., Vaidehi V. 2010. Integration of INS and GPS Using Radial Basis Function Neural Networks for Vehicular Navigation. *11th Int. Conf. Control, Automation, Robotics and Vision*. Singapore, Malaysia.
- [2] Grewal M. S., Weill L. R. Andrews A. P. 2001. Global positioning system and inertial navigation, Wiley. New York, USA.
- [3] Feliz R., Zalama E., Garcia-Bermejo J. G. 2009. Pedestrian tracking using inertial sensors. *Journal of Physical Agents* Vol. 3, No. 1.
- [4] Maenaka K. 2008. MEMS inertial sensors and their applications. *5th international conference on networked sensing systems*. Kanazawa, Japan.
- [5] Abdelkrim N. Nabil A. 2010. Robust INS/GPS sensor fusion for UAV localization using SDR nonlinear filtering. *IEEE Sensors Journal* Vol. 10, No. 4.
- [6] Grejner-Brzezinska D. A., Toth Ch. K., Sun H., Wang X., Rizos Ch. 2011. A Robust Solution to High-Accuracy Geolocation: Quadruple Integration of GPS, IMU, Pseudolite, and Terrestrial Laser Scanning. *IEEE Transactions on Instrumentation and Measurement* Vol. 60, No. 11.
- [7] Hide Ch., Moore T., Smith M. 2004. Adaptive Kalman Filtering algorithms for integrating GPS and low cost INS. *Position Location and Navigation Symposium*. Monterey, USA.
- [8] Jimenez A.R., Seco F., Prieto C., Guevara J. 2009. A comparison of pedestrian dead-recording algorithms using a low-cost MEMS IMU. *6th International Symposium on Intelligent Signal Processing*. Budapest, Hungary.
- [9] Weinberg H. 2002. Using the ADXL202 in Pedometer and Personal Navigation Applications. *Analog Devices AN-602 application Note*.
- [10] Ling Ch., Housheng H. 2012. IMU/GPS Based Pedestrian Localization. *2012 4th Computer Science and Electronic Engineering Conference (CEEC)*. University of Essex, UK.
- [11] Leutenegger S., Siegwart R. Y. 2012. A Low-Cost and Fail-Safe Inertial Navigation System for Airplanes. *2012 IEEE Conference on Robotics and Automation*. Saint Paul, Minnesota, USA.
- [12] Kedzierski J. 2007. Filtr Kalmana – zastosowania w prostych układach sensorycznych. *Koło naukowe robotyków KoNaR*. Wrocław University of Technology, Poland.