

## Digital microcontroller for sonar waveform generator

Aleksander SCHMIDT, Jan SCHMIDT

Gdansk University of Technology  
Faculty of Electronics, Telecommunications and Informatics  
Narutowicza 11/12, 80-233 Gdańsk, Poland  
aschmidt@eti.pg.gda.pl

*Generating sounding signals is essential for the operation of active sonar. The system should be highly reliable. This can be achieved through architecture, communication between the devices, and a well-designed and self-testing software. The system presented in the article is responsible for the generation of hydroacoustic sounding signals, and ensures proper interaction between power amplifiers and power supplies. Thanks to its structure, the system ensures a very stable generation of many complex sounding signals in the form of linear or hyperbolic frequency modulated pulses (up or down), continuous transmission wave with increasing frequency and others. It is used in the mine-countermeasure sonar, but can also be used in other types of hydroacoustic systems which require complex sounding signals. The article describes possible technical solutions and sounding signals.*

**Keywords:** Direct Digital Synthesis, digital transmitter, transmitter controller

### 1. Introduction

Over the last thirty years, the frequencies and types of sounding signals used in mine-countermeasure sonar have seen a lot of change. The initial sounding signals with a rectangular envelope and single frequency, have been replaced with broadband frequency modulation signals. To minimise the Doppler effect on detection conditions, hyperbolic frequency modulation (HFM) signals are used. When searching for mines, objects are detected with signals whose frequency ranges from 30 to 200kHz and from 200 to 600 kHz when classifying objects [3].

## 2. Concept of a hydroacoustic sounding signal generator module

The hydroacoustic sounding signal generator was developed for a mine-countermeasure sonar. Installed on-board a Polish Navy ship, the sonar was modernised by the Gdansk University of Technology. The reason for designing a new sounding signal generator was to support the implementation of modern hydroacoustic sounding signals. Thanks to the project, an embedded generator was developed which works well with the parameters of the existing hydroacoustic sonar array.

As regards the size, a 19 inch and 3U high cassette was planned. As a consequence, the size of the printed circuit board is 220 mm x 100 mm.

## 3. Signal generation

The design allowed for two types of sounding signals, i.e. signal with linear frequency modulation (LFM) or hyperbolic frequency modulation (HFM). If an HFM signal is used, we can significantly reduce the negative Doppler effect on detecting the echo off a target. The LFM signal is described with the formula [1]:

$$f_l(t) = \sin \left[ 2\pi \left( f_0 - \frac{B}{2} + \frac{B}{2T} t \right) t \right], \quad 0 < t < T \quad (1)$$

where  $f_0$  is the carrier frequency and  $B$  is the bandwidth.

The HFM signal is expressed with this formula:

$$f_h(t) = \sin \left[ 2\pi \left( \frac{f_0^2}{B} + \frac{B}{4} \right) T \ln \left( 1 - \frac{2B}{(2f_0+B)T} t \right) \right], \quad 0 < t < T \quad (2)$$

Figures 1 and 2 present the simulated signals in time domain and their periodograms. The results were obtained in the Matlab simulation environment.

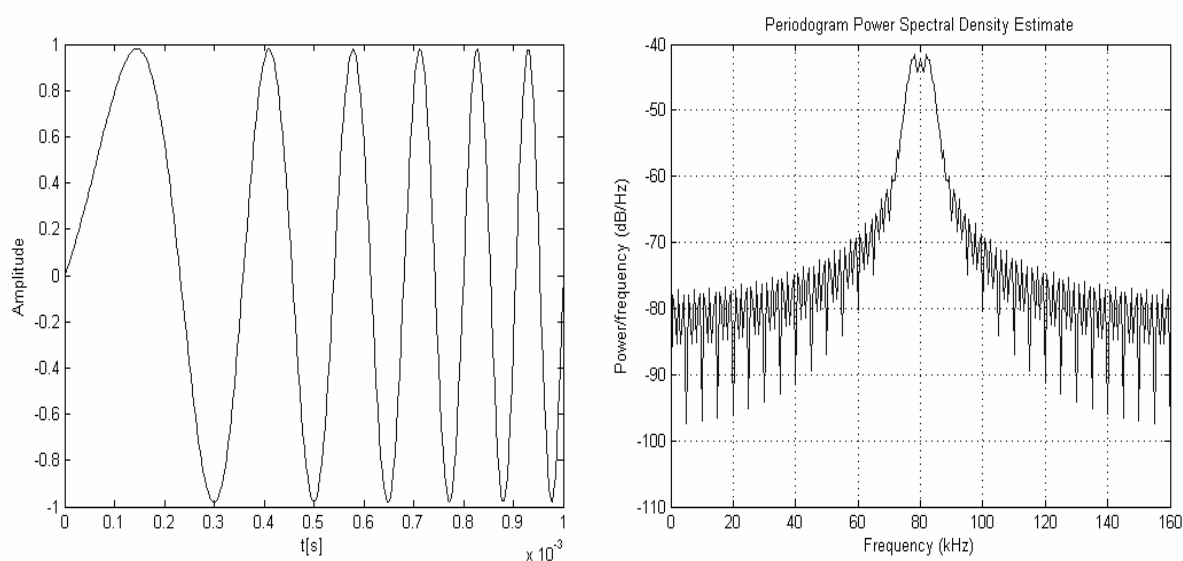

Fig. 1. LFM signal generated in Matlab environment.

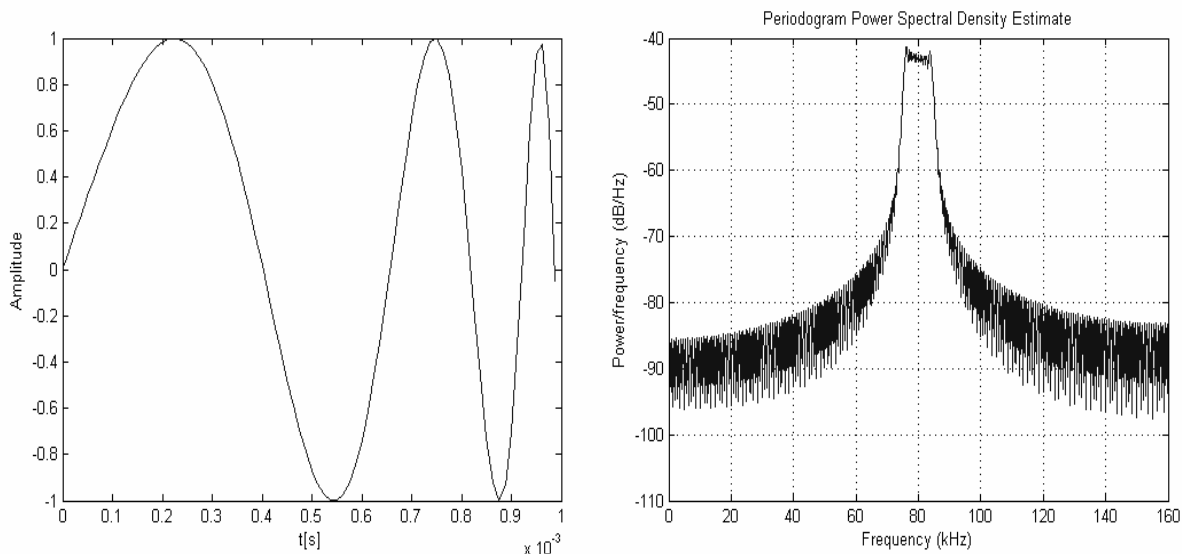

Fig. 2. HFM signal generated in Matlab environment.

Signals were generated using Direct Digital Synthesis (DDS) by Analog Devices AD9954. It is a modern way to generate signals in a variety of shapes and frequencies [5]. With its in-built capacity, it can generate sinusoidal constant frequency signals (CW), or linear frequency modulation signals (LFM) up and down. The equipment also allows for signal complexity [2]. To generate more complex signals, the system’s internal memory can be used. Signals are reproduced by reading the value of the desired frequency from the subsequent memory cells and sending them to a phase accumulator. The newly obtained value from the phase accumulator is summed with the signal’s initial phase, and passed on to the block for converting the phase into amplitude. The final step is to provide the value of the generated signal’s amplitude to a digital-to-analogue converter,[4]. The diagram of the operation is shown in Fig. 3.

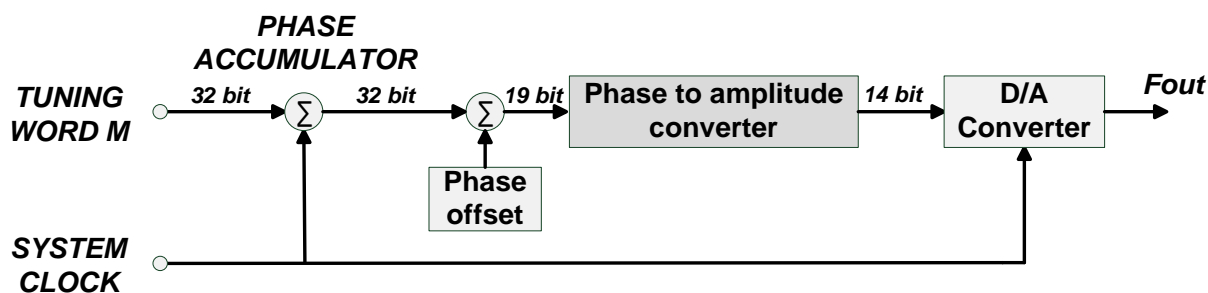

Fig. 3. Components of a direct digital synthesizer.

For the purposes of the mine-countermeasure sonar project, an LFM signal was used with one of three durations, of 1ms, 2ms and 5ms. The length of the sounding pulse depends on the range chosen by the operator of the underwater acoustic station. The width of the generated signal band is 10 kHz ranging from 75 to 85kHz. The Figure below shows the spectrum of an LFM signal which is 1ms long. The time form of the signal for a signal

shifted to baseband is 1-11kHz. They are oscilloscope records recorded before a low-pass filter.

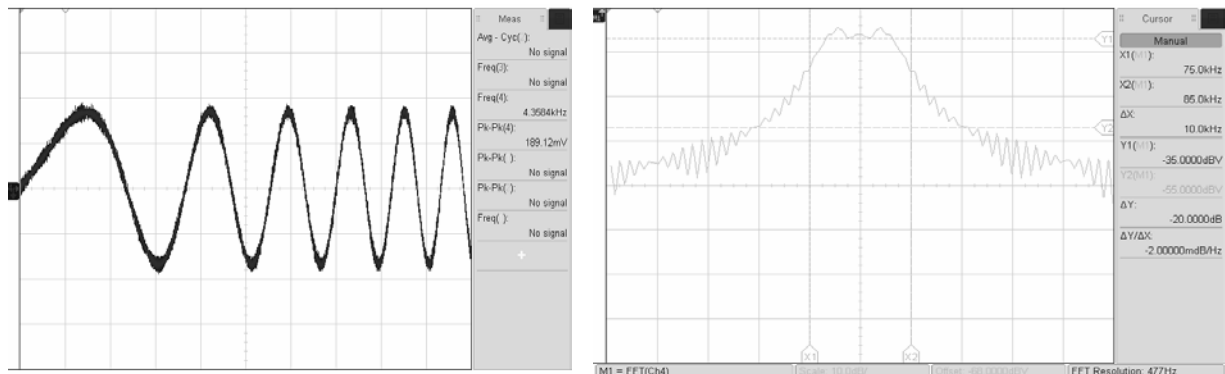

Fig. 4. LFM signal from the generator.

Communication with the AD9954 is done via an SPI interface. This helps to change signal shape quickly before it is generated. Once the hydroacoustic sounding signal is generated, it is passed on to the block where the array is protected from continuous wave. The objective of the block is to ensure that signal duration is not too long, and reduce the band of the signal. This is a very important functionality which protects the sonar's array from failure. The block is performed by the equipment which eliminates any of the software errors. The block is made using the D flip-flop and monostable multivibrators.

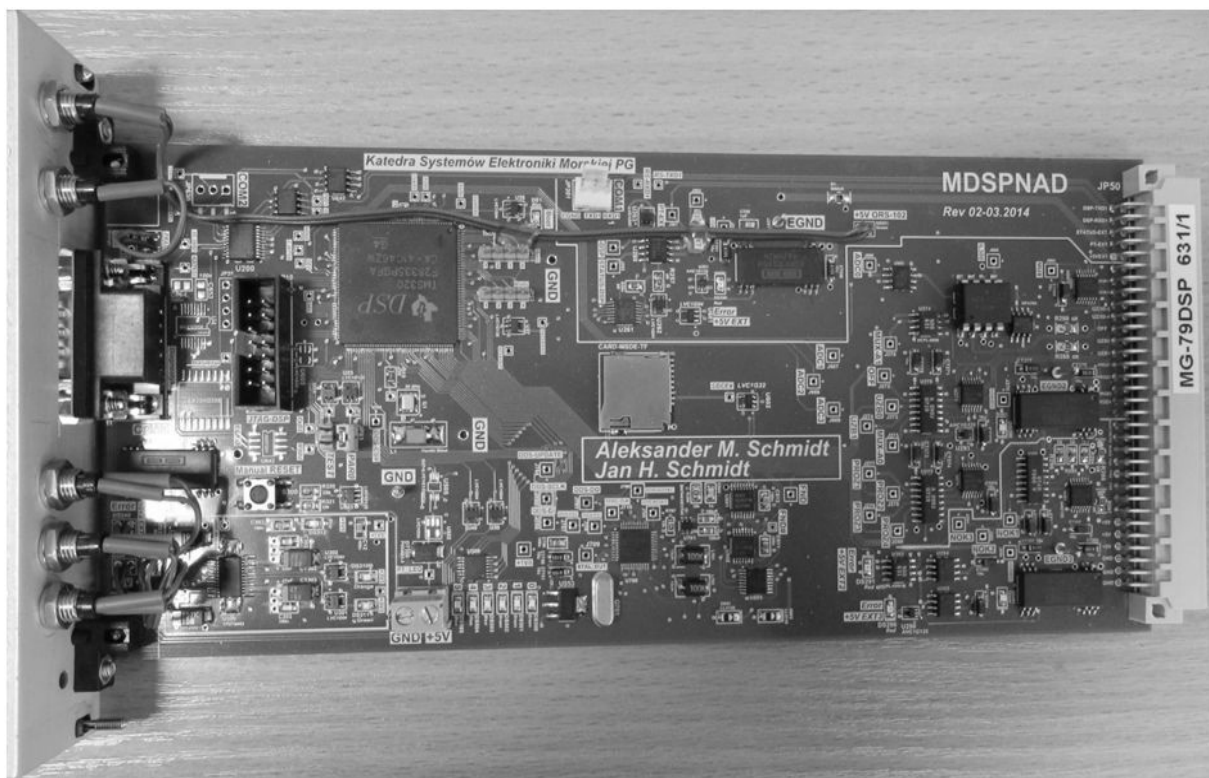

Fig. 5. View of the controller's printed circuit board.

### 4. Architecture of the sounding signal generator

To control the sounding signal generation, a 32 bit microcontroller by Texas Instruments TMS320F28335 was used. It is a high performance processor which can conduct 150 million instructions per second (MIPS), with a 150 MHz clock using Harvard architecture. The microcontroller has 512 KB of Flash memory, and 68 KB of static RAM. The project used some of its peripheral devices such as: digital inputs and outputs, and an analogue-to-digital converter with a 14 bit resolution. Two asynchronous serial ports operating in the RS232C standard to communicate with the Sonar Console and service devices were used. Optionally, a CAN serial connection was prepared. It can operate in CAN A or B. The module of the SPI synchronous serial port was used to communicate with the DDS AD9954 which is an Analog Devices generator. To help create complicated sounding pulses, recording and reading can be done on both the SD memory card and external memory Flash EN25HQ256 by cFeon. To avoid differences in the generator's and its other devices' mass potential difference, all digital and analogue inputs and communication buses have galvanic isolation. These blocks are represented in Figure 6.

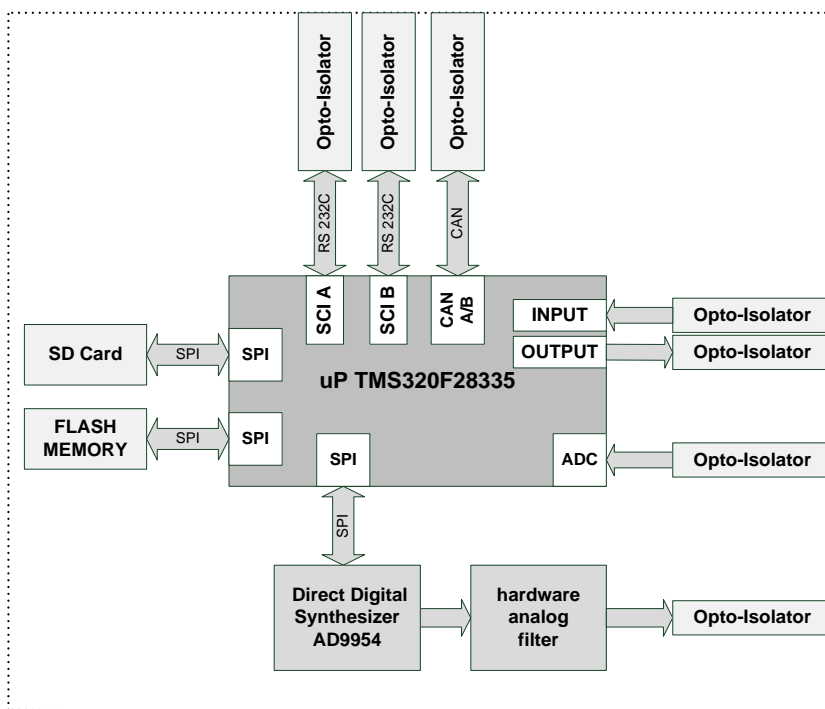

Fig. 6. Architecture of sounding signal generator.

### 5. Communication with external devices

The generator is able to communicate with external devices via the RS232C serial connection, CAN interface, and a number of input and output ports. In specific time slots the module measures voltage at power amplifier capacitors, which are the source of energy.

The generator has two independent serial connections in the RS232C standard. The first connection is at the connector on the cassette's backplane side. It supports communications

with the Operator Console. The connection carries information about the length of a selected transmitting pulse, and the power of sounding pulse emission. The second serial connection is on the generator module's front plate and is used for maintenance. This is shown in Figure 5. In the service mode, the generator responds to frames that are sent via the RS232C service connection only. The module comes with additional functionality in the service mode to ensure a wide range of transmitter testing possibilities. The RS232C asynchronous serial connection's hardware is sturdy, and makes sure that both devices can communicate. To improve the credibility of the data being transmitted, an algorithm was introduced designed to count the control sums of the frames being sent. This is not required when the CAN connection is used. The controllers of this bus already have a built-in mechanism for counting, checking, and repeating frames that were wrongly sent. Thanks to the connection it is possible to operate in a network consisting of several devices.

With an analogue-to-digital converter which is part of the generator's processor, we can measure the voltage of the capacitors that are the energy sources. The measurement informs the generator of the capacitors' charge levels. It will then use this information to decide whether a sounding signal can be emitted. If the energy level is not sufficient, it will make the capacitors charge. Once they are charged, the generator will allow the sounding pulse to be emitted. Likewise, when capacitor voltage is too high, the generator makes the capacitors get rid of the unwanted power until the right level is achieved.

Capacitors are charged and discharged, and transmitter power supply and power amplifiers are switched on and off, via the generator processor's input and output ports.

## 6. Galvanic isolation

Sonars tend to have a dispersed architecture, with their elements placed in rooms separated by some distance. Sonar devices and wiring are frequently placed in direct proximity to strong electromagnetic fields generated, for example, by electric engines. The sonar's architecture and operating environment are prone to interference. To prevent this, the generator's module includes voltage stabilisers with galvanic isolation, and all input and output signals have galvanic isolation.

Texas Instruments DCR010505U, DCR010503U stabilisers with galvanic isolation were used. To provide galvanic isolation of the RS232C serial connection signals, ISO 7221 was used. Galvanic isolation of discrete inputs and outputs uses HCPL-090J and HCPL-0900, and that of the analogue signal uses HCNR-201.

## 7. Functional diagram of the software

Once the module is on, the first task is to configure peripheral devices and set them on stand-by to deliver the settings sent from the Sonar Console. The main programme is responsible for carrying out the setting of the DDS generators, power supply and Power Amplifier Modules. One of the time systems/timer is used to measure the power levels of Power Amplifier Modules. The second one controls the length of the signals being generated, and the third one has an auxiliary function. Interruption caused by falling edge of the Beginning Transmission line checks the status of power level and, if found correct, a sounding pulse is generated. Interruption of rising edge of the Beginning Transmission line starts the power supply, and a procedure for measuring the power levels of Power Amplifier Modules. This is presented in Figures 7 and 8.

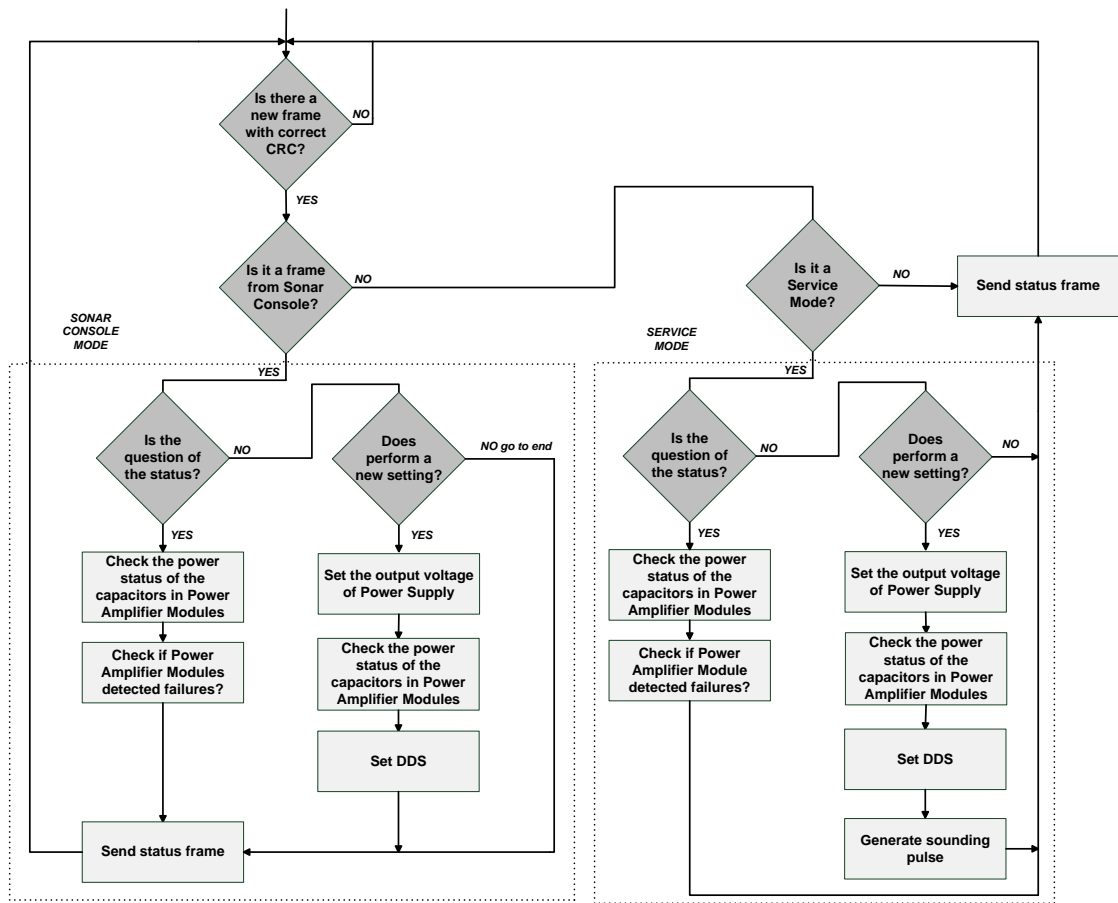

Fig. 7. Block diagram of the main sounding signal generator programme.

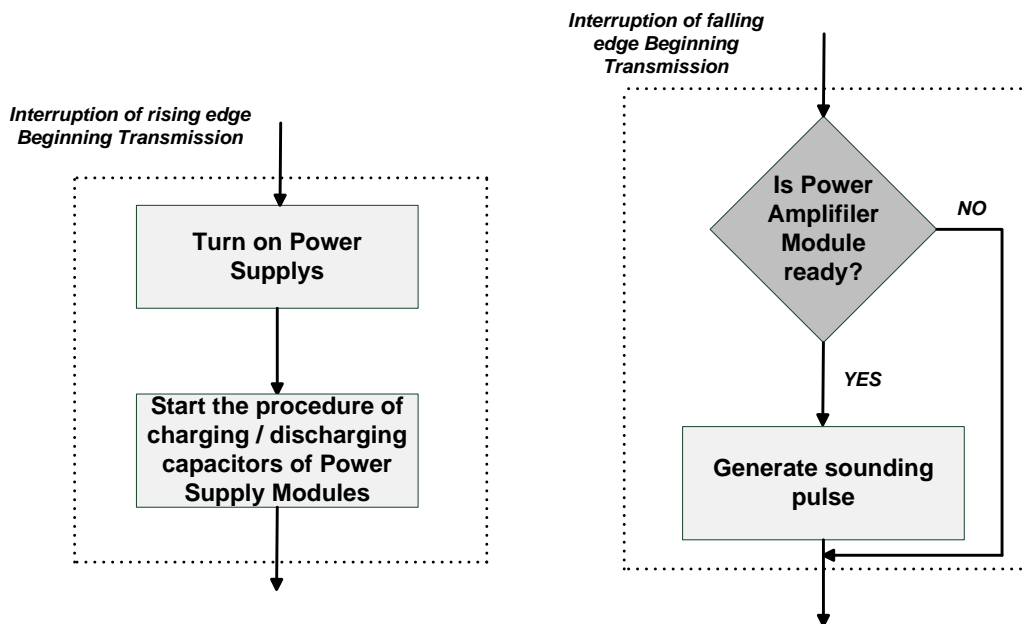

Fig. 8. Block diagram of interruptions that trigger sounding signal generation.

## 8. Conclusion

The hydroacoustic signal generator has been successfully tested in a laboratory, and in the field, i.e. on board a mine-countermeasure ship.

It has demonstrated its reliability, and stability of operation under difficult conditions, on board the ship. During two years of operation, there have been no complaints from the users.

With its advanced solutions, the generator can be used in other devices with some software adjustments.

## References

- [1] J. Marszal, Experimental Study of Silent Sonar, Archives of Acoustics, Vol. 39, No.1, pp. 103-115, 2014.
- [2] J. Marszal, Digital Signal Processing Methods Implemented in Polish Navy Sonar Modernization, Polish Maritime Research, Vol. 21, No 2. pp. 65-75, 2014.
- [3] J. Marszal, Implementation of Contemporary Technologies in the Modernisation of Naval Sonars, Hydroacoustics Vol. 16, pp. 167-180, 2013.
- [4] AD9954 Direct Digital Synthesizer Data Sheet (Rev.B), Analog Devices.  
<http://www.analog.com/media/en/technical-documentation/data-sheets/AD9954.pdf>
- [5] A Technical Tutorial on Digital Signal Synthesis, Analog Devices.  
[http://www.analog.com/media/cn/training-seminars/tutorials/450968421DDS\\_Tutorial\\_rev12-2-99.pdf](http://www.analog.com/media/cn/training-seminars/tutorials/450968421DDS_Tutorial_rev12-2-99.pdf)