



# Journal of Applied Sciences

ISSN 1812-5654

**science**  
alert

**ANSI***net*  
an open access publisher  
<http://ansinet.com>

## Elastic and Inelastic Multi-Storey Buildings Under Earthquake Excitation with the Effect of Pounding

<sup>1</sup>S. Mahmoud and <sup>2</sup>R. Jankowski

<sup>1</sup>Graduate School of Science and Technology, Hirosaki University, Hirosaki, 036-1861, Japan

<sup>2</sup>Faculty of Civil and Environmental Engineering, Gdansk University of Technology,  
Ul. Narutowicza 11/12, 80-233 Gdansk, Poland

---

**Abstract:** In this study, an investigation is carried out to analyze the difference in considering adjacent multi-storey buildings to behave elastically or inelastically on the response of structures under earthquake excitation with the effect of pounding. In the study, both structures are modelled as four-storey systems and the nonlinear viscoelastic model is used to simulate pounding force during collisions at different storey levels. Three different ground motion records with different Peak Ground Accelerations (PGA) are applied to conduct the numerical simulations. The study is carried out for two cases: (1) two adjacent buildings are considered to be elastic and (2) two adjacent buildings are considered to be inelastic. A formulation of the equation of motion for two elastic and inelastic buildings is presented. The influence of the gap distance on the structural response (peak displacement, acceleration and pounding force) is also investigated. The results clearly show that modelling the colliding buildings to behave inelastically is really essential in order to obtain accurate structural response under earthquake excitation.

**Key words:** Pounding, earthquakes, buildings, elastic systems, inelastic systems

---

### INTRODUCTION

The destructive nature of earthquakes has always been important to structural engineers. The reports on damage after strong earthquakes show that the effect of structural pounding is often one of the reasons for damage. The earthquake that struck Alaska (1964), San Fernando (1971), Mexico City (1985), Loma Prieta (1989) and Kobe (1995) are clear examples of the serious seismic hazard due to pounding. Bertero (1985) reported that pounding was present in about 40% of 330 collapsed buildings during the 1985 Mexico City earthquake and in 15% of all cases it led to collapse.

Seismic pounding occurs between adjacent buildings with different structural characteristics, which are insufficiently separated. The differences in geometrical and/or material properties result in the out-of-phase oscillations and significant differences in the responses increase the probability of impacts. One of the key issues is to estimate the required separation distance to avoid pounding of adjacent structures. Four different expressions (Valles and Reinhorn, 1996; Penzien, 1997; Lopez Garcia, 2004) have been used in building codes to calculate the minimum separation distance required to

prevent structural interactions. One of them considers the equivalent to the absolute sum of adjacent buildings' maximum displacements. The second specifies the minimum gap size without considering the dynamic properties of adjacent structures. Instead, a coefficient multiplied by the building height is needed to evaluate the critical gap distance. The third expression specifies a fixed distance for construction considerations and the last one uses the square root of sum of squares taking into account the fact that the maximum displacements in the structures will not occur at the same time.

Because of the complexity of the pounding phenomenon, most of the past studies on structural pounding incorporated elastic models of buildings assuming that the ground motion causes deformations that do not exceed the elastic limit. In addition, the buildings were often idealized as Single-Degree-of-Freedom (SDOF) systems (Maison and Kasai, 1992; Chau and Wei, 2001; Chau *et al.*, 2003). One of the studies on the seismic response of adjacent structures, which permitted the evaluation of the nonlinear behaviour of buildings subjected to pounding, was conducted by Athanassiadou and Penelis (1985). Anagnostopoulos (1988) carried out a more detailed study of pounding of

adjacent buildings in a row modelled as SDOF nonlinear systems. Pantelides and Ma (1998) considered the dynamic behavior of damped SDOF elastic and inelastic structural systems with one-sided pounding during an earthquake using the Hertz contact model to capture pounding. Muthukumar and Des Roches (2006) studied the pounding of adjacent structures modelled as elastic and inelastic SDOF systems using different pounding models. Jankowski (2006a) proposed the idea of impact force response spectrum for two adjacent elastic and inelastic structures modelled as SDOF systems.

In order to conduct numerical simulations of the responses of colliding buildings under earthquake excitation, a number of different impact force models have been used. Among them, the linear and nonlinear viscoelastic models (Anagnostopoulos, 1988; Jankowski, 2005) are the most attractive since they allow us to simulate the dissipation of energy during collisions. Mahmoud *et al.* (2008) confirmed the accuracy of the nonlinear viscoelastic model in capturing the pounding force through a comparison based on different ground motion records with different Peak Ground Accelerations (PGA). On the other hand, it is known that the use of the linear viscoelastic model (Anagnostopoulos, 1988) results in tension force just before separation, which is considered as a major shortcoming of the model for pounding simulation. Mahmoud (2008) proposed a modified version of the linear viscoelastic model to simulate pounding without inducing the sticky tensile force, yet this modified model requires further investigations.

Besides the fact that the study on earthquake-induced structural pounding has been recently much advanced, the comparison between the pounding-involved responses of buildings modelled as elastic and inelastic systems has not been conducted. Moreover, in the numerical analyses, the elastic pounding force models have often been used. Therefore, the aim of this study is to conduct a comparative study in order to verify the importance of the necessity of nonlinear modelling of structural behavior. In the study, buildings are modelled as multi-degree-of-freedom systems and the nonlinear viscoelastic model is used to simulate impact force during collisions. Different gap distances between structures exposed to different ground motion excitations are considered in the study.

**EQUATION OF MOTION**

Let us consider the models of four-storey buildings shown in Fig. 1. For  $i = (1,2,3,4)$  and  $j = (5,6,7,8)$  let  $m_i, c_i$  and  $k_i$  be the masses, damping and stiffness coefficients for the left and the right building, respectively. Let us first

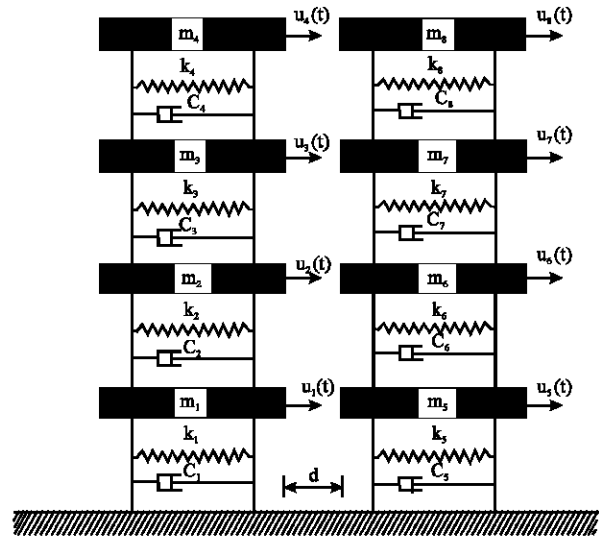

Fig. 1: Model of colliding four-storey buildings

assume that the two buildings remain in the linear elastic range and hence they do not yield under earthquake excitation. In such a case, the coupling equation of motion for the two buildings shown in Fig. 1 can be written as Eq. 1:

$$\begin{pmatrix} M^l & 0 \\ 0 & M^r \end{pmatrix} \begin{pmatrix} \ddot{U}^l \\ \ddot{U}^r \end{pmatrix} + \begin{pmatrix} C^l & 0 \\ 0 & C^r \end{pmatrix} \begin{pmatrix} \dot{U}^l \\ \dot{U}^r \end{pmatrix} + \begin{pmatrix} K^l & 0 \\ 0 & K^r \end{pmatrix} \begin{pmatrix} U^l \\ U^r \end{pmatrix} + \begin{pmatrix} F \\ -F \end{pmatrix} = - \begin{pmatrix} M^l & 0 \\ 0 & M^r \end{pmatrix} \begin{pmatrix} I \\ I \end{pmatrix} \ddot{U}_g \quad (1a)$$

$$M^l = \begin{pmatrix} m_1 & 0 & 0 & 0 \\ 0 & m_2 & 0 & 0 \\ 0 & 0 & m_3 & 0 \\ 0 & 0 & 0 & m_4 \end{pmatrix}, M^r = \begin{pmatrix} m_5 & 0 & 0 & 0 \\ 0 & m_6 & 0 & 0 \\ 0 & 0 & m_7 & 0 \\ 0 & 0 & 0 & m_8 \end{pmatrix}, F = \begin{pmatrix} F_{15}(t) \\ F_{26}(t) \\ F_{37}(t) \\ F_{48}(t) \end{pmatrix} \quad (1b)$$

$$C^l = \begin{pmatrix} c_1 + c_2 & -c_2 & 0 & 0 \\ -c_2 & c_2 + c_3 & -c_3 & 0 \\ 0 & -c_3 & c_3 + c_4 & -c_4 \\ 0 & 0 & -c_4 & c_4 \end{pmatrix}, C^r = \begin{pmatrix} c_5 + c_6 & -c_6 & 0 & 0 \\ -c_6 & c_6 + c_7 & -c_7 & 0 \\ 0 & -c_7 & c_7 + c_8 & -c_8 \\ 0 & 0 & -c_8 & c_8 \end{pmatrix} \quad (1c)$$

$$K^l = \begin{pmatrix} k_1 + k_2 & -k_2 & 0 & 0 \\ -k_2 & k_2 + k_3 & -k_3 & 0 \\ 0 & -k_3 & k_3 + k_4 & -k_4 \\ 0 & 0 & -k_4 & k_4 \end{pmatrix}, K^r = \begin{pmatrix} k_5 + k_6 & -k_6 & 0 & 0 \\ -k_6 & k_6 + k_7 & -k_7 & 0 \\ 0 & -k_7 & k_7 + k_8 & -k_8 \\ 0 & 0 & -k_8 & k_8 \end{pmatrix} \quad (1d)$$

$$U^l = \begin{pmatrix} U_1(t) \\ U_2(t) \\ U_3(t) \\ U_4(t) \end{pmatrix}, \dot{U}^l = \begin{pmatrix} \dot{U}_1(t) \\ \dot{U}_2(t) \\ \dot{U}_3(t) \\ \dot{U}_4(t) \end{pmatrix}, \ddot{U}^l = \begin{pmatrix} \ddot{U}_1(t) \\ \ddot{U}_2(t) \\ \ddot{U}_3(t) \\ \ddot{U}_4(t) \end{pmatrix} \quad (1e)$$

$$U^r = \begin{pmatrix} U_5(t) \\ U_6(t) \\ U_7(t) \\ U_8(t) \end{pmatrix}, \dot{U}^r = \begin{pmatrix} \dot{U}_5(t) \\ \dot{U}_6(t) \\ \dot{U}_7(t) \\ \dot{U}_8(t) \end{pmatrix}, \ddot{U}^r = \begin{pmatrix} \ddot{U}_5(t) \\ \ddot{U}_6(t) \\ \ddot{U}_7(t) \\ \ddot{U}_8(t) \end{pmatrix} \quad (1f)$$

where,  $M^l, C^l, K^l$  and  $M^r, C^r, K^r$  are the mass, damping and stiffness matrices of the left and the right building, respectively;  $U^l, \dot{U}^l, \ddot{U}^l$  and  $U^r, \dot{U}^r, \ddot{U}^r$  denote the displacement, velocity and acceleration vectors of the left and the right structure, respectively;  $F$  is a vector containing the forces due to impact;  $I$  is a vector with all its elements equal to unity and  $\ddot{U}_g$  is the earthquake acceleration.

If the two buildings are assumed to be inelastic under the considered earthquake excitation, the coupling equation of motion can be expressed in Eq. 2 as:

$$\begin{pmatrix} M^l & 0 \\ 0 & M^r \end{pmatrix} \begin{pmatrix} \dot{U}^l \\ \dot{U}^r \end{pmatrix} + \begin{pmatrix} C^l & 0 \\ 0 & C^r \end{pmatrix} \begin{pmatrix} \dot{U}^l \\ \dot{U}^r \end{pmatrix} + \begin{pmatrix} R^l \\ R^r \end{pmatrix} + \begin{pmatrix} F \\ -F \end{pmatrix} = - \begin{pmatrix} M^l & 0 \\ 0 & M^r \end{pmatrix} \begin{pmatrix} I \\ I \end{pmatrix} \ddot{U}_g \quad (2a)$$

$$R^l = \begin{pmatrix} R_1(t) - R_2(t) \\ R_2(t) - R_3(t) \\ R_3(t) - R_4(t) \\ R_4(t) \end{pmatrix}, R^r = \begin{pmatrix} R_5(t) - R_6(t) \\ R_6(t) - R_7(t) \\ R_7(t) - R_8(t) \\ R_8(t) \end{pmatrix} \quad (2b)$$

where,  $R^l$  and  $R^r$  are vectors consisting of the system inelastic storey restoring forces for the left and the right building, respectively;  $R_i(t) = k_i(U_i(t) - U_{i-1}(t))$ ,  $R_i(t) = k_i(U_j(t) - U_{j-1}(t))$  for the elastic range and  $R_i(t) = F_{yi}$ ,  $R_j(t) = F_{yj}$  for the plastic range, where  $F_{yi}$  and  $F_{yj}$  are the storey yield strengths.

In the study, the nonlinear viscoelastic model is used to simulate the pounding force during impact  $F_{ij}(t)$  between the storeys of the two adjacent buildings, which is based on the following formula in Eq. 3 (Jankowski, 2005, 2008):

$$F_{ij}(t) = \bar{\beta} \delta_{ij}^3(t) + \bar{c}_{ij}(t) \delta_{ij}(t); \quad \delta_{ij}(t) > 0 \quad (\text{approach period of collision})$$

$$F_{ij}(t) = \bar{\beta} \delta_{ij}^3(t); \quad \delta_{ij}(t) \leq 0 \quad (\text{restitution period of collision}) \quad (3)$$

where,  $\delta_{ij}(t)$  is the relative displacement:  $\delta_{ij}(t) = (U_j(t) - U_i(t) - d)$ ,  $\dot{\delta}_{ij}(t)$  is the relative velocity,  $\bar{\beta}$  is the impact stiffness parameter and  $\bar{c}_{ij}$  is the impact element's damping, which can be calculated as in Eq. 4 (Jankowski, 2005):

$$\bar{c}_{ij}(t) = 2\bar{\xi} \sqrt{\bar{\beta} \delta_{ij}(t) \frac{m_i m_j}{m_i + m_j}} \quad (4)$$

where,  $\bar{\xi}$  is an impact damping ratio related to a coefficient of restitution  $e$ , which can be defined as in Eq. 5 (Jankowski, 2006b):

$$\bar{\xi} = \frac{9\sqrt{5}}{2} \frac{1 - e^2}{e(e(9\pi - 16) + 16)} \quad (5)$$

## NUMERICAL STUDY

A comprehensive study is conducted in order to investigate the influence of modelling structural behaviour using either elastic or inelastic systems on the response of buildings with different separation distances under different ground motions. The El Centro (1940), Cape Mendocino (1992) and Kobe (1995) earthquake records (Fig. 2) are considered to examine the seismic response of the two buildings. The PGA levels of the above earthquakes are 0.34, 0.59 and 0.82 g, respectively (g is the acceleration of gravity). Different separation distances are considered to examine the influence of the gap distance on the peak structural displacements, accelerations and pounding forces. The study is carried out for two cases: (1) two four-storey buildings are considered to be elastic and (2) two four-storey buildings are considered to be inelastic.

In the study, we compare the Maximum Elastic Responses (MER) (i.e., displacements, accelerations and pounding forces) with the responses obtained considering the buildings to behave inelastically (MIR). The difference between the results of elastic behavior and the results of inelastic one is assessed by calculating the Normalized Error (NE) according to the formula in Eq. 6 (Jankowski, 2005):

$$NE = \frac{\|MIR - MER\|}{\|MIR\|} \times 100\% \quad (6)$$

**Properties of the structures:** In the present study, two adjacent four-storey buildings are considered (Fig. 1). The mass values as well as the stiffness and damping parameters are assumed to be the same for all storeys of each structure. The mass of the storey of the left building is equal to  $25 \times 10^3$  kg, whereas each storey of the right building has the mass of  $10^6$  kg. The storey stiffness is equal to  $3.46 \times 10^6$  N m<sup>-1</sup> and  $2.215 \times 10^9$  N m<sup>-1</sup> for the left and the right building, respectively. The damping ratio for both buildings is taken as 5%. For the above values of structural parameters the fundamental natural elastic periods of the structures have been calculated as equal to 1.2 and 0.3 sec for left and the right building, respectively. In the case of the inelastic response, the storey yield force for each storey of the left building is set to be  $1.369 \times 10^5$  N, whereas each storey of the right building yields when the

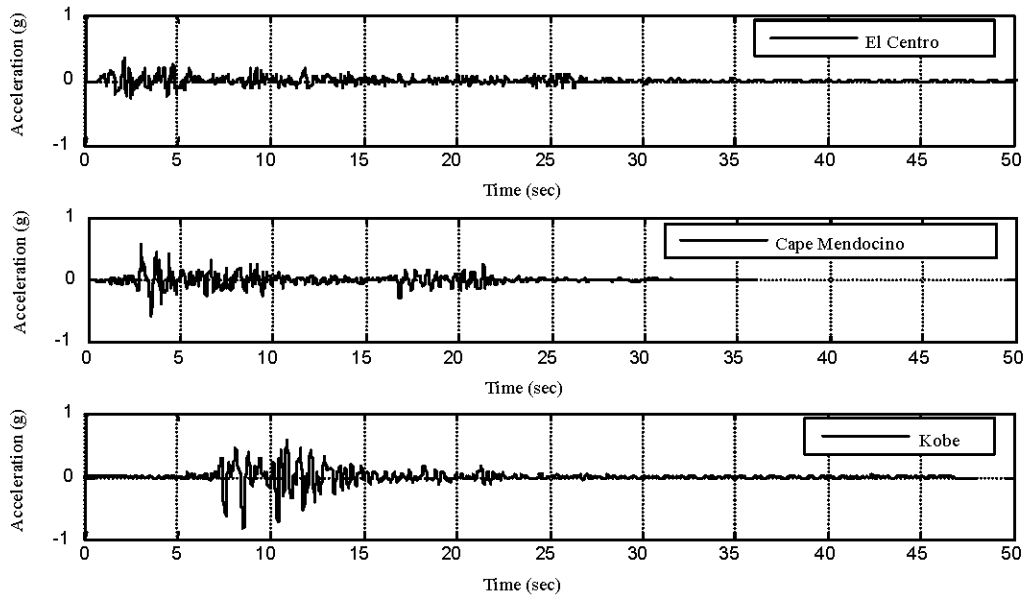

Fig. 2: Acceleration time histories of the El Centro (1940), Cape Mendocino (1992) and Kobe (1995) ground motion records (PEER Strong Motion Database: <http://peer.berkeley.edu/smcat/>)

force is equal to  $1.589 \times 10^7$  N. The parameters considered in the study make the left building to be lighter and more flexible when compared with the right structure, which is heavier and stiffer.

In the numerical analysis, the following values of parameters of the nonlinear viscoelastic pounding force model are used:  $\bar{p} = 2.75 \times 10^9 \text{ N m}^{-3/2}$ ,  $\bar{\xi} = 0.35$  ( $e = 0.65$ ) (Jankowski, 2008).

**Solution of equation of motion:** The coupling equation of motion (1) is solved in the incremental form using Implicit Runge-Kutta (IRK) methods (Chen and Mahmoud, 2008; Mahmoud and Chen, 2008) with two stage Burrage coefficients and step size of 0.001 sec. Moreover, we use the slanting Newton method (Chen *et al.*, 2000) to solve the system of nonsmooth equations in each iteration of the IRK method. On the other hand, Newmark's step-by-step method is used to solve the coupling equation of motion (2) with a constant time step size of 0.001 sec. In addition, we use the constant average acceleration approach (i.e.,  $\gamma = 0.5$ ,  $\beta = 0.25$ ) to ensure high degree of numerical stability. The numerical simulations are performed using MATLAB 7.0 software on a Dell PC with 2 MB memory and 800 MHz.

**Response analysis:** Here, pounding of two adjacent buildings modelled as discrete systems shown in Fig. 1, with either elastic or inelastic structural behavior, is studied. First, the numerical analysis is conducted for the value of the gap size between the structures equal to 0.04 m. The results of this analysis in the form of the

displacement and pounding force time histories for both buildings under the El Centro (1940), Cape Mendocino (1992) and Kobe (1995) earthquake records are shown in Fig. 3-5. The responses of the elastic systems are significantly different comparing to the responses of the inelastic ones (Fig. 3a,b, 5a,b). This concerns especially the left building, which is lighter and more flexible. In the case of this structure modelled as inelastic system, the first collision with the heavier and stiffer right building results in substantial movement into the opposite direction including entering into the yielding range. This movement is so big that the structures do not come into contact for the second time and the permanent deformation of the left structure can be observed (Fig. 3b, 4b, 5b). It can also be seen from the figures that the values of peak pounding forces and the number of impacts are larger in the elastic case as compared with the inelastic one. Moreover, in some cases (Fig. 5), the lower storeys of the elastic systems come into contact with each other, while in the case of the inelastic systems collisions between lower storeys do not take place.

Further analysis is carried out for different values of the gap size between colliding structures in order to investigate the influence of the separation distance on the pounding-involved structural response. The results of this analysis showing the peak displacements, accelerations and pounding forces for elastic and inelastic systems under the El Centro (1940), Cape Mendocino (1992) and Kobe (1995) earthquake records are presented in Fig. 6-8. The peak responses are considerably reduced for all the ground

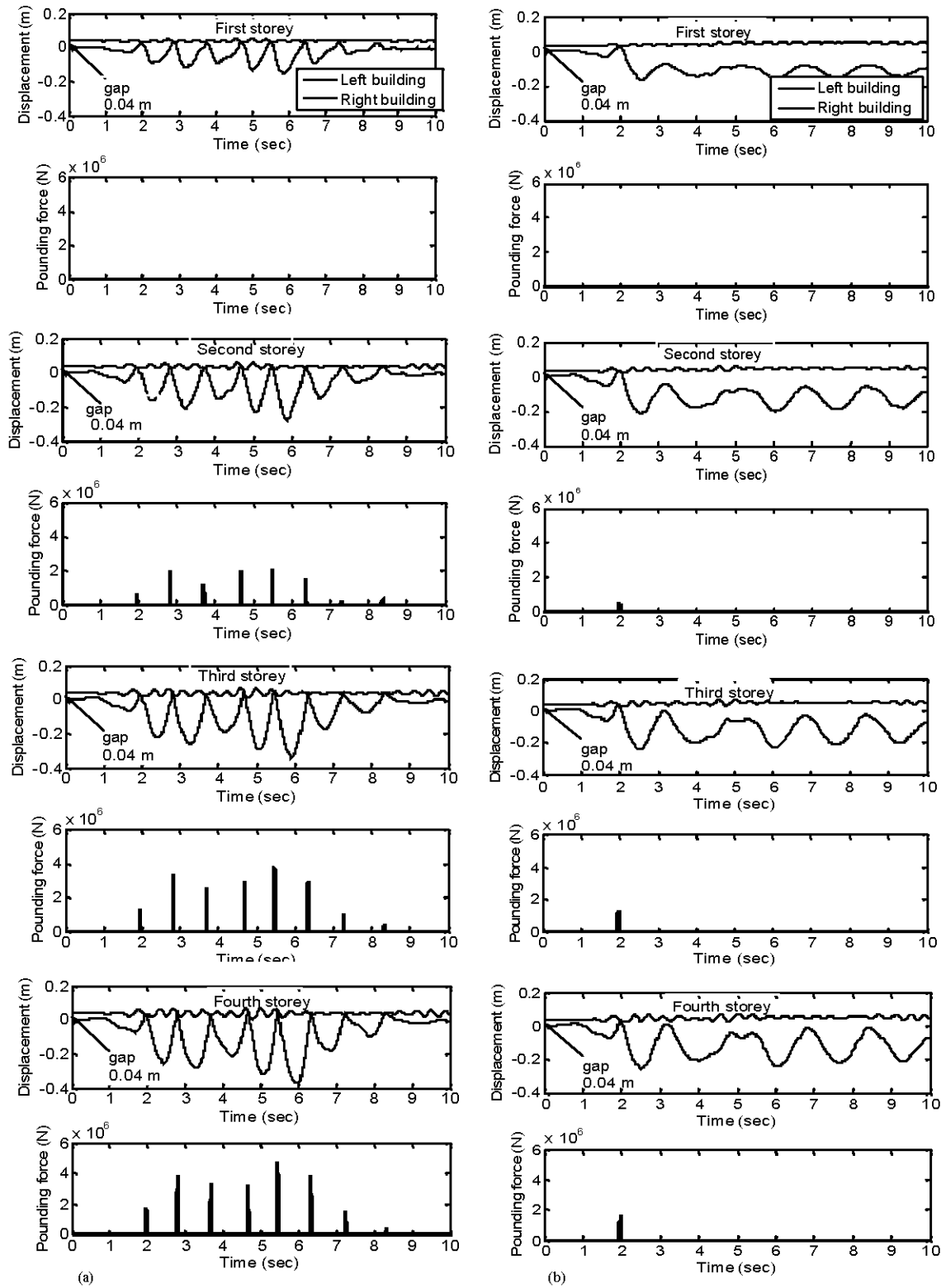

Fig. 3: Displacement and pounding force time histories under the El Centro earthquake for: (a) two buildings modelled as elastic systems; (b) two buildings modelled as inelastic systems

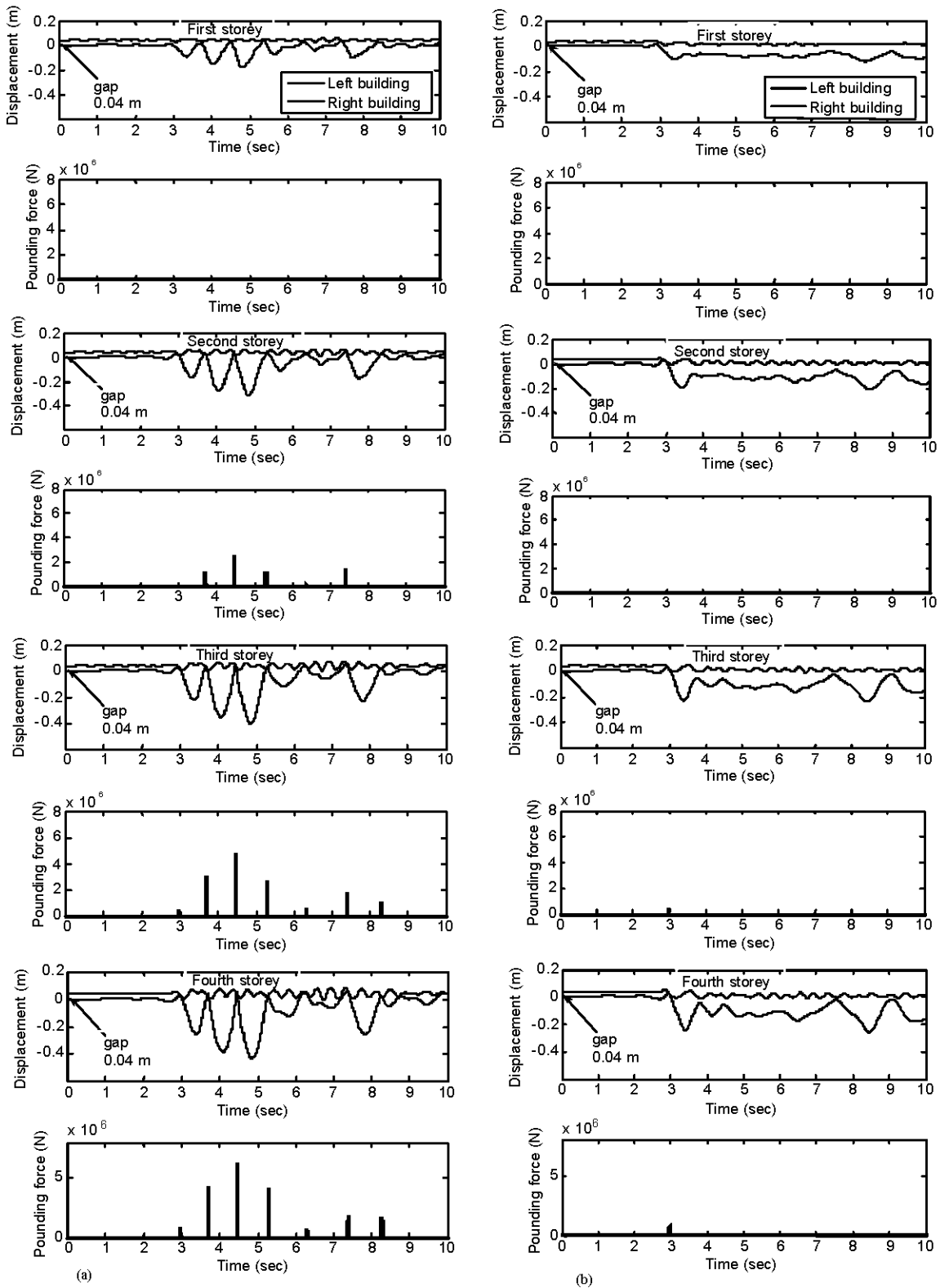

Fig. 4: Displacement and pounding force time histories under the Cape Mendocino earthquake for: (a) two buildings modelled as elastic systems; (b) two buildings modelled as inelastic systems

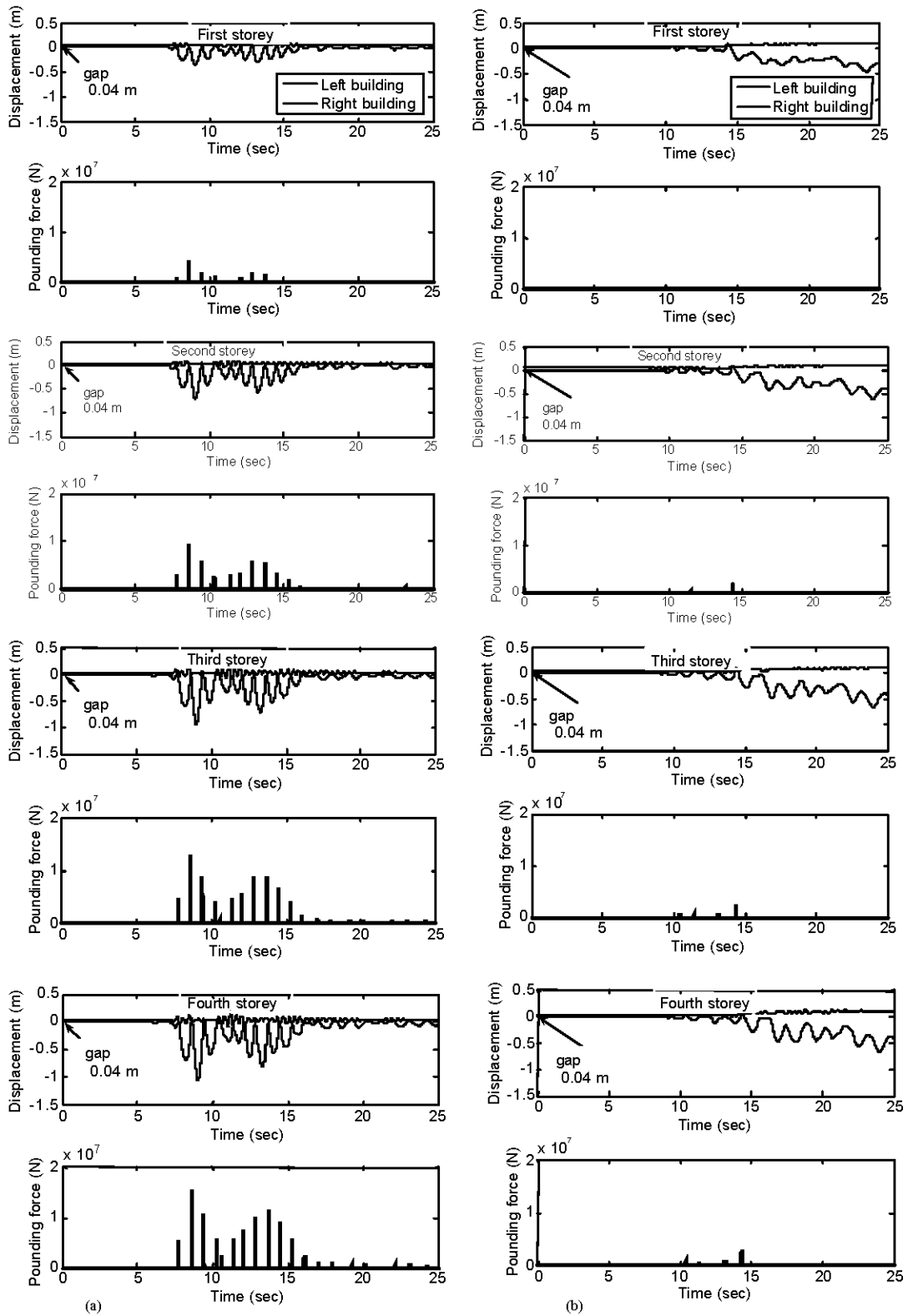

Fig. 5: Displacement and pounding force time histories under the Kobe earthquake for: (a) two buildings modelled as elastic systems; (b) two buildings modelled as inelastic systems



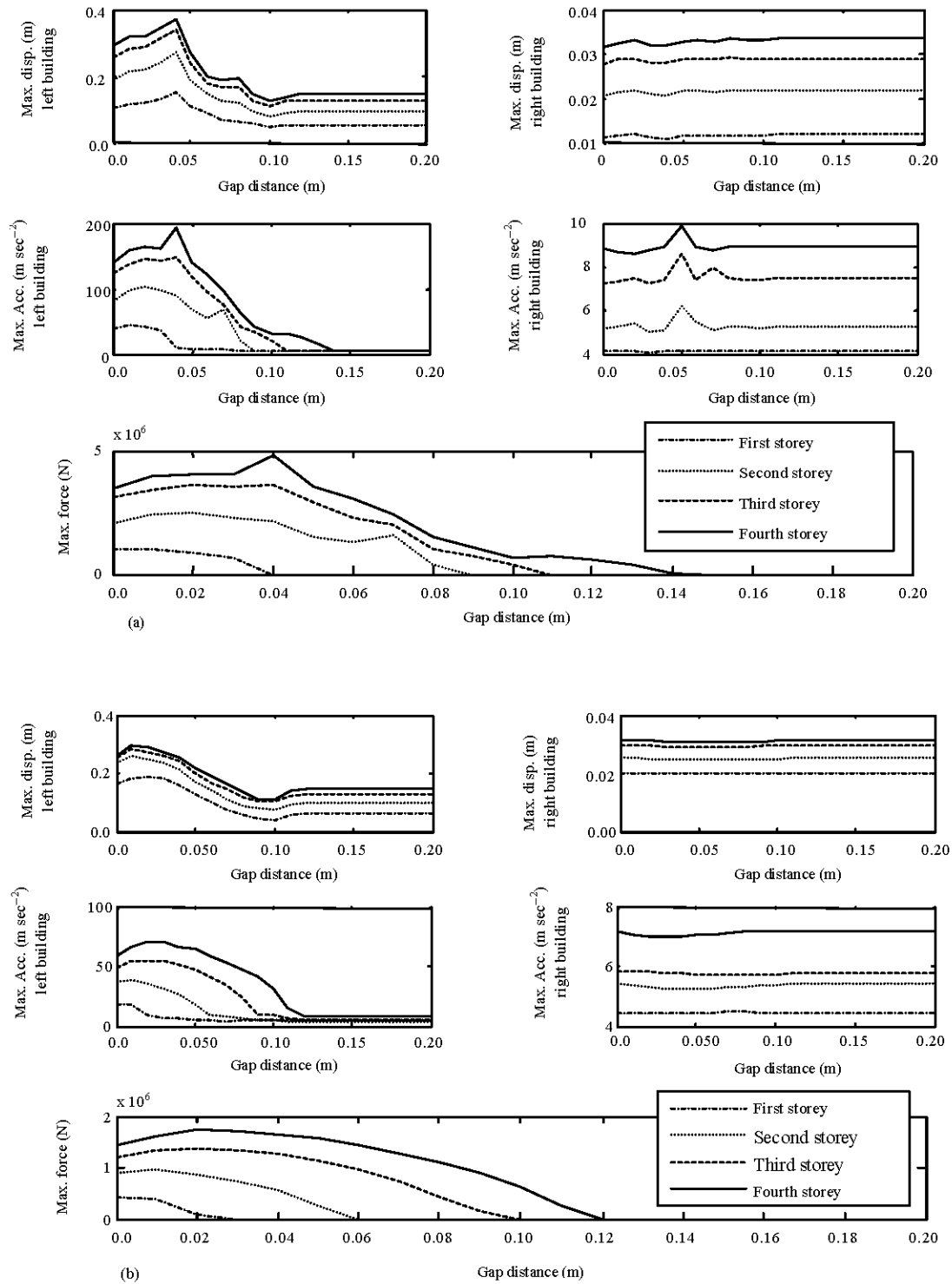

Fig. 6: Peak displacements, accelerations and pounding forces with respect to the in-between gap distance under the El Centro earthquake for: (a) two buildings modelled as elastic systems; (b) two buildings modelled as inelastic systems

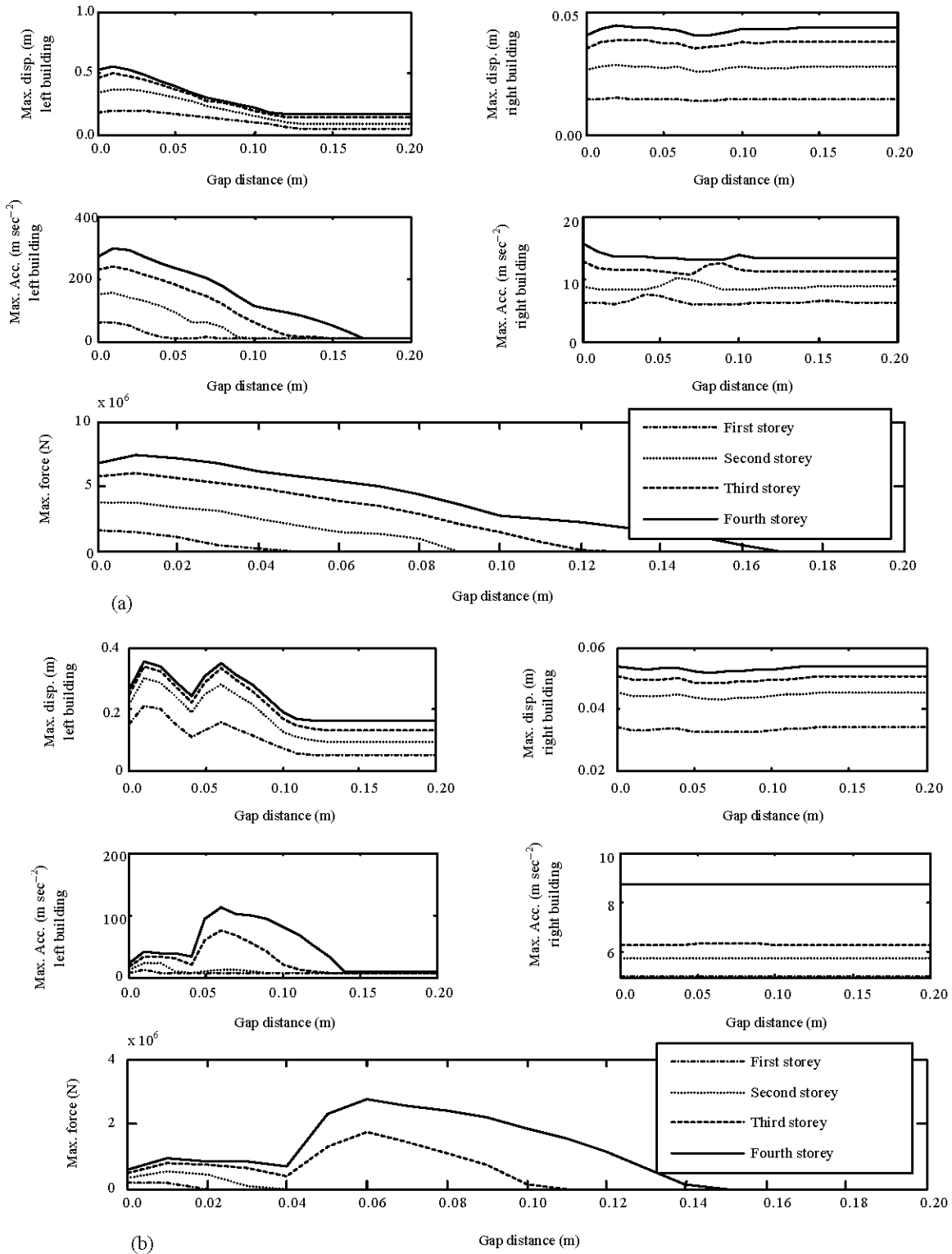

Fig. 7: Peak displacements, accelerations and pounding forces with respect to the in-between gap distance under the Cape Mendocino earthquake for: (a) two buildings modelled as elastic systems; (b) two buildings modelled as inelastic systems

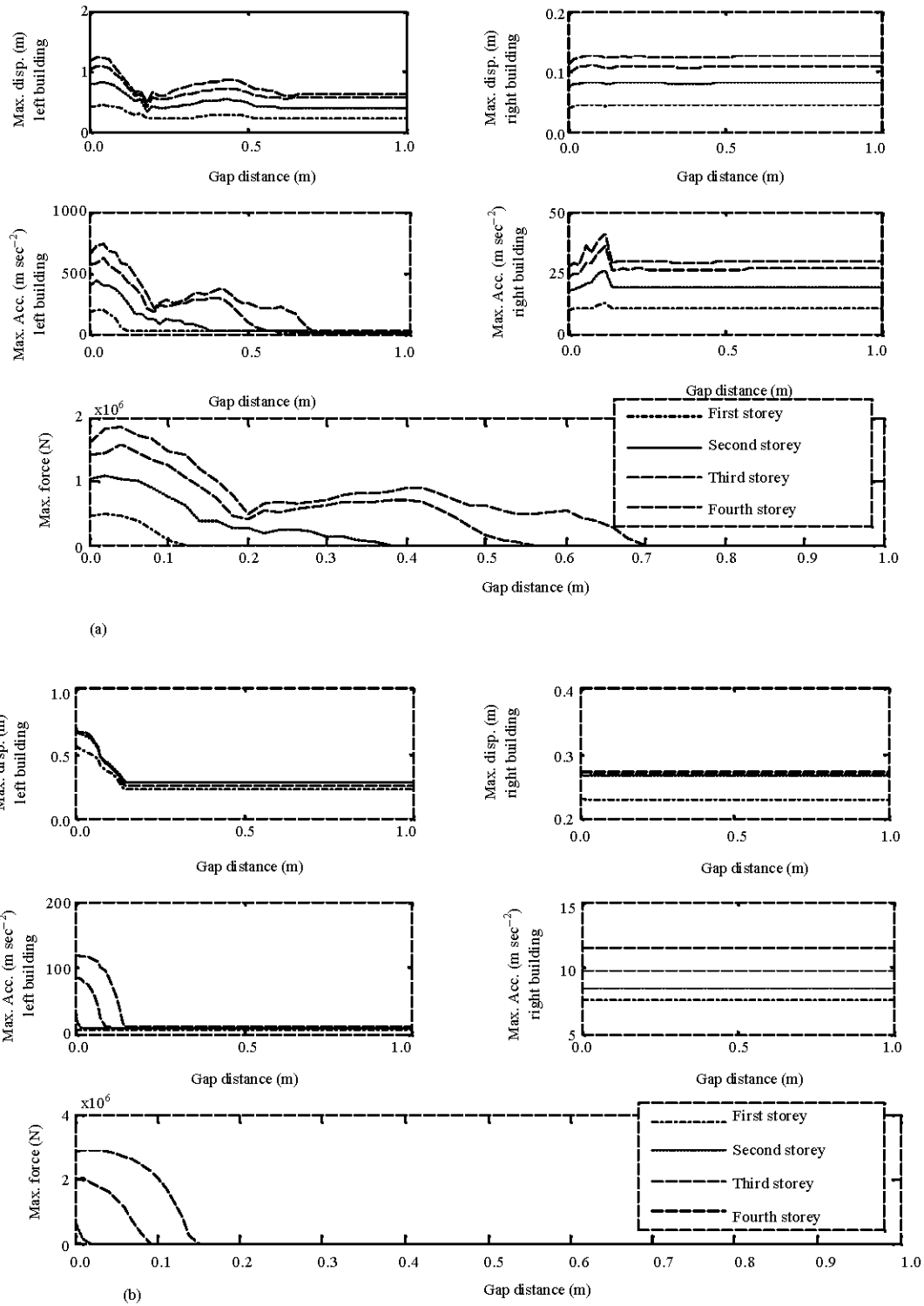

Fig. 8: Peak displacements, accelerations and pounding forces with respect to the in-between gap distance under the Kobe earthquake for: (a) two buildings modelled as elastic systems; (b) two buildings modelled as inelastic system

**Table 1: Normalized errors obtained for the El Centro, Cape Mendocino and Kobe earthquakes**

Earthquake	PGA (g)	Normalized displacement error (%)		Normalized acceleration error (%)		Normalized pounding force error (%)
		Left building	Right building	Left building	Right building	
El Centro (1940)	0.34	16.48	17.30	144.40	21.59	154.11
Cape Mendocino (1992)	0.59	38.01	33.27	266.79	58.26	292.55
Kobe (1995)	0.82	69.27	63.00	725.56	165.56	780.33

motion excitations when inelastic modelling of adjacent structures is considered in the analysis (Fig. 6a,b, 8a,b). For both elastic and inelastic systems, the peak displacements and accelerations of the storeys of the lighter and more flexible left building increase up to a certain value of the gap distance and with further increase in the gap distance a decrease trend can be observed. On the other hand, the storeys of the heavier and stiffer right building show almost identical values of peak displacements and accelerations for all considered gap distances (Fig. 6-8). Moreover, higher storeys induce higher peak responses than the lower ones for both buildings under all the ground motion records and the separation distances considered in the analysis.

The normalized errors in simulating the peak responses of the elastic systems with respect to the peak responses of the inelastic systems, calculated according to Eq. 6, are presented for the three ground motion records in Table 1. It can be seen from the Table 1 that the normalized errors are relatively high, especially for the peak accelerations and pounding forces. It is worth noting that the normalized errors increase with the increase of the levels of PGA of the earthquake records.

**CONCLUSIONS**

The comparison between the earthquake-induced pounding-involved behaviour of two adjacent buildings modelled as elastic and inelastic systems has been investigated in this paper. In the analysis, both structures have been modelled as four-storey discrete systems and the nonlinear viscoelastic model has been employed to simulate pounding force during collisions at different storey levels. Three different ground motion records with different PGA have been applied to conduct the numerical simulations. The influence of the gap distance on the structural response (peak displacement, acceleration and pounding force) has also been investigated.

The results of the study indicate that the responses of the elastic systems are significantly different comparing to the responses of the inelastic ones. This concerns especially the lighter and more flexible building, which easily enters into the yielding range as the result of

pounding. Moreover, the values of maximum impact forces and the number of impacts are larger in the elastic case.

The results of further investigation show that the peak responses are considerably reduced for all the ground motion histories when inelastic modelling of adjacent structures is considered in the analysis. For both elastic and inelastic systems, the peak displacements and accelerations of the storeys of the lighter and more flexible left building increase up to a certain value of the gap distance and with further increase in the gap distance a decrease trend is observed. On the other hand, the storeys of the heavier and stiffer right building show almost identical values of peak displacements and accelerations for all considered gap distances.

The results of this study clearly show that modelling the colliding buildings to behave inelastically is really essential in order to obtain accurate structural pounding-involved response under earthquake excitation.

IRK methods with slanting Newton iterations have been used efficiently to solve structural dynamic impact problems which are considered as system of nonsmooth ordinary differential equations (ODEs) (Chen and Mahmoud, 2008; Mahmoud and Chen, 2008; Mahmoud *et al.*, 2008). Chen and Mahmoud (2008) have analyzed the slanting Newton as an iteration method for solving the nonlinear system of equations in the IRK. The superlinear convergence of the slanting Newton method and the convergence order of IRK methods have also been proved. Moreover, the effect of step sizes on the obtained error using both Explicit Runge-Kutta (ERK) and IRK methods has shown that IRK methods are more efficient than the ERK of fourth order for solving structural dynamic impact problems (Chen and Mahmoud, 2008; Mahmoud *et al.*, 2008). In addition, a verified inexact IRK method for solving such kind of problems has been proposed to give a global error bound for the inexact solution (Mahmoud and Chen, 2008).

**ABBREVIATIONS**

- $c_i, c_j$  : Damping coefficients at storey level  $i$  and  $j$
- $\bar{c}_i$  : Impact element's damping

$C^l, C^r$  : Damping matrices for the left and the right building  
 $d$  : Gap distance  
 $e$  : Coefficient of restitution  
 $F$  : Impact force vector  
 $F_{ij}$  : Impact force between  $i$ th and  $j$ th storeys  
 $F_{yi}, F_{yj}$  : Yield strengths at storey level  $i$  and  $j$   
 $g$  : Acceleration of gravity  
 $I$  : Vector with all its elements equal to unity  
 $k_i, k_j$  : Stiffness coefficients at storey level  $i$  and  $j$   
 $K^l, K^r$  : Stiffness matrices for the left and the right building  
 $m_i, m_j$  : Masses at storey level  $i$  and  $j$   
 $M^l, M^r$  : Mass matrices for the left and the right building  
 $R_i, R_j$  : Inelastic storey restoring forces at storey level  $i$  and  $j$   
 $R^l, R^r$  : Inelastic storey restoring force vectors for the left and the right building  
 $U_i, U_j$  : Displacements at storey levels  $i$  and  $j$   
 $U^l, U^r$  : Displacement vectors for the left and the right building  
 $\dot{U}_i, \dot{U}_j$  : Velocities at storey levels  $i$  and  $j$   
 $\dot{U}^l, \dot{U}^r$  : Velocity vectors for the left and the right building  
 $\ddot{U}_i, \ddot{U}_j$  : Accelerations at storey levels  $i$  and  $j$   
 $\ddot{U}^l, \ddot{U}^r$  : Acceleration vectors for the left and the right building  
 $\ddot{U}_g$  : Earthquake acceleration  
 $\|\cdot\|$  : Euclidean norm  
 $\bar{\beta}$  : Impact stiffness parameter  
 $\delta_{ij}$  : Relative displacement  
 $\dot{\delta}_{ij}$  : Relative velocity  
 $\bar{\xi}$  : Impact damping ratio  
 ERK : Explicit Runge-Kutta  
 IRK : Implicit Runge-Kutta  
 MER : Maximum elastic response  
 MIR : Maximum inelastic response  
 NE : Normalized error  
 ODE : Ordinary differential equation  
 PGA : Peak ground acceleration  
 SDOF : Single-degree-of-freedom

## REFERENCES

Anagnostopoulos, S.A., 1988. Pounding of buildings in series during earthquakes. *Earth q. Eng. Struct. Dyn.*, 16: 443-456.  
 Athanassiadou, C.J. and G.G. Penelis, 1985. Elastic and inelastic system interaction under an earthquake motion. *Proceedings of the 7th Hellenic Conference on Concrete*, 1985, Patras, Greece, pp: 211-216.

Bertero, V.V., 1985. Observations on structural pounding. *Proceedings of the International Conference: The Mexico Earthquake, 1985*, ASCE., pp: 264-278.  
 Chau, K.T. and X.X. Wei, 2001. Pounding of structures modelled as nonlinear impacts of two oscillators. *Earthq. Eng. Struct. Dyn.*, 30: 633-651.  
 Chau, K.T., X.X. Wei, X. Guo and C.Y. Shen, 2003. Experimental and theoretical simulations of seismic poundings between two adjacent structures. *Earthq. Eng. Struct. Dyn.*, 32: 537-554.  
 Chen, X. and S. Mahmoud, 2008. Implicit Runge-Kutta methods for Lipschitz continuous ordinary differential equations. *SIAM. J. Numer. Anal.*, 46: 1266-1280.  
 Chen, X., Z. Nashed and L. Qi, 2000. Smoothing methods and semismooth methods for non-differentiable operator equations. *SIAM. J. Numer. Anal.*, 38: 1200-1216.  
 Jankowski, R., 2005. Nonlinear viscoelastic modelling of earthquake-induced structural pounding. *Earthq. Eng. Struct. Dyn.*, 34: 595-611.  
 Jankowski, R., 2006a. Pounding force response spectrum under earthquake excitation. *Eng. Struct.*, 28: 1149-1161.  
 Jankowski, R., 2006b. Analytical expression between the impact damping ratio and the coefficient of restitution in the nonlinear viscoelastic model of structural pounding. *Earthq. Eng. Struct. Dyn.*, 35: 517-524.  
 Jankowski, R., 2008. Earthquake-induced pounding between equal height buildings with substantially different dynamic properties. *Eng. Struct.*, 30: 2818-2829.  
 Lopez Garcia, D., 2004. Separation between adjacent nonlinear structures for prevention of seismic pounding. *Proceedings of the 13th World Conference on Earthquake Engineering*, 2004, Vancouver, Canada, pp: 235-235.  
 Mahmoud, S., 2008. Modified linear viscoelastic model to eliminate tension force in the linear viscoelastic. *Proceedings of the 14th World Conference on Earthquake Engineering*, 2008, Beijing, China, pp: 66-66.  
 Mahmoud, S. and X. Chen, 2008. A verified inexact Implicit Runge-Kutta method for nonsmooth ODEs. *Numer. Algorithms*, 47: 275-290.  
 Mahmoud, S., X. Chen and R. Jankowski, 2008. Structural pounding models with Hertz spring and nonlinear damper. *J. Applied Sci.*, 8: 1850-1858.

- Maison, B.F. and K. Kasai, 1992. Dynamics of pounding when two buildings collide. *Earthq. Eng. Struct. Dyn.*, 21: 771-786.
- Muthukumar, S. and R. DesRoches, 2006. A Hertz contact model with nonlinear damping for pounding simulation. *Earthq. Eng. Struct. Dyn.*, 35: 811-828.
- Pantelides, C.P. and X. Ma, 1998. Linear and nonlinear pounding of structural systems. *Comput. Struct.*, 66: 79-92.
- Penzien, J., 1997. Evaluation of building separation distance required to prevent pounding during strong earthquakes. *Earthq. Eng. Struct. Dyn.*, 26: 849-858.
- Valles, R.E. and A.M. Reinhorn, 1996. Evaluation, Prevention and mitigation of pounding effects in building structures. *Proceedings of the 11th World Conference on Earthquake Engineering, 1996, Acapulco, Mexico*, pp: 26-26.