

## ELECTROCHEMICAL SENSOR FOR MEASUREMENT OF VOLATILE ORGANIC COMPOUNDS EMPLOYING SQUARE WAVE PERTURBATION VOLTAGE

Jacek Gębicki, Adam Kloskowski

Gdansk University of Technology, Chemical Faculty, 11/12 Narutowicza, 80-233 Gdansk, Poland  
(✉ jg@chem.pg.gda.pl, +48 58 347 2752, adam.kloskowski@pg.gda.pl)

### Abstract

The paper presents the results of investigation on a prototype sensor for measurement of benzaldehyde in air. Sensitivity and limit of quantification of the sensor were determined for different internal electrolytes using square wave voltammetry (SWV) as the detection technique. The working and counter electrodes were made of platinum. Ionic liquids 1-hexyl, 3-methylimidazolium chloride, 1-hexyl, 3-methylimidazolium bis (trifluoromethanesulfonyl) imide and 1-butyl, 3-methylimidazolium tricyanomethane constituted the internal electrolyte. A polydimethylsiloxane (PDMS) membrane separated the gaseous medium from the electrolyte.

Keywords: sensor, VOCs, ionic liquid, square wave voltammetry, PDMS.

© 2010 Polish Academy of Sciences. All rights reserved

### 1. Introduction

According to the United States Environmental Protection Agency (EPA) the criteria of classification of organic compounds to a class of volatile organic compounds (VOCs) are high vapour pressure and boiling point within the range 50–250°C. The compounds, which are in gaseous state in the aforementioned conditions, glycols, phenols and aromatic compounds possessing more than 10 carbon atoms in a molecule are excluded from the class of volatile organic compounds. The most important VOCs are trimethylbenzenes, xylenes, alkylbenzenes, aldehydes, formaldehyde, ethanol, esters. Currently one of the most serious environmental hazards is emission of toxic and often also mutagenic as well as carcinogenic organic compounds. Volatile organic compounds belong to a group of the most hazardous pollutants emitted to the atmosphere. They are known as not only the precursors of photochemical oxidation, but also as the carcinogenic substances (benzene, 1,3-butadiene, styrene). Upon presence of nitrogen oxides the VOCs form ozone, which is the main component of a photochemical smog. Moreover, some VOCs contribute to the progress of the greenhouse effect (halide derivatives of hydrocarbons) and to a formation of the secondary organic aerosols (toluene, xylene, ethylbenzene) [1]. Volatile organic compounds originate from both the processes connected with anthropogenic activity as well as from the natural sources. The anthropogenic sources of the VOCs are mining and combustion of fuels, processing of crude oil, metallurgical industry, organic chemistry industry, production and use of solvents, food industry, agriculture, utilization of solid waste and transport. On a global scale the natural emission of the VOCs is of fundamental importance. Natural sources release over ten times more VOCs than the anthropogenic ones. The main source of the natural emission is vegetation. In more densely populated regions the contribution of the natural emission decreases, while the anthropogenic emission increases. In Europe the biogenic sources are responsible for only 57% of the total VOCs output [2].

According to the EU directive [3], it is required to monitor the ozone precursors. The aim is to analyze the trends of changes of the precursor's concentration in order to evaluate the effectiveness of the strategies oriented towards reduction of their emission, to supervise the consistence of emission record keeping and to classify the sources of emission. An additional goal is better understanding of the processes of ozone formation, ozone precursors transport and spreading as well as the application of photochemical models.

The regulations concerning the limit of VOCs emission have also been changed in Polish law (Dz.U. No. 11 pos. 72 of 16.01.2007). It is an evidence of increasing concern about health, work safety precautions, protection of natural environment and it stems from increasingly strict regulations on emission control in the vicinity of hazardous industrial plants.

The currently employed reference method for measurement of the VOCs is gas chromatography (GC) with a FID detector (FID – flame-ionization detector) and with preliminary enrichment on a sorbent. The measurements employing chemical (electrochemical) sensors characterized by a limit of quantification lower than 100 ppb can be a valuable source of qualitative and quantitative information concerning pollution due to the VOCs and would be complementary to the reference method. Chemical sensors can be an alternative to the expensive, sophisticated analytical apparatus. Their advantages are relatively low cost, good metrological parameters, short response time and ability of continuous operation *in situ*, eliminating the necessity of sampling and sample preparation prior to the analysis. A potential benefit could be a reduction of analysis cost as compared to the currently applied technique – GC-FID with a preliminary sorption.

In the case of electrochemically active analytes of the VOC type the limit of quantification of the discussed sensor can be lowered by application of suitable:

- membrane;
- detection technique;
- basic electrolyte constituting an environment for electrochemical reaction.

The most frequently applied membrane exhibiting high selectivity coefficients with respect to the VOCs is a composite membrane based on polydimethylsiloxane (PDMS) [4]. Membrane separation found an application in the technologies of the VOCs removal and recovery from air [5]. It has been successfully utilized since 1990s due to its efficiency, effectiveness and low cost.

Square wave voltammetry (SWV) is a detection technique characterized by very low limits of quantification reaching  $10^{-7}$ – $10^{-8}$  mol/dm<sup>3</sup> (when a mercury electrode is applied). An advantage of this technique is the ability to perform the measurements without preliminary enrichment of the analyte. The SWV belongs to the group of most sensitive analytical methods and it is utilized in analysis of inorganic ions and a large group of organic compounds. Literature [6–9] indicates the possibility of application of this technique to measurement of the VOCs. It is characterized by superior sensitivity, limit of quantification and resolution (small differences in the values of potential of measured analytes) as compared to classical polarography. In case of the classical polarography the limit of quantification is on the level of  $10^{-3}$ – $10^{-5}$  mol/dm<sup>3</sup>, resolution of the polarographic waves is ca. 200 mV, whereas the SWV method offers the resolution of 45 mV [10]. Improvement of these parameters was possible via elimination of capacity current.

During the last decade of the twentieth century ionic liquids were successfully utilized in organic synthesis, catalytic reactions, electrochemistry and separation techniques [11]. The ionic liquids constitute a group of chemical compounds belonging to solvents characterized by melting points below 100°C. At room temperature a number of these compounds are liquids. The ionic liquids are well-suited for the electrochemical sensors due to their advantageous properties such as low vapor pressure, high enrichment factor with respect to



the VOCs, good wetting of metal surface, wide electrochemical window and catalytic properties. That is why they have already found application in CO<sub>2</sub>, NH<sub>3</sub>, NO<sub>2</sub> and Cl<sub>2</sub> sensors [12–13].

Semiconductor sensors can be also used for measurement of the VOCs. Gas sensors of this type are made from metal oxides [14–16], most commonly tin dioxide exhibiting semiconductor properties. Their operation relies on establishment of adsorption equilibrium between the molecules of the measured gas and the grains of semiconductor resulting in a change of electrical conductivity of the sensor's material. In recent years literature has been reporting about application of nanotubes [17–18] to the modification of working electrode's surface of the sensors for measurement of gaseous atmospheric pollutants.

Bearing the aforementioned fundamentals in mind the authors of this paper attempted to build a prototype of electrochemical sensor for measurement of selected compounds from the VOCs group. The sensor was based on ionic liquid as the electrolyte and a PDMS membrane separating the gaseous environment from the electrolytic cell.

## 2. Ionic liquids

During recent years ionic liquids earned the name of environmentally friendly compounds due to their unique physicochemical properties, non-flammability and ease of recycling. They constitute an alternative for conventional, volatile and often highly toxic organic solvents. Apart from low vapor pressure an unquestionable advantage of the ionic liquids is the possibility of tailoring their properties (polarity, viscosity, density, water solubility or melting point) to a particular chemical reaction or technological process by selection of a suitable cation or anion. It is estimated that the possible number of the cation-anion combinations can reach 10<sup>18</sup>, whereas at the moment there are about 300 compounds of that type commercially available. The first ionic liquids appeared on market in 1999. In a molecule of the ionic liquid the cation is big, non-symmetrical and has exclusively organic character. The anion is smaller than the cation and more often it is inorganic rather than organic in character. Table 1 gathers the cations and anions most frequently encountered in the ionic liquids.

Properties of the ionic liquids depend on the size and type of anion as well as on the type of cation (degree of its asymmetry, length of the alkyl chain responsible for charge delocalization). The cation of a ionic liquid is responsible mainly for physical properties of the salt, whereas the anion determines the chemical properties and reactivity of the compound. The melting point of the ionic liquids is influenced by both anion and cation. A change of the anion type from an inorganic into an organic one, or an increase in the size of the anion result in lowering of the melting point down to room temperature or even lower. Low melting points are exhibited by the salts which possess a big and non-symmetrical cation. Moreover, a change of the alkyl chain length determines the type of transitions occurring at the point of liquidity loss of the ionic liquid, for example it influences the disturbance of the crystallization process leading to glass transition or to polymorphism.

Viscosity of the ionic liquids is diversified and it falls within the range 10–1000 cP. An increase in the length of alkyl substituent contributes to an increase in viscosity. The presence of traces of impurities may lead to rapid changes of viscosity. Due to asymmetric structure as well as various tendency to form hydrogen bonds and ionic couples, the conductivity of the ionic liquids is not a simple function of their viscosity. In the case of imidazolium ionic liquids electrical conductivity is from 0,005 to even 100 mScm<sup>-1</sup> for 1-ethyl, 3-methylimidazolium fluoride [19] (for 1M solution of KCl electrical conductivity at 25°C it is 112mScm<sup>-1</sup>). The ionic liquids are characterized by higher density than water. Elongation of alkyl substituent is accompanied by a decrease in density. Density of the ionic liquids



increases with an increase in size of the anion. Selection of the anion also influences the solubility of the ionic liquids in water.

Table 1. The most popular ionic liquids.

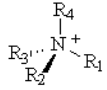
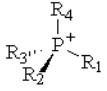
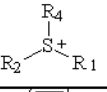
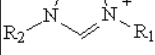
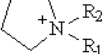
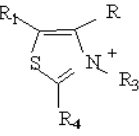
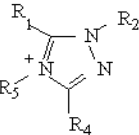
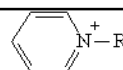
cation	structure	anion	structure
alkylammonium		halide	$X^-: F^-, Cl^-, Br^-, I^-$
alkylphosphonium		tetrafluoroborate	$BF_4^-$
alkylsulphonium		hexafluorophosphate	$PF_6^-$
alkylimidazolium		trifluoroacetate	$CF_3COO^-$
alkylpyrrolidinium		hexafluoroantimonate	$SbF_6^-$
alkylthiazolium		trifluorosulphoacetate	$CF_3SO_3^-$
alkyltriazolium		bis(trifluoromethylsulfonyl)imide	$(CF_3SO_2)_2N^-$
alkylpyridinium		tricyanomethyl	$(CN)_3C^-$

The ionic liquids utilized by the authors as the environment for an electrochemical reaction in the sensor prototype are presented in Table 2. They exhibited different physical properties, the selection of which was aimed at determination of the impact of viscosity, conductivity or water solubility on the sensor performance with a given internal electrolyte.

Table 2. Properties of the ionic liquids utilized in the investigation on a prototype sensor for measurement of VOCs, determined at 20°C [19].

Ionic liquid	Melting point [°C]	Electrical conductivity [mS $cm^{-1}$ ]	Viscosity [cP]	Density [kg/m $^3$ ]	Solubility in water
1-hexyl, 3-methylimidazolium chloride	-85	0,8	716	1030	yes
1-hexyl, 3-methylimidazolium bis (trifluoromethanesulfonyl) imide	-7	2,6	78	1370	no
1-butyl, 3-methylimidazolium tricyanomethan	> -50	18,0	34	1050	yes

### 3. Square wave voltammetry

In this method a square wave voltage signal is superimposed on a linearly or step-wise changing potential of a working electrode. Faradic ac current due to the square wave potential changes is registered versus the dc component of the working electrode potential. The current



is registered at the end of each pulse as well as just before each next pulse and it is the resultant of the positive and negative pulse currents. Fig. 1 illustrates the superposition of the square wave on the step-wise changing potential where  $\psi$  is the period of the square wave,  $\tau$  is the pulse duration (half-period),  $t_m$  is the measurement time,  $E_{SW}$  denotes the amplitude of the square wave and  $E_{DC}$  is the change of the dc component. The frequency of the square wave is usually 200-250 Hz, the amplitude is between 5 and 50 mV and the potential step is ca. 10 mV.

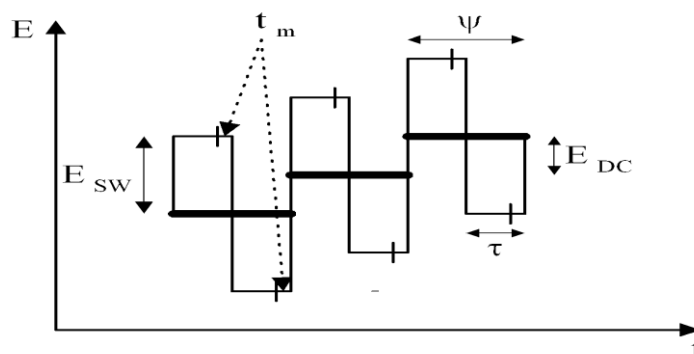

Fig. 1. Change of potential of the working electrode during square wave voltammetry.

The superimposition of the square wave voltage over the *dc* potential changing in time resulted in practical elimination of the capacity current ( $I_C$ ). This current  $I_C$  decays very rapidly after a change of the electrode potential by  $E_{SW}$  value following the Eq. (1):

$$I_C = \frac{E_{SW}}{R} \exp\left(\frac{-t}{RC}\right), \quad (1)$$

where  $R$  and  $C$  stand for the resistance and capacitance reaction site is the slowest stage) can be described by the following dependence (2): of the electrolytic system, respectively,  $t$  denotes the time since the last change of potential by  $E_{SW}$  value. On the other hand the faradic current decays much slower versus time and is approximately proportional to  $t^{-0.5}$ . If a measurement is performed at the end of the pulse duration, it is the faradic current that is measured in practice as the capacity current approaches zero at that time instant. Elimination of the capacity current makes it possible to apply this method for quantitative measurements of the substances, the concentration of which is of the order of  $10^{-8}$  mol/dm<sup>3</sup> [20]. The faradic current, or rather a result of this current, for a reversible electrode process (the electrode process, in which analyte diffusion towards the

$$\Delta I_F = \frac{n^2 F^2 E_{SW} D^{0.5} A C^b \theta H}{RT \pi^{0.5} \tau^{0.5} (1 + \theta)^2}, \quad (2)$$

where  $n$  is the number of electrons participating in a reaction,  $F$  is the Faraday constant,  $D$  is the diffusion coefficient of a species undergoing an electrochemical reaction,  $A$  is the active surface area of the working electrode,  $C^b$  is the analyte concentration in an electrochemical cell,  $R$  is the gas constant,  $T$  is temperature,  $\tau$  is the time of pulse duration,  $\theta$  and  $H$  are the parameters described by the Eqs (3) and (4).

$$\theta = \exp\left(\frac{(E - E_{1/2})nF}{RT}\right), \quad (3)$$

where  $E$  is the current potential of the working electrode,  $E_{1/2}$  is the half-wave potential characteristic for a given analyte.

$$H = \sum_{m=0}^{\infty} (-1)^m \frac{1}{\left(m + \frac{t_m}{\tau}\right)^{0.5}}, \quad (4)$$

where  $H$  is the dimensionless quantity being constant for a given piece of instrument. In the case of an irreversible process, where charge transfer between the analyte and electrode is the slowest stage of the electrode process, the resultant faradic current is given by the dependence (5):

$$\Delta I_F = \frac{n^2 F^2}{RT} A E_{sw} k C^b \sum_{m=0}^{\infty} (-1)^m \exp N^2 \left(m + \frac{t_m}{\tau}\right) \operatorname{erfc} N \left(m + \frac{t_m}{\tau}\right)^{0.5}, \quad (5)$$

where  $k$  is the electrode reaction rate constant,  $\operatorname{erfc}$  is the error function complement,  $N$  is the parameter described by Eq. (6):

$$N = k \left(\frac{\tau}{D}\right)^{0.5}. \quad (6)$$

The dependences presented above show that irrespective of the character of the electrode process (reversible, irreversible) the resultant faradic current obtained is dependent on ac voltage amplitude, the pulse duration and dc component potential, keeping the remaining quantities (including analyte concentration) constant. The analyte concentration present in the Eqs (2) and (5) denotes the concentration in the electrochemical cell, which depends on the analyte concentration outside the sensor. The concentration of the analyte in the sensor's cell is influenced by analyte solubility in PDMS membrane, analyte solubility in an internal electrolyte (ionic liquid) of the sensor and by PDMS membrane thickness. For a given sensor, given ionic liquid and given analyte concentration, a cylindrical casing of diameter 2 cm and height 4 cm constituted the measurement cell. The second part was a container with a saturated KCl solution, with the reference electrode immersed in it. The measurement cell was filled with ca. 2 cm<sup>3</sup> of the ionic liquid (p.f.a., Merck). Inside the cell there was a working electrode in the form of a wire (length 0,5 cm, diameter 2 mm) and the auxiliary electrode (counter electrode) in the form of a plate, the surface area of which was 30 times bigger than the surface area of the working electrode. A polypropylene U-tube filled with KCl-agar was an electrolytic bridge between the measurement cell and the container with saturated KCl solution. In the bottom part of the cell there was a polydimethylsiloxane membrane of 100 μm thickness separating the gaseous medium from the ionic liquid. The cylindrical casing of the sensor was made of polyetheretherketone (PEEK). Three sensors were built with a PDMS membrane of thickness 100. In both sets of three sensors each one contained a different internal electrolyte. The internal electrolytes were: 1-hexyl, 3-methylimidazolium chloride, 1-hexyl, 3-methylimidazolium bis(trifluoro-methanesulfonyl)imide, 1-butyl, 3-methylimidazolium tricyanomethan; all the electrolytes were p.f.a. grades.





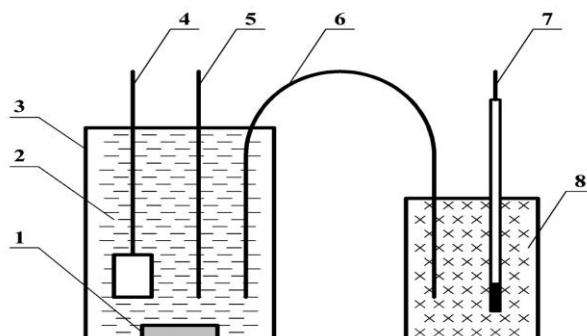

Fig. 2. A prototype of the VOC sensor: 1 – polydimethylsiloxane membrane, 2 – internal electrolyte (ionic liquid), 3 – casing, 4 – counter electrode, 5 – working electrode, 6 – electrolytic bridge, 7 – reference electrode, 8 – container with KCl.

#### 4.2. Reference mixtures

The reference mixtures were prepared using the static method. A glass vessel of 2 dm<sup>3</sup> volume was evacuated to the pressure of 40 mmHg using a vacuum pump. Then a suitable volume of the reference liquid was introduced into the vessel using a microsyringe, where it evaporated rapidly. After the pressure has been equilibrated by an injection of synthetic air, the mixture was kept at constant temperature for 24 hours in order to equalize the concentrations. The vessels were conditioned between the measurements by keeping them under vacuum for 12 hours at the boiling temperature of the respective compound. The accuracy of determination of the reference mixture concentration was controlled using the gas chromatography technique. Dispersion of the results was within  $\pm 5\%$ .

#### 4.3. Measurement set-up

The measurement set-up consisted of the following elements: a generator of gaseous reference mixtures, a prototype sensor, a PAR 263A potentiostat and a PC with controlling software (Fig. 3). Cyclic voltamograms were registered in dry synthetic air and in the reference mixture air/benzaldehyde containing 100 ppm v/v of benzaldehyde. In each case the potential scan rate was 100 mV/s. The parameters of the square wave perturbation voltage were selected and optimized via the simplex method. Following this optimization the most advantageous sensor response was obtained when the square wave amplitude was 50 mV, its frequency was equal to 10 Hz and the DC potential step was 5mV. The calibration curves of the sensor ( $I = f(c)$ ) were determined for precisely defined concentrations of gaseous mixtures. The sensor was subjected to conditioning for a few hours prior to the electrochemical investigations in order to obtain stable, constant in time measurement parameters ensuring reliability and reproducibility of the results.

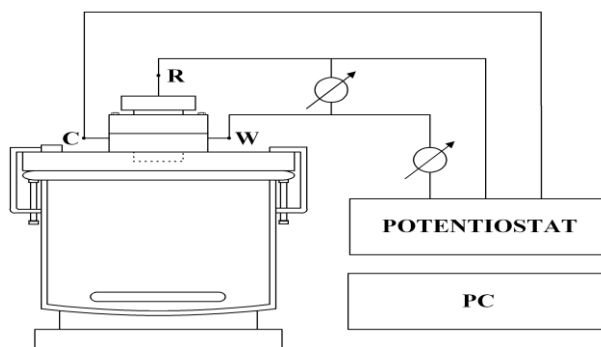

Fig. 3. Scheme of the set-up for measurement of the VOCs in static conditions.

#### 4.4. Optimization of perturbation signal via simplex method

The literature-suggested [20–21] square wave voltage is characterized by an amplitude within the range 5–50 mV and a frequency of pulse change between 200 and 250 Hz. These values usually concern aqueous solutions of strong acids, bases and salts serving as the basic electrolyte. In the case of ionic liquids exhibiting lower conductivity the aforementioned parameters may be not sufficient to minimize the capacity current due to charging and discharging of the electrical double layer. Accordingly, the application of a relatively simple and effective simplex method of optimization made it possible to define the most advantageous parameters of the ac voltage. It was arbitrarily set that for all attempts the potential step would be 5 mV and that only the ac voltage parameters would be optimized. At the beginning of the experiment, after registration of the voltamograms in a mixture containing 100 ppm v/v of benzaldehyde, a localization of the anodic peak for 1-hexyl, 3-methylimidazolium chloride was found. Then the voltamograms were registered using square wave voltammetry with different parameters, but only within the potential range where the anodic peak had been found. In the next step the value of the peak was determined on the SWV voltamograms and assigned to the respective parameters of the square wave voltage. In this way three starting points were determined: A ( $E_{SW} = 20$  mV,  $\tau = 20$  ms,  $\Delta I = 2,2$   $\mu$ A), B ( $E_{SW} = 20$  mV,  $\tau = 40$  ms,  $\Delta I = 3,1$   $\mu$ A) C ( $E_{SW} = 40$  mV,  $\tau = 20$  ms,  $\Delta I = 3,9$   $\mu$ A). Fig. 4 presents the successive steps aimed at finding the point characterized by the most advantageous  $\Delta I$  value. Arranging the points A, B, C with respect to increasing  $\Delta I$  value, a reflection of the point A in the barycentre of the remaining simplex points was done. In this way the point D was obtained, which was characterized by the following parameters:  $E_{SW} = 40$  mV,  $\tau = 40$  ms and  $\Delta I = 4,6$   $\mu$ A. As point D revealed a better  $\Delta I$  value than the points B and C there was an expansion of the point D to the point E. The point E corresponded to the following parameters:  $E_{SW} = 50$  mV,  $\tau = 50$  ms and  $\Delta I = 6,7$   $\mu$ A. The next expansion from the point E to point F yielded the following values:  $E_{SW} = 60$  mV,  $\tau = 60$  ms, and  $\Delta I = 5,5$   $\mu$ A. The point F possessed worse  $\Delta I$  than the point E. A reflection of the point C with respect to the barycentre of the points B and E gave the point G having  $E_{SW} = 30$  mV,  $\tau = 70$  ms,  $\Delta I = 3,5$   $\mu$ A. This point also revealed a worse  $\Delta I$  value than point E. A reflection of the point B with respect to the barycentre of the points C and E yielded the point H characterized by the parameters  $E_{SW} = 70$  mV,  $\tau = 30$  ms,  $\Delta I = 4,0$   $\mu$ A. This point had a worse  $\Delta I$  value than point E. At this stage the optimization of the parameters of the square wave was terminated and the most advantageous  $\Delta I$  value was found for the amplitude of 50 mV and pulse duration 50 ms. These parameters were also applied for the remaining two ionic liquids in order to compare the parameters of the sensor such as sensitivity and limit of quantification.

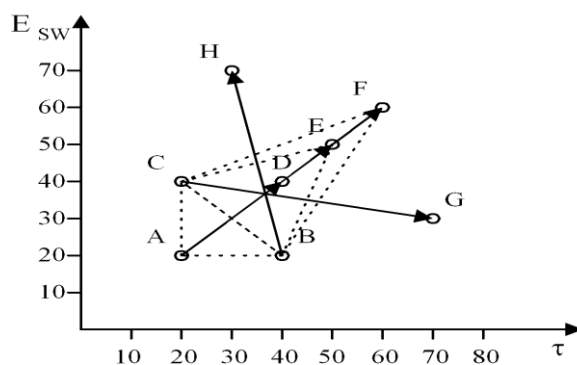

Fig. 4. Illustration of steps in the simplex method searching for a peak characterized by the most advantageous current value resulting from square wave voltage perturbation.



## 5. Results and discussion

Fig. 5 presents the cyclic voltamograms registered in synthetic dry air and in a mixture of dry air/benzaldehyde for the sensor containing 1-hexyl, 3-methylimidazolium chloride as the internal electrolyte. The range of electrochemical stability of the ionic liquid constituting the basic electrolyte is from  $-1,5$  V to  $0,7$  V. It is limited by the oxidation of chloride ions in the anodic potential region and by a reduction of imidazolium cation in the cathodic potential region. A cathodic peak at the potential  $-1,4$  V and an anodic peak at the potential  $-0,77$  V can be observed in the obtained cyclic voltamograms and they correspond to a reduction of benzaldehyde and an oxidation of benzaldehyde, respectively. The cathodic peaks at the potentials  $0,1$  V and  $0,7$  V are most probably due to a reduction of chlorine liberated during anodic polarization. The values of cathodic peak current ( $i_K$ ) and anodic peak current ( $i_A$ ) are the following:  $i_K = -14$   $\mu$ A and  $i_A = 7,7$   $\mu$ A. Fig. 6 shows the SWV voltamograms registered in the potential range from  $-0,95$  V to  $-0,5$  V for the gaseous mixtures dry air/benzaldehyde containing 10 ppm v/v, 25 ppm v/v, 50 ppm v/v, 75 ppm v/v 100 ppm v/v of benzaldehyde. It can be noticed that an increase in benzaldehyde concentration in the mixture is accompanied by an increase in the sensor signal, which reaches the maximum of ca. 7  $\mu$ A for the concentration 100 ppm v/v. The calibration curve depicted in Fig. 6 (right side), illustrating the value of the anodic peak versus benzaldehyde concentration in air, makes it possible to determine the sensor sensitivity and limit of quantification.

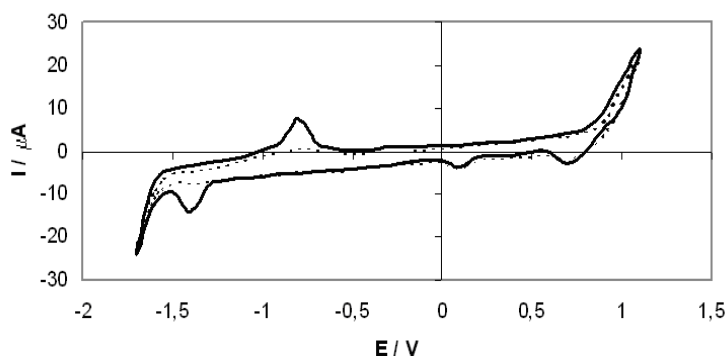

Fig. 5. Comparison of the cyclic voltamograms obtained for the sensor exposed to the mixture dry air/benzaldehyde containing 100 ppm v/v of benzaldehyde (solid line) and to dry air (dashed line). Internal electrolyte 1-hexyl, 3-methylimidazolium chloride.

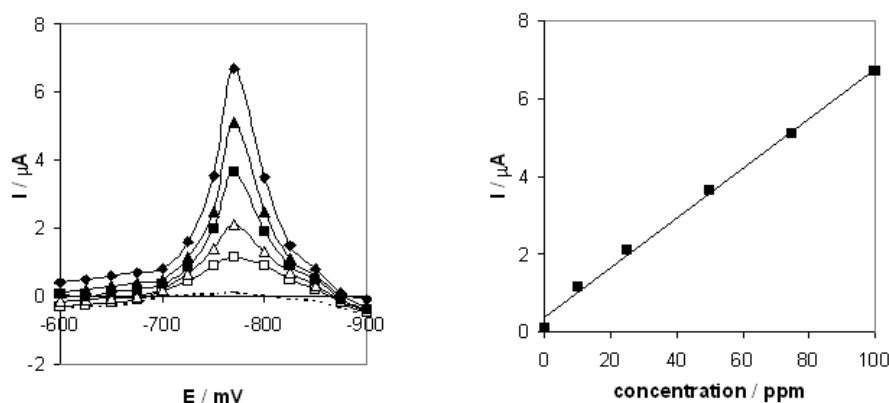

Fig. 6. SWV voltamograms obtained for the sensor exposed to the gaseous mixtures dry air/benzaldehyde. Internal electrolyte 1-hexyl, 3-methylimidazolium chloride. Dry air-dashed line. ( $\square$ ) – 10 ppm v/v, ( $\triangle$ ) – 25 ppm v/v, ( $\blacksquare$ ) – 50 ppm v/v ( $\blacktriangle$ ) – 75 ppm v/v, ( $\blacklozenge$ ) – 100 ppm v/v of benzaldehyde. Right plot – calibration curve of the sensor for measurement of benzaldehyde in air, obtained based on the SWV voltamograms.

Working electrode potential  $E = -770$  mV.



Sensor sensitivity is defined as the slope of the calibration curve and the value of the limit of quantification ( $LOQ = 3 LOD$ , where  $LOD$  is the limit of detection) was assessed using the dependence described by the formula (7):

$$LOD = \frac{3,3s_{xy}}{b}, \quad (7)$$

where  $s_{xy}$  is the residual standard deviation of the calibration curve,  $b$  is the slope of the calibration curve (sensor sensitivity). The residual standard deviation is calculated from Eq. (8):

$$s_{xy} = \sqrt{\frac{\sum (y_i - Y_i)^2}{n - 2}}, \quad (8)$$

where  $y_i$  is the value determined experimentally,  $Y_i$  is the value calculated using the regression equation,  $n$  is the number of independent measurements for the reference concentrations, which were the basis of the calibration curve construction. The evaluated sensor parameters (sensitivity and limit of quantification) for a particular ionic liquid are gathered in Table 3.

Fig. 7 shows the cyclic voltamograms registered in synthetic dry air and in a mixture dry air/benzaldehyde for the sensor containing 1-hexyl, 3-methylimidazolium bis(trifluoromethanesulfonyl)imide as the internal electrolyte. The range of electrochemical stability of the ionic liquid constituting the basic electrolyte is from  $-1,2$  V to  $0,8$  V. A cathodic peak at the potential of  $-1,1$  V and an anodic peak at the potential of  $-0,5$  V can be observed in the obtained cyclic voltamograms and they correspond to a reduction of benzaldehyde and an oxidation of benzaldehyde, respectively. The values of cathodic peak current ( $i_K$ ) and anodic peak current ( $i_A$ ) are the following:  $i_K = -13 \mu\text{A}$  and  $i_A = 22 \mu\text{A}$ .

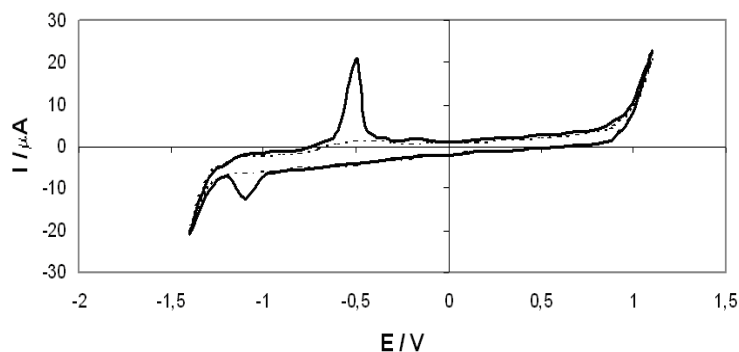

Fig. 7. Comparison of the cyclic voltamograms obtained for the sensor exposed to the mixture dry air/benzaldehyde containing 100 ppm v/v of benzaldehyde (solid line) and to dry air (dashed line). Internal electrolyte 1-hexyl, 3-methylimidazolium bis (trifluoromethanesulfonyl) imide.

Fig. 8 depicts the SWV voltamograms registered in the potential range from  $-0,75$  V to  $-0,25$  V for the gaseous mixtures dry air/benzaldehyde containing 10 ppm v/v, 25 ppm v/v, 50 ppm v/v, 75 ppm v/v, 100 ppm v/v of benzaldehyde. A sensor signal of ca.  $20 \mu\text{A}$  was found for the benzaldehyde concentration 100 ppm v/v.

Fig. 9 presents the cyclic voltamograms registered in synthetic dry air and in a mixture dry air/benzaldehyde for the sensor containing 1-butyl, 3-methylimidazolium tricyanomethane as the internal electrolyte. The range of electrochemical stability of this ionic liquid constituting the basic electrolyte is from  $-1,0$  V to  $0,5$  V. A cathodic peak at the potential  $-0,9$  V and an anodic peak at the potential  $0,05$  V can be observed in the obtained cyclic voltamograms and they correspond to a reduction of benzaldehyde and an oxidation of benzaldehyde,

respectively. An anodic peak at the potential 0,4 V is most probably associated with oxidation of cyanide groups. The values of cathodic peak current ( $i_K$ ) and anodic peak current ( $i_A$ ) are the following:  $i_K = -7 \mu\text{A}$  and  $i_A = 6 \mu\text{A}$ .

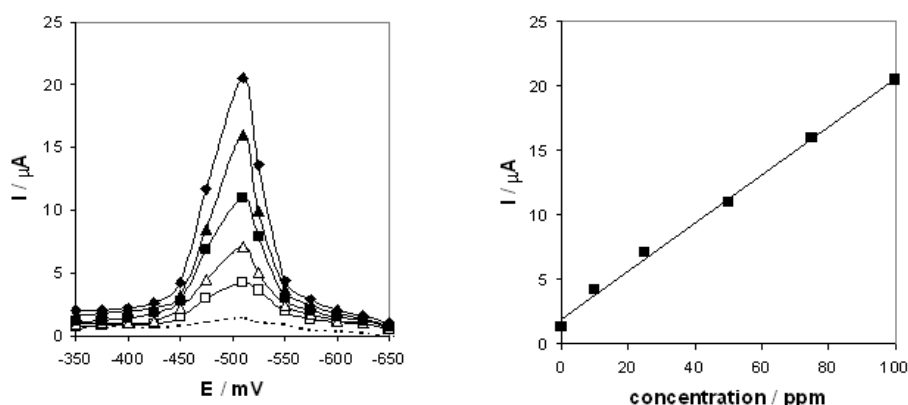

Fig. 8. SWV voltamograms obtained for the sensor exposed to the gaseous mixtures dry air/benzaldehyde. Internal electrolyte 1-hexyl, 3-methylimidazolium bis (trifluoromethanesulfonyl) imide. Dry air-dashed line. (□)10 ppm v/v, (△) – 25 ppm v/v, (■) –50 ppm v/v (▲) –75 ppm v/v, (◆) –100 ppm v/v of benzaldehyde. Right plot - calibration curve of the sensor for measurement of benzaldehyde in air, obtained based on the SWV voltamograms. Working electrode potential  $E = -500 \text{ mV}$ .

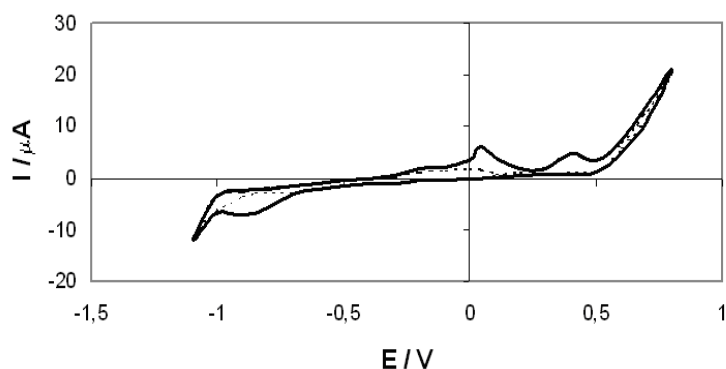

Fig. 9. Comparison of the cyclic voltamograms obtained for the sensor exposed to the mixture dry air/benzaldehyde containing 100 ppm v/v of benzaldehyde (solid line) and to dry air (dashed line). Internal electrolyte 1-butyl, 3-methylimidazolium tricyanomethan.

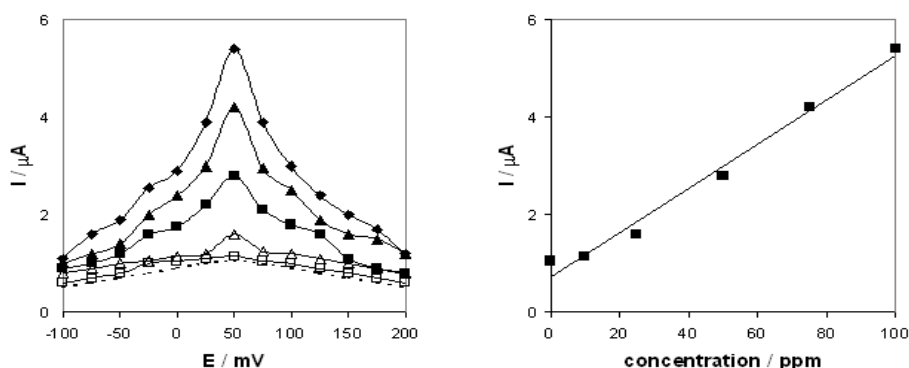

Fig. 10. SWV voltamograms obtained for the sensor exposed to the gaseous mixtures dry air/benzaldehyde. Internal electrolyte 1-butyl, 3-methylimidazolium tricyanomethan. Dry air-dashed line. (□) –10 ppm v/v, (△) – 25 ppm v/v, (■) –50 ppm v/v (▲) –75 ppm v/v, (◆) –100 ppm v/v of benzaldehyde. Right plot – calibration curve of the sensor for measurement of benzaldehyde in air, obtained based in the SWV voltamograms. Working electrode potential  $E = 50 \text{ mV}$ .

The SWV voltamograms registered in the potential range from  $-0,1$  V to  $0,2$  V for the gaseous mixtures dry air/benzaldehyde containing 10 ppm v/v, 25 ppm v/v, 50 ppm v/v, 75 ppm v/v 100 ppm v/v of benzaldehyde are presented in Fig. 10. A sensor signal of ca.  $5 \mu\text{A}$  was recorded for the benzaldehyde concentration 100 ppm v/v.

Obtained SWV voltamograms and calibration curves were used to determine the parameters of the sensor (with a  $100 \mu\text{m}$  PDMS membrane) with respect to benzaldehyde depending on the type of the internal electrolyte. These parameters are shown in Table 3. It can be concluded that within the investigated region the most advantageous parameters are exhibited by the sensor containing 1-hexyl, 3-methylimidazolium bis(trifluoromethanesulfonyl)imide as the internal electrolyte.

Table 3. Metrological parameters of the sensor for measurement of benzaldehyde acquired via the SWV technique.

Ionic liquid	1-hexyl, 3-methylimidazolium chloride	1-hexyl, 3-methylimidazolium bis (trifluoromethanesulfonyl) imide	1-butyl, 3-methylimidazolium tricyanomethan
Sensitivity [nA/ppm]	64	186	45
Limit of quantification [ppm]	28	25	53

## 6. Summary

The presented prototype of the sensor for measurement of benzaldehyde in air was characterized by a sensitivity from 45 to 186 nA/ppm, whereas the limit of quantification of the analyte was on the level of 25-53 ppm. These parameters depended on the internal electrolyte applied. The best parameters were exhibited by the sensor containing 1-hexyl, 3-methylimidazolium bis(trifluoromethanesulfonyl)imide as the internal electrolyte. The investigation revealed the possibility of application of PDMS membranes and ionic liquids in the electrochemical sensors for measurement of volatile organic compounds. The prototype of the sensor operated in a reproducible way for 3 months with a relative standard deviation of ca. 5%. The levels of detection of the prototype version of the sensor have not managed to attain the limit of quantification below 1 ppm. Nevertheless, the results of investigation suggest that after optimization of the sensor parameters such as the thickness of the PDMS membrane, type of ionic liquid, geometry of sensor, surface area of working electrode, the limit of quantification of ppb order is achievable.

## References

- [1] Cocker, D.R., Mader, B.T., Kalberer, M., Flagan, R.C., Seinfeld, J.H. (2001). The effect of water on gas-particle partitioning of secondary organic aerosol. *Atmospheric Environment*, 35, 6073-6085.
- [2] Watson, J.G., Chow, J.C., Fujita, E.M. (2001). Review of volatile organic compounds source apportionment by chemical mass balance. *Atmospheric Environment*, 35, 1567-1584.
- [3] European Parliament Directive 2008/50/WE of 21 May 2008 on air quality and pure air for Europe.
- [4] Freemantle, M. (2005). Membranes For Gas Separation. *C&EN*, 83, 49-57.
- [5] Sakamoto, Y., Nagata, K., Yogo, K., Yamada, K. (2007). Preparation and CO<sub>2</sub> separation properties of amine modified mesoporous silica membrane. *Microporous and Mesoporous Materials*, 101, 303-311.



- [6] Cañizares, P., García-Gómez, J., Sáez, C., Rodrigo, M.A. (2003). Electrochemical oxidation of several chlorophenols on diamond electrodes Part I. Reaction mechanism. *J. Appl. Electrochem.*, 33, 917-927.
- [7] Toshihiko, M., Hiroshi, K. (2002). Electro-chemical Remediation of VOC Contaminated Water. *Report of Obayashi Corporation Technical Research Institute*, 65, 89-94.
- [8] Villagran, C., Banks, C.E., Hardacre, Ch., Compton, R.G. (2004). Electroanalytical determination of trace chloride in room-temperature ionic liquids. *Anal. Chem.*, 76, 1998-2003.
- [9] Gębicki, J., Kloskowski, A., Chachulski, B. (2010). Electrochemical sensor for measurement of volatile organic compounds in air. *Elektronika*, 6, 66-69.
- [10] Bond, A.M. (1980). *Modern Polarographic Methods in Analytical Chemistry*. New York: Marcel Dekker Inc.
- [11] Earle, M.J., Seddon, K.R. (2000). Ionic liquids. Green solvents for the future. *Pure Appl. Chem.*, 72 (7), 1391-1398.
- [12] Buzzeo, M.C., Hardacre, C., Compton, R.G. (2004). Use of room temperature ionic liquids in gas sensor design. *Anal. Chem.*, 76, 4583-4588.
- [13] Wei, D., Ivaska, A. (2008). Applications of ionic liquids in electrochemical sensors. *Anal. Chimica Acta*, 607, 126-135.
- [14] TGS 822, TGS 2201, Product Information, Figaro USA, Inc.
- [15] Jasiński, G. (2008). *Czujniki gazów toksycznych na bazie elektrolitów stałych modelowanie i optymalizacja konstrukcji. Ph.D. Thesis*. Gdansk University of Technology. (in Polish)
- [16] Kotarski, M., Smulko, J. (2009). Noise measurement setups for fluctuations enhanced gas sensing. *Metrol. Meas. Syst.*, 16(4), 457-464.
- [17] Cao, Q., Rogers, J.A. (2009). Ultrathin films of single-walled carbon nanotubes for electronics and sensors: a review of fundamental and applied aspects. *Adv. Mater.*, 21, 29-53.
- [18] Wu, F.H., Zhao, G.C., Wei, X.W. (2002). Electrocatalytic oxidation of nitric at multi-walled carbon nanotubes modified electrode. *Electrochem. Commun.*, 4, 690-694.
- [19] [www.istherno.nist.gov](http://www.istherno.nist.gov)
- [20] Osteryoung, J.G., Osteryoung, R.A., (1985). Square wave voltammetry. *Anal. Chem.*, 57, 101-110.
- [21] Cygański, A. (1991). *Podstawy metod elektroanalizy*. Warszawa: WNT. (in Polish)

