

# Estimation of electrode contact in capacitive ECG measurement

1<sup>st</sup> Adam Bujnowski

*Biomedical Engineering Department,  
Faculty of Electronics, Telecommunications  
and Informatics, Gdansk University of Technology*  
Gdansk, Poland  
adabujno@pg.edu.pl

2<sup>nd</sup> Mariusz Kaczmarek

*Biomedical Engineering Department,  
Faculty of Electronics, Telecommunications  
and Informatics, Gdansk University of Technology*  
Gdansk, Poland  
markaczm@pg.edu.pl

3<sup>rd</sup> Jerzy Wtorek

*Biomedical Engineering Department,  
Faculty of Electronics, Telecommunications  
and Informatics, Gdansk University of Technology*  
Gdansk, Poland  
jerzy.wtorek@pg.edu.pl

4<sup>th</sup> Kamil Osinski

*Biomedical Engineering Department,  
Faculty of Electronics, Telecommunications  
and Informatics, Gdansk University of Technology*  
Gdansk, Poland  
kamilosinski1@gmail.com

5<sup>th</sup> Dominika Strupinska

*Biomedical Engineering Department,  
Faculty of Electronics, Telecommunications  
and Informatics, Gdansk University of Technology*  
Gdansk, Poland  
dominika.str97@gmail.com

**Abstract**—In the paper a method of electrode's contact estimation in capacitive electrocardiogram (CECG) is presented. Proposed solution allows estimation of contact quality for each individual electrode. This enables construction of multi-electrode CECG systems, where electrode pairs can be selected on the basis of the individual electrode contact quality.

**Index Terms**—capacitive coupled electrocardiogram, electrode contact, biosignals, ambient assisted living

## I. INTRODUCTION

Capacitive-coupled electrocardiography is a technique that is widely explored nowadays [1]. One of most interesting applications is ubiquitous health care [2], [3]. By installing electrodes on the chair or bed it is possible to monitor ECG without need of galvanic electrode to skin contact [4], [5]. Despite very attractive and potentially useful [6], [7] application there are several problems that are still present [8]. In traditional ECG measurement electrodes are located on well defined regions of patient body. In CECG electrodes are located on furniture like chair or bed mattress. Thus electrode-to body position is in general unknown. It depends on person position taken on the chair or bed. Moreover electrodes are capacitively coupled usually through the clothes,

Research supported by The Ella4Life project - Co-funded by the European AAL Joint Programme and partially by Statutory Funds of Electronics, Telecommunications and Informatics Faculty, Gdansk University of Technology.

where kind of textile and number of layers is usually unknown. Monitored person motion is an additional source of error in such configuration [9]. Additional problems can be caused by need of active common signal feedback like DRL technique in traditional ECG. Here also capacitive coupling is applied. Various techniques can be applied to improve performance of the CMRR improvement [10].

Measurement system for CECG is usually oriented for heart-rate (HR) and its derivatives. In most cases it is composed of active and ultra-high impedance input stage embedded with sensing electrodes [8]. Adequate shielding of detecting parts is also key of proper measurement.

The measurement results are strongly dependent on the quality of contact. This might be altered by several factors such as the electrode to body distance affected by patient's position or number of clothes layers. Additionally measurement system never knows if the patient is in contact with electrodes and if it is measuring all the time - false reading and input noise can affect measured signal quality.

In the paper we introduce novel approach to estimate body-to electrode contact. Despite other systems where measurement is made between selected pair of electrodes, or electrode-to shield [11], [12], proposed solution utilizes split sensing electrode approach. It allows to design measurement systems where multi-electrode array is built and measurement is made between electrodes with best achievable contact.

The rest of the paper is organized as follows. In Section II principle of operation and additional constraints are presented. We are showing basic electrode construction together with some simulations. Finally a schematic of the electrode sensing probe is shown. Section III presents realized sensor probe and obtained performance. In section IV a summary of work and obtained results are presented.

## II. MATERIALS AND METHODS

### A. Principle of operation

The contact estimation can be established by various methods. Constrains that should be fulfilled are as follows:

- maintain high area of electrode to body contact,
- galvanic separation of contact measurement system from the electrode as bias of the input stage is utilizing very small currents
- signal utilized to estimate contact should not interfere with measured one
- system should allow to detect contact quality for single electrode

Quality of electrode contact to skin can be achieved by measurement of capacitance. It is possible to utilize electric permittivity of living body as indicator of contact quality. If the electrode plane can be divided into two pads (see Fig. 1). Measured capacitance between pads will be dependent on area of pads, distance between pads and electric permittivity of dielectric between two pads.

In case where electrode is surrounded by the air, equivalent capacity has lowest possible values. When it comes to contact with the body capacitance will grow depending on equivalent permittivity between pads. This will depend on distance of the body from pad surface which can be caused by movement and clothes layer thickness.

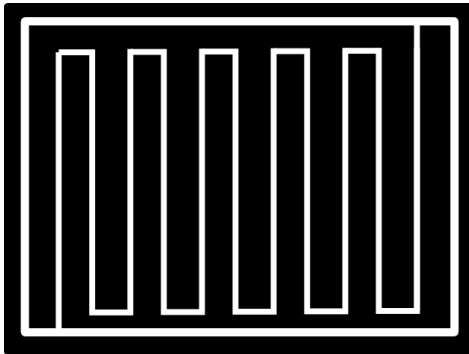

Fig. 1. Sensing electrode modification that allows contact estimation

It is also requested that for CECG signal one can utilize surface of two pads in common - to reduce coupling impedance and gain sensitivity, while for proximity estimation they should work separately. To fulfill this requirement an transformer can be utilized. Transformer primary inductance is causing separation of the sensing pads for high frequency, while for low frequency they are connected.

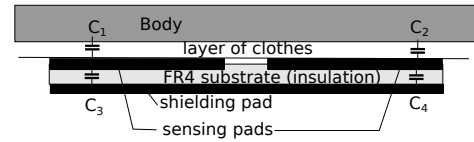

Fig. 2. Cross-section of proximity sensor and major components taking part in sensing

### B. Model analysis

The principle of operation is capacitance measurement between two parts of the electrode. For ECG measurement it is required that sensing electrode must be shielded. Presence of shield is causing additional capacitance - see Fig. 2.

Complete capacitance observed between sensing electrodes in mixed, series and parallel connection of  $C_1..C_4$ .

$$C_x = (C_1 || C_2) + (C_3 || C_4) \quad (1)$$

where  $C_1, C_2$  are capacitances dependent on proximity, while  $C_3$  and  $C_4$  are constant, independent on proximity. Operator  $||$  stands is calculated as:

$$C_x || C_y = \frac{C_x C_y}{C_x + C_y}$$

### C. Capacitance measurement

The proximity sensor is used to assist capacitive ECG (CECG) measurement and thus it's operation should not influence major functionality of device. Critical for CECG is biasing of the input amplifier. To achieve ultra-high input impedance special care is taken in order to select the operational amplifier and it's biasing circuitry.

We are proposing to measure capacitance by the L-C generator. By having known inductance the characteristic frequency of oscillation depends on C:

$$f = \frac{1}{2\pi\sqrt{LC}} \quad (2)$$

We can calculate C as:

$$C = \frac{1}{4\pi^2 f^2 L} \quad (3)$$

We can form simple LC generator utilizing the Colpitts topology with single NPN transistor in common base configuration. Schematic diagram of exemplary circuit is shown in Fig. 3. This canonical schematic utilizes  $C_x$  as sensor. Unfortunately there is no galvanic separation and if  $C_x$  is formed as a sensor pad it is biased at  $V_{cc}$  level preventing ECG circuitry from normal work.

We decided to substitute L by 1:1 transformer, which will prevent  $C_x$  to be biased. Additionally T is shorting two  $C_x$  sensing pads for low frequency. This allows us to increase area of CECG electrode by both  $C_x$  pads.



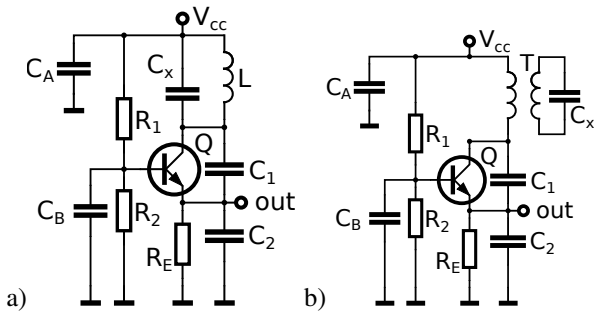

Fig. 3. Simple Colpitts LC generator a) and its modification preventing electrode's biasing b)



Fig. 4. Manufactured electrode

### III. RESULTS

#### A. Sensor

A capacitive sensor has been designed in vector graphics package (Inkscape) according to Fig. 1 and etched on FR4 type substrate. Total area of the PCB is  $85 \times 57 \text{ mm}^2 = 4845 \text{ mm}^2$  while effective area of the sensor is  $3450 \text{ mm}^2$ .

In air capacitance was measured by means of the RLC bridge.

Sensor capacitance was measured with various conditions by means of the RLC meter at 100kHz. Measurements were performed with presence of different dielectric materials in front of sensing electrodes. To simulate presence of the human body additional conductive plate (copper of non-etched PCB) was used. Setup can be illustrated in Fig. 5.

Copper plate was used to emulate presence of human body. When tested with presence of the human body we have obtained similar results with larger variance, but analysis of

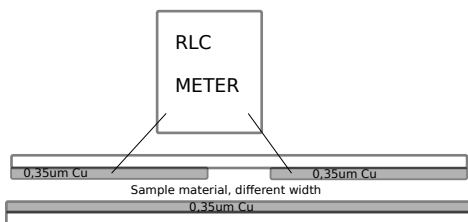

Fig. 5. Capacitance estimation vs different dielectric material

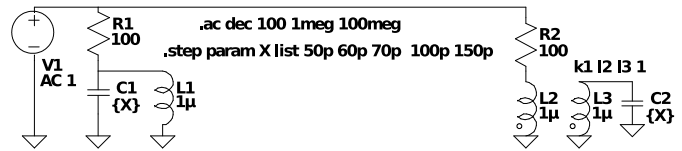

Fig. 6. Test schematic used for the simulation

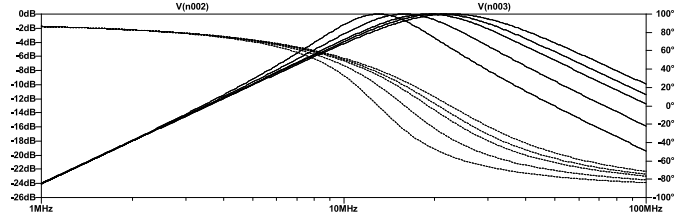

Fig. 7. Results of AC analysis, simultaneously LC and Transformer-C circuit. Note - results directly overlapping

the average values is giving the same results as with metal plate. Results are collected in Table I for details.

TABLE I  
CAPACITIVE SENSOR MEASUREMENTS

Material used	Measured capacitance [pF]
free air, no cover	33
Winter jacket multilayer	35
4 layer 80g/m <sup>2</sup> paper	57
2 layer 80g/m <sup>2</sup> paper	58
1 layer 80g/m <sup>2</sup> paper	63
kitchen paper towel	49
sweater 0.7mm thick	63
sweater 1.8mm thick	59

#### B. Generator

Generator circuit was simulated using LTSpice software. At first oscillation conditions were tested without transformer. It is shown that oscillation center frequency depends on resonant frequency of the  $L - C_x$  (see. Fig. 3a).

We have simulated performance of the transformer as a coupling device. In Fig. 6 a simplistic test of circuit's performance is shown. We wanted to test behavior of transformer coupled resonant circuit vs standard one. From Fig. 7 we can conclude that by using 1:1 transformer of the same inductance of winding as L we do not introduce any changes to spectral characteristic of the circuit.

This leads to conclusion that generator build on the basis of transformer coupled sensor should behave as non-coupled one. Simulation results from Fig. 8 and 10 prove the hypothesis.

In addition the step analysis was performed in order to check, whether sensor capacitance change can alter oscillation frequency, and what are expected changes.

In Fig. 11 expected frequency change versus  $C_x$  is shown.

The single transistor Colpitts generator has been designed, operating point was set and PCB was produced. In addition transformer was prepared by double sided PCB. Details are shown in Fig. 12.

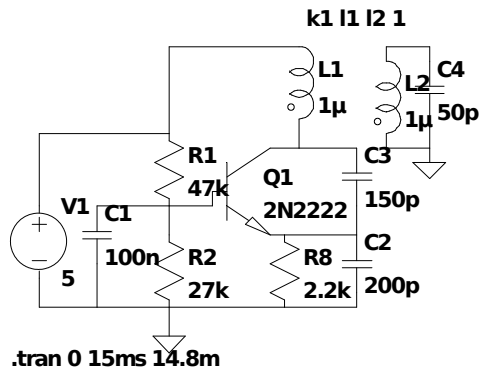

Fig. 8. Simulated circuit

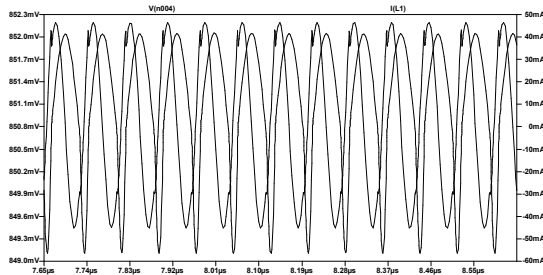

Fig. 9. Spice simulation of generator output signal - refer to Fig 8 voltage is measured on R8 and current in L1

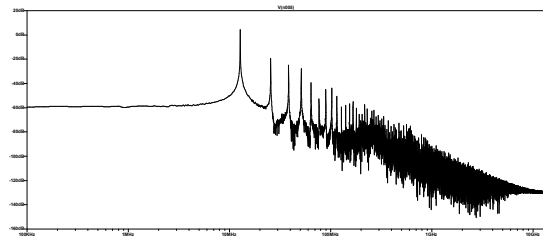

Fig. 10. Fourier transform of the output signal

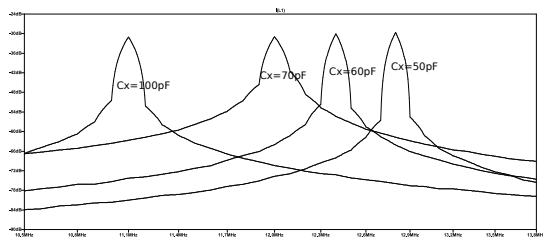

Fig. 11. Parametric analysis of the signal frequency versus sensor capacitance

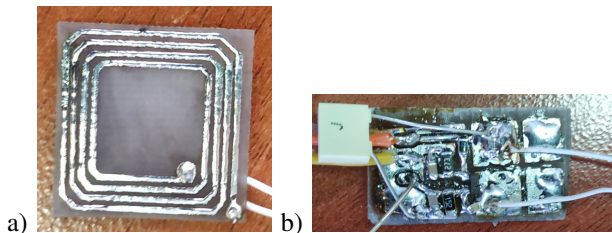

Fig. 12. Manufactured transformer, winding is the same on top and bottom a) and manufacturer Colpitts generator circuit b)

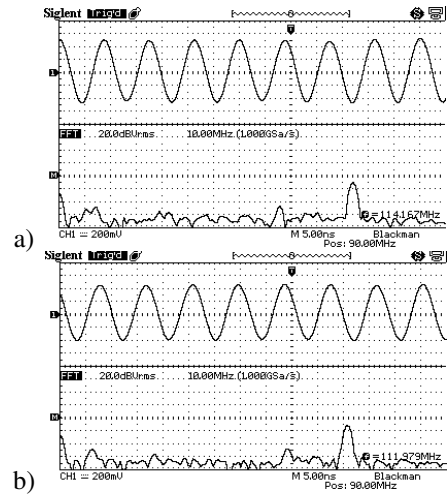

Fig. 13. Real measurements of the generator prototype; note frequency loss in b) caused body proximity

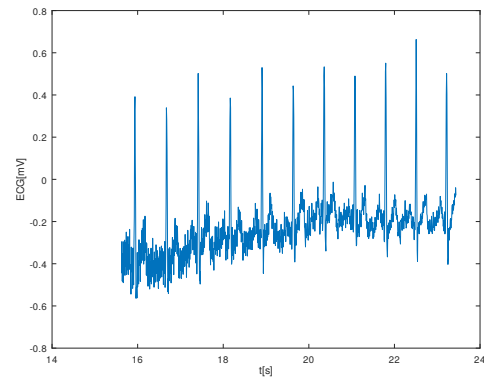

Fig. 14. Real ECG signal measured with proposed electrode

Simple measurement setup was created, where output signal was connected to the digital oscilloscope input and frequency was examined versus various dielectric materials simulating clothes. Exemplary output signal is shown in Fig.13 and results of the measurements are collected in Table II.

TABLE II  
FREQUENCY MEASURED FOR VARIOUS MATERIALS

Material used	Measured frequency [MHz]
free air, no cover	29.76
Free, temp raiser by 2C	30.12
4 layer 80g/m <sup>2</sup> paper	27.78
2 layer 80g/m <sup>2</sup> paper	28.09
1 layer 80g/m <sup>2</sup> paper	27.17

Finally one of electrodes of the CECG system designed in GUT was altered to check if presence proposed solution would alter measurement performance. Preliminary results are shown in Fig. 14.

Finally a complete electrode design was prepared. It is based on previous experiences with input buffer and proposed modifications related to contact quality estimation. The electrode

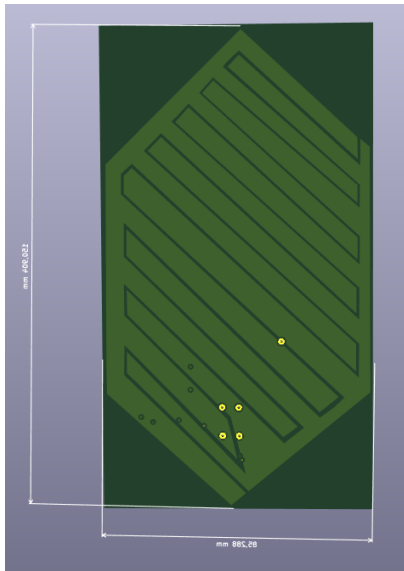

Fig. 15. Design of complete PCB for the single electrode - patient sensing part

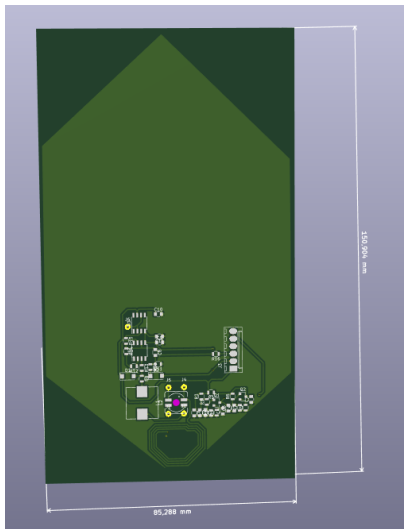

Fig. 16. Design of complete PCB for the single electrode - hidden electronics

was prepared as 4-layer PCB with transformer introduced on two neighboring layers. In Fig. 15 a patient coupling part is shown, while in Fig. 16 embedded electronics responsible for high impedance input and oscillator for contact quality estimation. Please observe flat coupling transformer designed on PCB. Two internal, hidden layers are not shown, they are acting as a active shielding. Currently PCB is in manufacturing process and following experiments will be scheduled right after boards assembly.

#### IV. DISCUSSION AND CONCLUSION

Presented measurement method utilizes fact that for low frequency components sensor can use two capacitor pads in common, while high frequency component and presence of the transformer allows measurement of the contact quality.

We have proposed small size flat shape air-core transformer and we have shown its applicability for such measurements. Finally real measurement was conducted proving correctness of proposed solution.

Unlike other presented systems contact quality can be estimated for each individual frequency. We also proposed methodology of DC separation for measured signals. The electrode's contact quality determines overall CECG system performance. We can estimate this value by means of the frequency change. Proposed measurement circuit must be improved as oscillation frequency is dependent on multiple factors like operating point of the transistor or it's junction temperature.

Future research should include construction of more robust generator circuitry and optimization of the electrode shape.

#### REFERENCES

- [1] A. Arcelus, M. Sardar, and A. Mihailidis. Design of a capacitive ecg sensor for unobtrusive heart rate measurements. In *2013 IEEE International Instrumentation and Measurement Technology Conference (I2MTC)*, pages 407–410, May 2013.
- [2] M. Kaczmarek, J. Ruminski, and A. Bujnowski. Multimodal platform for continuous monitoring of elderly and disabled. In *2011 Federated Conference on Computer Science and Information Systems (FedCSIS)*, pages 393–400, Sep. 2011.
- [3] Yong Gyu Lim, Jeong Su Lee, Seung Min Lee, Hong Ji Lee, and Kwang Suk Park. Capacitive measurement of ecg for ubiquitous healthcare. *Annals of Biomedical Engineering*, 42(11):2218–2227, Nov 2014.
- [4] Antje Pohl, Benjamin Eilebrecht, Tobias Wartzek, Marian Walter, and Steffen Leonhardt. Advances in modern capacitive ecg systems for continuous cardiovascular monitoring. *Acta Polytechnica*, 51:100 – 105, 01 2011.
- [5] Jianfeng Qiu. A chair embedded with capacitive electrocardiography (ecg) for non-obstructive cardiac health monitoring in the home setting. 2015.
- [6] H. Carey and M. Manic. Epileptic spike detection with eeg using artificial neural networks. In *Proc. of IEEE 9th International Conference on Human System Interaction, IEEE HSI 2016, Portsmouth, England, July 6-8, 2016*.
- [7] M. Manic K. Amarasinghe, D. Wijayasekara. Eeg based brain activity monitoring using artificial neural networks. In *Proc. of IEEE 7th International Conference on Human System Interaction, IEEE HSI 2014, Lisbon, Portugal, June 16-18, 2014*.
- [8] Y. Sun and X. B. Yu. Capacitive biopotential measurement for electrophysiological signal acquisition: A review. *IEEE Sensors Journal*, 16(9):2832–2853, May 2016.
- [9] Shuang Zhu, Jingyi Song, Balaji Chellappa, Ali Enteshari, Tuo Shan, Mengxun He, and Yun Chiu. A smart ecg sensor with in-situ adaptive motion-artifact compensation for dry-contact wearable healthcare devices. pages 450–455, 03 2016.
- [10] Adam Bujnowski, Mariusz Kaczmarek, Kamil Osiński, Marta Gońka, and Jerzy Wtorek. Capacitively coupled ecg measurements - a cmrr circuit improvement. In Hannu Eskola, Outi Väisänen, Jari Viik, and Jari Hyttinen, editors, *EMBECC & NBC 2017*, pages 1109–1112, Singapore, 2018. Springer Singapore.
- [11] Guochen Peng and Mark F. Bocko. A system for active compensation of motion artifacts in non-contact ecg sensing. *IEEE Life Sciences Newsletter*.
- [12] Jrg Ottenbacher and Stephan Heuer. *Motion Artefacts in Capacitively Coupled ECG Electrodes*, volume 25, pages 1059–1062. 01 2010.

