

EVALUATION OF THE USE OF M2M-TYPE NB-IOT AND LTE TECHNOLOGIES FOR MARITIME COMMUNICATION SYSTEMS

Slawomir Gajewski  *

Agnieszka Czapiewska 

Małgorzata Gajewska 

Gdansk University of Technology, Poland

* Corresponding author: slagaj@eti.pg.edu.pl (Sl. Gajewski)

ABSTRACT

The development of IoT (the Internet of Things) wireless transmission opens a new era in communication systems. In the next years, the development and implementation of IoT systems will be very dynamic. It can be seen that the solutions of LTE – NB-IoT (Long Term Evolution – Narrowband IoT) transmission devices are implemented in a wide range of terrestrial solutions, e.g. smart grids. This paper aims to analyse the possibility of the use of NB-IoT technology for maritime communication applications and partially, for some maritime safety solutions, based on signal coverage analysis at sea. An interesting approach is the comparison of the results of NB-IoT coverage to the classic cellular LTE-based communication systems. Proposed solutions are based on the practical implementation of a designed specialised data concentrator with implemented gateway and radio modems, for both NB-IoT technology as well as LTE. In the paper, analyses of radio link budget and propagation loss models for sea environment are presented. The coverage analysis is based on real measurements of the efficiency of transmissions using wireless modems implemented in the developed data concentrator.

Keywords: NB-IoT maritime solutions, NB-IoT coverage at sea, NB-IoT performance, sea propagation loss, CE2R, CE3R

INTRODUCTION

Solutions for maritime radio communications systems are currently limited by the coverage of available technologies and do not always keep up with the development of technologies commonly available for civil-public applications. Evolutionary changes in cellular systems (e.g. from 4G to 5G) are currently associated with the high pace of development of the M2M (Machine-to-Machine) communication techniques within the Internet of Things (IoT). These techniques (also called Machine-Type Communications – MTC) are currently perceived to be a group of solutions that can be used to an increasing extent, including solutions related to maritime communications (e.g. autonomous and controlled communications between

ships, persons, rafts and others), terrestrial stations in critical situations, and some maritime safety applications. It can be used as additional technology when searching for persons at sea. Additionally, it is possible to adapt the transmission of speech signals, but this would require changing standard marine applications.

This paper aims to analyse the possibility of using NB-IoT (Narrowband IoT) technology for maritime communication applications, based on signals coverage analysis at sea. The purpose of this article is not to demonstrate the superiority of NB-IoT over other solutions specifically dedicated to maritime safety applications, such as AIS/VDES (Automatic Identification system/VHF Data Exchange System). However, this solution can be perceived as a potentially additional solution, e.g. for

small sea vessels, as well as for other sensor solutions. IoT is also starting to be incorporated into wind energy systems [1, 2]. As wind farms are very often situated in the sea, there is a need to analyse the limits of the application of dedicated wireless solutions, e.g. NB-IoT.

This is all the more interesting as IoT transmissions can be narrowband, which guarantees favourable conditions for signal transmission over a large distance. Nowadays, IoT transmission is one of the most important development trends in wireless technology. It can be developed for specific solutions, required for different operating conditions, such as AMI (Advanced Metering Infrastructure), SCADA (Supervisory Control and Data Acquisition), HAN (Home Area Networks) and IoT. However, one of the most important application areas is transport, both on land and maritime.

Depending on signal transmission conditions, the proposed solutions have different characteristics, applications and requirements. Meeting these is possible by fulfilling the stringent technical requirements for the designed IoT devices, and their use is made possible by the use of wireless communication. It is known that the use of separately designed radio transmission technologies is expensive and requires enormous maintenance and management costs. Therefore, even in critical applications, it is beneficial to use existing solutions and communication infrastructure. This is perfect for land applications, where this infrastructure is well-developed. However, it is much worse in maritime conditions, where access to systems and infrastructure based on land is limited. However, it is known that seamen and ships use GSM (Global System for Mobile), UMTS (Universal Mobile Telecommunications Systems), LTE (Long Term Evolution) cellular radio communication systems, and (soon) 5G New Radio both for professional as well as private connections, especially in the maritime coastal zone. This is possible because the ranges of the coastal base stations of these systems are sufficient to ensure radio coverage at sea from a few to several kilometres. Under favourable wave propagation conditions, this can be even more. In particular, the development of 5G technology opens up completely new possibilities in the use of IoT transmission in maritime security systems, with the possibility of creating applications for maritime, terrestrial and satellite transmission with a large perspective for advanced 5G solutions, as proposed in [3]. In this paper, the author discusses advanced 5G technologies as potentially attractive solutions for maritime communications. The 5G system requirements which are important for maritime applications and advanced network technologies (such as softwarisation, virtualisation and network slicing) are analysed, which can be used to improve maritime communication reliability in different situations. Moreover, architectures are proposed for the implementation of 5G solutions dedicated to maritime communication.

It should be noted that, to date, IoT solutions have not been widely analysed in the context of maritime communication. There are few articles on sea-related IoT problems in the literature. Interesting considerations on maritime IoT applications can be found in [4], where the authors present the results of measurements of the quality of signals sent for IoT transmission using LTE. They show that, under favourable

conditions, the station's ranges can be as much as 15-20 km from the coast. In turn, the paper [5] describes solutions typically dedicated to maritime communication, with an indication of the challenges and requirements related to the professional use of such solutions in terrestrial and satellite transmission systems and for various maritime applications, e.g. eNavigation. The authors of [6] presented the concepts of IoT solutions for marine applications with a literature review. The paper found interesting considerations on different architectures for e-Navigation and marine monitoring, as well as discussions on the applications for monitoring ships, collision avoidance systems and automatic shipping applications. In [7], the possibilities of using IoT for the monitoring of sea buoys were analysed and the measurement results for the LoRa (Long Range Wide Area Network – LoRaWAN) radio interface were presented.

However, it should be emphasised that there are currently no studies in the literature concerning the use of NB-IoT technology for maritime transmission. At present, authors would rather discuss the use of wideband transmission technologies using GSM/UMTS/LTE cellular systems for IoT communication or technologies which are specifically dedicated to IoT, such as LoRa. We cannot find any considerations of transmissions based on NB-IoT technology, which is not in common use but its importance is growing day-by-day.

This paper aims to discuss the use of NB-IoT transmission for maritime applications, independently of the possible use of wideband LTE for IoT applications, and the comparison of the use of NB-IoT and LTE. This article presents the results of measurements and analysis of a data concentrator equipped with a receiver dedicated to transmissions at sea, which enables transmission through the use of various radio interfaces, the LTE and NB-IoT in particular.

The structure of this paper is as follows. Section II presents the basic characteristics of the proposed data concentrator. Section III presents the results of measurement tests of the receiver, in terms of its sensitivity and the achieved transmission rates. Section IV discusses the propagation models adopted for the analysis and the link budget. Section V presents the results of propagation loss analyses and coverage estimation, while Section VI presents the results of the range estimation with the use of ITU-R [8] (International Telecommunication Union – Radiocommunication Sector) propagation curves. Finally, in Section VII, we discuss the research conclusions and further work direction.

THE KODEŚ DATA CONCENTRATOR MODEL WITH NB-IOT AND LTE COMMUNICATION INTERFACES

The KODEŚ data concentrator [9] was developed at the Gdansk University of Technology at the Faculty of Electronics Telecommunications and Informatics. KODEŚ is dedicated to the concentration of data from different systems: AMI, IoT, SCADA and HAN. The architecture of KODEŚ is presented in Fig. 1.

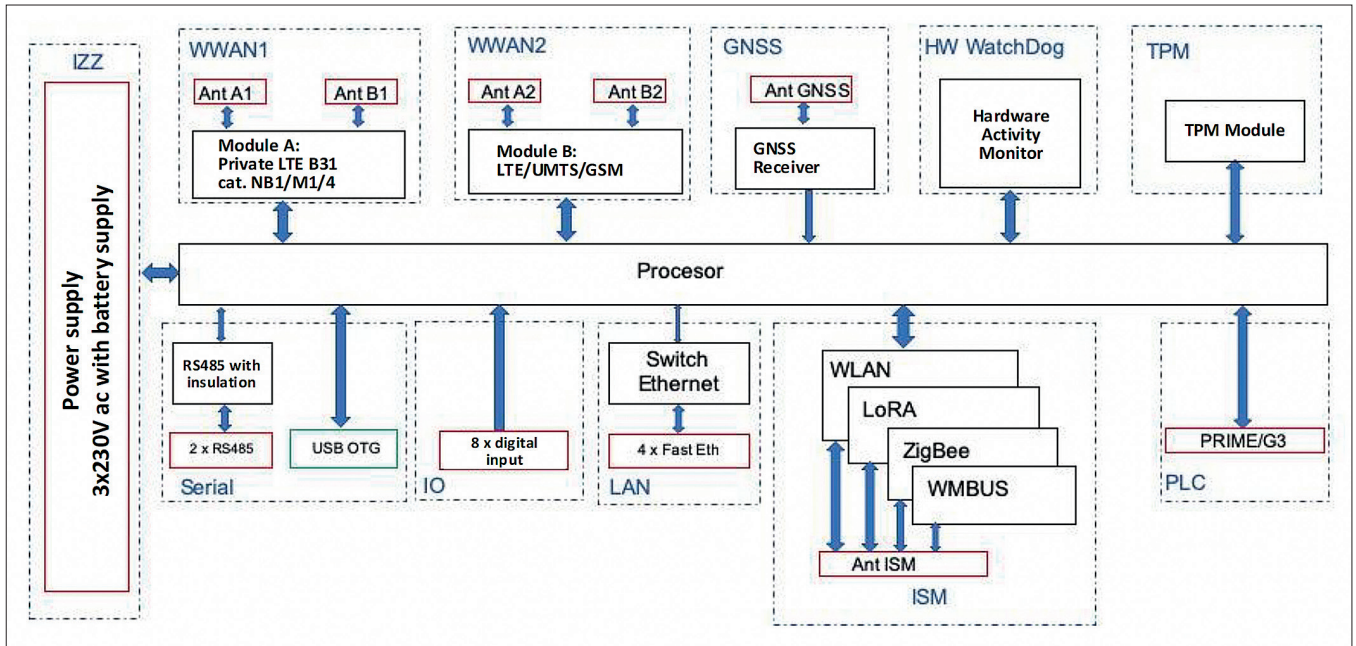

Fig. 1 Block diagram of the KODEŚ device [9]

KODEŚ was developed for terrestrial solutions but it has great potential as a device for other solutions, e.g. maritime communications. KODEŚ is equipped with functions capable of making independent decisions at the network interface (edge computing), gateway functions and the innovative so-called ‘Multilink Function’ (MF) [9]. This function enables a choice selection of radio interface for reliable communication using different systems, such as NB-IoT, LTE, UMTS, GSM and, in the future, 5G New Radio and 5G NB-IoT. The essence of MF is the automatic choice of the radio interface, based on different information from a network and given by standardised system parameters measured by the radio module. MF decides which communication interface should be used for particular data, based on the importance and amount of data, as well as link quality and availability. From the point of view of this paper, KODEŚ can use different radio interfaces divided into two groups, including cellular-public interfaces (LTE, UMTS, GSM) and NB-IoT [9].

environments in the case of our equipment). Measurements were performed automatically with the use of proprietary software [9]. The assigned power of the useful signal was changed during the measurements and the block error rate *BLER*, the obtained bit rate, and the signal delays were measured. Signal quality parameters specific to the NB-IoT technology were also read from the radio module: *RSRP* (Reference Signal Received Power), *RSRQ* (Reference Signal Received Quality), *RSSI* (Received Signal Strength Indicator) and *SNR* (Signal to Noise Ratio). For the experiment, the EPA (Extended Pedestrian A) channel model, was used with a nominal 200 kHz signal bandwidth. This model was used due to measure equipment limitations. It should be noted that it is better when the pulse response model corresponds more properly to maritime conditions. At this moment in time, this was not possible.

The results of the measurements of *BLER* as a function of *SNR* and throughput for a given link, dependent on *SNR*, are presented in Fig. 2 and Fig. 3.

MEASUREMENTS OF RECEIVER LIMITATIONS

NB-IOT

Measurements were made using a Rohde & Schwarz CMW500 radio communication tester and a Quectel BG95-M4 radio modem implemented with KODEŚ. The tester is the emulator of the LTE/UMTS/GSM and NB-IoT base station with the function of channel simulation using standardised channel model profiles, as defined by 3GPP (3rd Generation Partnership Project) [10]. The standardised models mainly concern the impulse response of the channel and the emulation of the Doppler effect in various propagation environments (urban

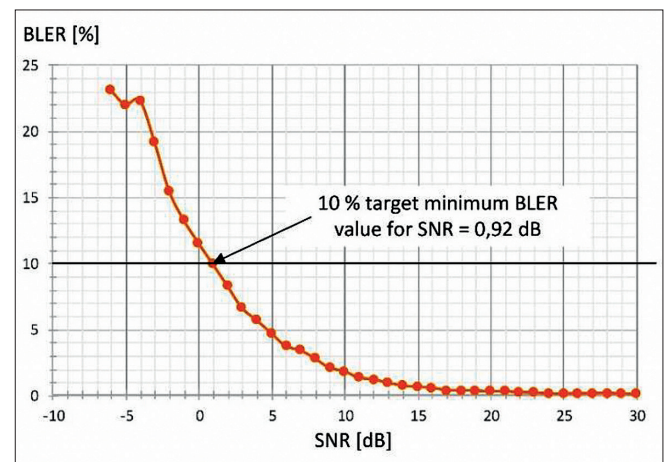

Fig. 2. Measured values of *BLER* as a function of *SNR* for NB-IoT radio module

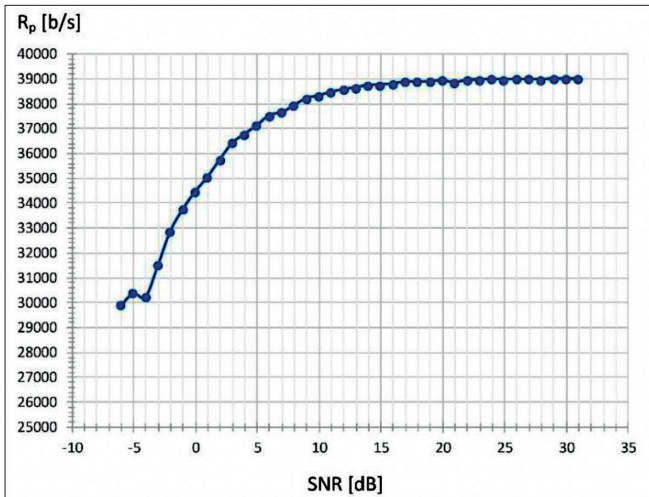

Fig. 3. Measured values of throughput R_p as a function of SNR for NB-IoT radio module

Fig. 2 shows that the target $BLER = 10^{-1}$ is achieved for SNR values not less than 0.92 dB. It can be seen that, if the SNR at the input of the receiver is greater, then we can transmit useful information without any problems and mistakes but, of course, it is necessary to make HARQ (Hybrid Automatic Repeat Request) retransmissions of a number of packets. The target $BLER$ of 10^{-1} is a typical value, considered during the coverage estimation and transmission performance evaluation in 4G systems with packet-switched signal transmission. From our measurements (presented in [9]), it can be seen that, for this value of $BLER$, the transmission with a relatively small number of packet retransmissions is possible. In general, we can define different $BLER$ target values. If we accept greater $BLER$ target values ($BLER > 10\%$) then the coverage will be extended, due to less acceptable SINR. If $BLER$ lower than 10% is accepted, then the coverage will be less than expected in this paper.

Therefore, the minimum acceptable value of SNR at the input of the receiver which gives an acceptable quality at the output, can be estimated for $BLER = 10^{-1}$. The usable sensitivity of the NB-IoT receiver can then be estimated. It must be noted that propagation conditions in a real maritime propagation environment are rather better than in the EPA model. This is because, in the maritime environment, we usually deal with a direct line of sight of antennas and a smaller number of multipath propagation components (impulse response components) due to the open nature of the environment. In such conditions, the received signal is much less distorted and the receiver works more efficiently. Thus, it will be able to receive the signal with the required error rate, even with slightly lower SNR values at the receiver input.

The estimated sensitivity of our receiver, based on $BLER$, was pessimistic one i.e. ranges at sea will, typically, be greater than those obtained by us in previous research. Thus, in practice, the values of the required SNR could be less than the measured values and the receiver sensitivity could be greater in a maritime coastal zone.

Moreover, Fig. 2 presents the throughput results for a given SNR. It can be seen that, in the case of NB-IoT, transmission rates are small and they can only be used for the transmission of short messages. If better rates are necessary, then LTE or another system (such as UMTS or GSM) should be used.

LTE

In the case of LTE, measurements were made using the same tester and the Quectel RM500Q-GL radio module. The measurements were made automatically with the use of proprietary software. The transmission was forced between the tester and the radio module in LTE under different operating conditions. We considered different modulation-coding schemes which were characteristic of the LTE radio interface and, before each transmission, the module measured the RSRQ, RSRP, and RSSI values. Then, during the transmission, these parameters were read again, in addition to the value of the actual MCS (Modulation-Coding Scheme) resulting from the module response time to the AT command and the parameters related to the quality of transmission measured in the tester: $BLER$ and bit rate. The same EPA channel model was used for the experiment and the devices always worked with a 10 MHz bandwidth. Depending on the series, the CQI (Channel Quality Indicator) was changed from 1 to 15, which defined the actual MCS value.

The $BLER$ and throughput measurement results are presented in Fig. 4, Fig. 5, Fig. 6 and Fig. 7 as a function of SNR.

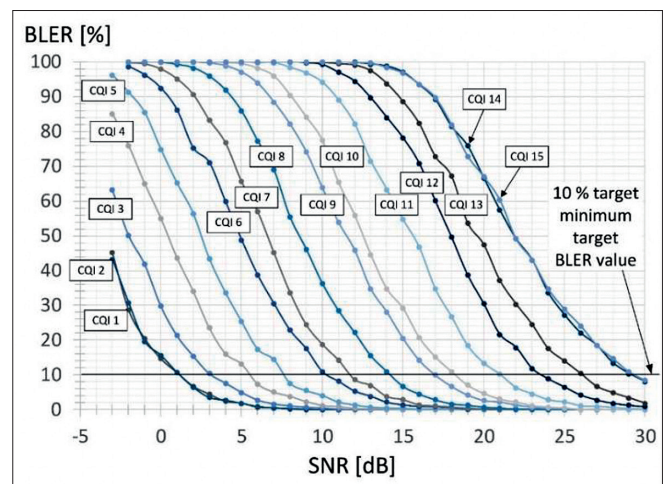

Fig. 4. Measured values of $BLER$ as a function of SNR for different values of CQI (LTE)

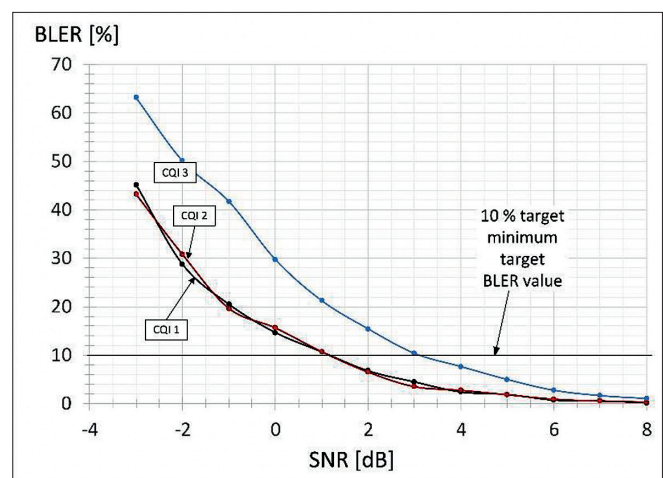

Fig. 5. Measured values of $BLER$ as a function of SNR for CQI from 1 to 3 (LTE)

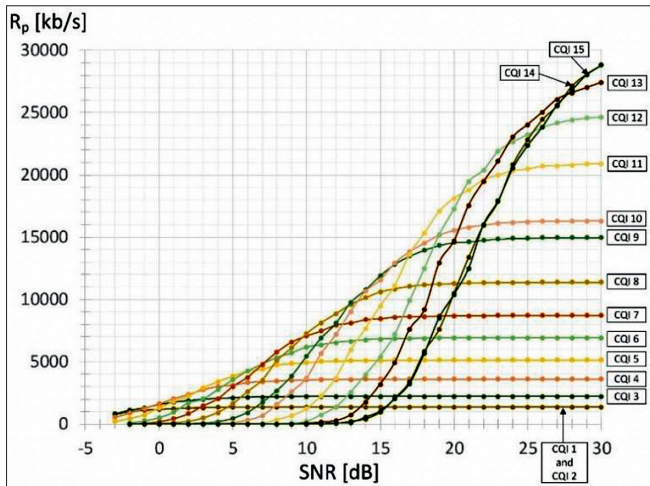

Fig. 6. Measured values of throughput R_p as a function of SNR, for different CQI (LTE)

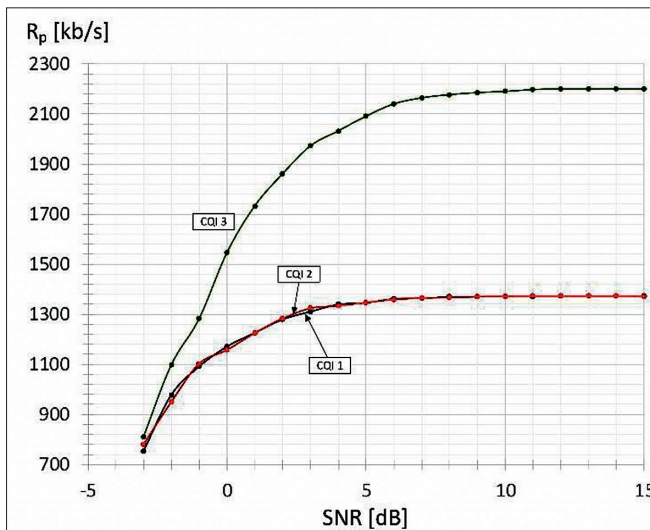

Fig. 7. Measured values of throughput R_p as a function of SNR, for CQI from 1 to 3 (LTE)

The problem in LTE is that the receiver sensitivity has to be defined for different CQI radio interface configurations. In general, for lower values of CQI, we used M -ary phase modulations of a small M (e.g. QPSK (Quadrature Phase Shift Keying)) which are characterised by greater transmission immunity on interference and other disturbances but with less spectral efficiency. For larger CQI values, there might be used 16QAM, 64QAM or 256QAM modulations (where QAM is Quadrature Amplitude Modulation) of better spectral efficiency compared to QPSK but lower immunity to interference. Thus, if we need greater rates then 64 QAM should be used (and so on), for which greater SNR is needed because the receiver sensitivity is small. However, the critical sensitivity for maximum signal coverage is defined for CQI = 1 (QPSK).

Fig. 4 and Fig. 5 show that the target $BLER$ is achieved for SNR values not less than 1.15 dB if we analyse basic transmission using QPSK modulation with CQI = 1. In this case, we can transmit useful information without any problems but with HARQ mechanisms. The target $BLER$ of 10^{-1} is a typical value for 4G. Thus, it can be used to estimate the minimum acceptable

value of SNR at the input of the receiver, giving an acceptable quality at the output given by $BLER = 10^{-1}$. So, it can be assumed the usable sensitivity of the receiver for the CQI = 1 modulation-coding scheme. As mentioned before, propagation conditions in a real maritime propagation environment are rather better than in the ETA model due to better propagation conditions in the maritime environment. This was explained in the previous section for NB IoT.

Thus, in practice, the values of the required SNR can be lower than the measured values and the receiver sensitivity can be greater in a maritime coastal zone; in some situations, it is possible to make a proper transmission with SNR less than zero at sea.

The throughput results for a given SNR and different CQI are presented in Fig. 6 and Fig. 7. Wideband LTE transmission gives much greater possibilities for achieving transmission rates compared to NB-IoT. Therefore, this interface is preferred for the transmission of a large amount of data.

RADIO WAVE PROPAGATION AT SEA AND LINK BUDGET

Many papers discuss different radio communication channel models [11-15]. Unfortunately, the literature lacks empirical models that would be reliably measured for marine applications and would be directly suitable for range estimates in a large frequency range. Therefore, many authors choose to consider the two-radius and three-ray models, in the case of curved earth, which is considered to be the best fit for marine applications. This is confirmed by the works in [13, 16-20]. In this paper, we decided to use the CE2R (Curved Earth 2-Ray) model and the CE3R (Curved Earth 3-Ray) model for sea propagation loss modelling. The motivation is that, in a sea environment, there may be large coverages which are sometimes greater than the radio horizon distance for earthbound waves. Thus, curved Earth models are strongly preferred, due to the large distances between transmitters and receivers, as well as a high altitude [13].

In the case of CE2R, the link loss model is given by

$$L_{CE2R} = -10 \log \left\{ \left[\frac{\lambda}{4\pi d} \right]^2 \left[2 \sin \left[\frac{2\pi h_t h_r}{\lambda d} \right] \right] \right\}^2 \quad (1)$$

where:

- λ – is the wavelength,
- h_t, h_r – is the transmitter and receiver antenna height, respectively,
- d – is the distance between the transmitter and the receiver.

Sometimes, the 3-Ray model of the channel over the water was also analysed. This model consists of one direct LOS (Line of Sight) component of a radio wave and two reflected paths. The first component is the wave reflected on the sea surface and it is, typically, the stronger component. The second component is the weaker, resulting from multiple sources and reflections, when we consider the additional transmission duct that was explained in [13]. In most cases, the CE2R model is considered sufficient, while the CE3R is rather optimistic.

The propagation loss model for CE3R is given by

$$L_{CE3R} = -10 \log \left\{ \left[\frac{\lambda}{4\pi d} \right]^2 \left[2 \left[1 + 2 \sin \left[\frac{2\pi h_t h_r}{\lambda d} \right] \sin \left[\frac{2\pi (h_e - h_t)(h_e - h_r)}{\lambda d} \right] \right] \right] \right\}^2 \quad (2)$$

where:

h_e – is the effective height of the evaporation duct (in the presented cases $h_e = 15$ m).

The link budget was constructed assuming typical values [10, 21] of both LTE and NB-IoT system parameters (see Table 1). The downlink connection was analysed when the base station transmitted a signal to the receiver located at sea. For this case study, we assumed the NSA (non-standalone) implementation of NB-IoT because, at this moment in time, it is the only version which can be used in Poland. Additionally, we analysed the GSM link budget for comparison.

Tab. 1. Link budget parameters

Parameter	NB-IoT	LTE	GSM
Band B [kHz]	200	10000	200
Transmitter antenna power P_{tx} [dBm]	30	30	30
Transmit antenna fider loss F_{tx} [dB]	2	2	2
Transmit antenna gain G_{tx} [dBi]	18	18	18
Receive antenna fider loss F_{rx} [dB]	2	2	2
Receive antenna gain G_{rx} [dBi]	3	3	3
Power of noise N [dBm]	-120.9	-103.9	-120.9
Receiver noise figure NF [dB]	5	5	5
Interference margin IF [dB]	2	2	0
Fading margin FM [dB]	13	13	13
SNR required SNR_{req} [dB]	0.92	1.15	18
Maximum accepted signal loss L_{max} [dB] (approximate)	147	130	132

The SNR_{req} values were taken from the measurements. The power of the base station transmitter is not too large because we analysed rather critical variants of transmission. On the other hand, we considered the 13 dB fading margin as significantly destroying the signal quality. In the case of NB-IoT, there was significantly less power of noise, compared to LTE, due to a relatively narrow band of signals transmitted. As the bandwidth for NB-IoT is the same as for GSM (200 kHz), the link budget for GSM was made.

As we can see, the maximum accepted signal loss in a radio link for NB-IoT is approximately 17 dB greater, compared to LTE, and 15 dB greater than the loss for GSM. This means that the signal coverage for NB-IoT can be significantly greater compared to both LTE and GSM.

COVERAGE ANALYSIS FOR CE2R AND CE3R MODELS

The analysis of propagation loss was made for frequencies [MHz]: 450, 900, 1800, 2400, 3600, 6000, and 28000. At the moment, not all of the frequency bands can be used for LTE and NB-IoT but this analysis aims to detect potential troubleshooting for the signal transmission on many frequencies, which are probably available for 5G.

Fig. 8 presents the results of propagation loss analysis using the CE2R model. The loss for frequencies from 450 MHz to 6 GHz is quite close and the maximum accepted signal loss for LTE is 130 dB. This means that the base station range using this model is 10.5 km. For NB-IoT we accept a signal loss of 147 dB and the projected range is 29.5 km (approximately **3 times** greater than the range for LTE). For comparison, it can be seen that the range for GSM, the CE2R model and the 132 dB maximum accepted loss, is 13 km – more than for LTE but much less than NB-IoT. For a frequency equal to 28 GHz, the range for LTE can be much less, compared to lower frequencies, while, for NB-IoT, this frequency can be accepted with a coverage of 28 km. Of course, lower frequencies are mostly preferred.

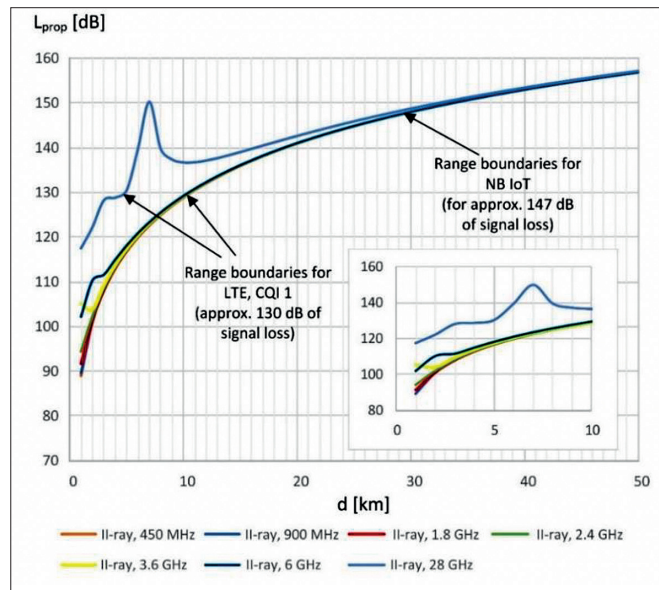

Fig. 8. Results of estimation of the propagation loss using the CE2R model for different frequencies

Results for the CE3R model are presented in Fig. 9. It can be seen that this propagation model is much more optimistic, compared to CE2R. Based on the CE3R model, it is impossible to clearly define the range limit due to its limitations because this range significantly exceeds the range of the radio horizon, which the CE2R model does not take into account. It means that the empirical verification of coverages is needed. The peaks on the curves result from the sinusoidal functions included in the model, which depend on the sine period, while the sine period depends on the wavelength (signal frequency). The effect is greater when the wavelength is small (for larger frequencies) because the wavelength is smaller than the base station antenna height.

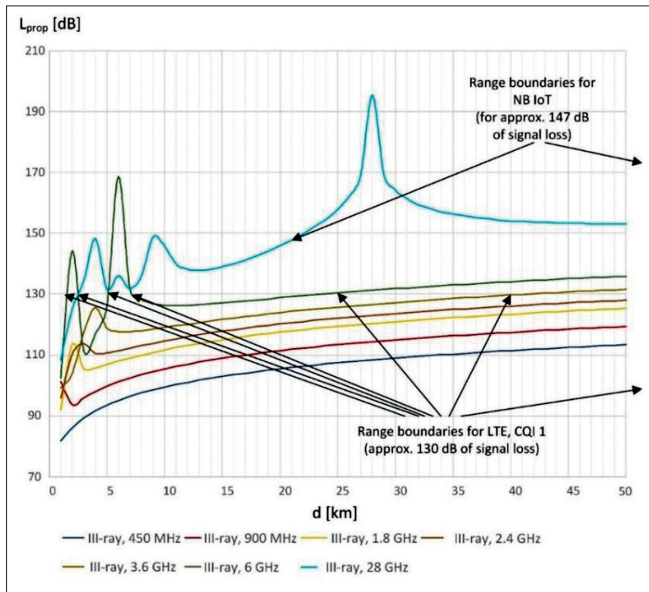

Fig. 9. Results of estimation of the propagation loss using the CE3R model for different radio wave frequencies; the far-right arrows in the figure indicate that the range limit for 147 dB and/or 130 dB propagation loss cannot be shown in the figure.

Results for the CE3R model are presented in Fig. 9. It can be seen that this propagation model is much more optimistic, compared to CE2R. Based on the CE3R model, it is impossible to clearly define the range limit due to its limitations because this range significantly exceeds the range of the radio horizon, which the CE3R model does not take into account. It means that the empirical verification of coverages is needed. The peaks on the curves result from the sinusoidal functions included in the model, which depend on the sine period, while the sine period depends on the wavelength (signal frequency). The effect is greater when the wavelength is small (for larger frequencies) because the wavelength is smaller than the base station antenna height.

If we analyse the planned system coverage at sea given by cellular operators (when the base station is located on a coast), we see that the CE2R model is rather more suitable for coverage estimation in a coastal zone. Fig. 9 shows that the coverage for LTE can be dependent on propagation loss fluctuations in the zone from 0 to a few (and up to 10 km for greater frequencies). While for 450 MHz ($L_{max} = 130$ dB), the range can be greater than 50 km. However, using this model, the real approximation is not possible because the estimated propagation loss is too small. The same problem holds for the NB-IoT required signal loss $L_{max} = 147$ dB, so we decided to analyse an additional method for coverage estimation in the next section.

COVERAGE ESTIMATION USING ITU-R EMPIRICAL CURVES

The method for coverage estimation suggested by ITU-R, for frequencies from 30 MHz to 4000 MHz, was presented in [8], where propagation curves are presented for different frequencies. These curves can be used to estimate usable coverage and

interference coverage. In the case of usable coverage, we take the curves for 50% of the time and 50% of the places measured for the sea environment. Because these curves present the dependence of electromagnetic field strength on the distance between a transmitter and a receiver, we need to estimate the equivalent field strength for the maximum signal losses calculated from the link budget. According to the recommendations [8], the equivalent can be calculated as:

$$E \left[dB \left(\frac{\mu V}{m} \right) \text{ for } 1kW e.r.p \right] = 139,3 - L_{prop} + 20 \log(f) \quad (3)$$

Using the rules for coverage estimation given in [8], we can estimate the coverages for different frequencies, as shown in Fig. 10. The frequencies are limited to 3.6 GHz due to the limitation of the ITU-R curves.

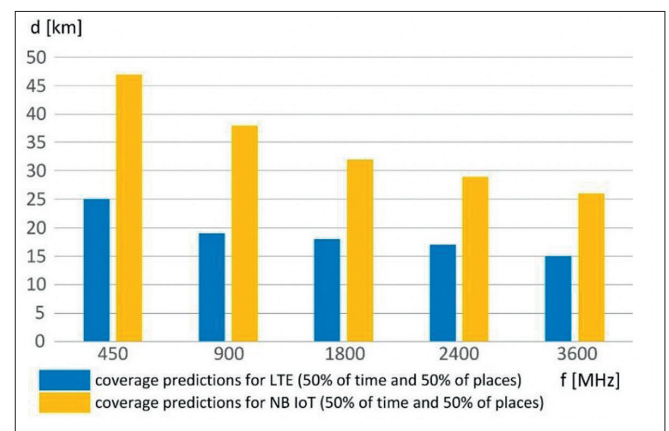

Fig. 10. Results of estimation of the coverage for LTE and NB-IoT transmission based on ITU-R propagation curves.

It can be seen that the coverage for 450 MHz can be more than 45 km for NB-IoT and 25 km for LTE while, for 900 MHz, the coverage was 37 km and 19 km, respectively. Even if the frequency of 3.6 GHz were used, the coverage for NB-IoT is more than 25 km.

A major conclusion from this analysis is that the coverage for NB-IoT can be almost two times greater than LTE. Thus, we see that NB-IoT technology can be recommended for maritime safety systems for transmission in the coastal zone and, at lower frequencies, it is possible to provide coverage up to 45 km from the coast.

CONCLUSIONS

In the paper, the analysis of NB-IoT system coverage in a sea environment is presented. As a result of the research project, the KODEŚ data concentrator was developed with advanced radio modems. This concentrator may be used for both terrestrial and maritime solutions. The presented analysis proves that NB-IoT signal transmission coverage outperforms LTE and GSM coverage. Therefore, NB-IoT utilisation for signal transmissions, for marine communication applications (as well as other maritime applications), is very promising. So

far, however, solutions based on NB-IoT are rather preferred for terrestrial applications. To the best of the authors' knowledge, there is a lack of publications on NB-IoT in the literature for marine applications.

Research has shown that the use of NB-IoT at sea, potentially allows ranges of up to 45 km from the coast, which guarantees good coverage for such applications for vessels located in the coastal zone of the sea. This range even exceeds the so-called radio horizon for earthbound waves. The actual and practical confirmation of the achieved results can be obtained by measurement tests conducted at sea, which are planned for the future.

ACKNOWLEDGEMENTS

This work has been carried out as part of the project entitled "Power data concentrator with innovative decision functionality and gate functionality in AMI, SCADA, HAN, IoT environments", co-financed under the European Regional Development Fund within the Smart Growth Operational Program, agreement no. POIR.01.01.01-00-0651/19-00 on 09.03.2020r.

REFERENCES

1. A. Mishra, R. Kumar, A.M. Khalkho and D.K. Mohanta, 'An IoT Integrated Reliability Estimation of Wind Energy System,' 2022 International Conference on IoT and Blockchain Technology (ICIBT), Ranchi, India, 2022, pp. 1-5, DOI: 10.1109/ICIBT52874.2022.9807704.
2. N.P.G. Bhavani, P. Vaishnavi and K. Sujatha, 'Off-shore wind power as a pillar of energy transmission using IOT (OSWPETIOT),' 2017 International Conference on Energy, Communication, Data Analytics and Soft Computing (ICECDS), Chennai, India, 2017, pp. 2494-2499, DOI: 10.1109/ICECDS.2017.8389901.
3. S. Gajewski, 'Maritime Communications Network Development Using Virtualised Network Slicing of 5G Network,' *Nase More*, Volume 67, No. 1. 2020, DOI: 10.17818/nm/2020/1.11.
4. K. Nybom, W. Lund, S. Lafond, J. Lilius, J. Björkqvist, K. Suominen, and K. Tuulos, 'IoT at Sea,' 2018 IEEE International Symposium on Broadband Multimedia Systems and Broadcasting (BMSB). June 2018, DOI: 10.1109/BMSB.2018.8436741.
5. T. Xia, M.M. Wang, J. Zhang, and L. Wang, 'Maritime Internet of Things Challenges and Solutions,' *IEEE Wireless Communications*, Volume: 27, Issue: 2. April 2020, DOI: 10.1109/MWC.001.1900322.
6. S. Ma, R. Yang, Y. Zuo, Y. Xiao, and T. Li, 'A Review of Internet of things on sea,' *IEEE*, 2021 International Conference on Security, Pattern Analysis, and Cybernetics (SPAC). June 2021, DOI: 10.1109/SPAC53836.2021.9539904.
7. M. Sandra, S. Gunnarsson, and A.J. Johansson, 'Internet of Buoys: An Internet of Things Implementation at Sea,' *IEEE*, 2020 54th Asilomar Conference on Signals, Systems, and Computers. November 2020, DOI: 10.1109/IEEECONF51394.2020.9443538.
8. Recommendation ITU-R P.15-46-6 (08/2019), 'Method for point-to-area predictions for terrestrial services in the frequency range 30 MHz to 4000 MHz,' P Series Radiowave propagation. ITU-R Radiocommunication Sector of ITU. 2019.
9. R. Burczyk, A. Czapiewska, M. Gajewska, and S. Gajewski, 'LTE and NB-IoT Performance Estimation Based on Indicators Measured by the Radio Module,' *Electronics*, Volume 11. September 2022, DOI: 10.3390/electronics11182892.
10. 3GPP TS 36.116, Evolved Universal Terrestrial Radio Access (E-UTRA); Relay radio transmission and reception (Release 17).
11. X. Wang and S. Zhang, 'Evaluation of multipath signal loss for AIS signals transmitted on the sea surface,' *Ocean Engineering*, Volume 146, Pages 9-20. December 2017.
12. H. Arafat and M. Sangman, 'Wireless Channel Models for Over-the-Sea Communication: A Comparative Study,' *Applied Sciences*. January 2019, DOI 10.3390/app9030443.
13. J. Wang, H. Zhou, Y. Li, Q. Sun, Y. Wu, S. Jin, T.Q.S. Quek, and C. Xu, 'Wireless Channel Models for Maritime Communications,' *IEEE Access* (Volume: 6). November 2018, DOI: 10.1109/ACCESS.2018.2879902.
14. S.-W. Jo, J. H. Jang, and W.-S. Shim, 'An analysis of path loss models of LTE-Maritime for mobile communication system in maritime environments,' *IEEE 22nd International Symposium on Wireless Personal Multimedia Communications (WPMC)*. November 2019, DOI: 10.1109/WPMC48795.2019.9096094.
15. A. Mitayani, G.N. Nurkahfi, M.M.M. Dinata, V.A. Mardiana, N. Armi, C.B.A. Wael, and A.S. Satyawan, 'Path Loss Model of the Maritime Wireless Communication in the Seas of Indonesia,' *IEEE*, 2020 International Conference on Radar, Antenna, Microwave, Electronics, and Telecommunications (ICRAMET). November 2020, DOI: 10.1109/ICRAMET51080.2020.9298652.
16. D.W. Matolak and R. Sun, 'Air-Ground Channel Characterization for Unmanned Aircraft Systems – Part I: Methods, Measurements and Models for Over-Water Settings,' *IEEE Transactions on Vehicular Technology*, Volume: 66, Issue: 1. January 2017, DOI: 10.1109/TVT.2016.2530306.



17. S. Gajewski, 'Design of OFDM-based Radio Communication Systems for Coast-to-Sea and Coast-to-Air Propagation Environments', Polish Maritime Research 23. April 2016, DOI: 10.1515/pomr-2016-0002.
18. M. Zhu, X. Zhao, and Y. Zhang, 'Study on a Sea Radio-wave Propagation Loss Model', IEEE, 2010 International Conference on Communications and Mobile Computing. April 2010, DOI: 10.1109/CMC.2010.57.
19. Y.H. Lee, F. Dong, and Y.S. Meng, 'Near Sea-Surface Mobile Radiowave Propagation at 5 GHz: Measurement and Modeling', Radioengineering, Vol, 23, No. 3. September 2014.
20. M. Pinem, N. Syafrudin, A., H. Rambe, S. Suherman, and M. Zulfin, 'Characterization of Path Loss for Radio Wave Propagation Over the Sea in 4G Network', IEEE, 2020 4th International Conference on Electrical, Telecommunication and Computer Engineering (ELTICOM). September 2020, DOI: 10.1109/ELTICOM50775.2020.9230500.
21. H. Holma and A. Toskala, 'LTE for UMTS: Evolution to LTE-Advanced, 2nd Edition', Wiley, March 2011.

