

## EXAMPLE OF TENSION FABRIC STRUCTURE ANALYSIS

ANDRZEJ AMBROZIAK AND PAWEŁ KŁOSOWSKI

*Department of Structural Mechanics and Bridge Structures,  
Faculty of Civil and Environmental Engineering,  
Gdansk University of Technology,  
Narutowicza 11/12, 80-233 Gdansk, Poland  
{ambrozan, klosow}@pg.gda.pl*

(Received 23 August 2009; revised manuscript received 13 February 2010)

**Abstract:** The aim of this work is to examine two variants of non-linear strain-stress relations accepted for a description of the architectural fabric. A discussion on the fundamental equations of the dense net model used in the description of the coated woven fabric behaviour is presented. An analysis of tensile fabric structures subjected to dead load and initial pretension is described.

**Keywords:** architectural fabric, material modeling, Murnaghan model

### 1. Introduction

The principal material used for constructing tension fabric structures (TFS) is a coated woven fabric called architectural fabric. The fabric is made of woven fibres (warp and weft) covered by a coating material, see Figure 1. Most of the technical woven fabrics are made of nylon, polyester, glass or aramid fibre nets covered by coating materials such as PVC, PTFE, or silicone. Additionally, it is possible to use architectural fabrics with some special features, *e.g.* high light transmission, surface coating with a self-cleaning photocatalyst or superhydrophobic material, *etc.*

The description of coated woven fabric deformation is the most important problem concerning materials modelling. Developing a realistic constitutive model to describe the material's behaviour has been the main objective of research for the last decades. Great progress in the computational tools gives new perspectives to the evolution of constitutive models, however, the practical engineering applications of some models are limited due to difficulties with identification procedures (*e.g.* large number of parameters of a material). A brief characterization of the constitutive models which have been proposed for the last decades for material modeling of a coated woven fabric is given.

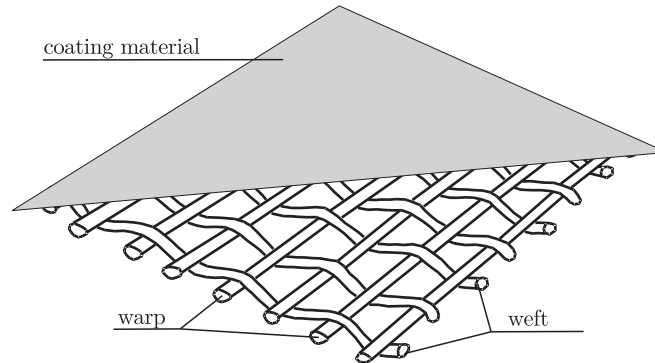

**Figure 1.** Visualisation of coated woven fabric

Stubbs and Fluss [1] have described a coated fabric element by a stable geometrically nonlinear space truss. The solution is determined by solving the system's equations using the secant method. Experimental results are presented to demonstrate the predictive capability of the model. Stubbs and Thomas [2] have developed a nonlinear elastic constitutive model for coated fabrics. The model which accounts for the basic mechanisms of yarn rotation, yarn extension and coating extension is obtained by expressing the equations of equilibrium for a unit cell of the material. Argyris *et al.* [3, 4] have presented constitutive viscoelastic modelling including experimental testing procedures, and identification of rheological parameters for a PVC-coated fabric. Kato *et al.* [5] have proposed the formulation of continuum constitutive equations for fabric membranes. The formulation is based on a fabric lattice model where the structure of fabric membranes is replaced by an equivalent structure composed of truss bars representing yarns and coating material. Kuwazuru and Yoshikawa [6] have described a pseudo-continuum model. This model transforms deformations of a fabric into the axial tensile strain and transverse compressive strain, separately for warp and weft. Xue *et al.* [7] have presented a non-orthogonal constitutive model for characterizing woven composites. The relationships between the stresses and strains are obtained on the basis of a stress and strain analysis in orthogonal and non-orthogonal coordinates and rigid body rotation matrices. King *et al.* [8] have proposed a continuum model. The fabric structural configuration is related to macroscopic deformation through an energy minimization method, and is used to calculate the internal forces carried by the yarn families. Pargana *et al.* [9] have proposed a unit cell approach. The base fabric model consists of a series of non-linear elastic and frictional elements and rigid links to represent the yarns. The fabric coating is modelled as an isotropic plate. Galliot and Luchsinger [10] have proposed a simple model based on experimental observations of the yarn-parallel biaxial extension of a PVC-coated polyester fabric. A linear relationship is experimentally found between elastic modules and normalized load ratios. The material behaviour is assumed to be plane stress orthotropic for a particular load ratio, while the elastic properties can vary with the load ratio in order to represent the

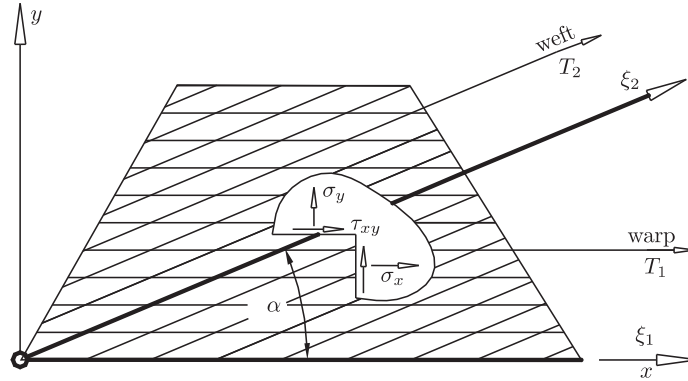

Figure 2. Thread forces in dense net model

complex interaction between warp and fill yarns. Among these approaches, the dense net model used in this paper can also be mentioned.

## 2. Constitutive architectural fabric model

To describe the behaviour of a coated woven fabric the authors applied the dense net model (see [11, 12]). In this model, stresses  $T_1$  and  $T_2$  (stresses in warp and weft thread families, see Figure 2) depend on the strains in the same family only:

$$\begin{aligned} T_1 &= F_1(\gamma_1) \cdot \gamma_1 \\ T_2 &= F_2(\gamma_2) \cdot \gamma_2 \end{aligned} \quad (1)$$

where  $F_1(\gamma_1)$  kN/m and  $F_2(\gamma_2)$  kN/m specify the tensile stiffness of the warp and weft threads,  $\gamma_1$  and  $\gamma_2$  define the strains along thread families (along warp and weft threads) and are defined by components of strains in the plane stress state:

$$\begin{Bmatrix} \gamma_1 \\ \gamma_2 \end{Bmatrix} = \begin{bmatrix} 1 & 0 & 0 \\ \cos^2 \alpha & \sin^2 \alpha & \sin \alpha \cos \alpha \end{bmatrix} \begin{Bmatrix} \varepsilon_x \\ \varepsilon_y \\ \gamma_{xy} \end{Bmatrix} \quad (2)$$

The parameters,  $F_1(\gamma_1)$  and  $F_2(\gamma_2)$ , are experimentally determined from uniaxial tensile tests in the warp and weft direction, respectively. In this approach it is possible to use different types of thread behaviour: nonlinear elastic, viscoplastic and viscoelastic. In the present paper two variants of the non-linear elastic approach are used to describe the behaviour of an architectural fabric. The identification process is presented in detail in papers [13] and [14]. On the other hand, in paper [15], the authors have proposed nonlinear viscoelastic behaviour to describe the fabric material.

The relation between components of the membrane forces in the plane stress state in the local coordinates  $(x, y)$  can be calculated from the equation ([11, 12]):

$$\begin{Bmatrix} \sigma_x \\ \sigma_y \\ \tau_{xy} \end{Bmatrix} = \begin{bmatrix} 1 & \cos^2 \alpha \\ 0 & \sin^2 \alpha \\ 0 & \sin \alpha \cos \alpha \end{bmatrix} \begin{Bmatrix} T_1 \\ T_2 \end{Bmatrix} \quad (3)$$

Following, it is possible to write:

$$\begin{Bmatrix} \sigma_x \\ \sigma_y \\ \tau_{xy} \end{Bmatrix} = \underbrace{\begin{bmatrix} 1 & \cos^2 \alpha \\ 0 & \sin^2 \alpha \\ 0 & \sin \alpha \cos \alpha \end{bmatrix} \begin{bmatrix} F_1(\gamma_1) & 0 \\ 0 & F_2(\gamma_2) \end{bmatrix} \begin{bmatrix} 1 & 0 & 0 \\ \cos^2 \alpha & \sin^2 \alpha & \sin \alpha \cos \alpha \end{bmatrix}}_{[D]} \begin{Bmatrix} \varepsilon_x \\ \varepsilon_y \\ \gamma_{xy} \end{Bmatrix} \quad (4)$$

where  $[D]$  defines the elasticity matrix and is expressed by the formula:

$$[D] = \begin{bmatrix} F_1(\gamma_1) + F_2(\gamma_2) \cdot \cos^4 \alpha & F_2(\gamma_2) \cdot \sin^2 \alpha \cdot \cos^2 \alpha & F_2(\gamma_2) \cdot \sin \alpha \cdot \cos^3 \alpha \\ F_2(\gamma_2) \cdot \sin^2 \alpha \cdot \cos^2 \alpha & F_2(\gamma_2) \cdot \sin^4 \alpha & F_2(\gamma_2) \cdot \sin^3 \alpha \cdot \cos \alpha \\ F_2(\gamma_2) \cdot \sin \alpha \cdot \cos^3 \alpha & F_2(\gamma_2) \cdot \sin^3 \alpha \cdot \cos \alpha & F_2(\gamma_2) \cdot \sin^2 \alpha \cdot \cos^2 \alpha \end{bmatrix} \quad (5)$$

It should be noted that the angle  $\alpha$  (see Figure 2) between warp and weft thread families changes during the deformation and may be calculated from the following equation:

$$\alpha = \text{atan} \left( \sigma_y / \tau_{xy} \right) \quad (6)$$

It should be noted that the initial angle  $\alpha = \alpha_0$  must be specified. This angle is equal to  $90^\circ$  for most coated woven fabrics. This parameter is dependent on the kind of woven and initial stresses. Typical biaxial weave pattern styles for  $\alpha_0 = 90^\circ$ , woven fabrics, are shown in Figure 3.

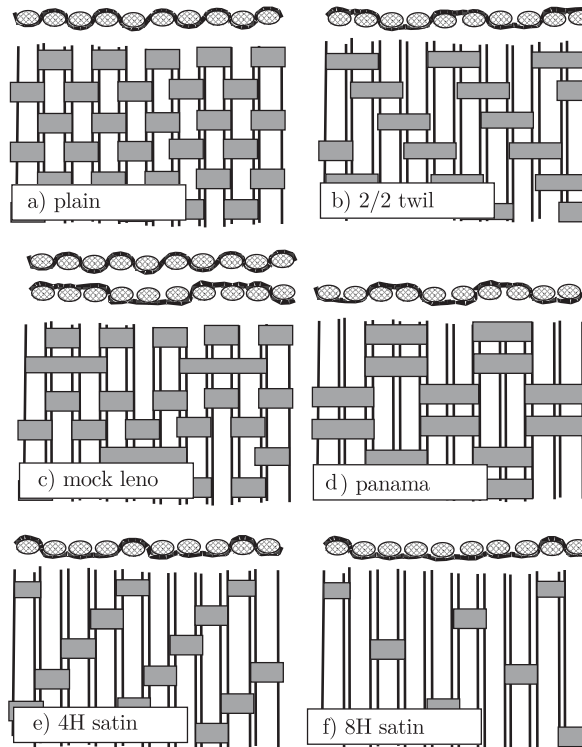

Figure 3. Typical biaxial weave pattern styles [16]

### 3. Structure description

Geometrically non-linear calculations of a hyperbolic paraboloid TFS with edge ropes (see Figure 4), with non-linear strain-stress relations applied for a coated woven fabric, were performed. This structure of a doubly ruled surface, shaped like a saddle, is more and more often used nowadays, due to its structural properties merit, see, *e.g.* [17, 18]. The vertical roof surface coordinates of the initial configuration can be computed from the following equation:

$$Z(X, Y) = \frac{H_1 - H_2}{A^2} \cdot X^2 + \frac{H_1}{A^2} \cdot Y^2 - H_1 \quad (7)$$

where  $H_1$  is the height at the centre point,  $H_2$  is the height at the maximum height point,  $2A$  is the diagonal horizontal span,  $X$ ,  $Y$ ,  $Z$  are the global coordinate system axes. Edge cables in the initial configuration are assumed as a second-order parabolic shape, see Figure 4.

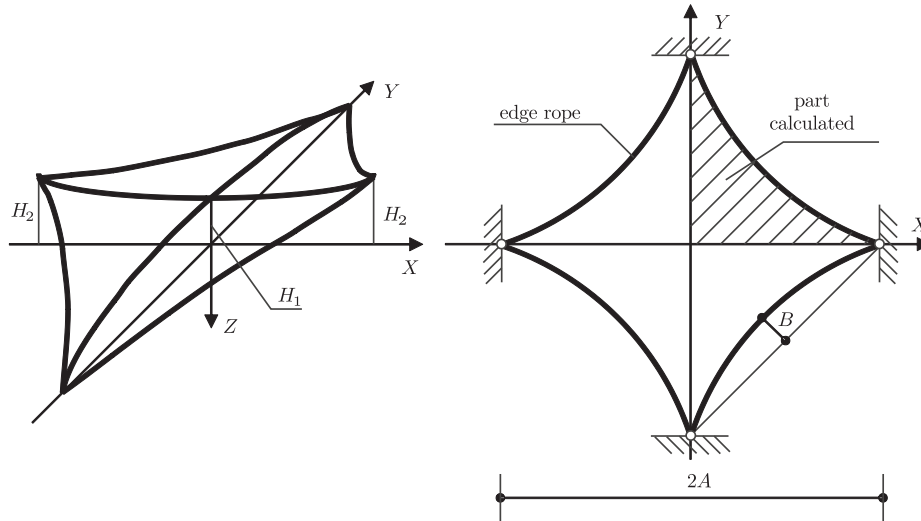

Figure 4. Roof geometry

Table 1. Panama fabric properties

	Value and unit
UTS <sub>warp</sub>	75 [kN/m]
UTS <sub>weft</sub>	60 [kN/m]
weight	870 [g/m <sup>2</sup> ]

The geometrical data for the example are:  $A = 20$  m;  $H_1 = 2$  m;  $H_2 = 4$  m and  $B = 2$  m (see Figure 4). The coated woven Panama fabric, assumed for these calculations, is made as a polyester base fabric coated with PVC. The weight and ultimate tension strength values are given in Table 1. The warp and weft threads of the fabric have the global coordinate system  $XY$  directions (warp –  $X$  and

weft –  $Y$  direction) in plane. A steel edge rope, 12 mm in diameter, was taken. The initial ropes force of 50 kN were used.

The numerical analysis was performed in two variants of the non-linear elastic strain-stress relation:

- **NLS\_P** – the non-linear elastic of the piecewise stress-strain relation. The tensile stiffnesses of the warp and weft threads are taken directly from Table 2.
- **NLS\_M** – the non-linear elastic Murnaghan model relation. In this case, the tensile stiffnesses of the warp and weft threads are determined as derivations of potential energy:

$$F_i = \frac{\partial}{\partial \gamma_i} \left( \frac{\partial \Phi}{\partial \gamma_i} \right) \quad (8)$$

The potential energy  $\Phi$  is accepted in the form [19]:

$$\Phi = \frac{\lambda + 2\mu}{2} (I_{\mathbf{E}})^2 - 2\mu II_{\mathbf{E}} + \frac{l + 2m}{3} (I_{\mathbf{E}})^3 - 2m(I_{\mathbf{E}}) II_{\mathbf{E}} + n III_{\mathbf{E}}. \quad (9)$$

where:  $\lambda, \mu$  are the Lamé constants;  $l, m, n$  are the Murnaghan constants, and  $I_{\mathbf{E}}, II_{\mathbf{E}}, III_{\mathbf{E}}$  are the invariants of the Lagrange-Green strain tensor. The mean values of the Murnaghan model coefficients are shown in Table 3.

**Table 2.** Non-linear elastic properties of coated fabric Panama [14]

	[kN/m]	[-]
Warp	$F_1(\gamma_1) = 904$	$\gamma_1 \in \langle 0 \div 0.0119 \rangle$
	$F_1(\gamma_1) = 176$	$\gamma_1 \in \langle 0.0119 \div 0.093 \rangle$
	$F_1(\gamma_1) = 471$	$\gamma_1 \in \langle 0.093 \div 0.180 \rangle$
Weft	$F_2(\gamma_2) = 187$	$\gamma_2 \in \langle 0 \div 0.039 \rangle$
	$F_2(\gamma_2) = 146$	$\gamma_2 \in \langle 0.039 \div 0.1495 \rangle$
	$F_2(\gamma_2) = 340$	$\gamma_2 \in \langle 0.1495 \div 0.24 \rangle$

**Table 3.** Murnaghan coefficients for PVC-coated Panama fabric [13]

	$\lambda$ [kN/m]	$\mu$ [kN/m]	$l$ [kN/m]	$m$ [kN/m]	$n$ [kN/m]
Warp	188.9	-146.2	313.3	6366.0	634.4
Weft	48.2	-24.4	453.6	1781.2	-43.1

#### 4. Pre-analysis of structure

One of the most important problems is to choose a proper value of the structure initial pretension forces. It is necessary to select a proper value of the initial pretension forces applied in the warp and weft directions, and also in cables. Wrong assumptions of pretension forces in the fabric can cause membrane wrinkling and also change the assumed shape of the structure, see *e.g.* [20].

The choice of force for this structure type is discussed in [12]. The initial pretension forces in the hyperbolic paraboloid tension structure must fulfil the following equation:

$$\overset{\circ}{T}_1 \frac{\partial^2 Z(X,Y)}{\partial X^2} + \overset{\circ}{T}_2 \frac{\partial^2 Z(X,Y)}{\partial Y^2} = 0 \tag{10}$$

where  $\overset{\circ}{T}_1, \overset{\circ}{T}_2$  are horizontal components of pretension forces in the warp and weft directions,  $Z(X,Y)$  are the vertical coordinates of the roof surface defined by Equation (7).

Consequently, the relation between pretension forces can be rewritten as:

$$\overset{\circ}{T}_1 = \frac{H_1}{H_2 - H_1} \overset{\circ}{T}_2 \tag{11}$$

For the analysed structure we can assume that (shallow structure):

$$\overset{\circ}{T}_1 \approx T_1, \quad \overset{\circ}{T}_2 \approx T_2 \tag{12}$$

Therefore, the values of pretension forces for the geometric parameters used in the calculations can be determined as:

$$T_1 = \frac{2}{4-2} T_2 = T_2 \tag{13}$$

It is assumed that the value of  $T_2 = 6.0$  kN/m, therefore,  $T_1 = 6.0$  kN/m from Equation (13) is accepted for the analysed structure pretension forces in the initial configuration in the warp direction.

Due to the symmetry of the geometry and loadings, it is sufficient to analyse only a quarter of the roof with proper symmetry boundary conditions at  $X = 0$  and  $Y = 0$  coordinates. At the beginning of the numerical analysis, a convergence analysis of the FE mesh was performed. Basing on this calculations, the mesh of  $12 \times 12$  elements (see Figures 5 and 6) was accepted. The length parameter in

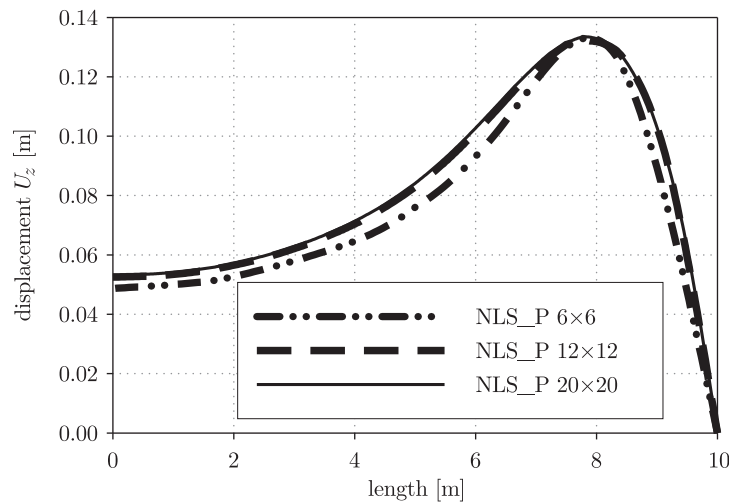

Figure 5. Convergence analysis of FE mesh – vertical displacement along X axis

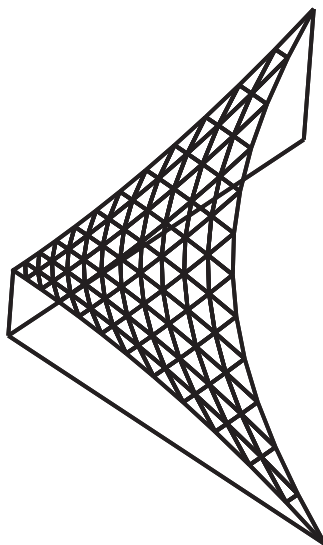

Figure 6. FE mesh

Figure 5 is taken first along the  $Y$  axis to the middle point of the roof. The length parameter is calculated as a polyline with two nodes:  $(0;0)$ ,  $(20;0)$ .

## 5. Numerical analysis

A self-made FEM code for a textile membrane analysis was used in the numerical calculations. An exact theoretical description, the FEM coding details and the application limits of this code are discussed in [21].

Comparisons of the vertical displacement in Figure 7 are made. In the next figures (see Figures 8 and 9) the stress isolines for the membrane roof subjected

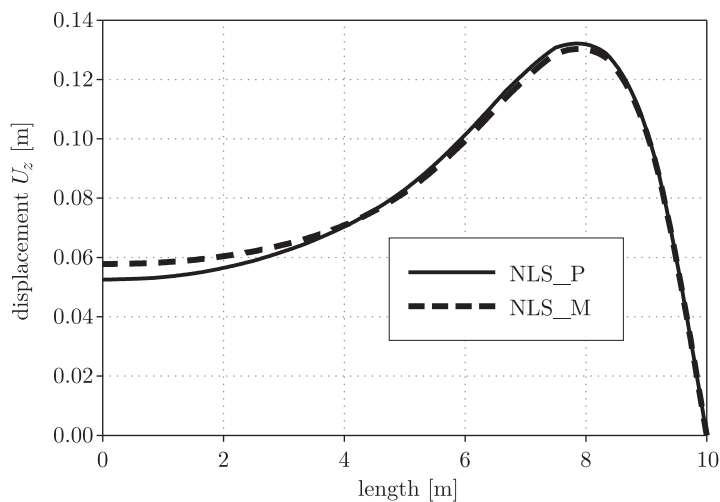
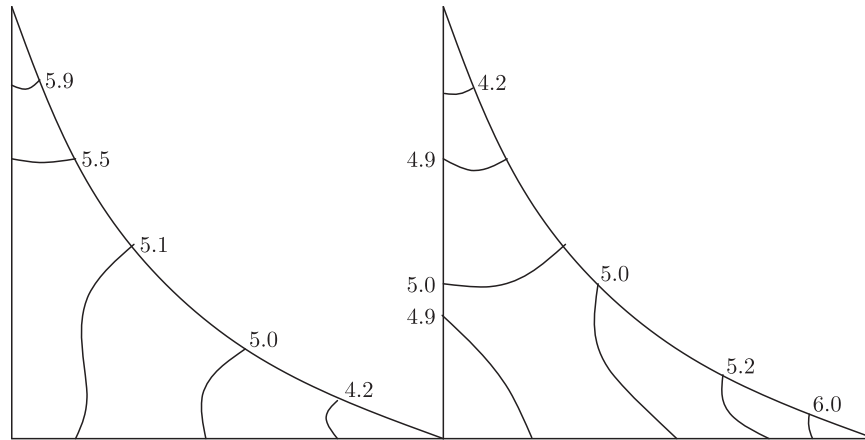
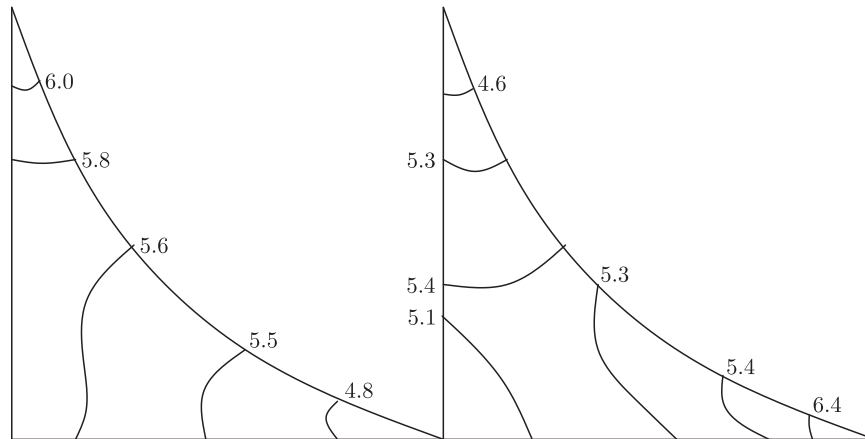

Figure 7. Vertical displacement along  $X$  axis





**Figure 8.** Distribution of stresses (left  $T_1$  kN/m, right  $T_2$  kN/m) – NLS\_P



**Figure 9.** Distribution of stresses (left  $T_1$  kN/m, right  $T_2$  kN/m) – NLS\_M

to the dead load and initial pretension forces are shown. The displacement profiles and membrane stress isolines obtained for the piecewise stress-strain and Murnaghan model relations are comparable.

## 6. Conclusions and general remarks

A geometrically non-linear analysis of a hyperbolic paraboloid TFS with non-linear elastic physical equations for a dense net model was successfully carried out. Calculations for a typical polyester base fabric coated by PVC were performed. Both the piecewise and Murnaghan model gave almost the same response in the calculated FE variants. The numerical results showed that the simplified piecewise model gave comparable results with a more advanced Murnaghan model.

The obtained results require revision for more complex roof shapes, analysis types and load kinds. The difference between material models is expected to grow when operational static loading or dynamic wind loads are applied. The



authors are aware that many other material models exist, but their engineering applications are limited due to the difficulties with identification of a large number of material parameters.

### **Acknowledgements**

The calculations presented in the paper were made at the Academic Computer Centre in Gdańsk (TASK).

### **References**

- [1] Stubbs N and Fluss H 1980 *Applied Mathematical Modelling* **4** (1) 51
- [2] Stubbs N and Thomas S 1984 *Mechanics of Materials* **3** (2) 157
- [3] Argyris J, Doltsinis J St and Silva V D 1991 *Comput. Meth. in Appl. Mech. and Engng* **88** 135
- [4] Argyris J, Doltsinis J St and Silva V D 1992 *Comput. Meth. in Appl. Mech. and Engng* **98** 159
- [5] Kato S, Yoshino T and Minami H 1999 *Engineering Structures* **21** 691
- [6] Kuwazuru O and Yoshikawa N 2002 *The 5<sup>th</sup> World Congress on Computational Mechanics*, Vienna, Austria, pp. 1–10
- [7] Xue P, Peng X and Cao J 2003 *Composites Part A* **34** 183
- [8] King M J, Jearanaisilawong P and Socrate S 2005 *Int. J. Solids and Structures* **42** (13) 3867
- [9] Pargana J B, Lloyd-Smith D and Izzuddin B A 2007 *Engineering Structures* **29** (7) 1323
- [10] Galliot C and Luchsinger R H 2009 *Composite Structures* **90** 438
- [11] Branicki Cz and Kłosowski P 1983 *Archives of Civil Engineering* **29** 189 (in Polish)
- [12] Branicki Cz 1969 *Some Static Problems of Hanging Nets*, PhD Thesis, Gdańsk University of Technology, Poland (in Polish)
- [13] Ambroziak A 2006 *TASK Quart.* **10** (3) 253
- [14] Ambroziak A 2005 *TASK Quart.* **9** (2) 167
- [15] Kłosowski P, Komar W and Woźnica K 2009 *Construction and Building Materials* **23** (2) 1133
- [16] Bejan L and Poterasu V F 1999 *Comput. Meth. in Appl. Mech. and Engng* **179** 53
- [17] Armijos S J 2008 *Fabric Architecture: Creative Resources for Shade, Signage, and Shelter*, W. W. Norton & Company, Inc.
- [18] Otto F 2001 *Tensile Structures*, MIT Press, New York
- [19] Лурье А И 1970 Теория упругости, *Nauka*, Moscow, Russia (in Russian)
- [20] Stanuszek M 2003 *Finite Elements in Analysis and Design* **39** 599
- [21] Kłosowski P 1983 *Statics and Dynamics of Cable-Membrane Hanging Roofs in Materially and Geometrically Non-linear Approach*, PhD Thesis, Gdańsk University of Technology, Poland (in Polish)