

Experiment-aided virtual prototyping to minimize tool-workpiece vibration during boring of large-sized structures

Krzysztof J. Kaliński¹[0000-0003-1658-4605], Marek A. Galewski¹[1111-2222-3333-4444],
Michał R. Mazur¹[1111-2222-3333-4444], Natalia Morawska¹[0000-0002-6565-1977]

¹ Gdansk University of Technology, Gdansk, Poland
natalia.morawska@pg.edu.pl

Abstract. The paper presents the author's method of solving the problems of vibration suppression during boring of large-sized workpieces by means of an innovative method of adjusting the rotational speed of the boring bar. It consists in selecting the spindle speed in accordance with the results of the cutting process simulation. The method includes identification of the model of the finite element method of the boring bar. The Root Mean Square (RMS) values of the time plots and dominant values of the peaks in the frequency spectra were obtained during the boring process. The effectiveness of the proposed attempt is demonstrated by the selected mechatronic design technique, known as Experiment-Aided Virtual Prototyping (E-AVP). The proposed method has been verified based on the results of experimental research.

Keywords: boring, vibration surveillance, optimal spindle speed, experimental identification

1 Introduction

The main cause of various problems occurring during machining of large-sized structures are relative vibrations of the tool-workpiece [1]. Some of them include reduction of the overall machine tool performance or the quality of the machined surface, increased tool wear, especially in the case of boring [2]. In addition, in extreme cases destruction of the tool or workpiece is observed. In order to increase efficiency while maintaining the surface quality and minimizing the vibration level, appropriate production parameters should be adjusted.

The subject of the paper is a method of looking for conditions to minimize the level of vibration of the tool during the process of boring holes in large-sized workpieces [3].

2 Simulation model

The process of boring flexible large-sized structures/workpieces can be considered in the convention of a discrete system in hybrid coordinates [4]. Thus, in the appropriate machining process diagram (Fig. 1), it is possible to isolate:

- modal subsystem, i.e. stationary finite element (FE) model of a flexible workpiece moving at the feed speed v_f , supported on Elastic-Damping Elements (EDE) [5]. At the beginning, the subsystem has a large number of degrees of freedom. After the modal transformation, behaviour of the subsystem is described by means of the vector of its modal coordinates \mathbf{a} , the number of which is much smaller than the corresponding number of degrees of freedom;
- structural subsystem, i.e. non-stationary discrete model of rotating indexable tool with set spindle speed n (i.e. one flexible finite element, the Euler-Bernoulli Bar (E-BB) no. e , or more) and cutting process (i.e. Coupling Element (CE) no. l [6]). The behaviour of the structural subsystem is described by the vector of its generalised coordinates \mathbf{q} . The rake angle ν_0 and the clearance angle α_0 were determined as elements of edge geometry, as well as time-varying thickness $h_l(t)$ and width $b_D(t)$ of the machined layer;
- abstractive time variable position of the contact point S between the cutting tool and the workpiece. Its Cartesian coordinates are linked to the others by means of time-dependent constraint equations [6].

Finally, the dynamics equation of a non-stationary cutting process model in hybrid coordinates takes the form [4, 6]:

$$\begin{bmatrix} \mathbf{M} & \mathbf{0} \\ \mathbf{0} & \mathbf{I} \end{bmatrix} \underbrace{\begin{Bmatrix} \ddot{\mathbf{q}}_s \\ \ddot{\mathbf{a}}_m \end{Bmatrix}}_{\ddot{\boldsymbol{\xi}}} + \begin{bmatrix} \mathbf{L} & \mathbf{0} \\ \mathbf{0} & 2\mathbf{Z}\boldsymbol{\Omega} \end{bmatrix} \underbrace{\begin{Bmatrix} \dot{\mathbf{q}}_s \\ \dot{\mathbf{a}}_m \end{Bmatrix}}_{\dot{\boldsymbol{\xi}}} + \begin{bmatrix} \mathbf{K} + \sum_{l=1}^{i_l} \mathbf{T}_l^T(t) \mathbf{D}_{Pl}(t) \mathbf{T}_l(t) & - \sum_{l=1}^{i_l} \mathbf{T}_l^T(t) \mathbf{D}_{Pl}(t) \mathbf{W}_l(t) \\ - \sum_{l=1}^{i_l} \mathbf{W}_l^T(t) \mathbf{D}_{Pl}(t) \mathbf{T}_l(t) & \boldsymbol{\Omega}^2 + \sum_{l=1}^{i_l} \mathbf{W}_l^T(t) \mathbf{D}_{Pl}(t) \mathbf{W}_l(t) \end{bmatrix} \underbrace{\begin{Bmatrix} \mathbf{q}_s \\ \mathbf{a}_m \end{Bmatrix}}_{\boldsymbol{\xi}} = \begin{bmatrix} \sum_{l=1}^{i_l} \mathbf{T}_l^T(t) \mathbf{F}_l^0(t) \\ - \sum_{l=1}^{i_l} \mathbf{W}_l^T(t) \mathbf{F}_l^0(t) \end{bmatrix} + \begin{bmatrix} \sum_{l=1}^{i_l} \mathbf{T}_l^T(t) \mathbf{D}_{Ol}(t) \Delta \mathbf{w}(t - \tau_l) \\ - \sum_{l=1}^{i_l} \mathbf{W}_l^T(t) \mathbf{D}_{Ol}(t) \Delta \mathbf{w}(t - \tau_l) \end{bmatrix}, \quad (1)$$

where: \mathbf{M} , \mathbf{L} , \mathbf{K} – matrices of inertia, damping and stiffness structural subsystem, $\boldsymbol{\xi} = \begin{Bmatrix} \mathbf{q} \\ \mathbf{a} \end{Bmatrix}$ – vector of hybrid coordinates of the hybrid system, $\boldsymbol{\Omega}$ – matrix of angular natural frequencies of the modal subsystem (the stiffness modal matrix); \mathbf{Z} – matrix of dimensionless damping coefficients (the modal damping) of the modal subsystem; i_l – number of „active” coupling elements.

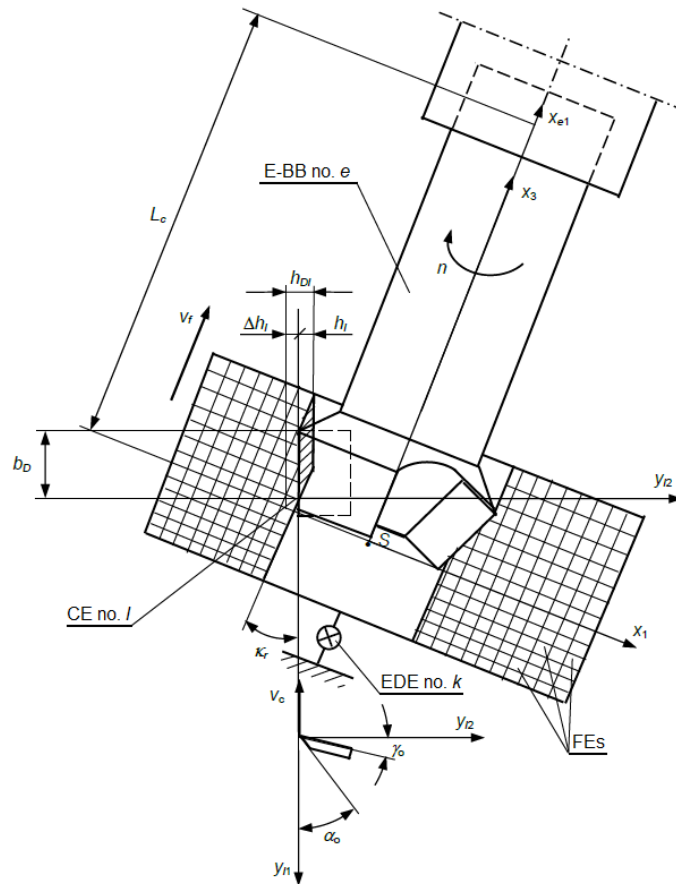

Fig. 1. The hybrid model of a boring process

3 Optimization of spindle speed during boring of large-sized structures using Experiment-Aided Virtual Prototyping (E-AVP)

The proposed method of surveillance consists in determining the optimal rotational speed of the tool based on the simulation of the machining process, carried out for the calculation model of a rotating tool tuned to the results of modal tests, along with the adopted cutting process model.

The first stage of the procedure is the validation of the parameters of the discrete MES model of the boring bar with the results of the modal identification of the actual test facility. This applies in particular to the frequencies of the dominant normal modes, dimensionless damping coefficients ζ and vibration vector Ψ . After adjusting the pa-

rameters of the discrete boring model, a hybrid model of the machining process is created. The next step in this procedure is to estimate the cutting process parameters, i.e. the average dynamic specific cutting pressure k_{dl} and the coefficients of cutting forces μ_2 and μ_3 . After adjusting the machining parameters, the allowed range of the spindle speed to be tested is selected, and machining simulations are performed for the selected speeds in this range. After their completion, the spindle speed is selected as the optimal one for which the lowest vibration level or the lowest dominant amplitudes in the spectra has been reached.

The scheme of the modal procedure of spindle speed optimization during boring of large-sized structures by Experiment-Aided Virtual Prototyping (E-AVP) is shown in Fig. 2. According to this procedure, the hybrid model of the boring process (Fig. 1) has been modified, namely:

- the workpiece mounted on the machine table is assumed to be perfectly rigid, whereas the rotating tool's flexibility (so-called boring bar) is taken into account;
- no MAC criterion [6] was used to assess the compatibility of the boring calculation model with the real object. The above results from the modelling method with the use of finite elements of the "Euler-Bernoulli type" bar, where the positions of nodes do not correspond to the locations of accelerometers;
- while creating the calculation model of the boring process, the compliance of the simulated RMS values with those obtained during the measurements was not checked. The latter resulted from the impossibility of obtaining reliable data on the basis of available measuring equipment during the implementation of the machining process. Hence, the values of the hybrid model required for simulation are estimated using the so-called the "mechatronic" procedure [7].

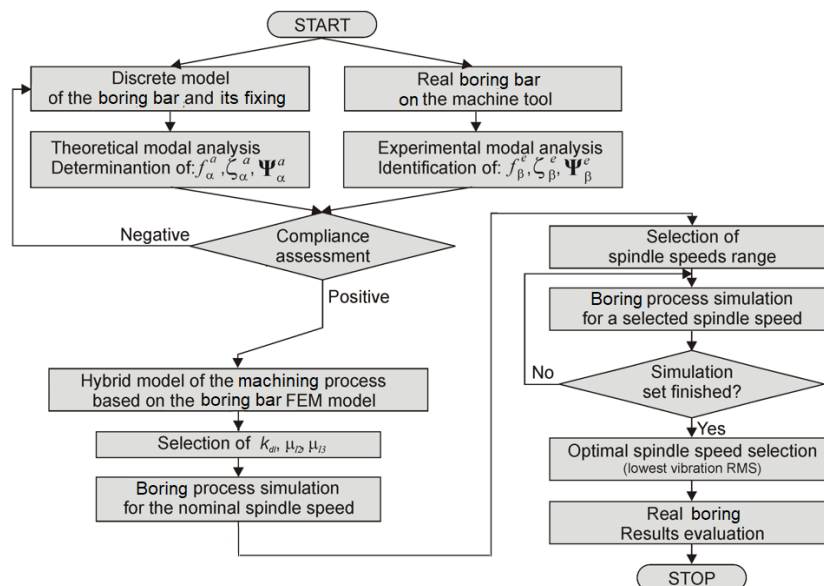

Fig. 2. Scheme of optimization of the spindle speed in the process of boring large-sized workpieces using E-AVP

The essence of the proposed method is identification of boring model parameters (before processing), computer simulation for a finite spindle speed set and implementation of the machining process (for previous simulation results).

4 Research object

Experimental research was carried out on a WHN 13-15 CNC by TOS VARNSDORF table milling and boring machine, working in PHS HYDROTOR S.A. in Tuchola. The boring of the bore hole with a final diameter of 737,5 mm in the DMS 4440 part was tested using a Sandvik CoroBore® 825 XL boring bar (Fig. 3). The treatment was first considered in accordance with the technology used in PHS HYDROTOR S.A., and then the results obtained were compared with the novel method. The workshop programming technique was used in the Sinumerik 840D controller.

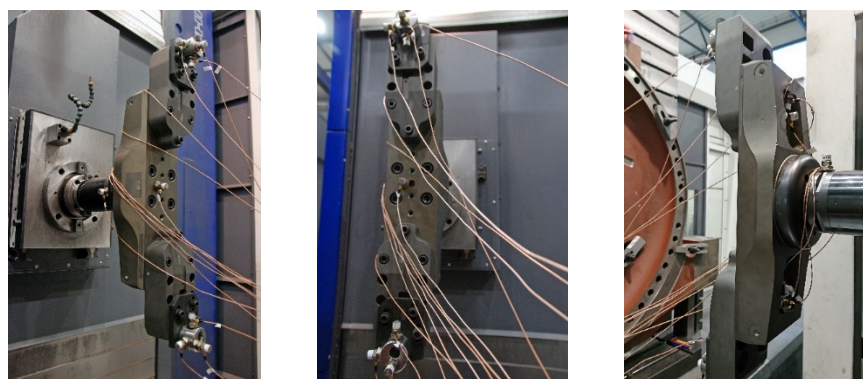

Fig. 3. Boring bar views of with attached accelerometers in the minimum spindle extension position

4.1 Modal identification of boring bar

To verify and adjust the parameters of the MES model of the boring bar, its modal parameters were identified in the position of the minimum spindle extension. Fig. 4 shows the location of accelerometers.

The modal research was carried out using a modal hammer with a standard tip. The response of the tested object was recorded using 15 DJB accelerometers (Akt17 – Akt31) with a measuring range of ± 75 g.

The scope of research included:

- 2 times for 4 set of 40 strokes in the direction of accelerometers Akt18, 21, 22, 29;
- 60 strokes (additional series) towards the Akt21 accelerometer.

The FRF values were determined using the H3 estimator. An example of the FRF function is shown in Fig. 5. The ERA method [5, 8] and the p-LSCFD method [5, 9] were used to identify the parameters of the modal model of the boring bar.

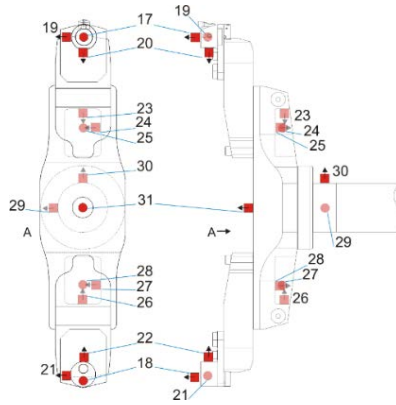

Fig. 4. Scheme of the Sandvik CoroBore 825 XL boring bar with marked accelerometers positions

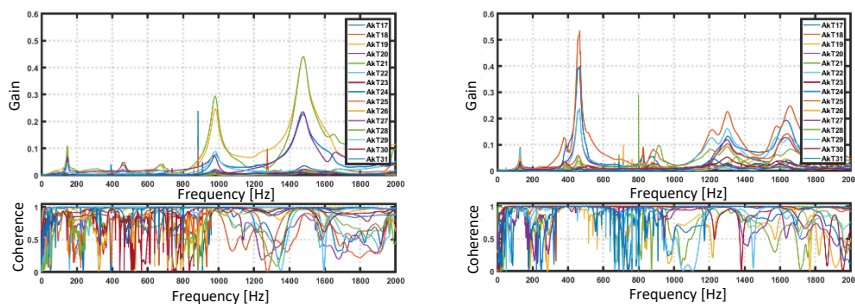

Fig. 5. Exemplary FRF acceleration of the boring bar

4.2 The calculation model of a boring bar

Based on the characteristic geometrical dimensions of the CoroBore® 825 XL boring bar, the MES model was created containing 4 2-node finite elements of the “Euler-Bernoulli bar” (E-BB) type, connected by means of Elastic-Damping Elements (EDE) [5, 6]. The computational model has a total of 8 nodes, and each of them has 6 degrees of freedom, so the total number of degrees of freedom is 42 (Fig. 6).

5 Simulations results

Selected results of the boring process simulation for 5 different values of technological parameters are summarized in Tab. 1. Spindle speed n in the range from 105 to 125 rpm and feed speed v_f in the range from 9,6 to 11,4 mm/min. Amplitude spectra were determined for a given moment of their observation t_p .

The average simulation time takes about 30% of the main machining time.

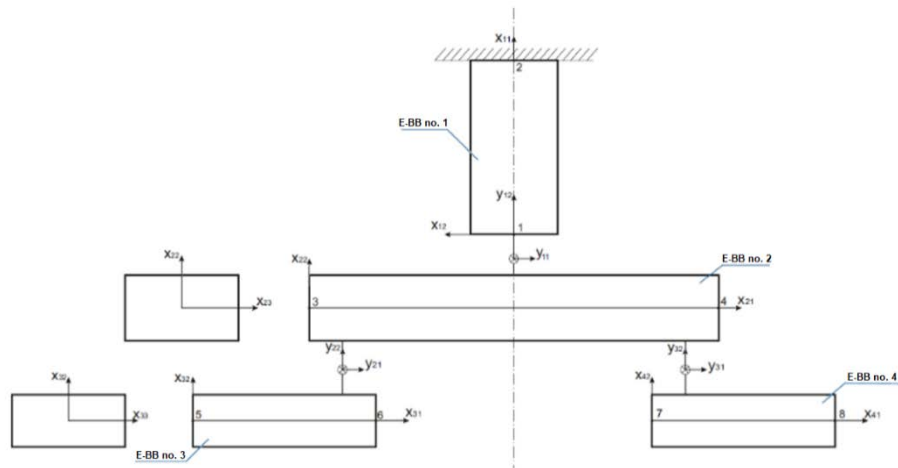

Fig. 6. The computational model of boring bar in the MES convention, including „Euler-Bernoulli bar” (E-BB) and Elastic-Damping Elements (EDE)

Table 1. The RMS values of vibrations displacements and dominant “peaks” of amplitudes in spectra. Underlined value – optimal results; bold value - adverse results

n [rpm]	v_f [mm/min]	max [mm]	RMS [mm]	t_{p1} [s]	f [Hz]	q [mm]	t_{p2} [s]	f [Hz]	q [mm]
105	9,6	0,031	0,0072	30	1,762	0,00055	300	1,762	0,0005
					126,050	0,00002		127,291	0,0082
110	10,1	0,039	0,0084		1,846	0,00055		1,846	0,0005
					126,054	0,00001		126,305	0,0112
115	10,5	0,031	<u>0,0056</u>					127,648	0,0014
					1,930	0,00055		1,930	0,0005
					125,732	0,00002		126,302	0,0014
								127,793	0,0055
<u>120</u>	11	<u>0,024</u>	0,0065		2,014	0,00055		2,014	0,0006
					126,851	0,00002		127,446	<u>0,0068</u>
125	11,4	0,04	0,0107		2,097	0,00055		2,097	0,0006
					125,796	0,00002		126,750	0,0118

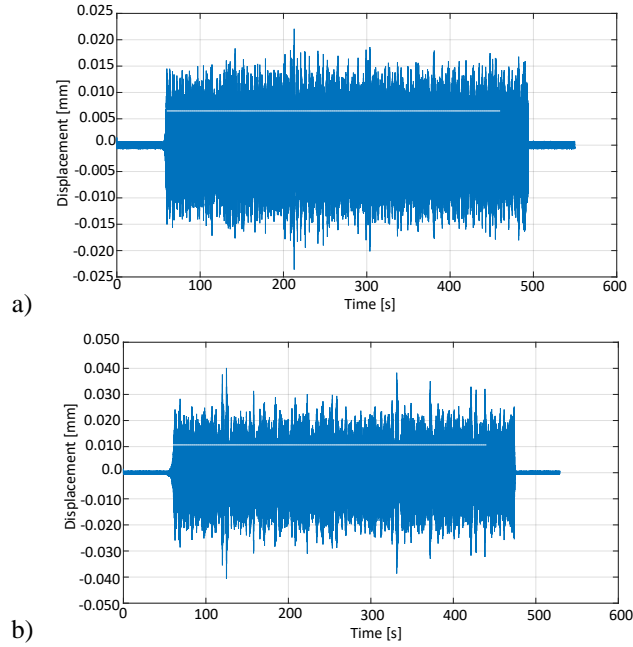

Fig. 7. Simulated vibrations in time domain: a) optimal spindle speed $n = 120$ rpm, b) adverse spindle speed $n = 125$ rpm

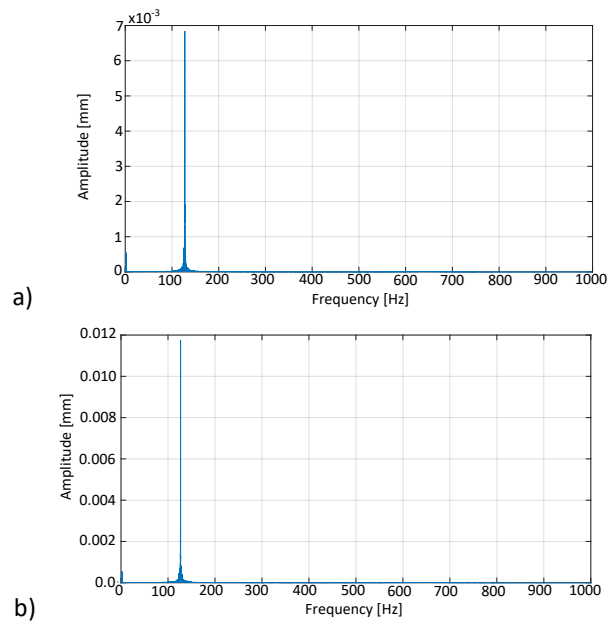

Fig. 8. Amplitude spectra observed at time $t_p = 300$ s: a) optimal spindle speed $n = 120$ rpm, b) adverse spindle speed $n = 125$ rpm

6 Implementation of the boring process

To confirm the accuracy of predictions obtained as a result of simulation, the hole boring process was carried out in part DMS 4440 on a CNC machine WHN 13-15 using a CoroBore® 825 XL boring bar. Data regarding individual machining processes/operations and their results are presented in Tab. 2. The basis for the assessment was the local measurement of the roughness parameters Ra and Rz of the hole surface in the lowest place (Fig. 9). The workshop programming technique was used in the Si-mumerik 840D controller.

In comparison to the HYDROTOR technology, the vibration level decreased significantly (Tab. 1). The maximum displacement value has been reduced by 23%, and the dominant amplitude in spectra by 17%. The above was accompanied by the increase of the spindle speed from 105 to 120 rpm (i.e. 14%) which shortened the main machining time by 0,89 min (11%). The measured values of Ra and Rz parameters have changed slightly (Tab. 2), which confirm that the requirements for maintaining the surface quality have been met, even with increased machining efficiency. Although the results of the simulation did not confirm this, further spindle speed increase to 125 rpm (about 19%) and simultaneous shortening of the main time by 1,55 mm (19%) results in a radical reduction of the roughness parameters. The above arguments show the benefits of the proposed method.

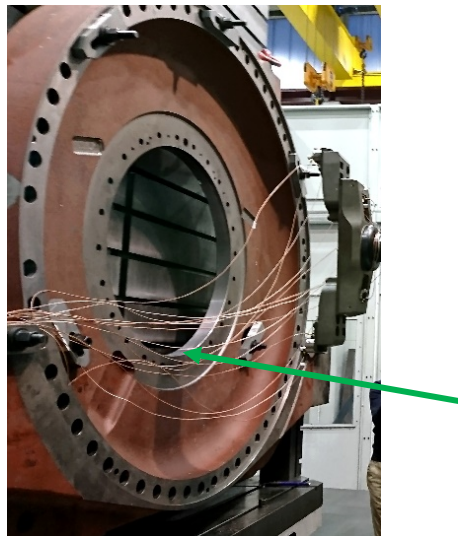

Fig. 9. View of element no. 440 with the roughness point marked

7 Conclusions

Thanks to the results and the implementation of the task, the effectiveness of vibration suppression of the “tool-workpiece” has been confirmed by optimizing the spindle

speed during the boring of large-sized structures using the Experiment-Aided Virtual Prototyping (E-AVP) technique.

Table 2. Parameters and results of boring element no. DMS 4440

Cut	a_p [mm]	n [rpm]	v_f [mm/min]	D [mm]	Ra [μm]	Rz [μm]	Technology
W0		105	9,6	724,47			Initial cut
W1	0,5	105	9,6	725,4613	1,734	10,09	
W2	1	105	9,6	727,4632	5,080	24,73	PHS HYDROTOR S.A.
W3	1	110	10,1	729,4516	4,063	19,93	GUT
W4	1	120	10,8	731,4521	5,852	26,53	GUT
W5	1	125	11,9	733,4432	3,935	20,09	GUT
W6	2	105	9,6	737,5041	5,542	24,76	GUT

Acknowledgments

The research was carried out as part of tasks financed under the TANGO1/266350/NCBR/2015 project. Experimental investigations on the WHN 13-15 CNC boring machine were made thanks to cooperation with PHS HYDROTOR S.A. in Tuchola.

References

1. Ajayan, M., Nishad, P. N.: Vibration control of 3D gantry crane with precise positioning in two dimensions. In: Annual International Conference on 24-26 July 2014, pp. 1–5. IEEE Emerging Research Areas: Magnetics, Machines and Drives (AICERA/iCMMD) (2014).
2. Yigit, U., Cigeroglu, E., Budak, E.: Chatter reduction in boring process by using piezoelectric shunt damping with experimental verification. *Mechanical Systems and Signal Processing* 94, 312-321 (2017)
3. Uriarte, L., Zatarain, M., Axinte, D., et al.: Machine tools for large parts. *CIRP Annals-Manufacturing Technology* 62(2), 731-750 (2013).
4. Kaliński, K. J., Galewski, M. A.: Optimal spindle speed determination for vibration reduction during ball-end milling of flexible details. *International Journal of Machine Tools and Manufacture* 92, 19-30 (2015).
5. Kruszewski, J., Gawroński, W., Wittbrodt, E., Najbar, F., Grabowski, S.: *Rigid Finite Elements Method*. Arkady, Warszawa (1975) (in Polish).
6. Kaliński, K. J.: *A surveillance of dynamic processes in mechanical systems*. The GUT Publishing House, Gdańsk (2012) (in Polish).
7. Galewski, M., Kaliński, K.: *Vibration Surveillance at slender high speed milling with the use of changing spindle speed*. The GUT Publishing House, Gdańsk (2009) (in Polish).
8. Maia, N. M. M., Silva, J.M.M.: *Theoretical and Experimental Modal Analysis*. Taunton, Somerset (England): Research Studies Press (1997).
9. Heylen W., Lammens S., Sas P.: *Modal Analysis Theory and Testing*. KU Leuven (2007).