

JAN A. SZANTYR, Prof., D.Sc., N.A.
 Technical University of Gdańsk
 Faculty of Ocean Engineering
 and Ship Technology
 Department of Ship Hydromechanics

Experimental measurements of the hydrodynamic characteristics of the pod propulsor models

SUMMARY

The article presents results of measurements of the overall hydrodynamic characteristics of the three variants of a generic pod propulsor model. The measurements were conducted in the cavitation tunnel of the Faculty of Ocean Engineering and Ship Technology, Technical University of Gdańsk. A special model of a pod propulsor was constructed, enabling measurements of thrust, side force and moment around the vertical axis on the entire propulsor. The measurements were conducted for three variants of the propulsor configuration and for a wide range of operational parameters. The results are presented in the form of standard non-dimensional coefficients in the function of advance coefficient and drift angle.

INTRODUCTION

Pod propellers are becoming more and more popular propulsors for certain classes of ships. Units of several thousands kilowatts of absorbed power are being applied in full scale [4]. At the same time available knowledge about different aspects of their hydrodynamic and structural performance still lags behind the zest for high power full scale application. Many research centres all over the world conduct experimental and theoretical research on pod propulsors, but the results are seldom published in a form suitable for analysis and comparison. Experimental results presented in this article are the result of a research project conducted at the Faculty of Ocean Engineering and Ship Technology, Technical University of Gdańsk for the last two years. The main target of this project is the development of a numerical procedure for hydrodynamic analysis of pod propulsors [6]. The experimental part of the project was intended to provide reliable data for verification of the numerical procedure and also to serve as inspiration in development of certain important details of the computational model of such a propulsor [2,3]. A very extensive program of measurements was conceived, covering three different configurations of the propulsor and a wide range of operational parameters. The results are presented in the following sections of this article.

DESCRIPTION OF THE EXPERIMENTAL STAND

The experiments with pod propulsor were conducted in the cavitation tunnel of the Faculty of Ocean Engineering and Ship Technology. This tunnel is a medium size experimental facility built in the 1970s and its main data are as follows :

length between vertical axes	8.15	[m]
height between horizontal axes	5.50	[m]
length of the measuring section	2.20	[m]
cross-section of the measuring section	0.5x0.5	[m]
volume of water	24.0	[m ³]
maximum flow velocity	12.0	[m/s]
range of static pressure	20±2000	[hPa]

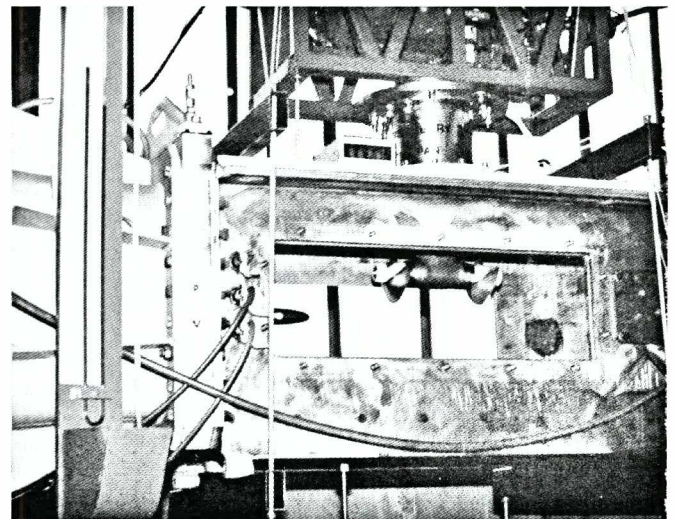

Fig.1. View of the experimental stand installed on top of the cavitation tunnel

The specially designed and built experimental stand is mounted on top of the measuring section, as shown in Fig.1.

The main part of the stand was the three-component tensometric dynamometer enabling the measurement of two force components in horizontal plane and one moment component around the vertical axis (Fig.2). The propulsor model was suspended from the dynamometer and placed in the measuring section of the tunnel. The dynamometer together with the model could be rotated around the vertical axis by a prescribed drift angle β . The model was propelled by an electrical motor, mounted above the dynamometer, through a toothed-belt transmission.

The following quantities were measured during the experiments :

- velocity of flow in the measuring section V [m/s]
- rotational speed of the propulsor shaft n [rev/s]
- total axial hydrodynamic force F_x [N]
- total transverse hydrodynamic force F_y [N]
- total hydrodynamic moment around the vertical axis M_z [Nm]

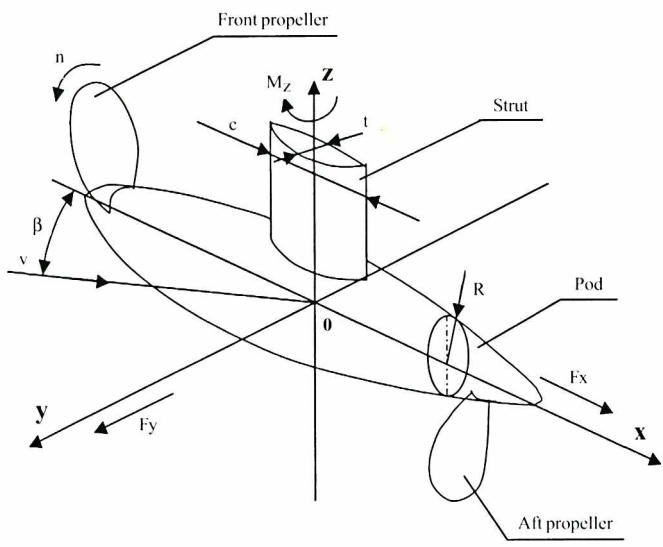

Fig.2. Scheme of the parameters measured during the experiments
Notice : β - drift angle

DESCRIPTION OF THE PROPULSOR MODEL

The specially designed and built propulsor model had a steel skeleton covered by an external shell made of GRP. The main geometrical characteristics of the model are shown in Fig.3.

The propellers installed in the pod model, designed on the basis of the Gawn propeller series (for more details see [1]) had the following main geometrical characteristics :

- propeller diameter (both propellers) $D = 0.182$ [m]
- hub diameter $d = 0.064$ [m]
- number of blades $z = 3$
- expanded blade area ratio $A/A_0 = 0.8$
- pitch of the pulling propeller (radially constant) $P/D = 0.8$
- pitch of the pushing propeller (radially constant) $P/D = 1.108$
- direction of rotation left

As it may be seen from Fig.3 and from the above data, the tested pod model had the geometry typical rather for high speed units than for pods currently installed in full scale cargo/passenger ships. This is because the experiments were intended to supply data for verification of the computational method, not to reproduce characteristics of an existing propulsor. The computations could be performed for a propulsor of arbitrary geometry.

RESULTS OF MEASUREMENTS FOR TWIN SCREW PROPULSOR

The measurements were performed for five values of propeller revolutions $n=15.0, 16.66, 18.33, 20.0$ and 21.66 rev/s. The velocity of flow in the tunnel was adjusted to produce advance coefficients J covering the range from 0.5 to 0.8 for each number of revolutions held constant. The drift angles β were changed from -15 to $+15$ degrees with interval of 2.5 degrees. In the case of the twin propeller pod two values of the phase angle between the pulling and pushing propeller were tested: $\phi = 0$ and $\phi = 60$ degrees. The results of measurements are presented in the form of the standard non-dimensional coefficients :

Advance coefficient	X-axis force coefficient
$J = \frac{V}{nD}$	$K_x = \frac{F_x}{\rho n^2 D^4}$
Y-axis force coefficient	Moment coefficient
$K_y = \frac{F_y}{\rho n^2 D^4}$	$K_m = \frac{M_z}{\rho n^2 D^5}$

The figures 4 to 9 present the results of measurements for twin propeller pod at zero and maximum positive and negative drift angles, combined with both tested values of the phase angles. The measurement results have not been faired because they may reflect certain specific physical phenomena, characteristic for pod propulsor hydrodynamics, which could be lost during an indiscriminate fairing.

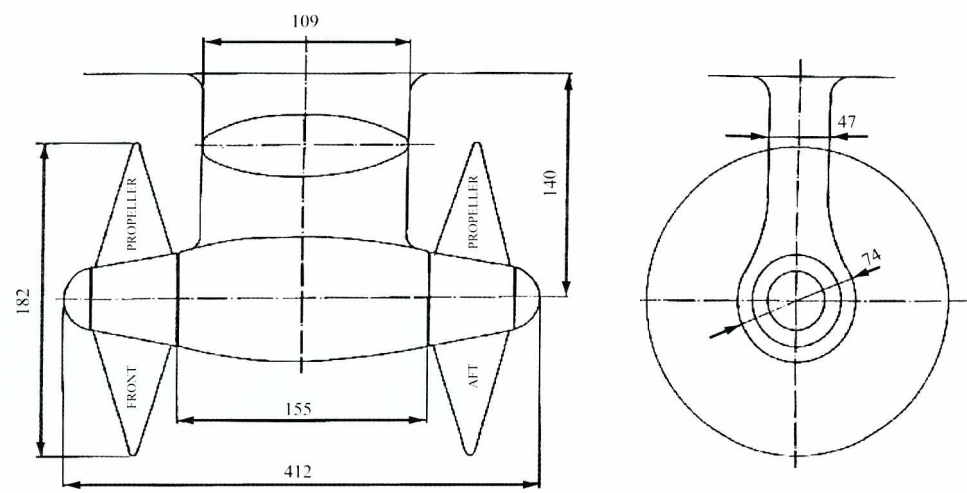

Fig.3. Sketch of the pod propulsor model

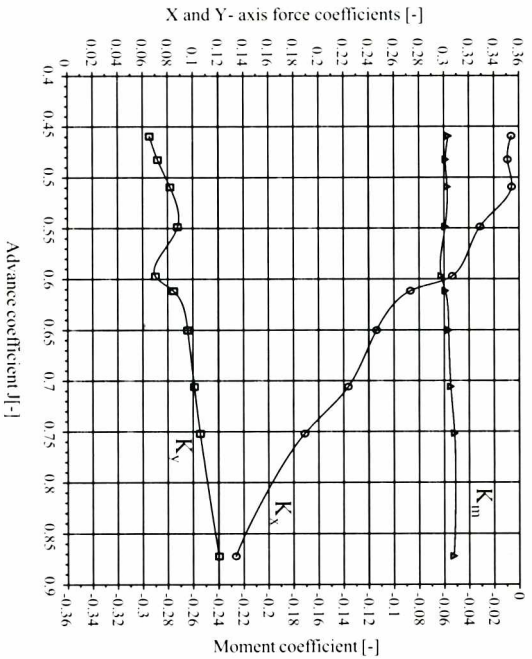

Fig. 4. Hydrodynamic characteristics of the twin propeller pod at $\beta = -15$ degrees and $\varphi = 60$ degrees

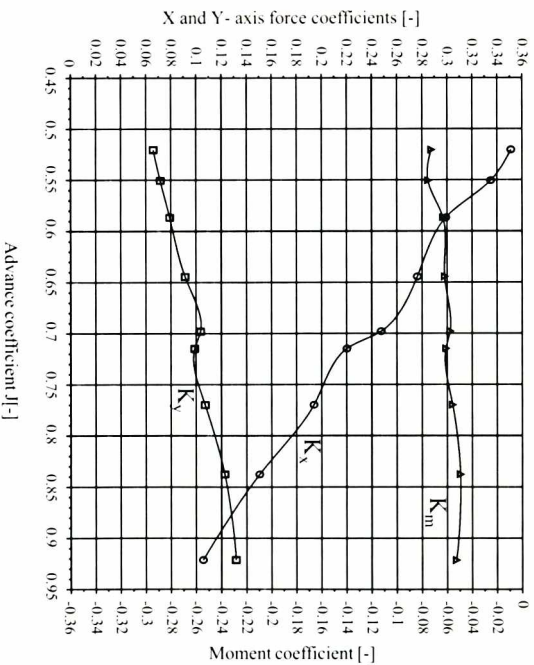

Fig. 7. Hydrodynamic characteristics of the twin propeller pod at $\beta = -15$ degrees and $\varphi = 0$ degrees

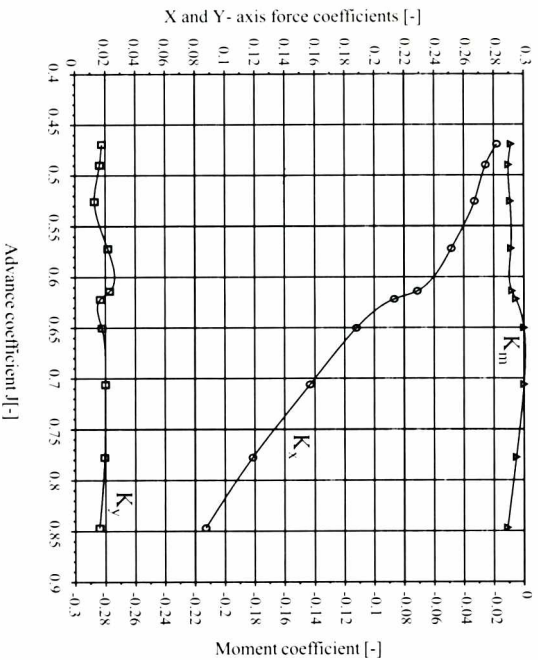

Fig. 5. Hydrodynamic characteristics of the twin propeller pod at $\beta = 0$ degrees and $\varphi = 60$ degrees

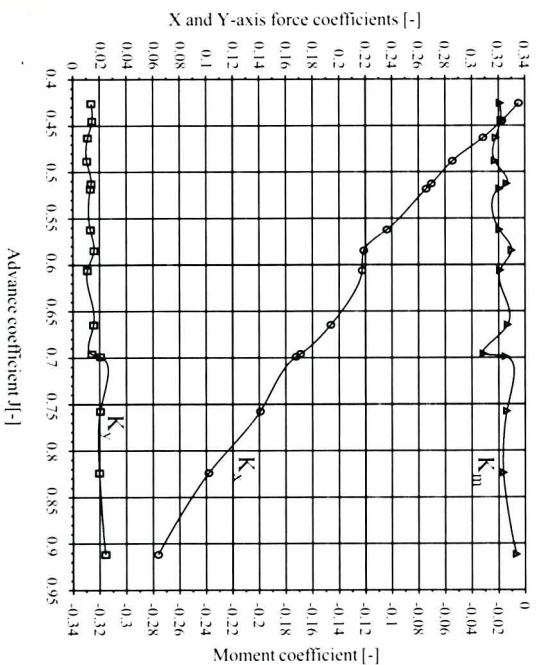

Fig. 8. Hydrodynamic characteristics of the twin propeller pod at $\beta = 0$ degrees and $\varphi = 0$ degrees

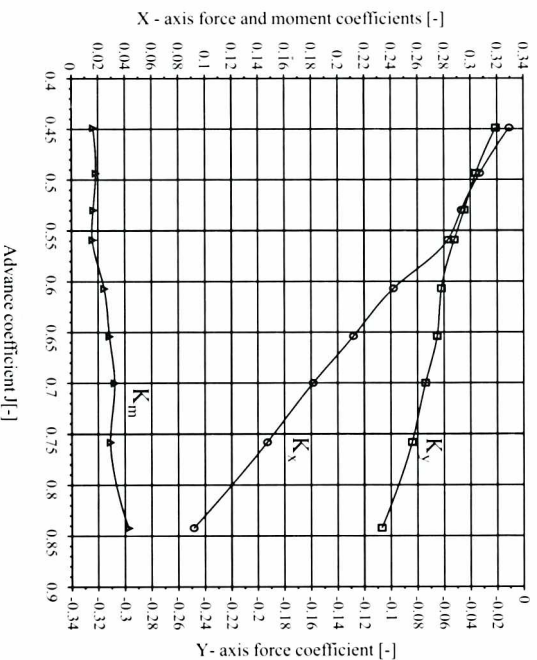

Fig. 6. Hydrodynamic characteristics of the twin propeller pod at $\beta = +15$ degrees and $\varphi = 60$ degrees

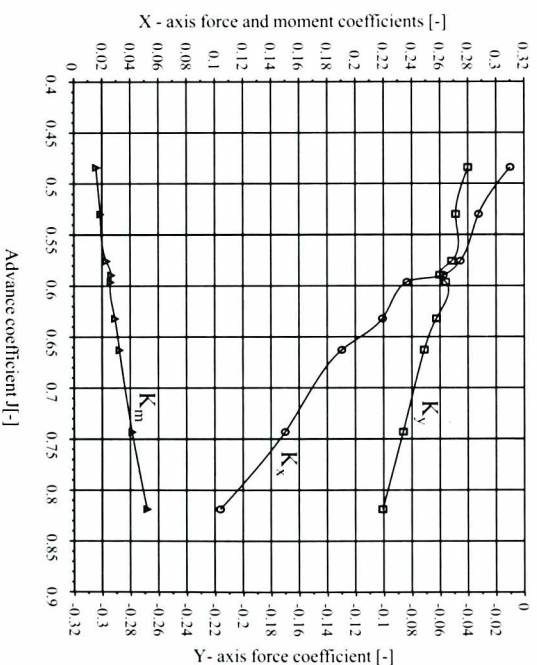

Fig. 9. Hydrodynamic characteristics of the twin propeller pod at $\beta = +15$ degrees and $\varphi = 0$ degrees



RESULTS OF MEASUREMENTS FOR SINGLE PULLING PROPELLER

The results of measurements for the pod with single pulling propeller are presented in the following three figures in the format identical to the results for the twin propeller pod.

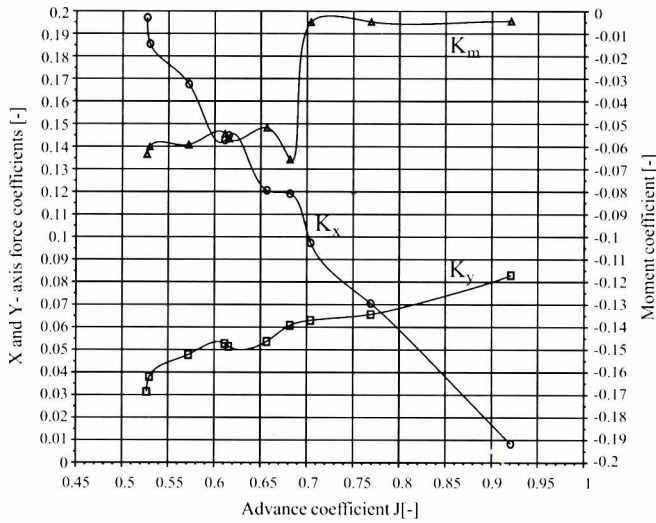

Fig. 10. Hydrodynamic characteristics of the pod with single pulling propeller at $\beta = -15$ degrees

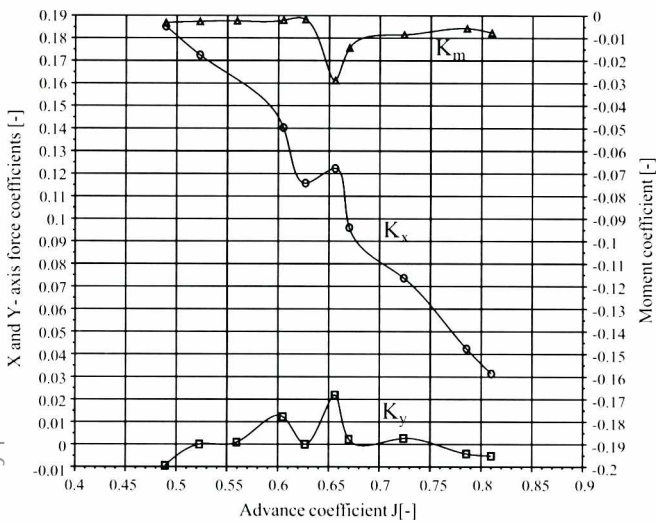

Fig. 11. Hydrodynamic characteristics of the pod with single pulling propeller at $\beta = 0$ degrees

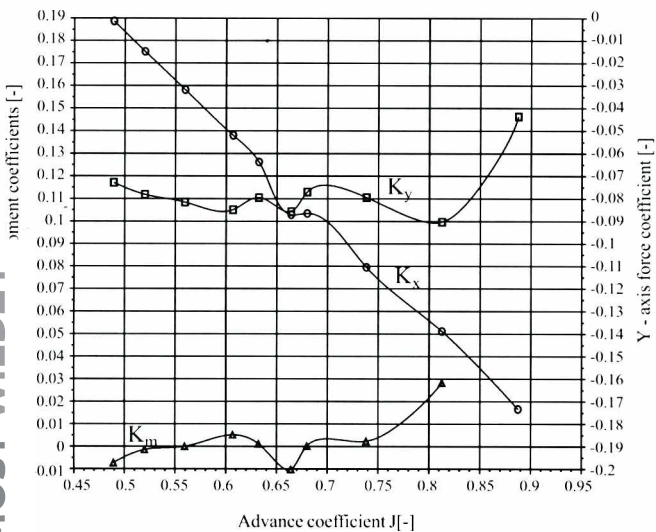

Fig. 12. Hydrodynamic characteristics of the pod with single pulling propeller at $\beta = +15$ degrees

RESULTS OF MEASUREMENTS FOR SINGLE PUSHING PROPELLER

The results of measurements for the pod with single pushing propeller are presented in the following three figures in the format identical to the results for the twin propeller pod.

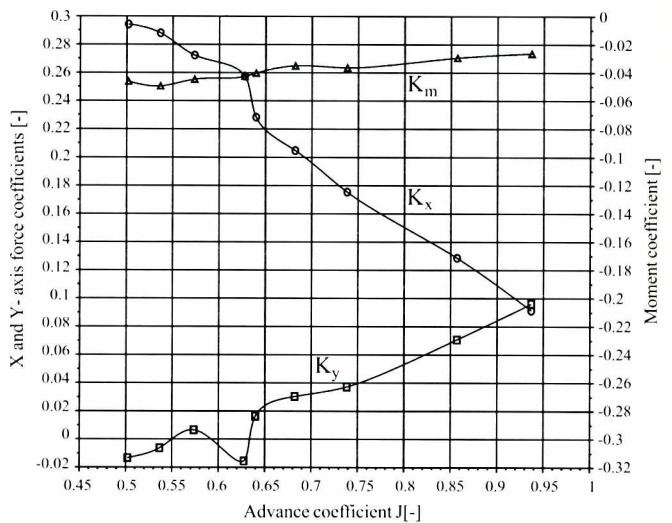

Fig. 13. Hydrodynamic characteristics of the pod with single pushing propeller at $\beta = -15$ degrees

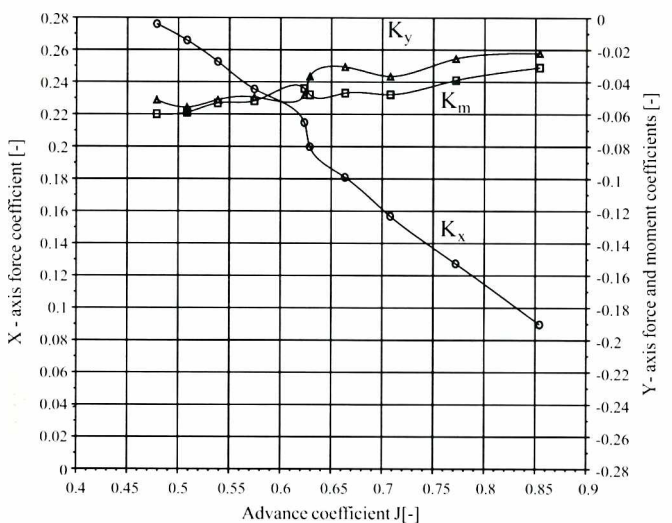

Fig. 14. Hydrodynamic characteristics of the pod with single pushing propeller at $\beta = 0$ degrees

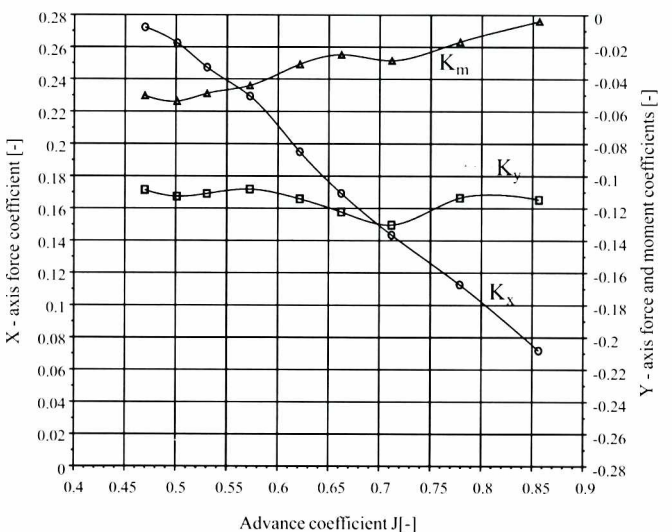

Fig. 15. Hydrodynamic characteristics of the pod with single pushing propeller at $\beta = +15$ degrees

CONCLUSIONS

The following conclusions may be drawn from the above presented results of experiments :

- Drift angle has a marked effect on the axial hydrodynamic force of the pod propulsor with two propellers and similar but smaller effect on the systems with single pulling propeller.
- Axial hydrodynamic force for moderate non-zero drift angles is higher than for $\beta = 0$.
- Direction of rotation has some effect on the change of the axial hydrodynamic force with changing drift angle: the force increases more for deflections in direction of propeller rotation.
- Changes of the transverse hydrodynamic force with drift angle also depend on the direction of propeller rotation, but in opposite sense: transverse force is higher for deflections directed against propeller rotation.
- In general hydrodynamic characteristics of a pod propulsor are asymmetrical with respect to the drift angle.
- This asymmetric effect is most visible for twin propeller configurations, slightly less visible for single pulling propeller and markedly less visible for single pushing propellers.
- In twin propeller configuration the interaction between front and aft propeller demonstrates itself by a wavy character of the axial force curve in function of the advance coefficient; location of the peaks and troughs of these waves depends on the phase shift angle between the propellers.

Acknowledgement

The research described in this paper has been financially supported by the Polish Committee for Scientific Research (KBN) .Grant No. 9T12C 026 17. The author would like to express his gratitude for this support. The author is also grateful to Mr. J. Koronowicz of the Institute of Fluid Flow Machinery in Gdańsk for design and construction of the propulsor model and to Mr. M. Grygorowicz of the Faculty of Ocean Engineering and Ship Technology, Technical University of Gdańsk, for preparation of the diagrams.

Appraised by **Tadeusz Koronowicz, Prof.,D.Sc.**

SYMBOLS AND ABBREVIATIONS

- A_0 - propeller expanded area ratio
- c - strut chord length
- C_p - propeller pitch coefficient
- r - local radius of the pod
- t - maximum thickness of the strut profile
- β - drift angle
- ρ - density of water
- δ - phase shift angle between front and aft propeller

BIBLIOGRAPHY

- on J.S.: *Marine Propellers & Propulsion*, Butterworth - Heinemann, Oxford.
- orowicz M.: *Cavitation Phenomena on the Pod Propulsor Model* (in Polish), Technical University of Gdańsk - Faculty of Ocean Engineering and Ship Technology, Report No. 2/2001/PB
- nowicz J. et al.: *Model Experiments with Pod Propulsor in the Cavitation* (in Polish), Technical University of Gdańsk - Faculty of Ocean Engineering and Ship Technology, Report No. 54/2000/PB
- ns P.: *Advances in Azimuthing Propulsion*, Diesel & Gas Turbine World, March 1993
- yr J.: *Concept and Scheme of the Pod Propulsor Model for Experimental* (in Polish), Technical University of Gdańsk - Faculty of Ocean Engineering and Ship Technology, Report No. 20/1999/PB
- yr J.: *Algorithm of the Computer Program for Hydrodynamic Analysis of Pod Propulsors* (in Polish), Technical University of Gdańsk - Faculty of Ocean Engineering and Ship Technology, Report No. 21/1999/PB

Conference



The 1st Summer School



The Faculty of Ocean Engineering and Ship Technology, Technical University of Gdańsk organized and hosted on 28 and 29 August the first Summer School on :

Safety at sea

intended to acquaint the participants with the problems of safety at sea and to present the applications of simulation as a tool to try to solve those problems with.

The list of subjects of those Schools comprises therefore the following problems :

- Design for safety, operation and research, safety management, safety systems, human factor
- Safety assessment methods
- Modelling of safety, i.e. identification of hazards and risk assessment, accident scenarios, risk assessment and methods of accident risk reduction, safety decision taking
- Safety computer simulations and their applications.

Program of the 1st Summer School comprised the following presentations :

- ♦ *The Formal Safety Assessment methodology and some of its applications* – by A. Brandowski, Technical University of Gdańsk
- ♦ *Determining the search zone for sea rescue operations in the Polish SAR zone of responsibility* – by Z. Bureciu, Gdynia Maritime Academy
- ♦ *Computer simulations of ship behaviour in rough seas as a tool used by the Gdańsk Ship Model Basin (CTO)* – by Jan Dudziak and P. Grzybowski, Ship Design and Research Centre, Gdańsk
- ♦ *Computer simulation of ship safety assessment in critical conditions* – by M. Gerigk, Technical University of Gdańsk
- ♦ *Safety of sea-going ships and shipping. Hydromechanical aspects* – by L. Kobylński, Foundation for Safety Navigation and Environment Protection, Gdańsk
- ♦ *The dislocation of superstructure, engine room and its casing as method of fire protection of ship* – by Agata Krystosik, Technical University of Szczecin
- ♦ *The choice of escape route as a decisive factor of the effectiveness of personnel evacuation in the ship fire conditions* by Dorota Łozowicka, Technical University of Szczecin
- ♦ *Dynamic structural analysis of a fishing vessel* – by M. Sa-las and R. Luco, University Austral of Chile
- ♦ *The Formal Safety Assessment applied to a selected ship type on the basis of hydromechanical characteristics in critical conditions* – by Monika Smajdor, Nauticus Modelling Centre, Gdańsk
- ♦ *Simulation of ship's trajectory planing by evolutionary computation* – by R. Śmierczalski, Gdynia Maritime Academy
- ♦ *Numerical approach to safety in intact condition during ship design* – by Jan Tellkamp, Flensburger Schiffbau Gesellschaft mbH, Germany
- ♦ *Analysis of the situation of a selected ship type and its initial stability before and after flooding of several watertight compartments* – by R. Wróbel and R. Szubartowski, Naval Academy, Gdynia.

The 1st Summer School was a part of activities of the Polish Society of Computer Simulation, and its co-organizers were: Academic Computer Centre in Gdańsk and McLeod Institute of Simulation Sciences.