

FATIGUE RESISTANCE INVESTIGATION OF THE IC ENGINE MB11 BEARINGS, WORKING UNDER CONDITIONS OF DYNAMIC UNIDIRECTIONAL LOADINGS

Jan Sikora, Jan Kłopocki, Wojciech Majewski

Gdańsk University of Technology
Mechanical Engineering Faculty
Narutowicza Street 11/12, 80-952 Gdańsk
tel.: +48 58 3471844, fax: +48 58 3472742
e-mail: jklopock@pg.gda.pl
jsikora@pg.gda.pl

Abstract

The slide bearing material MB11 fatigue resistance has been investigated with the application of SMOK - test stand in which dynamic unidirectional loadings to the test bearing is generated. Slide bearing layer consists of the bronze (Cu Pb22 Sn 3) sintered to the steel shell. Each of the tested bearing has been subject to the standard 20-hour test, under conditions of the full fluid lubrication. Methodology of the experiments, metallurgical test results and fractographic description of the lining fatigue crack zone are presented. The values of the fatigue strength parameters are also estimated. For the loading pattern that is characteristic for the test devices such as SMOK tester, because of the nominally negative high normal stresses in the damage area, the mechanisms of cracks generation could be explained as follows: yield stress can be reached when during compression at the bearing working temperature the local plastic deformation can appear. After completing the test, in the region of plastic deformation, the tensile stresses can be generated due to the temperature reduction. Slide material is much more sensitive to the tensile loadings than to the compressive one, especially in the area that is weakened by empty spaces. That might be reason for cracks generation. Additionally in the case of the thin-wall bearing shell, assembled in the elastic housing, the circumferentially oriented cracks can appear. It has been observed for high bearing loadings applied on the SMOK tester. Fatigue cracks in the MB11 material tested on the SMOK machine are of the surface net pattern, positioned paralleled to the slide surface (Fig. 8). Mainly structural cracks can be noticed when analyzing the metallographic description. This is related to the porosity of the alloy structure. This is much different from the aluminum alloy structure (the bearing alloy that was previously investigated) where arterial structures of cracks were dominant. The slide surface is the place of cracks nucleation. When in slide layer there are bigger soft material elements or voids it is also possible to observe generation of cracks in any place of the bulk thickness. During consequent development of the process the micro-cracks are spreading out and going to the next defected parts of the alloys. The continuous surface of separation is then developed. The micro-cracks space net which is typical for this kind of damage is not precisely oriented but rather random. The eventually oriented fracture is due to the not uniform structure.

Keywords: Transport, plain bearings, bearings testing, bearings fatigue, bearings fatigue

1. Introduction

The precise determination of the specific bearing material fatigue resistance parameters requires a lot of the experimental work with the application of the various laboratory devices allowing to simulate different work conditions of the IC engine bearing units. Among the most popular sliding layer materials of these bearings there are alloys composed of copper, lead, tin and small amount of the other additives.

The MB11 bearing material (CuPb22Sn3) [1] has been selected as a representative of medium strong alloys for fatigue resistance investigation within the frame of research project No. 7T07B 029 28.

2. Subject of investigation and the test arrangement

The shape and dimensions of the standard half-bearing are presented in the Fig. 1a. To adopt

this bearing to test requirement the standard bearing is modified by under-cutting the slide bearing layer at both edges to make the working slide surface smaller. The thickness of the bearing shell is measured in three sections (A, B and C - Fig. 1b). The two half-bearings are selected to form together full bearing (360°) when the mean values of their thicknesses are the same. In addition, the preliminary selection is made observing the same circumferential outer length of both half-bearings as well as their spread R (Fig. 1b) - measured before and after tests.

Test parameters

Investigations of the fatigue strength of the MB11 bearing have been performed on the dynamic loading tester SMOK [2] under the following conditions:

- rotational speed of the shaft is equal $n = 3000$ rpm,
- basis of the fatigue test is equal 3.6×10^6 loading cycles which means the duration of the test $t = 20$ hours,
- lubricant inlet pressure $p_{0l} = 5 \times 10^5$ [N/m²],
- selectol SAE 20W/30 oil is used as a tested bearing lubricant.

During the test the following parameters were measured and recorded: dynamic loading force, the tested bearing temperature, the temperature and lubricant pressure at the inlet to the bearing, ambient temperatures of the bearing.

a)

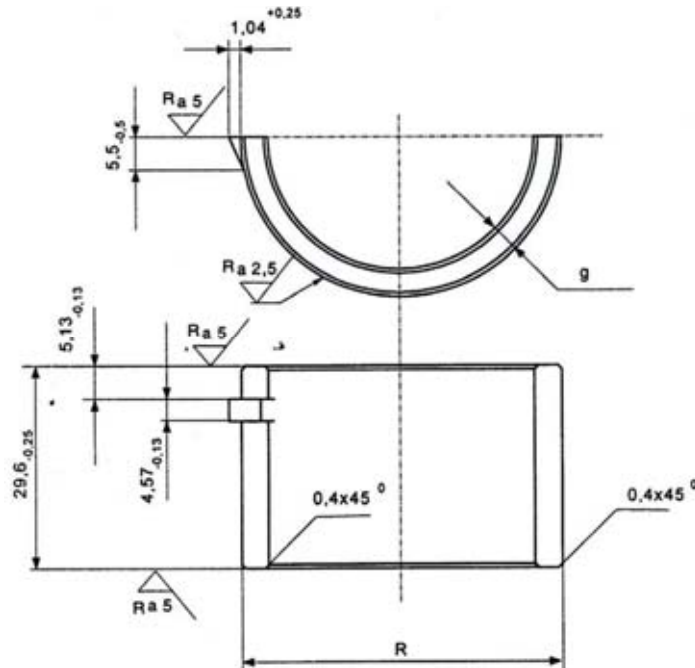

b)

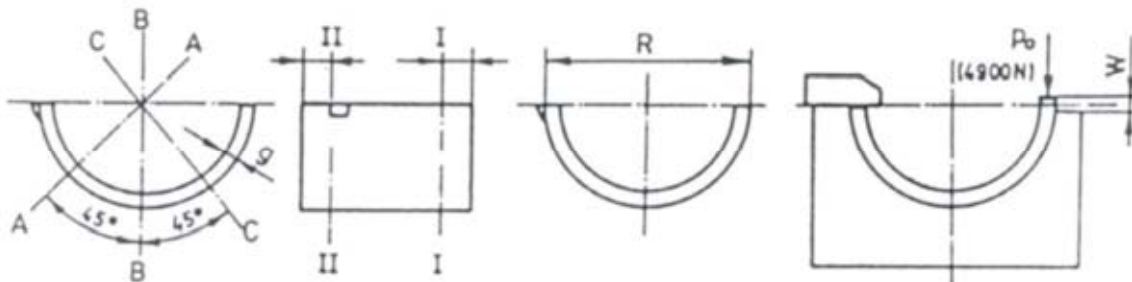

Fig. 1. Half-bearing prepared for testing on the SMOK tester: a-shape design and dimensions of standard half bearing; b-dimensions measured for the bearing after testing (after modification - reducing the length of the standard bearing), g-bearing shell thickness, R-spread, w-overlap

Tab. 1. Geometry and hardness of the MB11 bearing surface

Inner dia D of the full bearing [mm]	Effective bearing axial length L[mm]	Relative bearing clearance $\Delta R/R$	Bearing shell thickness g[mm]	Bearing alloy layer thickness g_s [mm]	Bearing sliding layer roughness R_a [μm]	Bearing journal surface hardness [HRC]	Journal sliding surface roughness R_a [μm]
52.784-52.796	14.2	0.0019-0.0021	1.820	0.240-0.312	0.20	60±2	0.16

3. Test results

Each of the 20-hour test has been divided into two 10-hour sections. After completing the section the careful examination of the sliding surface has been performed in order to find out possible fatigue cracks. The slide layer has been recognized as destroyed by fatigue, in case a net of fatigue cracks could be observed on the surface after the test, even if there are no losses of bearing material. For the test result assessments the two-point strategy [3] is adopted and then presented graphically (Fig. 2).

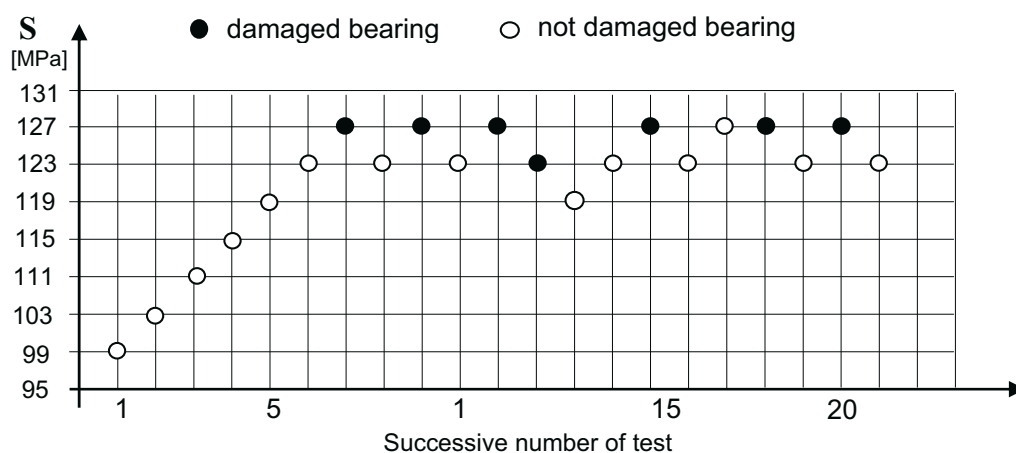

Fig. 2. Fatigue test sequence for bearing material MB11 ($L/D = 0.266$, $n = 3000$ rpm, relative clearance $\Delta r/r = 0.0019$, bearing temperature increase $\Delta T = 81^\circ\text{C}$)

Microscopic pictures of the fatigue damages are presented in Fig. 3 and Fig. 4.



Fig.3. Fatigue cracks on the slide bearing surface for the alloy MB11, obtained after the test on SMOK stand

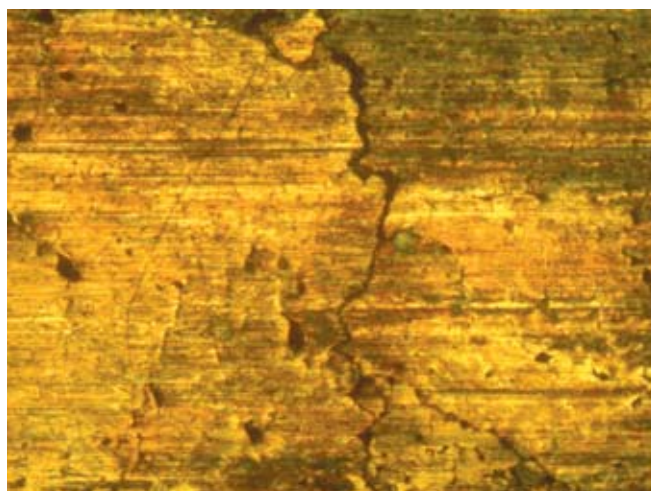

Fig. 4. Fatigue cracks on the MB11 slide layer (after test on the SMOK test stand-enlargement of the picture from Fig.3)

Fatigue cracks are appeared at the centre of the lower half-bearing. The position of the cracked area is reflecting the stress distribution (being the result of bearing housing design) in the bearing alloy. It can be concluded that the cracked area is placed in accordance with the maximum oil film pressure position and maximum circumferential pressure gradient (between 275° and 290° angular position) as it is stated in the literature [3]. The cracks initiation can start at any time of fatigue process but it can be detected only after first or second test section (after 10 or 20 hours). It results in lower precision of the determination of the cracks initiation angular position. The picture of the cracks net, that is visible on the slide surface allows to conclude that circumferential and axial normal alternating stresses are developing in the slide layer.

4. Results of physical metallurgy and fractography investigations

The chemical composition of the slide layers, the hardness measurement results of the particular regions of the slide surfaces as well as measured on the slide layer cross-section together with scanning of that area have been investigated. The slide layer chemical composition was examined with the use of energy dispersive x-ray apparatus ISIS 300, working with scanning electron microscope (Hitachi S-300N-JAPAN). The results of that measurements are shown in Tab. 2.

Tab. 2. Main chemical element composition in the slide layer of MB11 (mass percentage %) - for 4 examples

Element Line	Weight %	Weight %	Weight %	Weight %	Medium
Cu K	74.42	75.40	77.70	75.08	75.65
Sn L	4.09	4.37	4.01	4.37	4.21
Pb L	21.49	20.22	18.28	20.55	20.14
Total	100.00	100.00	100.00	100.00	100

The micro hardness, measured with the use of Vickers apparatus, is equal 86-133 HV_{0.05} (mean value is 112 HV). Mean value of the slide layer thickness is equal 0.310 mm. The metallurgical microscope Reichert type was used to perform micro and macro observation of the slide surfaces. In the Fig. 5 the pictures of the not worn bearing slide surfaces (before the test) are presented. The slide layer consists of two contrasting phases, with inclusions of the slide layer components (Pb and Sn). The bright inclusions are mainly consisting of lead (Pb). In case of great areas of the lead coagulation, inter-phase surface separations are visible, what can indicate the points of fatigue cracks initiations. Cracks of the MB11 slide layer are shown in Fig. 6. Material spalling is visible on the slide surface.

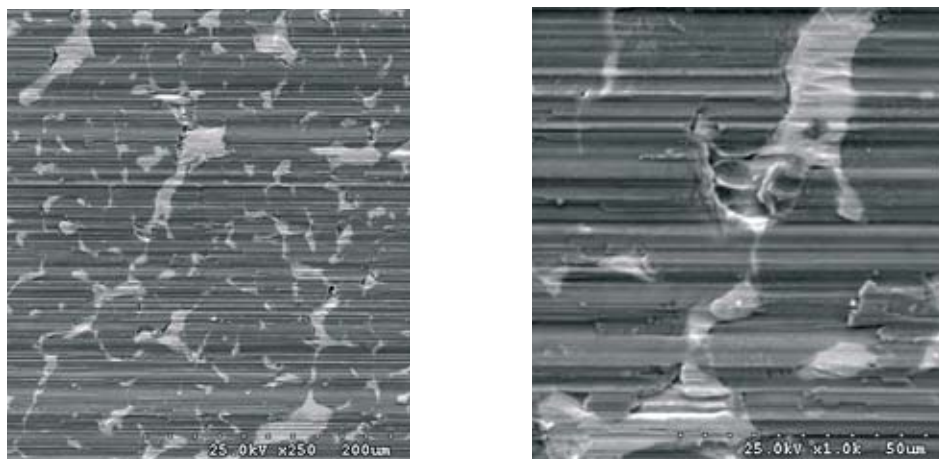

Fig. 5. Not worn slide layer of MB11 material

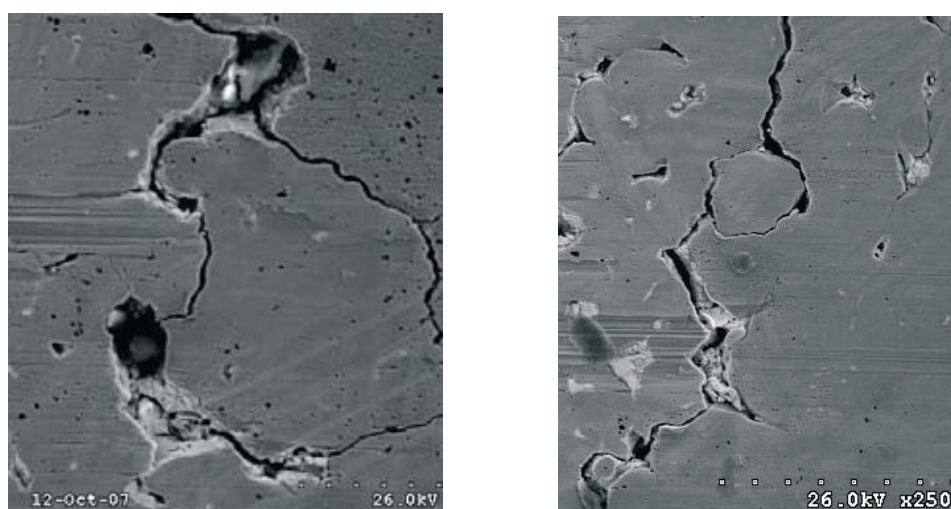

Fig.6. Cracks of the MB11 slide layer visible after the fatigue test performed on the SMOK machine

Mechanisms of the cracks propagations of the MB11 slide layer was identified on the picture presenting the development of the transverse cracks. In Fig. 7 transverse section of the MB11 slide layer is shown.

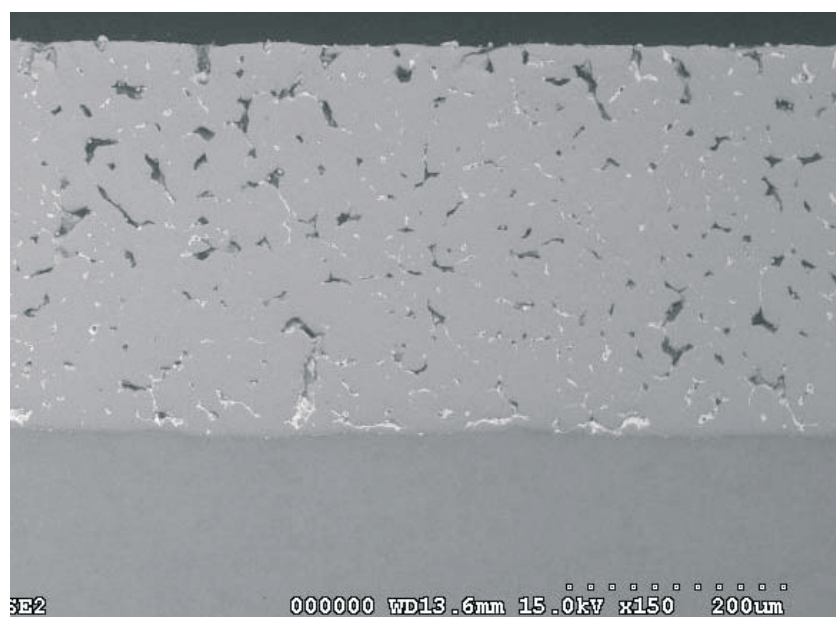

Fig. 7. MB11 transverse section of the slide layer of not worn bearing MB11 (magnification 150 x)

It could be noticed that the structure of the alloy is not uniform, a lot of voids are present at the boundary of sintered bronze elements (Fig. 8).

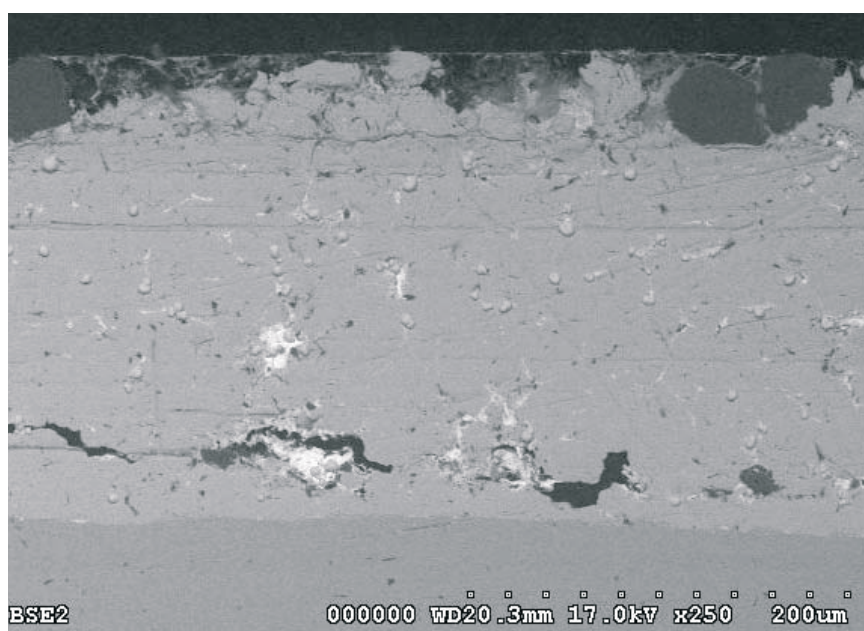

Fig. 8. MB11 transverse section of the slide layer, after the fatigue test on SMOK machine

Fatigue damage of the slide layer is of structural nature. Cracks development started at the inter-grain and propagated to the next cracks. It is also possible that cracks are initiating at the region of high lead concentration.

5. Statistical result assessment

As a statistical basis of standard test a number of 3.6×10^6 loading cycles was adopted. In the experiments S_p is understood as a maximum value of the cyclic pressure $(p_{sr})_{max}$ on the bearing sliding surface under which $P \times 100\%$ tested bearings is subject to the surface fatigue damage, after specified number of loading cycle. Probability level P , to determine S_p factor, is taken as 0.50. So the value of conventional factor $S_{0.50}$ is equal to the median of critical stress distribution for bearing that are subject to 3.6×10^6 loading cycles. Justification for adopting the median value as an estimate of bearing layer nominal fatigue critical stress is explained in literature [3] in detail. $S_{0.50}$ factor value is determined by the application of the two-point sequence method [3]. Test result processing is also described [3]. As it is shown in the Fig. 2 the two levels of the maximum pressures were defined: lower ($S_1 = 123$ MPa) - for which fatigue damage is less frequent and higher ($S_2 = 127$ MPa) - for which fatigue damage take place more frequently. The numbers of 8 and 7 bearings respectively were tested at these two loading levels (S_1 and S_2). Graphic interpretation of the alloy MB11 test results obtained on the SMOK tester is presented in the Fig. 9 while the results of statistic parameters calculations are shown in Tab. 3.

Assembly clearance as well as the change of the temperature of the tested object were taken into account for introducing the $S_{0.50}$ factor correction. Calculated $S_{0.50}$ factor can be treated as quantitative estimator for slide bearing layer fatigue resistance providing that the test results are subject to the normal distribution, and the width of the confidence interval is the same.

6. Boundary stress calculations

The boundary stress has been calculated for given value of the fatigue stress factor [1]. The calculation computer programme ABACUS [3] has been applied. The calculation results are presented in Tab. 4.

Tab. 3. The fatigue test results obtained for the slide bearings on the SMOK tester

Slide material	Statistic parameter estimation	
MB11	$S_{0.50}$ [MPa]	125.1
	$s(S)$ [MPa}	1.804
	$s(S_{0.50})$ [MPa}	1.139
	95%-confidence interval for $S_{0.50}$ - lower limit - upper limit	122.79 127.35
	95%-confidence interval for S - lower limit - upper limit	121.56 128.63
	Total number of tests	21
	Corrected $S_{0.50}$ [MPa] value	128.4

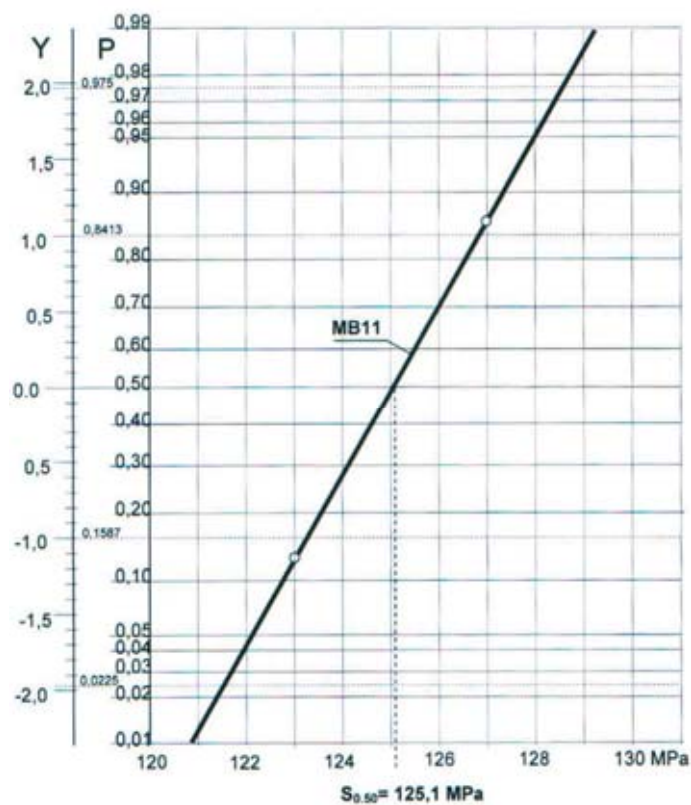

Fig. 9. P-S distribution function for fatigue test results obtained for MB11 material on the SMOK tester

Tab. 4. Boundary stress amplitude values that are corresponding to the MB11 $S_{0.50}$ factor obtained for SMOK tester investigations

Boundary circumferential stress amplitude		Boundary stress amplitude that are reduced according to the Huber method	
Stress ratio $R = \sigma_{\min} / \sigma_{\max} = -\infty$		Stress ratio $R = 0$	
Amplitude stress [MPa]	Mean stress [MPa]	Amplitude stress [MPa]	Mean stress [MPa]
247	-247	241	241



The calculated values of critical circumferential amplitude stresses have appeared to be very high for MB11 material at damaged areas (for SMOK tester). These particular stresses are normal of repeated (from 0 to maximum) compressive nature. Stresses cycles are characterized by stress ratio $R = \sigma_{\min} / \sigma_{\max} = -\infty$ and these stresses are generated as a radial stresses (practically equal to the local oil film pressure) and additionally as compressive circumferential stresses applied on limited slide surface area. In the region that is close to that area there are not tensile stresses. That can be proved by analysis of different cross-section presenting the stress distribution in the slide layers of the bearing [3].

7. Conclusions

For the loading pattern that is characteristic for the test devices such as SMOK tester, because of the nominally negative high normal stresses in the damage area, the mechanisms of cracks generation could be explained as follows:

- yield stress can be reached when during compression at the bearing working temperature the local plastic deformation can appear. After completing the test, in the region of plastic deformation, the tensile stresses can be generated due to the temperature reduction. Slide material is much more sensitive to the tensile loadings than to the compressive one, especially in the area that is weakened by empty spaces. That might be reason for cracks generation. Additionally in the case of the thin-wall bearing shell, assembled in the elastic housing, the circumferentially oriented cracks can appear. It has been observed for high bearing loadings applied on the SMOK tester. Fatigue cracks in the MB11 material tested on the SMOK machine are of the surface net pattern, positioned paralleled to the slide surface (Fig. 8). Mainly structural cracks can be noticed when analyzing the metallographic description. This is related to the porosity of the alloy structure. This is much different from the aluminum alloy structure (the bearing alloy that was previously investigated) where arterial structures of cracks were dominant. The slide surface is the place of cracks nucleation. When in slide layer there are bigger soft material elements or voids it is also possible to observe generation of cracks in any place of the bulk thickness. During consequent development of the process the micro-cracks are spreading out and going to the next defected parts of the alloys. The continuous surface of separation is then developed. The micro-cracks space net which is typical for this kind of damage is not precisely oriented but rather random. The eventually oriented fracture is due to the not uniform structure.

References

- [1] Projekt badawczy Nr 7 T07B 029 28 pt. *Badania pęknięć zmęczeniowych w panwiach hydrodynamicznych łożysk poprzecznych - estymatory wytrzymałości zmęczeniowej warstw ślizgowych*, KBN (realizowany w latach 2005-2007), Sprawozdanie, Gdańsk 2007,
- [2] Majewski, W., Kłopotcki, J., Olszewski, O., Studziński, A., *Maszyna do badania łożysk ślizgowych obciążonych dynamicznie*, Patent PL 137523.
- [3] Sikora, J., *Estymatory wytrzymałości zmęczeniowej warstwy ślizgowej łożysk poprzecznych. Metody doświadczalne w zmęczeniu materiałów i konstrukcji*, Part. II, *Badania Konstrukcji* (zbiór monografii pod redakcją naukową prof. J. Szali), Wyd. ATR, Bydgoszcz 2000.

