

Graphical presentation of the power of energy losses and power developed in the elements of hydrostatic drive and control system

Part I

Rotational hydraulic motor speed series throttling control systems

Zygmunt Paszota, Prof.

Gdansk University of Technology

ABSTRACT



Paper proposes and justifies a diagram of the direction of increase of power stream from the shaft or piston rod of a hydraulic motor to the pump shaft, power increasing as an effect of the imposed power of energy losses in the hydrostatic drive and control system elements. Graphical interpretation of the power of energy losses in the hydrostatic drive and control system elements and also of the power developed by those elements is presented. An individual system with the rotational hydraulic motor speed series throttling control fed by a constant capacity pump cooperating with an overflow valve in a constant pressure system $p = cte \approx pn$ is analyzed and also an individual system with the rotational hydraulic motor speed series throttling control fed by a constant capacity pump cooperating with an overflow valve controlled in a variable pressure system: $p = var$; an individual system with the rotational hydraulic motor speed series throttling control fed by a variable capacity pump cooperating with a pressure regulator in a constant pressure system $p = cte \approx pn$ and an individual system with the rotational hydraulic motor speed series throttling control fed by a variable capacity pump cooperating with the Load Sensing regulator in a variable pressure $p = var$ system.

Keywords: hydrostatic drive and control system, power of energy losses, energy efficiency

INTRODUCTION

The graphic presentation, by means of fields with specific areas, of the power of energy losses generated in the elements of a hydrostatic drive and control system and of power processed in the hydraulic displacement machines used in the system, becomes a tool facilitating comparison of the size of losses.

Fig. 1 presents (as an example of a system with the hydraulic motor speed series throttling control fed by a constant capacity pump cooperating with an overflow valve) a diagram of the direction of increase of power stream from the shaft or piston rod of a hydraulic motor to the pump shaft, power increasing as an effect of the imposed power of energy losses in the hydrostatic drive and control elements.

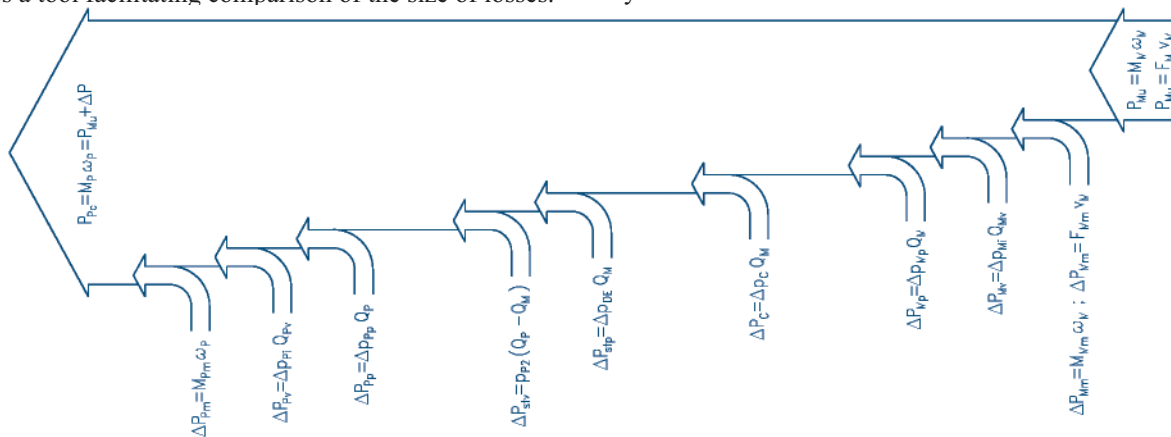

Fig. 1. The diagram presenting the direction of increase of power stream from the useful power P_{μ} on the shaft or piston rod of the hydraulic motor to the power P_{pc} consumed on the pump shaft as an effect of the power of losses generated in the hydrostatic drive and control system elements. Power P_{pc} on the pump shaft is a function (a sum) of the power P_{μ} on the shaft or piston rod of the hydraulic motor and the sum ΔP of power of losses in the elements (example of a system with the hydraulic motor speed series throttling control fed by a constant capacity pump cooperating with an overflow valve) $P_{\mu} = M_{\mu} \omega_{\mu}$ – motor useful power on the rotational motor shaft; $P_{Mm} = F_{Mm} v_M$ – motor useful power on the linear motor piston rod, $\Delta P_{Mm} = M_{Mm} \omega_M$ – power of mechanical losses in the rotational motor; $\Delta P_{Mv} = F_{Mv} v_M$ – power of mechanical losses in the linear motor; $\Delta P_{Mv} = \Delta p_{Mv} Q_{Mv}$ – power of volumetric losses in the motor; $\Delta P_{Mp} = \Delta p_M Q_M$ – power of pressure losses in the motor; $\Delta P_C = \Delta p_C Q_M$ – power of pressure losses in the system conduits, $\Delta P_{sp} = \Delta p_{DE} Q_M$ – power of structural pressure losses in the throttling control assembly (in servo-valve, directional proportional valve, set throttling valve or set two-way flow regulator), $\Delta P_{sp} = p_{sp} (Q_p - Q_M)$ – power of structural volumetric losses in the throttling control assembly (in overflow valve), $\Delta P_{pp} = \Delta p_{pp} Q_p$ – power of pressure losses in the pump, $\Delta P_{pv} = \Delta p_{pv} Q_p$ – power of volumetric losses in the pump, $\Delta P_{pm} = M_{pm} \omega_p$ – power of mechanical losses in the pump, $P_{pc} = M_p \omega_p$ – power consumed on the pump shaft

The useful power $P_{Mu} = M_M \omega_M$ determined on the rotational hydraulic motor shaft or $P_{Mu} = F_M v_M$ determined on the linear hydraulic motor piston rod, changing in the work field ($0 \leq M_M \leq M_{Mmax}$ and $0 \leq \omega_M \leq \omega_{Mmax}$) or ($0 \leq F_M \leq F_{Mmax}$ and $0 \leq v_M \leq v_{Mmax}$) of the motor driven device, is a result of instantaneous requirements of the device toward motor both as regards load M_M (F_M) and speed ω_M (v_M). Therefore, the instantaneous useful power P_{Mu} is independent of the structure of hydraulic system (used for changing the motor speed ω_M (v_M)) and of the power ΔP of losses in the system elements. However, this does not apply to the upper limits of the device parameter ranges, i.e. maximum load M_{Mmax} (F_{Mmax}) and maximum speed ω_{Mmax} (v_{Mmax}).

The upper limits of work field, determined by the $M_{Mmax} = f(\omega_M)$ and $\omega_{Mmax} = f(M_M)$ or $F_{Mmax} = f(v_M)$ and $v_{Mmax} = f(F_M)$ lines, of the hydraulic motor driving the device, depend on the theoretical capacity Q_{pt} of the pump in the system, on the nominal pressure p_n level of the system operation (the product $Q_{pt} p_n$ is the reference power), on the motor speed control structure used, and also on the sum ΔP of power of losses in the system elements. The upper limits of the motor work field differ in systems with different motor speed control structures.

On the other hand, the instantaneous power $P_{pc} = M_p \omega_p$, absorbed (consumed) by the pump from the drive (electric, internal combustion) motor, determined on the pump shaft, is a sum of the instantaneous useful power P_{Mu} of the hydraulic motor and instantaneous sum ΔP of power of losses in the hydraulic system elements: $P_{pc} = P_{Mu} + \Delta P$.

Power P_{pc} on the pump shaft is equal to the sum ΔP of power of energy losses in the system elements ($P_{pc} = \Delta P$) during the operation with unloaded motor (when $M_M = 0$ or $F_M = 0$) or with the stopped motor (when $\omega_M = 0$ or $v_M = 0$). The useful power P_{Mu} of the motor and energy efficiency η of the system are then equal to zero ($P_{Mu} = 0$, $\eta = 0$). The information on the level of power P_{pc} absorbed then by the pump and entirely lost in the system is particularly important at the system operation with unloaded motor (when $M_M = 0$ or $F_M = 0$). Power P_{pc} of the pump operating with hydraulic motor stopped (when $\omega_M = 0$ or $v_M = 0$) may be minimized by simultaneous cutting of the pump discharge conduit from the hydraulic motor and connecting this conduit with the tank, i.e. unloading the pump. However, this is only possible in an individual system, when the pump feeds only one hydraulic motor.

In references [1 – 6] and other dealing with energy aspects of the hydrostatic transmission operation a need is discussed of determining the energy efficiency of those transmissions in terms of the power of the mechanical, volumetric and pressure losses in them.

In references [7 – 10] an approach is presented to the problems of energy losses in the hydrostatic drive system elements. It has been concluded, that the often practiced method of presenting the energy losses as a function of parameters depending on those losses should be abandoned.

Reference [10] ends with the following conclusions:

- * the energy losses in the elements and also power of those losses should be presented as a function of parameters independent of those losses
- * definition of the efficiency of system elements as a relation of the respective hydraulic and mechanical powers increasing in the power stream from the shaft or piston rod of a hydraulic motor to the pump shaft is a form of precise description of the value of those efficiencies
- * description of the power of losses and energy efficiencies (presented in references [7 – 10]) is based on the principle of equality of the power absorbed by the pump with the sum of hydraulic motor useful power and power of losses in the

system elements, and also on the principle of equality of the system energy efficiency, expressed as a relation of the motor useful power to the pump absorbed power, with the product of the system element energy efficiencies

- * comparing the power of losses in the system elements gives an information facilitating the system design
- * presenting the fields of the power of losses in the system elements allows to draw conclusions about e.g. minimization of the power of structural volumetric and pressure losses in the motor speed throttling control assembly elements, in the proportional control systems and in the hydraulic servomechanism systems
- * graphical interpretation, by means of the field areas of the power of the energy losses in the hydrostatic drive system elements and of power developed by the elements, allows to compare powers of those losses with the area of the field of reference power given by the product $Q_{pt} p_n$ of theoretical pump capacity and the system nominal pressure
- * graphical interpretation of the power of losses allows to evaluate directly the energy savings after introducing the energy – saving solutions, allows to compare directly the energy losses due to change of the working medium viscosity or replacing the oil by oil – water emulsion or water.

References [8,10] present an example (without any comment) of the graphical interpretation of the power of losses in a system with the hydraulic motor speed series throttling control fed by a constant capacity pump cooperating with an overflow valve in a constant pressure system.

This publication presents and analyses the field areas of the power of energy losses in the hydraulic system elements with different rotational hydraulic motor speed control structures. Deliberations allow to realise the rules deciding of the size of fields of power losses in the instantaneous motor operation parameters required by the motor driven device, i.e. instantaneous load M_M and speed ω_M (n_M). Deliberations allow to draw conclusions on achieving high energy efficiency η of a system with selected structure and also conditions that must be fulfilled in order to achieve that high efficiency. Deliberations allow also to compare the power of losses connected with the used hydraulic motor speed control structure and the power P_{pc} absorbed (consumed) by the pump from the drive (electric or internal combustion) motor, the power necessary to ensure the required useful power $P_{Mu} = M_M \omega_M$ of the pump driven hydraulic motor.

The paper consists of two parts. This Part I presents graphical interpretation of the power of energy losses and power developed in the elements of systems of the rotational hydraulic motor speed series throttling control, Part II – the same problems but related to the systems with parallel throttling control and volumetric control of the rotational hydraulic motor speed.

SYSTEM OF THE MOTOR SPEED SERIES THROTTLING CONTROL FED BY A CONSTANT CAPACITY PUMP COOPERATING WITH AN OVERFLOW VALVE IN CONSTANT PRESSURE CONDITIONS

Fig. 2 presents graphical interpretation of the power of energy losses in elements of an individual system with the rotational hydraulic motor speed series throttling control, fed by a constant capacity pump cooperating with an overflow valve in a constant pressure system $p = cte \approx p_n$.

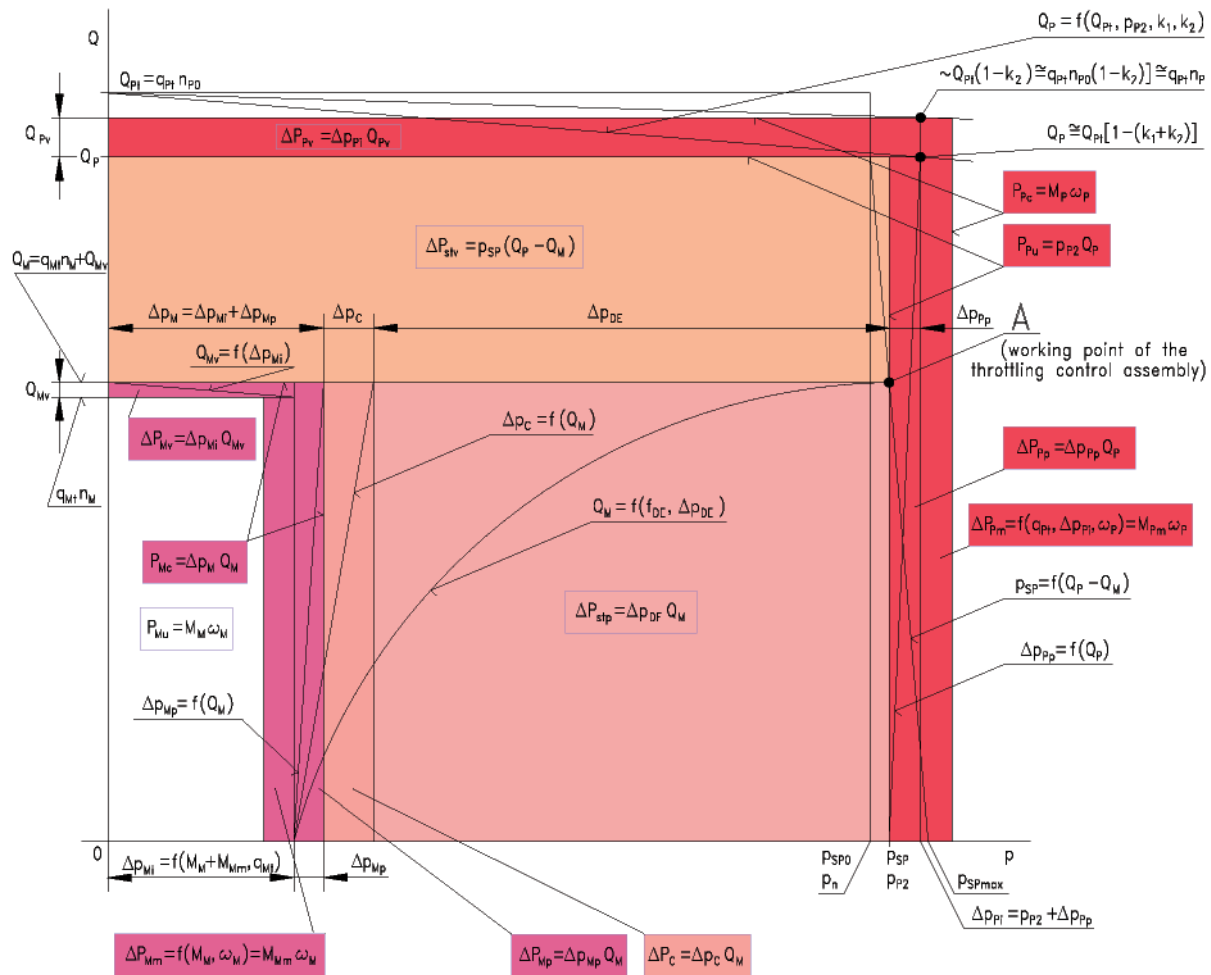

Fig. 2. Graphical interpretation of power losses in a hydrostatic drive and control system elements. Individual system with rotational hydraulic motor speed series throttling control fed by a constant capacity pump cooperating with an overflow valve in a constant pressure system: $p = cte \approx p_n$ (coefficient „a” of pressure increase in the overflow valve $a > 0$); the series throttling control assembly in the form of: 1. servo-valve, 2. proportional directional valve, 3. set throttling valve, 4. set two – way flow regulator; k_1 – coefficient of the intensity Q_{pv} of volumetric losses in the pump; k_2 – coefficient of the decrease of pump shaft rotational speed n_p compared with speed n_{p0} of unloaded pump

The series throttling control assembly used in the system may be a servo-valve or proportional directional valve (Fig. 3) or else a set throttling valve or a set two – way flow regulator placed at the motor inlet (Fig. 4).

Graphical interpretation (Fig. 2) of the power of energy loss (in the system elements) field area and field area of power developed in those elements allows to compare the losses with the field area of reference power determined by the product $p_n Q_{pt}$ of the system nominal pressure p_n (assumed here as opening pressure p_{SP0} of the overflow valve) and the theoretical capacity $Q_{pt} = q_{pt} n_{p0}$ of the pump.

Nominal pressure p_n of the pump operation corresponds to the need of assuring maximum decrease Δp_{Mmax} of the hydraulic motor pressure guaranteeing (with a given capacity q_{M1} per one motor revolution) meeting the maximum torque M_{Mmax} that the motor may be loaded with, from time to time, by the driven device.

The theoretical pump capacity Q_{pt} , on the other hand, meets the need of assuring maximum hydraulic shaft angular speed ω_{Mmax} (rotational speed n_{Mmax}) required by the driven device.

It has to be noted that assumption of an equal field $p_n Q_{pt}$ of reference power in all the control structures leads to slightly different ranges of the change of speed $0 \leq \omega_M \leq \omega_{Mmax}$ and load $0 \leq M_M \leq M_{Mmax}$ of the hydraulic motor controlled by those structures.

The actual hydraulic motor useful power $P_{Mu} = M_M \omega_M$ is a result of the product of current torque M_M , which the hydraulic motor is loaded with by the driven device, and the current motor

shaft angular speed ω_M , also required at a given moment by the driven device.

Therefore, the motor useful power P_{Mu} depends on the current requirements of the driven device and is independent of the control structure and of the losses in elements of the hydrostatic drive system with a defined structure.

But powers ΔP of losses in the hydraulic system elements are a function of the current value of useful power P_{Mu} , i.e. a function of current torque M_M and current motor shaft speed ω_M . Besides, it depends on the structure of the motor speed control system and on the quality of the hydraulic system components (the level of energy losses in them).

In Fig. 2, the actual hydraulic motor useful power $P_{Mu} = M_M \omega_M$, transmitted to the driven device by the motor shaft, is presented as the field of the white rectangular, with the following fields „added” to it:

- ▲ field $\Delta P_{Mm} = M_{Mm} \omega_M$ of the power of mechanical losses in the hydraulic motor
- ▲ field $\Delta P_{Mv} = \Delta p_{Mv} Q_{Mv}$ of the power of volumetric losses in the hydraulic motor
- ▲ field $\Delta P_{Mp} = \Delta p_{Mp} Q_M$ of the power of pressure losses in the hydraulic motor
- ▲ field $\Delta P_C = \Delta p_C Q_M$ of the power of pressure losses in the system conduits
- ▲ field $\Delta P_{stp} = \Delta p_{DE} Q_M$ of the power of structural pressure losses in the throttling control assembly (in servo-valve, directional proportional valve, set throttling valve or set two – way flow regulator)

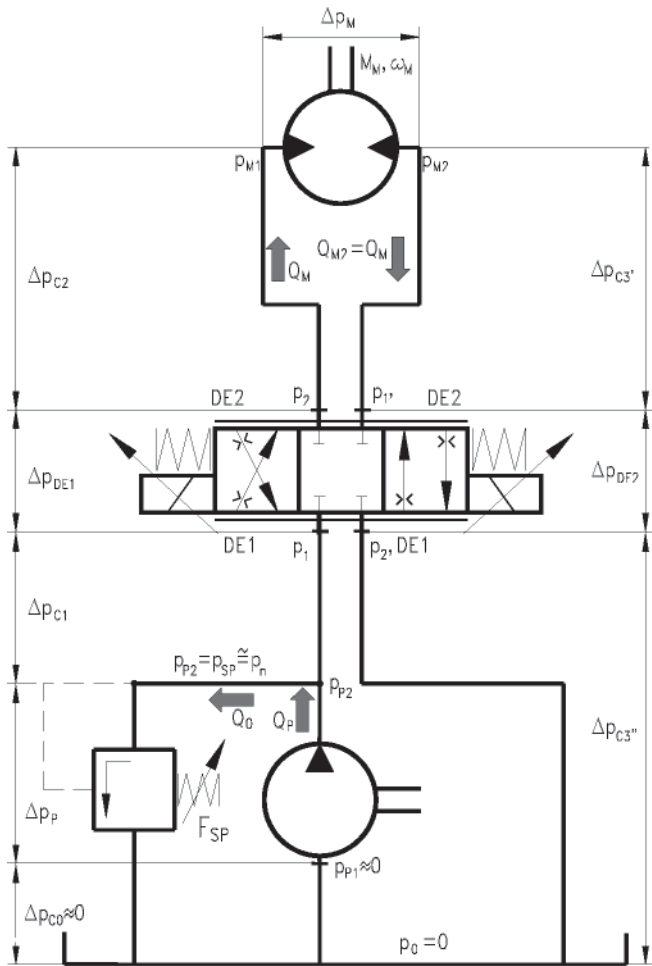

Fig. 3. Individual system of the rotational hydraulic motor speed series throttling control fed by a constant capacity pump cooperating with an overflow valve in constant pressure conditions $p_{p2} = cte \approx p_n$; the throttling control assembly in the form of servo-valve or proportional directional valve

- ▲ field $\Delta P_{stv} = p_{SP} (Q_p - Q_m)$ of the power of structural volumetric losses in the throttling control assembly (in overflow valve)
- ▲ field $\Delta P_{pp} = \Delta p_{pp} Q_p$ of the power of pressure losses in the pump
- ▲ field $\Delta P_{pv} = \Delta p_{pv} Q_{pv}$ of the power of volumetric losses in the pump
- ▲ field $\Delta P_{pm} = M_{pm} \omega_p$ of the power of mechanical losses in the pump.

The sum of the field areas of the hydraulic motor current useful power P_{Mu} rectangle and the field areas of rectangles ΔP representing the power of individual losses occurring at a given moment of work in the hydrostatic drive and control system elements constitutes the rectangle field area corresponding to the actual power P_{pc} absorbed (consumed) by the pump from the electric or internal combustion driving motor, resulting from the product of current torque M_p and current pump shaft angular speed ω_p ($P_{pc} = M_p \omega_p$).

Power P_{pc} absorbed by the pump from its drive motor is greater than the reference power $p_n Q_{pt}$ resulting from the product of nominal pressure p_n and theoretical pump capacity Q_{pt} .

The required level of nominal pressure p_n of pump operation and the required level of pump theoretical capacity Q_{pt} during the system operation, as well as the current small loading torque M_M and current small hydraulic motor shaft angular speed ω_M are decisive in that motor speed throttling control structure of

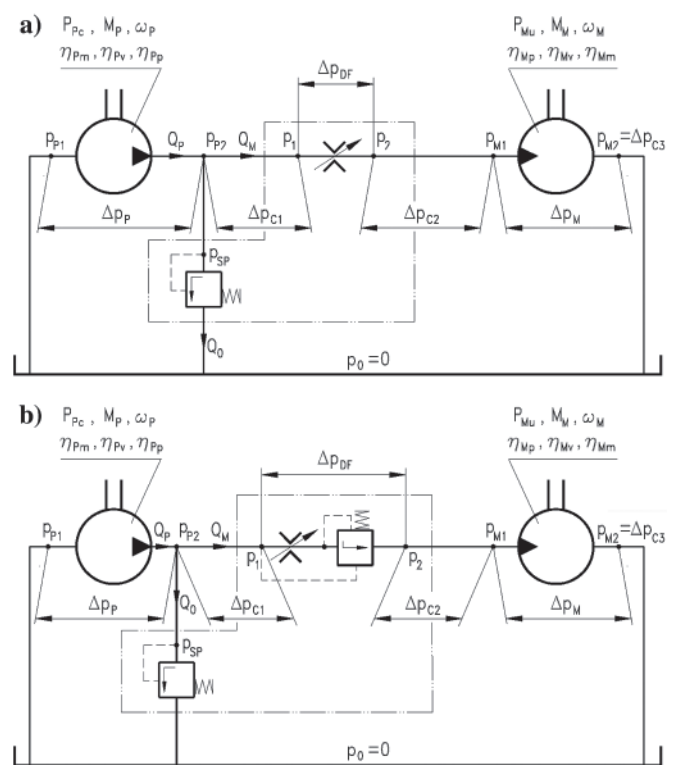

Fig. 4. Individual system of the rotational hydraulic motor speed series throttling control fed by a constant capacity pump cooperating with an overflow valve in constant pressure conditions $p_{p2} = cte \approx p_n$; the throttling control assembly in the form of: a) set throttling valve, b) set two-way flow regulator

temporary power ΔP_{stp} of structural pressure losses and power ΔP_{stv} of structural volumetric losses. This is then accompanied by a very low value of the overall energy efficiency η of the system.

The power ΔP_{stp} of the structural pressure losses in the throttling control assembly may be reduced almost to zero during the hydraulic motor operation at the maximum shaft load M_{Mmax} .

The power ΔP_{stv} of the structural volumetric losses in the throttling control assembly may be reduced almost to zero in a situation when the hydraulic motor operates with maximum angular speed ω_{Mmax} (rotational speed n_{Mmax}).

The hydraulic motor operation with maximum load M_{Mmax} and simultaneous maximum speed ω_{Mmax} (n_{Mmax}) may cause minimization of the power of losses connected with the motor speed throttling control and the sum of energy losses in the system consists of the hydraulic motor losses, the conduit losses and pump losses. The overall system efficiency η reaches then a high value η_{max} , close to the value of energy efficiency η_{max} of a system with the motor speed volumetric control (by a variable capacity pump).

However, in order to be able, in a system with series throttling control, to load the hydraulic motor with a maximum torque M_{Mmax} close to the maximum load M_{Mmax} of the motor in a system with volumetric speed control, the throttling slot of the throttling proportional control valve (or of the throttling valve) has to be increased to the size requiring a small decrease $\Delta p_{DEmin} \approx 0$ of pressure at the maximum flow intensity $Q_{Mmax} \approx Q_p$.

On the other hand, in order to be able, in a system with series throttling control, to set, with a throttling proportional control valve or a throttling valve, the maximum intensity $Q_{Mmax} \approx Q_p$ i.e. close to the pump capacity, an overflow valve has to be used in the system to stabilize the pressure level $p_{SP} \approx p_n$ of the pump operation at the flow intensity $Q_p - Q_M \approx 0$ (i.e. close to zero).

System of the motor speed series throttling control fed by a constant capacity pump cooperating with an overflow valve controlled in variable pressure conditions

Fig. 5 presents graphical interpretation of the power of energy losses in the elements of an individual system with the rotational hydraulic motor speed series throttling control, fed by a constant capacity pump cooperating with an overflow valve controlled in a variable pressure system: $p = \text{var}$. The series throttling control assembly used in the system may have a form of servo-valve or proportional directional control valve (Fig. 6) or else a set throttling valve (creating, with the controlled overflow valve, a set three – way flow regulator) or a set two – way flow regulator placed at the motor inlet (Fig. 7).

The pump operation pressure p_{p2} , controlled by the overflow valve with remote pilot control (SPS), is set to a level higher by a value $\Delta p_{SPS} = \Delta p_{DE1} |_{f_{DE1max}, Q_{Pt}} + \Delta p_{C1max} = cte$ than the current pressure p_2 in the throttling proportional valve outlet conduit to the hydraulic motor. The pressure difference $\Delta p_{SPS} = p_{p2} - p_2$ must allow to achieve, through the throttling proportional valve slot DE1, controlling the hydraulic motor feed flow intensity Q_M , the flow intensity Q_M equal to the theoretical pump capacity Q_{Pt} ($Q_M = Q_{Pt}$). The area of DE1 slot reaches then the maximum value f_{DE1max} , with a possibility of achieving the pressure decrease $\Delta p_{DE1} |_{f_{DE1max}, Q_{Pt}}$ required by the throttling proportional valve structure, with simultaneous ability to overcome the maximum flow resistance value Δp_{C1max} in the segment between the pump and the throttling proportional valve. Pressure p_1 before the throttling proportional valve slot DE1 equals $p_1 = p_{p2} - \Delta p_{C1}$.

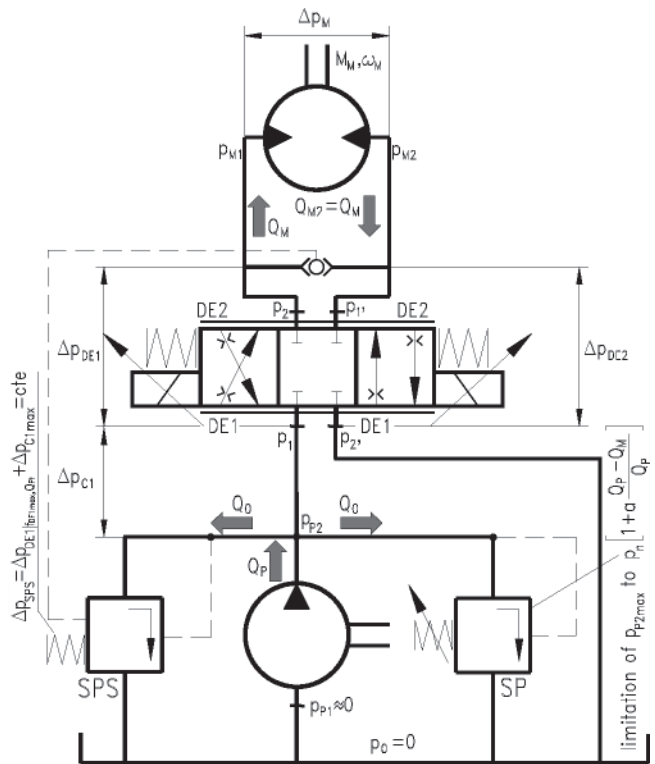

Fig. 6. Individual system of the rotational hydraulic motor speed series throttling control fed by a constant capacity pump cooperating with an overflow valve controlled in variable pressure conditions $p_{p2} = \text{var}$; the throttling control assembly in a form of servo – valve or directional proportional valve

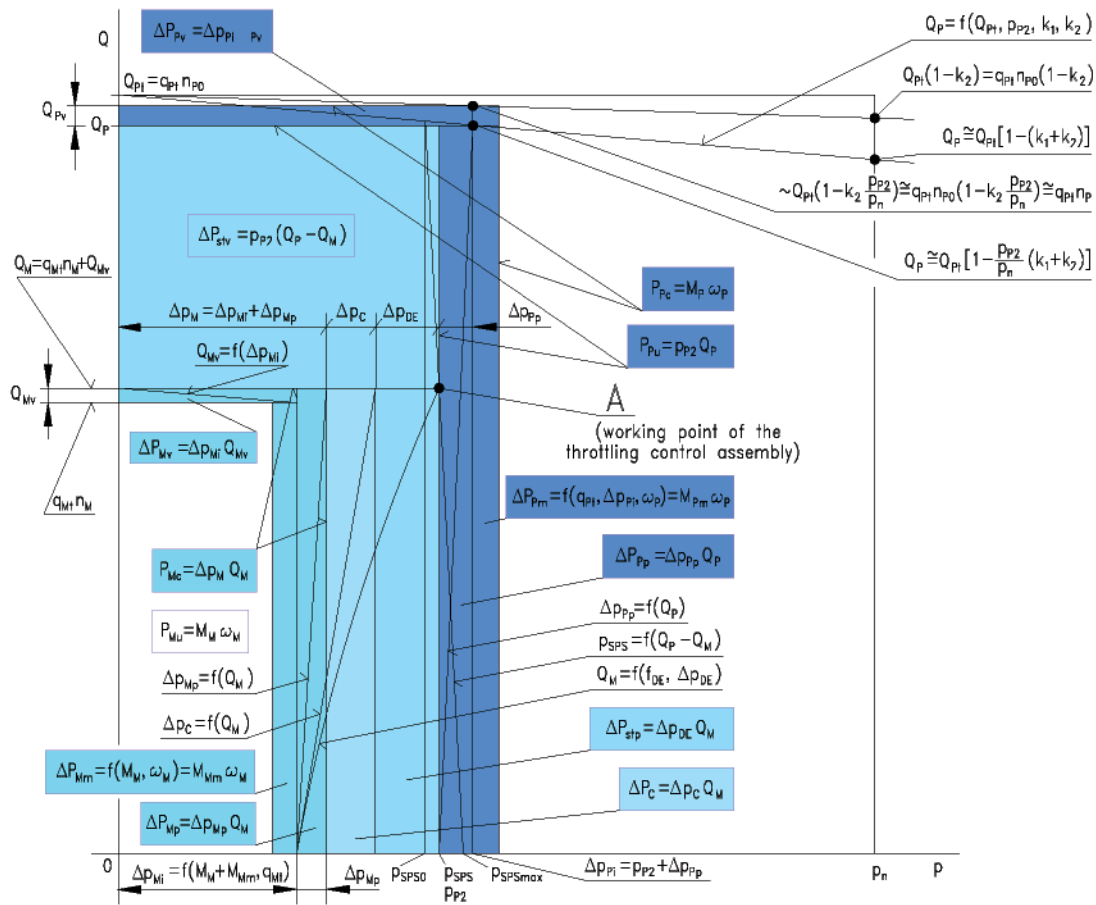

Fig. 5. Graphical interpretation of power losses in a hydrostatic drive and control system elements. Individual system with rotational hydraulic motor speed series throttling control fed by a constant capacity pump cooperating with a controlled overflow valve in a variable pressure system – $p = \text{var}$ (coefficient „a” of pressure increase in the controlled overflow valve $a > 0$); the series throttling control assembly in the form of: 1. servo-valve, 2. proportional directional valve; 3. set throttling valve (together with controlled overflow valve forming a three – way set flow regulator)

The current value of pump discharge pressure p_{p2} , higher by Δp_{SPS} than the current value of the throttling proportional valve outlet (to the hydraulic motor) pressure p_2 , is a result of the pressure p_{M1} required by the motor at its inlet. The maximum limit value p_{p2max} of pressure in the pump discharge conduit is determined by the overflow valve SP with opening pressure p_{SP0} equal to the system nominal pressure p_n .

This solution significantly reduces (compared with the constant pressure feeding system) the power $\Delta P_{stp} = \Delta p_{DE} Q_M$ of structural pressure losses in the throttling control assembly, occurring during the hydraulic motor loading with a decreasing torque M_M .

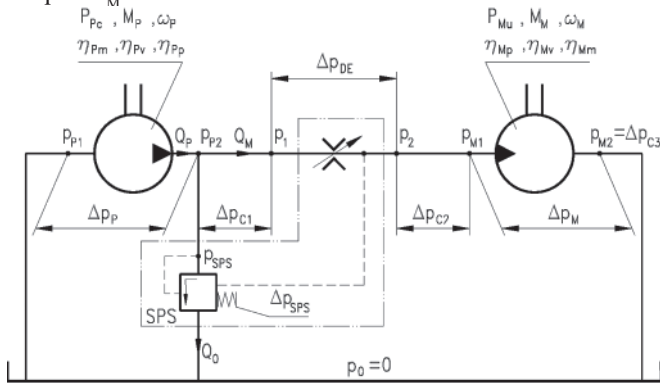

Fig. 7. Individual system of the rotational hydraulic motor speed series throttling control fed by a constant capacity pump cooperating with an overflow valve controlled in variable pressure conditions $p_{p2} = \text{var}$; the throttling control assembly in a form of three-way flow regulator

The power $\Delta P_{stv} = p_{SPS} (Q_p - Q_M)$ of structural volumetric losses in the controlled overflow valve is then also reduced, although the flow intensity $Q_0 = Q_p - Q_M$ of volumetric losses in that valve increases slightly compared with the constant pressure feeding system (Fig. 2) due to a higher pump capacity Q_p (at a lower pump operating pressure p_{p2}).

In a rotational hydraulic motor operating in both systems ($p = \text{cte}$ and $p = \text{var}$) the three values of power of energy losses (ΔP_{Mm} , ΔP_{Mv} and ΔP_{Mp}) are practically the same (with a slight tendency to lower the power ΔP_{Mm} of mechanical losses and power ΔP_{Mv} of volumetric losses in a motor operating in a $p = \text{var}$ system).

Power $\Delta P_C = \Delta p_C Q_M$ of pressure losses in the $p = \text{var}$ system conduits is the same as in a $p = \text{cte}$ system.

In a pump, due to its operation in a variable pressure feeding system, the power $\Delta P_{pp} = \Delta p_{pp} Q_p$ of pressure losses is slightly increased, power $\Delta P_{pv} = \Delta p_{pv} Q_{pv}$ of volumetric losses is decreased and power $\Delta P_{pm} = M_{pm} \omega_p$ of mechanical losses is also decreased.

In effect, when the hydraulic motor is loaded with a small torque M_M , the power $\Delta P_{pc} = M_p \omega_p$ absorbed by the pump from the drive (electric or internal combustion) motor is also significantly reduced, which, with an unchanged hydraulic motor useful power $P_{Mm} = M_M \omega_M$, increases the overall system energy efficiency η compared with the constant pressure feeding system efficiency η .

Both structures ($p = \text{cte}$ and $p = \text{var}$) of the hydraulic motor speed series throttling control, fed by a constant capacity pump, may achieve, during maximum motor load M_{Mmax} and simultaneous maximum speed ω_{Mmax} (n_{Mmax}), the same maximum overall system efficiency η_{max} . It is close to the maximum energy efficiency η_{max} of a system with volumetric control (by a variable capacity pump) of hydraulic motor speed. The $p = \text{var}$ system becomes then a $p = \text{cte}$ system, therefore the operating conditions of both systems are the same and structural losses ΔP_{stp} and ΔP_{stv} in the throttling control assembly may be practically eliminated. However, similarly as in the constant

capacity pump system $p = \text{cte}$, it requires increased area of the f_{DEmax} slot in the throttling directional control valve (throttling valve) to a size requiring slight pressure decrease $\Delta p_{DEmin} \approx 0$ at the maximum flow intensity $Q_{Mmax} = Q_p$. It requires also the use of a controlled overflow valve stabilizing the value $\Delta p_{SPS} = p_{p2} - p_2 = \text{cte}$ also at the flow intensity $Q_p - Q_M \approx 0$ (close to zero) and an overflow valve stabilizing the pressure level $p_{SP} \approx p_n$ at the flow intensity $Q_p - Q_M \approx 0$.

SYSTEM OF THE MOTOR SPEED SERIES THROTTLING CONTROL FED BY A VARIABLE CAPACITY PUMP COOPERATING WITH REGULATOR IN THE CONSTANT PRESSURE CONDITIONS

Fig. 8 describes the power of energy losses in the elements of an individual system with the rotational hydraulic motor speed series throttling control, fed by a variable capacity pump cooperating with a pressure regulator in a constant pressure system $p = \text{cte} \approx p_n$. The series throttling control assembly used in the system may have a form of servo-valve or proportional directional control valve (Fig. 9) or else a set throttling or a set two-way flow regulator placed in the motor inlet (Fig. 10 – example of a central system with parallelly situated motors and with variable capacity pump cooperating with pressure regulator $p_{p2} = \text{cte} \approx p_n$ – during one motor operation).

The use, as a source of supply of the hydraulic motor series throttling control system, an assembly consisting of a variable capacity pump and a constant pressure $p_{p2} = \text{cte} \approx p_n$ regulator entirely eliminates structural volumetric losses. The current pump capacity Q_p is adjusted by the pressure regulator to the current flow intensity Q_M set by the throttling assembly, therefore the pump capacity Q_p is equal to the hydraulic motor absorption capacity Q_M ($Q_p = Q_M$) and the power $\Delta P_{stv} = p_{p2} (Q_p - Q_M) = 0$.

Power $\Delta P_{stp} = \Delta p_{DE} Q_M$ of structural pressure losses in the series throttling control assembly fed at a constant pressure by a variable capacity pump fitted with a pressure regulator is close to the power of structural pressure losses when the assembly is fed by pressure $p_{p2} = \text{cte} \approx p_n$ of a constant capacity pump cooperating with an overflow valve (Fig. 2).

Power of mechanical losses ΔP_{Mm} , volumetric losses ΔP_{Mv} and pressure losses ΔP_{Mp} occurring in the rotational hydraulic motor remains practically unchanged.

Power $\Delta P_C = \Delta p_C Q_M$ of pressure losses in the system conduits is not changed here compared with the above described systems with a constant capacity pump.

In the variable capacity pump feeding (together with the pressure regulator) the throttling control assembly at the pressure $p_{p2} = \text{cte} \approx p_n$, the power of pressure losses $\Delta P_{pp} = \Delta p_{pp} Q_p$ is reduced (due to decrease of Q_p and Δp_{pp}). Power $\Delta P_{pv} = \Delta p_{pv} Q_{pv}$ of volumetric losses in the pump is practically the same as in a constant capacity pump operating at pressure $p_{p2} = \text{cte} \approx p_n$. However, the power $\Delta P_{pm} = M_{pm} \omega_p$ of mechanical losses in the pump is reduced compared with a constant capacity pump operating in the $p_{p2} = \text{cte} \approx p_n$ system (due to decrease of M_{pm}).

The use, as a hydraulic motor series throttling speed control system feeding source, a variable capacity pump with pressure regulator, operating at pressure $p_{p2} = \text{cte} \approx p_n$, allows, during the motor run with small speed ω_M (n_M), to reduce significantly the power $P_{pc} = M_p \omega_p$ absorbed by the pump from the drive electric or internal combustion motor. With the unchanged useful power $P_{Mu} = M_M \omega_M$ of the hydraulic motor, the entire system energy

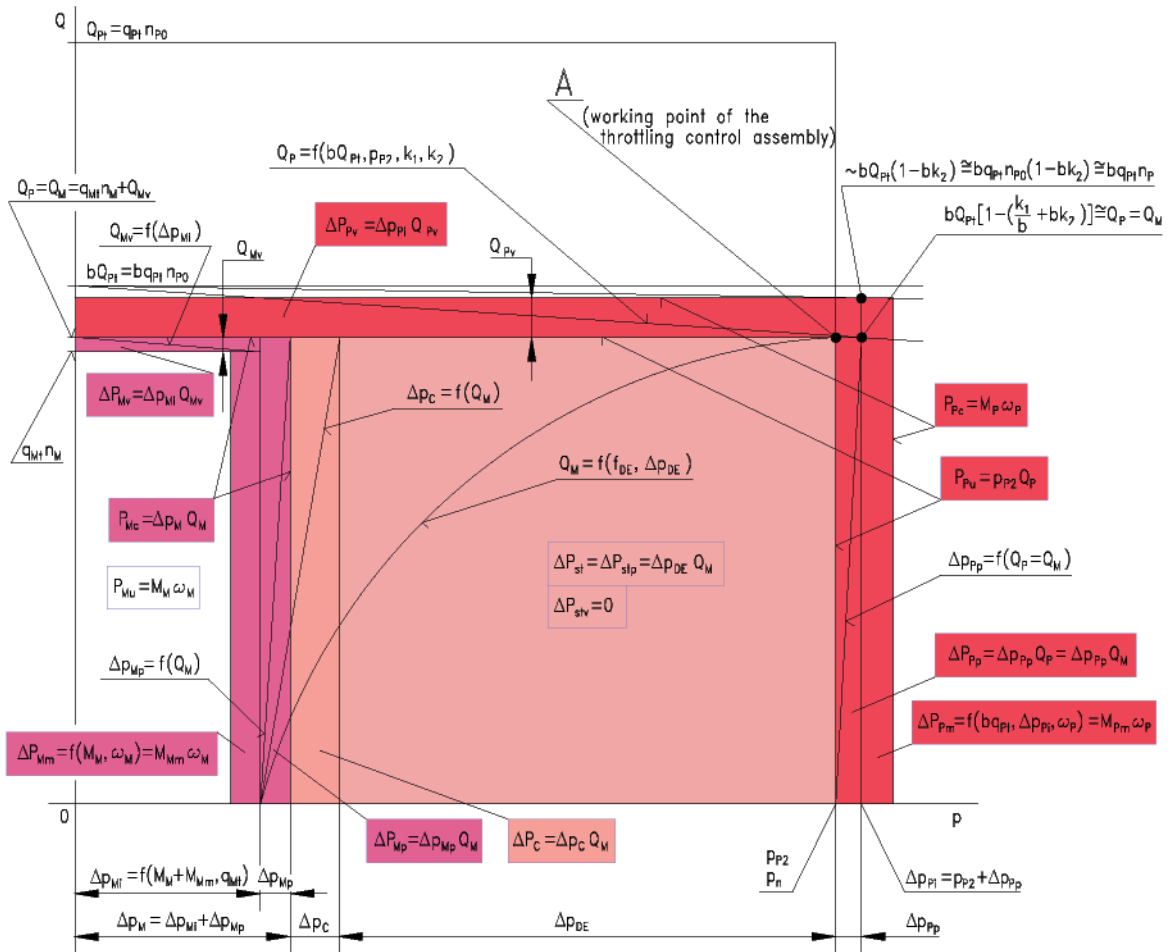

Fig. 8. Graphical interpretation of power losses in a hydrostatic drive and control system elements. Individual system with rotational hydraulic motor speed series throttling control fed by a constant capacity pump cooperating with pressure regulator in a constant pressure system: $p = cte \approx p_n$ (coefficient „ a_1 ” of pressure increase in the regulator $a_1 = 0$); the series throttling control assembly in the form of: 1. servo-valve, 2. proportional directional valve, 3. set throttling valve, 4. set two – way flow regulator

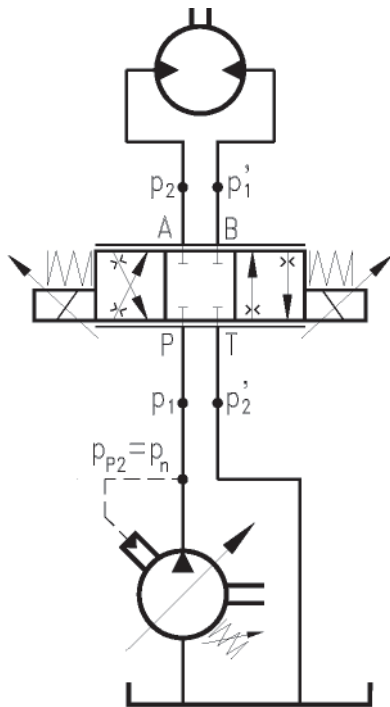

Fig. 9. Individual system with the rotational hydraulic motor speed series throttling control fed by a variable capacity pump cooperating with regulator in the constant pressure conditions $p_{p2} = cte \approx p_n$; the throttling control assembly in the form of servo-valve or proportional directional valve

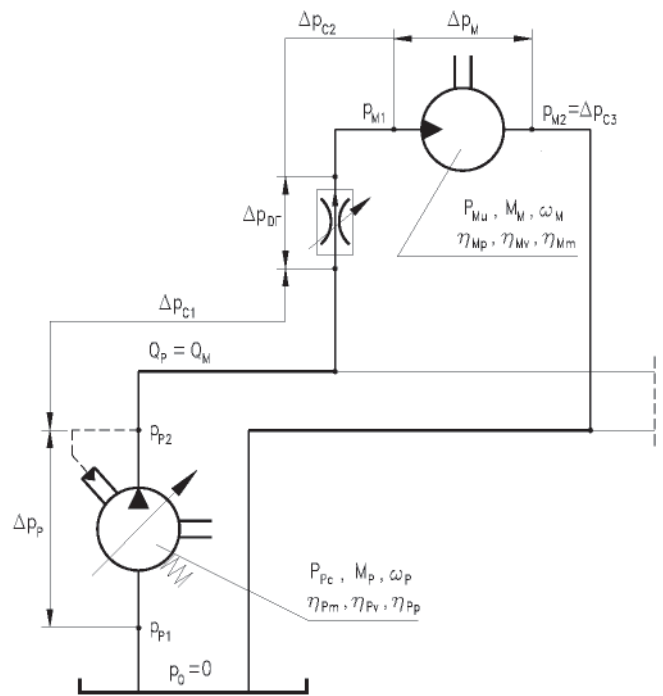

Fig. 10. Central system with parallelly situated motors and with variable capacity pump cooperating with pressure regulator in the constant pressure conditions $p_{p2} = cte \approx p_n$ – during one motor operation

efficiency η is significantly higher compared with efficiency η of a constant pressure ($p = \text{cte}$) throttling assembly constant capacity pump feeding system.

The considered system may achieve, during the maximum hydraulic motor load $M_{M_{\text{max}}}$ and in the whole range of the motor speed change $0 \leq \omega_M \leq \omega_{M_{\text{max}}}$, the overall efficiency η close to the value of energy efficiency η of a system with the motor speed volumetric control (by a variable capacity pump). The power $\Delta P_{\text{stp}} = \Delta p_{\text{DE}} Q_M$ of the structural pressure losses is then minimalized. It requires, in a system with the hydraulic motor speed series throttling control, an increased area of the f_{DEmax} slot in the throttling directional control valve (or the throttling valve) to a size requiring slight pressure decrease $\Delta p_{\text{DEmin}} \approx 0$ at the maximum flow intensity $Q_{M_{\text{max}}} = Q_{P_{\text{max}}}$, i.e. equal to the full pump capacity. It requires also correct operation of the pump pressure regulator stabilizing the pump discharge pressure p_{p2} at the level $p_{p2} = \text{cte} \approx p_n$ in the whole range $0 \leq Q_p \leq Q_{P_{\text{max}}}$ of the pump capacity variation.

In a situation of simultaneous maximum load $M_{M_{\text{max}}}$ and maximum speed $\omega_{M_{\text{max}}}$ of a hydraulic motor controlled by series throttling, the maximum achievable energy efficiency η_{max} of a system is close to the value η_{max} of a system with hydraulic motor speed volumetric control i.e. directly by a variable capacity pump.

The greatest energy savings in the considered series throttling control system, compared with a series control system fed by a constant pressure constant capacity pump, are obtained during the hydraulic motor operation at small speed $\omega_M (n_M)$.

SYSTEM OF THE MOTOR SPEED SERIES THROTTLING CONTROL FED BY A VARIABLE CAPACITY PUMP COOPERATING WITH A *LOAD SENSING* REGULATOR IN THE VARIABLE PRESSURE CONDITIONS

Fig. 11 illustrates the fields of power of energy losses in elements of **an individual system with the rotational hydraulic motor speed series throttling control, fed by a variable capacity pump cooperating with the *Load Sensing* regulator in a variable pressure $p = \text{var}$ system.** The series throttling control assembly may have a form of servo-valve or proportional directional valve (Fig. 12) or else a set throttling valve or a set two – way flow regulator placed at the motor inlet (Fig. 13 – example of a central system with parallelly situated motors and with variable capacity pump cooperating with *Load Sensing* regulator – during one motor operation).

The use, as a supply source of the hydraulic motor speed series throttling control assembly, of a set consisting of a variable capacity pump cooperating with a *Load Sensing* (LS) regulator, totally eliminates the structural volumetric losses in a system. Similarly as in the series throttling control system fed by a variable capacity pump cooperating with the $p_{p2} = \text{cte} \approx p_n$ regulator, i.e. at the constant pressure feeding, the structural volumetric losses are eliminated here. Power ΔP_{stv} of those losses is equal to zero ($\Delta P_{\text{stv}} = p_{p2} (Q_p - Q_M) = 0$),

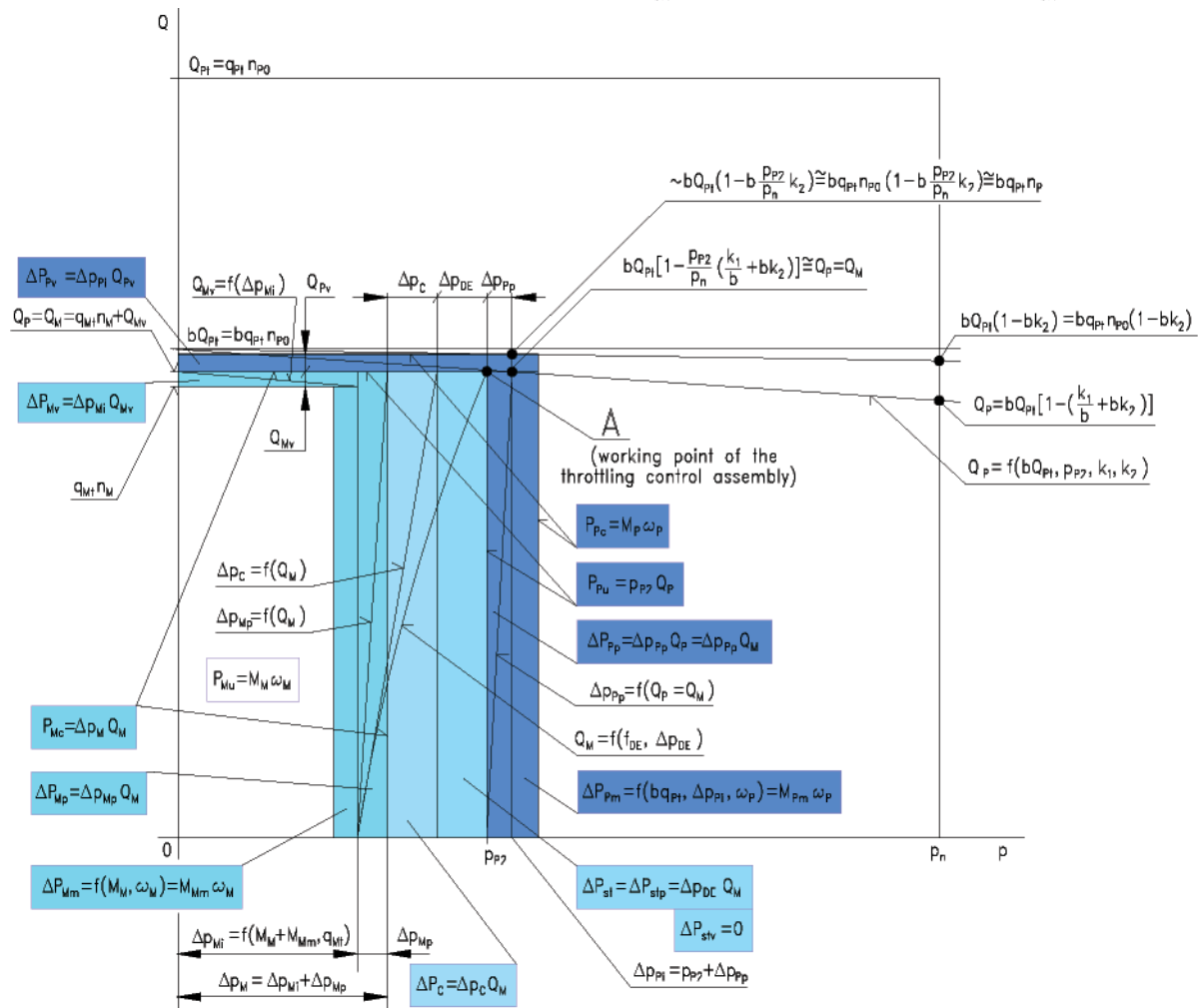

Fig. 11. Graphical interpretation of power losses in a hydrostatic drive and control system elements. Individual system with rotational hydraulic motor speed series throttling control fed by a variable capacity pump cooperating with the *Load Sensing* regulator in a variable pressure system: $p = \text{var}$ (coefficient „ a_1 ” of pressure increase in the regulator $a_1 = 0$); the series throttling control assembly in the form of:
1. servo-valve, 2. proportional directional valve, 3. set throttling valve, 4. set two – way flow regulator

range $0 \leq \omega_M \leq \omega_{Mmax}$ of its speed with the energy efficiency η only slightly lower than the efficiency η of a volumetric control system (directly by a variable capacity pump). The difference between overall efficiencies η of both systems will be inversely dependent on the capability of increase of the area of throttling proportional valve (or throttling valve) slot f_{DEmax} . The increase of f_{DEmax} allows to decrease $\Delta p_{DEmin} \approx 0$ at a maximum flow intensity $Q_{Mmax} = Q_{Pmax}$ (i.e. equal to a full pump capacity). It also requires correct operation of the pump LS regulator adjusting, in the whole range $0 \leq Q_p \leq Q_{Mmax}$ of the pump capacity, the discharge pressure p_{p2} at the level higher by a value $\Delta p_{LS} = p_{p2} - p_2 = cte$ then the p_2 pressure in the discharge conduit from the throttling proportional control valve (throttling valve) to the hydraulic motor.

To be continued in the next issue

BIBLIOGRAPHY

1. Paszota Z.: *Aspects énergétiques des transmissions hydrostatiques*, Monograph, 2002
2. Paszota Z.: Model of losses and efficiency of an energy – saving hydraulic servomechanism system, Marine Technology Transactions, Polish Academy of Sciences, Branch in Gdansk, Vol. 18, 2007
3. Paszota Z.: *Energy saving in a hydraulic servomechanism system*, Proc. 17th Symposium on Theory and Practice of Shipbuilding in memoriam prof. Leopold Sorta, Opatija, 19 – 21 October 2006
4. Skorek G.: *Energy characteristics of the hydraulic systems with proportionally controlled cylinder fed in a constant or variable pressure* (in Polish), Doctor dissertation, Gdansk University of Technology, continuation
5. Paszota Z.: *Energy Saving in a Hydraulic Servomechanism System – Theory and Examples of Laboratory Verification*, Brodogradnja, Journal of Naval Architecture and Shipbuilding Industry, Vol. 58, No 2, Zagreb, June 2007
6. Paszota Z.: *Hydraulic Servomechanism System. Examples of Reduction of Power Losses in the Variable Pressure Power Supply*, International Scientific – Technical Conference “Hydraulics and Pneumatics’2007”, Wrocław, 10 – 12 October 2007
7. Paszota Z.: *Power of energy losses in the hydrostatic drive system elements – definitions, relations, range of changes, energy efficiencies*. Part I – Hydraulic motor. Chapter in the monograph: „*Research, design, production and operation of hydraulic systems*” (in Polish), Andrzej Meder and Adam Klich editors. „Cylinder” Library. Komag Mining Mechanisation Centre, Gliwice 2007
8. Paszota Z.: *Power of energy losses in the hydrostatic drive system elements – definitions, relations, range of changes, energy efficiencies*. Part II – Conduits, throttling control assembly, pump. Chapter in the monograph: „*Research, design, production and operation of hydraulic systems*” (in Polish), Andrzej Meder and Adam Klich editors. „Cylinder” Library. Komag Mining Mechanisation Centre, Gliwice 2007
9. Paszota Z.: *Power of energy losses in the hydrostatic drive system elements – definitions, relations, range of changes, energy efficiencies* (in Polish). Part I – Hydraulic motor. Napędy i sterowanie, scientific monthly, No 11 (103), November 2007
10. Paszota Z.: *Power of energy losses in the hydrostatic drive system elements – definitions, relations, range of changes, energy efficiencies* (in Polish). Part II – Conduits, throttling control assembly, pump. Napędy i sterowanie, scientific monthly, No 12 (104), December 2007
11. Paszota Z.: *Graphical presentation of the power of energy losses and power developed in the elements of hydrostatic drive and control system* (in Polish). Part I – Rotational hydraulic motor speed series throttling control systems. To be presented at the Cylinder’2008 Conference in September 2008
12. Paszota Z.: *Graphical presentation of the power of energy losses and power developed in the elements of hydrostatic drive and control system* (in Polish). Part II – Rotational hydraulic motor speed parallel throttling control and volumetric control systems. To be presented at the Cylinder’2008 Conference in September 2008

CONTACT WITH THE AUTHOR

Prof. Zygmunt Paszota
Faculty of Ocean Engineering
and Ship Technology
Gdansk University of Technology
Narutowicza 11/12
80-952 Gdansk, POLAND
e-mail: zpaszota@pg.gda.pl



Photo: Cezary Spigarski