

How to choose drive's rated power in electrified urban transport?

Mikołaj Bartłomiejczyk¹, Slobodan Mirchevski², Leszek Jarzebowicz¹,
Krzysztof Karwowski¹

GDAŃSK UNIVERSITY OF
TECHNOLOGY

Faculty of Electrical and Control
Engineering, Narutowicza St. 11/12,
80-233 Gdańsk, Poland

E-Mail: mikolaj.bartlomiejczyk@pg.gda.pl

URL: <http://www.pg.edu.pl>

SS. CYRIL AND METHODIUS
UNIVERSITY

Faculty of Electrical Engineering and
Information Technologies, 1000 Skopje,
Republic of Macedonia

E-Mail: mirceslo@feit.ukim.edu.mk

URL: <http://en.feit.ukim.edu.mk/>

Keywords

«Urban electric vehicles », «Vehicle duty cycle », «Electric traction drives», «Control», «Energy efficiency»

Abstract

Selection of drive's rated power influences not only vehicle's dynamics, but also its energy efficiency. Mentioned above approach requires a multiphysical model, which covers both mechanical and electrical phenomena. This paper discusses how selection of traction drive's rated power influences vehicle energy consumption on example of a trolleybus. A complex mathematical model was developed in Matlab/Simulink to describe the multiphysical dependencies. Several driving scenarios were proposed to compare the energy consumption between trolleybuses equipped with medium- and high-power electric drive in different conditions. Numerical investigations reveal the possibility of gaining substantial energy savings using of the high-power drive.

Introduction

Movement of electrical vehicles in urban transport is cyclical, so load of traction drive can be also analyzed as a periodic function of time. Pattern of vehicle driving cycle can be divided into: acceleration, ride, coasting, and breaking until stop. Standard driving cycles for purposes of energy consumption comparison are defined by International Association of Public Transport (UITP) and named SORT – cycles. They are of trapezoidal shape and contain only stages of accelerating, riding with constant speed and breaking. Due to vehicle's congestion and influence of other vehicles, the duty cycle is often much more complex. This causes difficulties with setting requirements for traction drive system. The aim of International Electrotechnical Commission (IEC) is to promote cooperation on all matters concerning standardization in the electrical and electronic fields. However, the type of motor and efficiency of control are not considered as standards.

Selection of the right motor is an important issue, both from technical and economic point of view [1– 3]. It is worth to mention that specific duty cycles of urban electric vehicles make it difficult to define suitable power rating for the traction drive [4–9]. Practitioners typically prefer to select a typical motor's rating for a considered type and size of the vehicle. Increasing the rating is favorable to obtain better dynamics, especially when the vehicle accelerates on an uphill route. Nevertheless, motor oversizing causes increase in vehicle's manufacturing cost. Moreover, it can bring up concerns regarding possible decrease of energy efficiency, as an oversized drive for most time operates with relatively low load, i.e. in lower efficiency region. Therefore, traction drive's rating should be preceded with thorough analysis, which includes representative duty cycles. The analysis should include the motor's and power converter's losses, as well as all vehicle resistive forces [6,10,11].

The aim of the paper is to analyze how selection of traction drive's rated power influences vehicle's energy consumption. The analysis, carried out on example of trolleybus system in a Polish city of Gdynia, includes two power variants – typical (medium) power and increased (high) power.

Speed profiles in urban transport

The movement of urban electric vehicles is quasi-cyclical. The length of each cycle depends on the location of stops and intersections. Moreover, the drive cycle may not consist of all the elementary driving phases. Thus the following types of cycles can be considered:

- forced riding, where there are only start-up and braking phases. It is used for travelling at short distances between stops;
- ride including coasting, i.e. consisting of: start – relatively long run without propulsion – braking. Its cycle is often considered beneficial for minimizing energy consumption;
- ride including constant velocity interval, i.e. cycle consisting of: start – driving at a constant speed – braking;
- ride with a quasi-constant speed performed by cyclical switching the drive on and off.

A trolleybus or e-bus, in contrast to rail vehicles, does not have dedicated lanes and moves along the road with other vehicles. Hence, a trolleybus' movement is influenced by other road users. Moreover, the number of speed limits on the road is bigger than in the case of railway traction. A frequent approach applied by trolleybus' drivers is to repeat starting and coasting phases several times during one cycle (Fig. 1), which causes the vehicle to ride with quasi-constant speed.

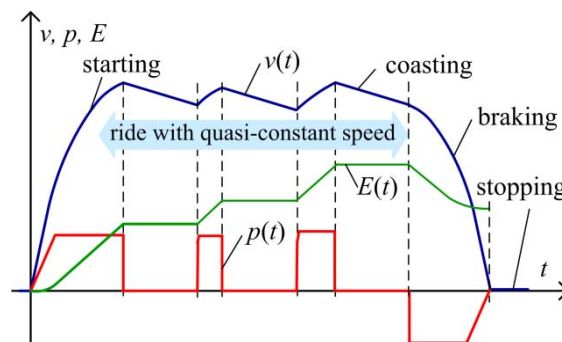

Fig. 1: Typical driving cycle of a trolleybus – speed v , drive's power p and consumed energy E

In actual conditions, the movement of trolleybuses is influenced by many factors with a random character. In addition, drive's torque is set using the acceleration pedal, which makes it difficult to maintain a constant speed. Consequently, the waveforms of speed and power consumption of the vehicle have a more complex shape. Fig. 2 is an example of actual driving cycle of a trolleybus. The ride presented in Fig. 2a is close to the pattern of ride including constant velocity interval, while the one in Fig. 2b may be categorized as a ride with a quasi-constant speed.

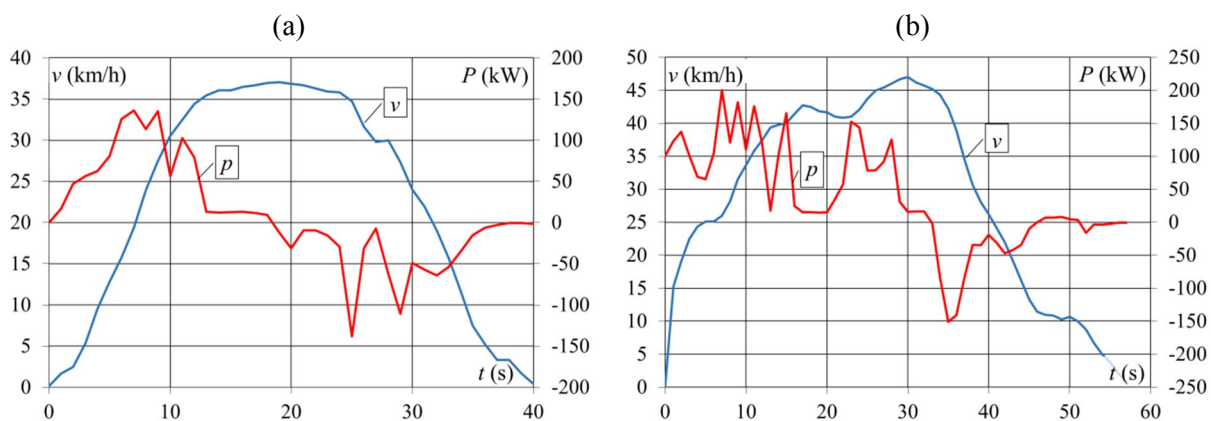

Fig. 2: Examples of driving cycles recorded with 1-second intervals in a running trolleybus: ride including constant velocity interval (a); ride with a quasi-constant speed (b)

Power conversion in vehicle's variable speed drives

Trolleybuses are supplied through an overhead supplying wires and twin current collectors (Fig. 3) [5,12]. Optionally, they are equipped with a battery pack that allows to travel autonomously at short distances, e.g. in case of supplying system failure. Most presently manufactured trolleybuses consist of three-phase induction motor. The DC supplying voltage is therefore converted to three-phase AC voltage by a power electronic converter. The converter typically consists of IGBTs, as the supplying voltage is at a level to few hundreds volts [10]. MOSFETs are preferred for low voltage applications. To the contrary, GTOs and thyristors are common in high power vehicles like locomotives. A number of researches on SiC converters, which have superior efficiency, have been carried out [13].

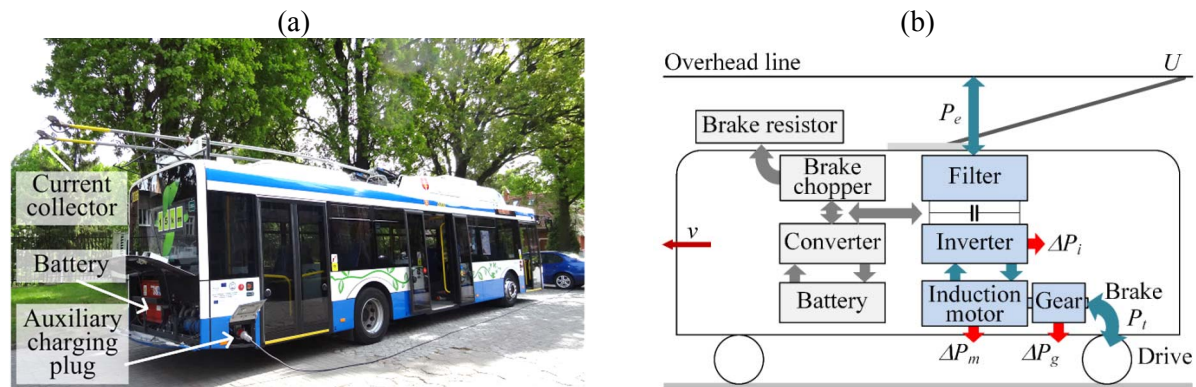

Fig. 3: Trolleybus: hybrid trolleybus supply from overhead line or battery (a); power flow in the drivetrain (b)

Power converters produce the output voltages based on pulse width modulation (PWM), which uses multiple transistors switching within each modulation cycle [14]. As a result, the motor's line-to-line voltages change in a rectangular manner, but their mean over modulation period matches the reference voltage set by the control algorithm. This way motor currents are quasi sine-shaped, as presented in Fig. 4. The superimposed ripple component is strictly related to the duration of PWM cycle; hence, high PWM frequencies are desirable to minimize the ripples. On the other hand, higher PWM frequency corresponds to increased switching losses. As a result, power converters designed for trolleybuses typically use IGBT-based power converters with a PWM frequency at a level of 2 kHz.

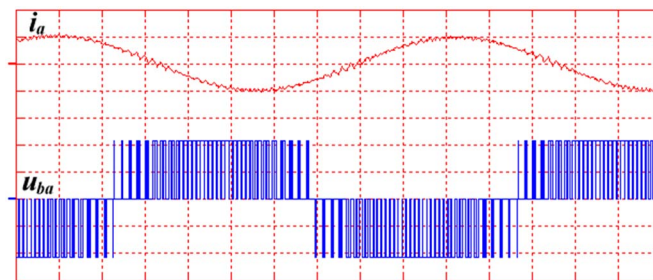

Fig. 4: Selected motor phase current and line-to-line voltage in AC motor

In order to provide precise regulation of motor's torque, vector control methods, such as Field Oriented control (FOC), are applied [10, 15]. These methods enable a wide speed regulation with respect to voltage, current, power, and slip constraints (Fig. 5). In electric vehicles, at least two speed regions of torque control are present, i.e. constant torque and constant power regions. The third region shown in Fig. 5, associated to constant slip, is optional.

Efficiency of electric motor depends on the operating point. It should be noted that in general the efficiency increases with generated torque and with rotor speed. Thus, oversizing of the motor may result in decreasing overall efficiency, as it causes the drive to operate at relatively low torque [7–10].

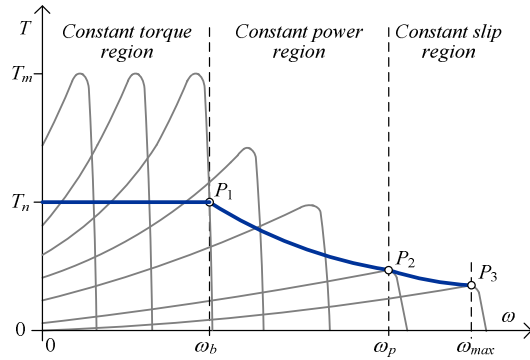

Fig. 5: Torque vs. speed graph for a vector controlled vehicle's induction motor drive

Simulation model

In order to evaluate trolleybus' electric energy consumption a simulation model was developed in Matlab/Simulink (Fig. 6). The model reflects a trolleybus' dynamics as well as electromechanical power conversion. To accurately compute the power losses (ΔP_i , ΔP_m , ΔP_g in Fig. 3b), the model includes detailed subsystems related to electric motor, power converter, and drive's control algorithm. Exemplary waveform of motor electrical variables obtained with the model were presented in Fig. 4.

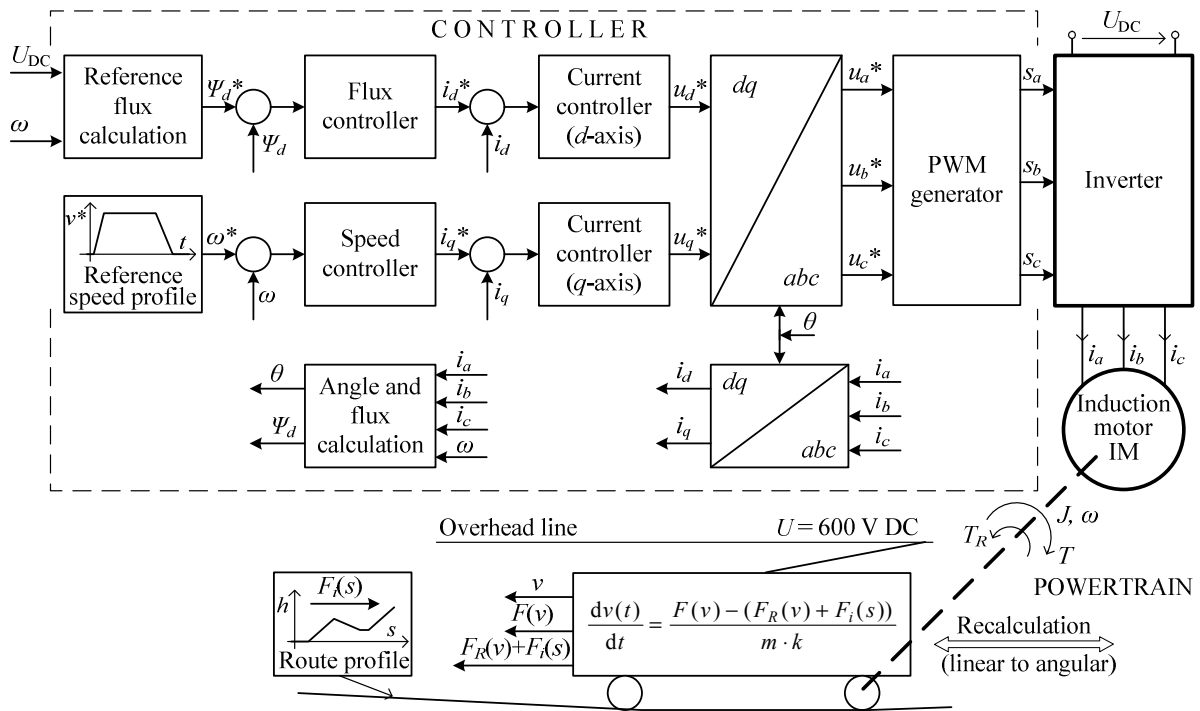

Fig. 6: General structure of simulation model for evaluating energy consumption

The model is set up according to parameters of an exemplary 12-meter long trolleybus. The net weight of the vehicle is 13200 kg, and the maximal mass of its passengers is 4800 kg. The model reflects vehicle's resistive forces F_R due to air drag and friction. The function $F_R=f(v)$ was derived experimentally and approximated by a quadric function. Moreover, the model computes additional forces associated to the route grade based on a preprogrammed vertical profile of the route $i=f(s)$ and a weight of the vehicle.

Two variants of traction motors are considered (Table I). The medium-power motor, rated for 175 kW, is a typical motor applied to the considered vehicle. The high-power motor, rated for 240 kW, is an optional variant provided by a manufacturer. The motor is supplied by an inverter whose parameters are given in Table II. Equivalent circuits of motor and inverter are included in the model and parametrized according to manufacturers' provided parameters.

The electric drive control is based on Field Oriented Control algorithm, including voltage and current constraints [16]. Two control regions are reflected – constant torque and constant power (Fig. 5). A speed controller was added to model the driver’s behavior. This controller is provided with a speed profile set accordingly to a particular test scenario, which is explained later.

The outputs of the model include tractive power $P_t(t)$, power losses in the drivetrain $\Delta p(t)$, input (electrical) power $P_e(t)$. The drive efficiency is computed as $\eta = P_t/P_e$. Respective energies are computed by integrating the power waveforms.

Tractive force vs. trolleybus speed graphs derived from the considered drivetrains using the developed model are shown in Fig. 7. The curves show the maximal tractive force as well as the force reduced to 66% and 33%. Drive efficiency values, including losses in the motor, inverter and gear, are given for selected operating points [10,17,18].

Table I: Parameters of considered induction motors and their equivalent circuits

Parameter	Medium-power motor	High-power motor
Rated torque T (Nm)	1660	2350
Rated power P (kW)	175	240
Rated frequency f (Hz)	60	60
Rated line-to-line stator voltage U_{rms} (V)	400	400
Nominal current I_s (A)	312	444
Number of poles p	6	6
Stator resistance R_s (m Ω)	12	6.6
Rotor resistance R_r (m Ω)	10.7	5.7
Core-losses equivalent resistance (Ω)	93.19	63.54
Magnetizing inductance L_m (mH)	5.59	3.0
Stator leakage inductance $L_{\sigma s}$ (mH)	0.21	0.14
Rotor leakage inductance $L_{\sigma r}$ (mH)	0.2	0.13

Table II: Power electronic inverter’s parameters

Type of the inverter	IGBT power module, 2-level, 3 legs
Power P (kW) – nominal/max	240/290
PWM frequency f_{PWM} (kHz)	2
Continuous DC forward current I (A)	650
Transistors forward voltage V_F (V)	1.7



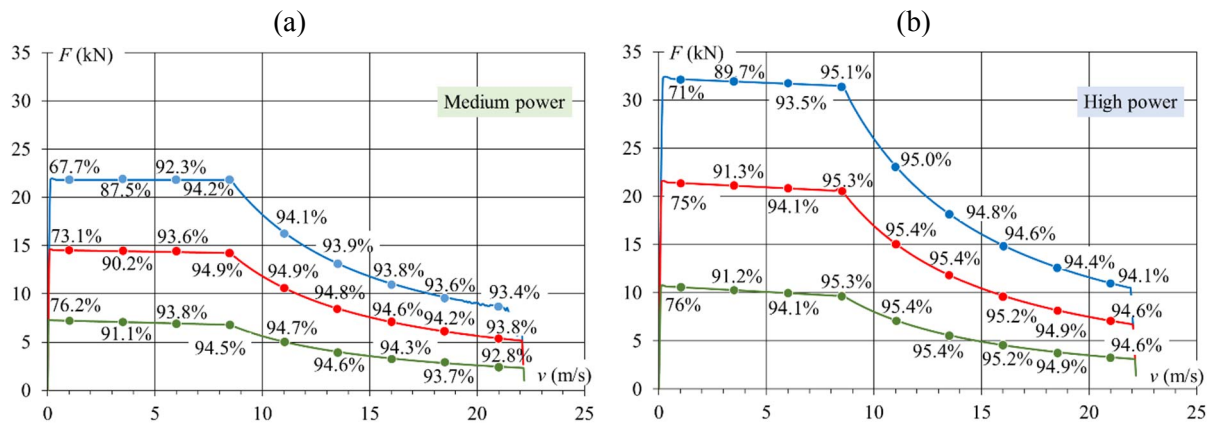

Fig. 7: Torque vs. speed graphs of the considered traction drives with efficiency values marked for selected operating points: (a) medium-power drive; (b) high-power drive

Exemplary results of simulating a ride

Exemplary results are provided to present the general methodology applied in the next section. For this purpose, two theoretical rides between two stops were considered – one for medium-power and one for high-power trolleybus. The medium-power trolleybus accelerated according to its maximum tractive force vs. speed curve; reached nearly its maximal speed; and braked according to the maximum force curve. The high-power trolleybus also used its full power to accelerate and brake, but its speed profile was amended with a constant-speed interval. This interval duration and speed value was selected empirically to obtain the same distance and time as in the case of medium-power trolleybus. This way, both trolleybuses covered the same distance in the same time T . It was assumed that all power gained from the regenerative braking can be transferred to another vehicles or stored in on-board battery, i.e. none energy is dissipated in the braking resistor.

The results of the exemplary simulations are presented in Fig. 8 and 9. The values were normalized in order to make the comparison easier. Due to higher acceleration and deceleration, the maximal speed of the high-power trolleybus is approximately 25% lower than that of the medium-power one. As the resistive force F_R is proportional to speed, the high-speed trolleybus ride requires less tractive energy E_t to cover the same distance in the same time. Similar relation applies the electrical energy E_e , which is computed as tractive energy increased with the energy lost in the drivetrain.

In Fig. 10, a comparison of drive's efficiency and drive's power losses is presented. The power losses were normalized according to the rated drive's power, i.e. 175 kW or 240 kW.

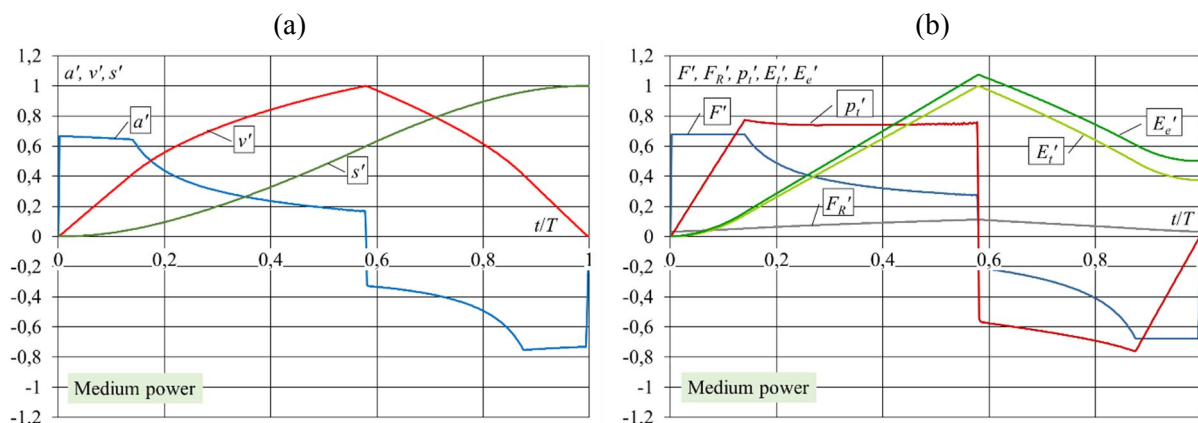

Fig. 8: Exemplary simulation results of medium-power trolleybus ride in per-unit values: relative values of acceleration, velocity and distance (a); relative values of tractive power, tractive and resistive forces, and tractive and electrical energy (b)

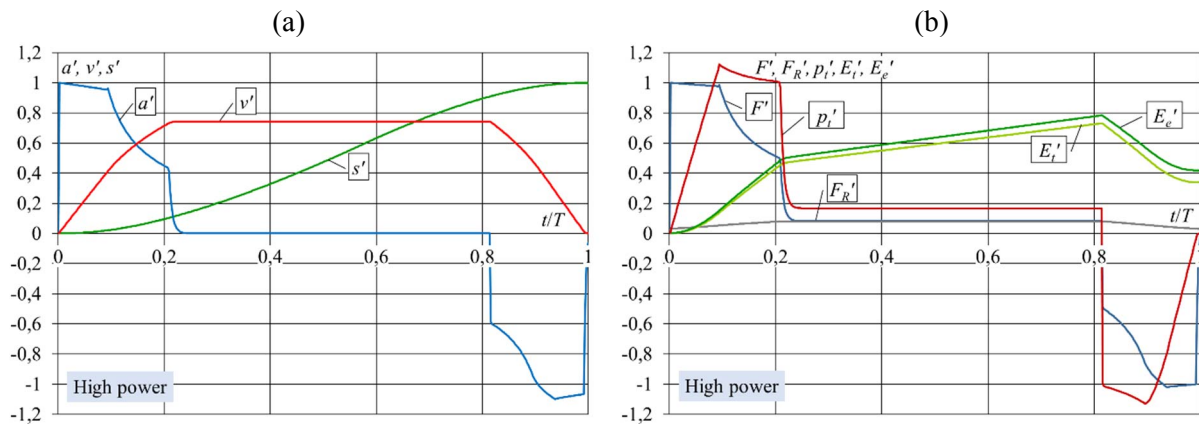

Fig. 9: Exemplary simulation results of high-power trolleybus ride in per-unit values: relative values of acceleration, velocity and distance (a); relative values of tractive power, tractive and resistive forces, and tractive and electrical energy (b)

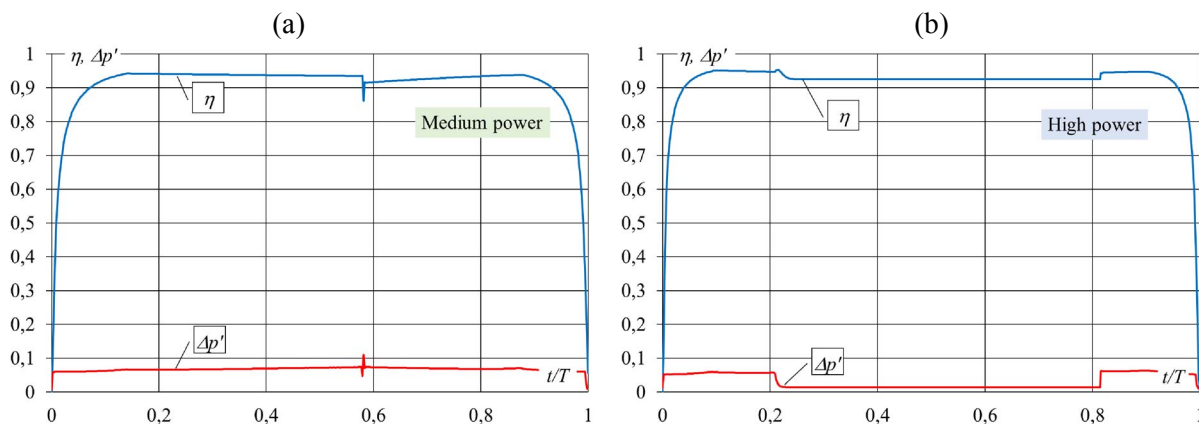

Fig. 10: Exemplary simulation results – efficiency and relative power loss of the drive of trolleybuses: equipped with 175-kW drive (a); equipped with 240-kW drive (b)

Trolleybus' energy consumption analysis

In order to compare the energy effectiveness of a trolleybus in two considered variants of drive's rated power, a series of simulations was carried out. The simulations modeled a ride between two stops. The simulations were repeated for different conditions, which were selected based on analysis of the trolleybus system in Gdynia, Poland. These conditions are:

- different travelling distance between stops: 300 m and 600 m; the values correspond to the shortest and the longest distance between subsequent stops in Gdynia,
- different load: 100% passengers and 20% passengers;
- different road grade: 0%, 8% and -6%; the uphill and downhill grades were selected according to the maximal values in Gdynia.

The simulation was provided for each possible set of the above variants. For each case, first the simulation of medium-power trolleybus was provided. The trolleybus accelerated with full available power, run with constant speed of 50 km/h, and braked with full power. The instant where braking starts was selected empirically to stop at the assumed distance (300 or 600 m). In some cases, especially during the uphill rides on 300-meter distance, the trolleybus did not reach a speed of 50 km/h; then, it performed the forced riding pattern. Next, the simulation of high-power trolleybus was performed in a similar manner, but the constant speed value as well as instant where braking starts, were selected to obtain the same travelling distance and time as for the medium-power trolleybus. The summary of all simulations is included in Table III. Selected results are additionally presented in Fig. 11, Fig. 12 and Fig. 13. The outputs include: electrical energy at the end of ride E_e (including the energy recovered during braking), maximal value of electrical energy E_{e-max} , energy lost due to the drivetrain losses ΔE . Additionally, an

index Q was computed, which indicates the difference between electrical energies (E_e) obtained for medium- and high-power trolleybuses.

Table III: Summary of energy consumption analysis

Trolleybus load	Route grade	Drive's rated power	Energies summary for 300-meter distance between stops				Energies summary for 600-meter distance between stops			
			E_e (MJ)	E_{e-max} (MJ)	ΔE (MJ)	Q	E_e (MJ)	E_{e-max} (MJ)	ΔE (MJ)	Q
100% (full load)	$i = 0\%$	medium	0.93	2.17	0.31	+11%	1.71	2.89	0.37	+5%
		high	0.83	1.63	0.25		1.63	2.60	0.35	
	$i = 8\%$	medium	5.23	5.29	0.52	+3%	10.43	10.22	0.83	+5%
		high	5.09	5.06	0.38		9.88	9.94	0.61	
	$i = -6\%$	medium	-2.18	1.15	0.42	+8%	-4.48	1.15	0.56	+4%
		high	-2.35	0.63	0.29		-4.68	0.92	0.42	
20% (light load)	$i = 0\%$	medium	0.90	1.86	0.26	+10%	1.68	2.58	0.32	+5%
		high	0.81	1.47	0.22		1.60	2.36	0.31	
	$i = 8\%$	medium	4.34	4.58	0.42	+4%	8.55	8.58	0.68	+2%
		high	4.16	4.28	0.31		8.38	8.48	0.51	
	$i = -6\%$	medium	-1.55	0.99	0.33	+7%	-3.24	0.99	0.41	+3%
		high	-1.66	0.68	0.25		-3.35	0.88	0.35	

The overall energy consumption of traction propulsion consists two main elements: mechanical energy of the vehicle's movement and energy losses in traction propulsion system. The physical aspects of these elements are different, so their influence should be analyzed separately.

The mechanical energy of the movement depends on the driving profile shape. In this way it refers to issue of driving techniques and ecodriving. The basic parameter of movement with an impact on the use of energy is speed of vehicle. This is dictated by a physical aspect of movement and a character of urban road congestion. Moving around of a vehicle in urban conditions is related to the occurrence of cyclical, frequent start-ups and braking, in which the main part of energy flow is related to kinetic energy of vehicle. Its value is proportional to the square of speed. The other parameters of movement are of supplementary. An increase of movement dynamics allows limiting maximum speed, which ends in a decrease of energy consumption.

The energy lost in traction drive systems mostly depends on the parameters of electrical equivalent circuit of traction motor and converter. Increase of the rate power of electric motor means the decrease of stator and rotor resistance value. As a result, the energy losses are reduced.

Both elements of energy consumption are smaller in case of high power motor. Higher power of the motor gives a possibility to run with bigger dynamic. It leads to the reduction of the maximum speed and consequently the mechanical energy of movement. Besides, internal losses in the 240 kW motor are lower. It needs to be underline, that this is the analyses of speed profile of vehicle movement.

Nevertheless, the energy consumption of movement is more dependent from the technical drive technique of driver than rate power of the motor. In real conditions increasing of the traction motor doesn't automatically bring the reducing of energy consumption.

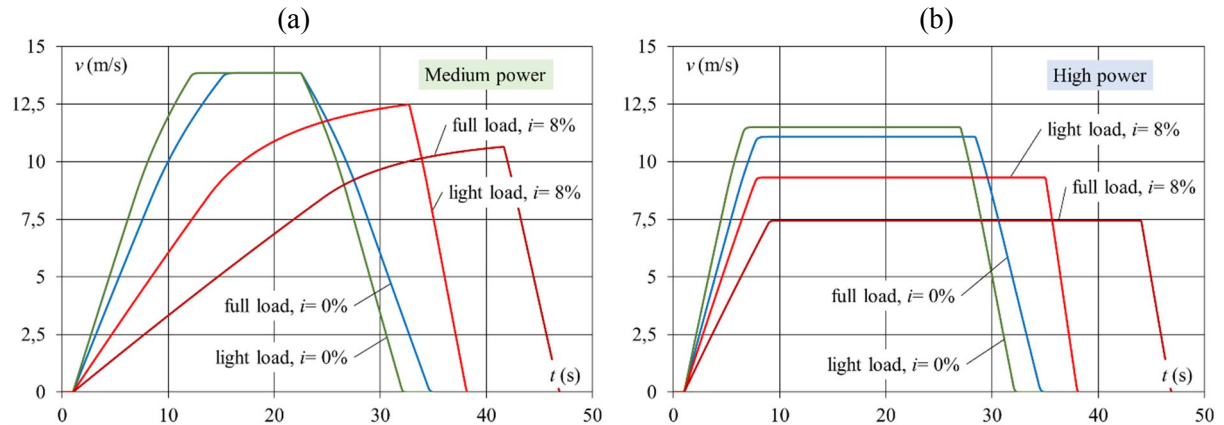

Fig. 11: Speed waveforms recorded during energy consumption analysis for 300-meter route: medium-power drive (a), high-power drive (b)

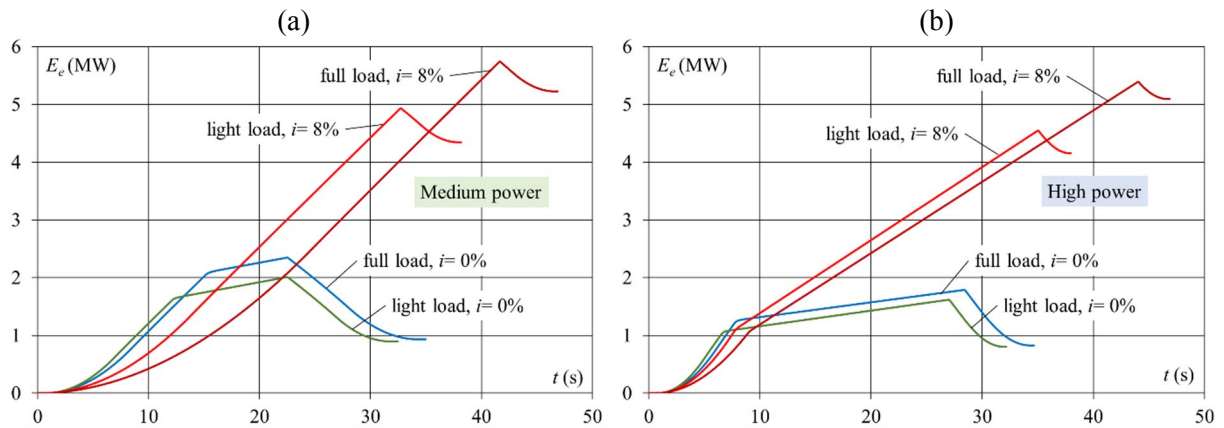

Fig. 12: Electrical energy waveforms recorded during energy consumption analysis for 300-meter route: medium-power drive (a), high-power drive (b)

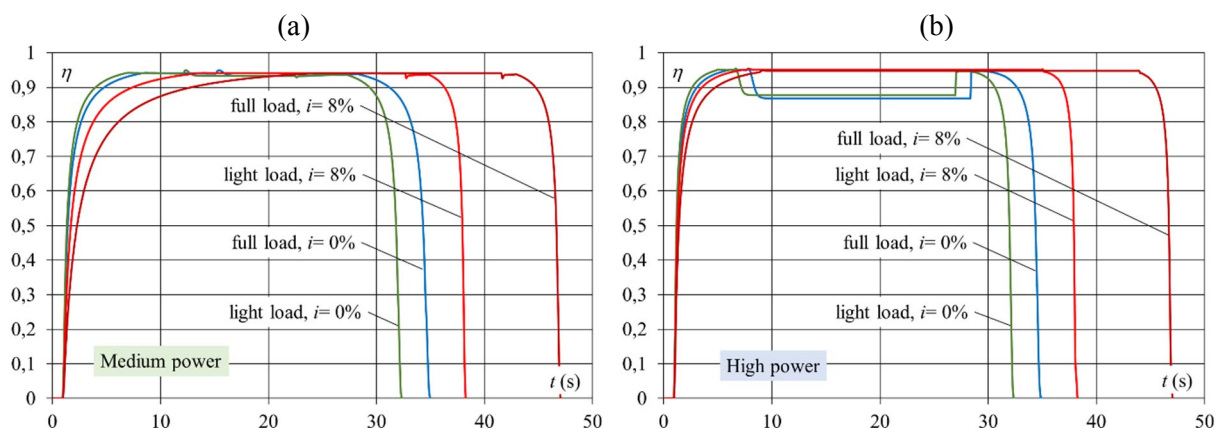

Fig. 13: Drive's efficiency waveforms recorded during energy consumption analysis for 300-meter route: medium-power drive (a), high-power drive (b)

Conclusion

The advantage of high power motor is mostly visible in case of short distance (300 m) and flat route. In this case the dynamic of the movement plays the biggest role. When distance between stops increases, the influence of power of traction motor became less important. It can be concluded, that optimal power depends on the route parameters. In analyzed case 175 kW traction motor is sufficient, but in situation of difficult character of transport route the high power motor allows to reduce energy consumption and enhance the driving parameters.

References

- [1] Mirchevski S.: Energy Efficiency in Electric Drives, Faculty of Electrical Engineering, ELECTRONICS, Vol. 16 No 1, June 2012, pp. 46-49
- [2] Weiller C., Neely A.: Using electric vehicles for energy services: Industry perspectives, Energy, vol. 77 (2014), pp. 194–200.
- [3] Orłowska-Kowalska T., Dybkowski M.: Industrial drive systems. Current state and development trends, Power Electronics and Drives, vol. 1 (36) no. 1, 2016, pp. 5–25.
- [4] Bartłomiejczyk M., Mirchevski S.: Reducing of energy consumption in public transport – results of experimental exploitation of super capacitor energy bank in Gdynia trolleybus system. Proc. 16th International Power Electronics and Motion Control Conference and Exposition, Antalya, 21-24 Sept. 2014.
- [5] Zhang D., Jiang J., Wang L. Y., Zhang W.: Robust and Scalable Management of Power Networks in Dual-Source Trolleybus Systems: A Consensus Control Framework, IEEE Transactions on Intelligent Transportation Systems, vol. 17 no. 4, 2016, pp. 1029–1038.
- [6] Szumanowski A.: Hybrid Electric Power Train Engineering and Technology – Modeling, Control, and Simulation, Engineering Science Reference, IGI Global, 2013.
- [7] Rajashekara K.: Present Status and Future Trends in Electric Vehicle Propulsion Technologies, IEEE Journal of Emerging and Selected Topics in Power Electronics, vol. 1, no. 1, 2013, pp. 3–10.
- [8] Kuhne R.: Electric buses, an energy efficient urban transportation means, Energy, Vol. 35 (2010), pp. 4510–4513.
- [9] Scarpellini S., Valero A., Lera E., Aranda A.: Multicriteria analysis for the assessment of energy innovations in the transport sector, Energy, vol. 57 (2013), pp. 160–168.
- [10] Abad G.: Power electronics and electric drives for traction applications. Wiley, 2017
- [11] Judek S., Skibicki J.: Evaluation of traction supply system electrical parameters for complex traffic condition using PSpice simulation program, Przegląd Elektrotechniczny, Vol. 85, Issue 12, pp. 270-273, 2009.
- [12] Maciolek T., Szelag A., Methods of reducing the negative influence of weather phenomena, icing in particular, on the operation of an overhead catenary, Rocznik Ochrona Srodowiska, Vol.18, pp 640-651, Part: 2, 2016.
- [13] Hruska M., Jara M.: High Efficiency and High Power Density Boost / Buck Converter with SiC JFET Modules for Advanced Auxiliary Power Supplies in Trolleybuses, Proc. PCIM Europe 2016, 10 – 12 May 2016, Nuremberg, Germany.
- [14] Jarzebowicz L.: Errors of a linear current approximation in high speed PMSM drives, IEEE Transactions on Power Electronics, vol. PP, no. 99, pp. 1–1, 2017. DOI: 10.1109/TPEL.2017.2694450.
- [15] Sahoo S. K., Bhattacharya T.: Rotor Flux-Oriented Control of Induction Motor With Synchronized Sinusoidal PWM for Traction Application, IEEE Transactions on Power Electronics, vol. 31 no. 6, 2016, pp. 4429–4439.
- [16] Jarzebowicz L., Karwowski K., Kulesza W.J., Sensorless algorithm for sustaining controllability of IPMSM drive in electric vehicle after resolver fault, Control Engineering Practice 58 (2017), pp. 117-126.
- [17] Demmelmayr F., Troyer M., Schroedl M.: Advantages of PM-machines compared to induction machines in terms of efficiency and sensorless control in traction applications. Proc. 37th Annual Conference on IEEE Industrial Electronics Society IECON, 2011, pp. 2762-2768.
- [18] Mahmoudi A.; Wen L. Soong; Gianmario Pellegrino; Eric Armando: Efficiency maps of electrical machines, Proc IEEE Energy Conversion Congress and Exposition (ECCE), 2015, pp. 2791 – 2799.

