

# INFLUENCE OF SOLID PARTICLE CONTAMINATION ON THE WEAR PROCESS IN WATER LUBRICATED MARINE STRUT BEARINGS WITH NBR AND PTFE BUSHES

Ewa Piątkowska

Gdańsk University of Technology, Poland

\* Corresponding author: [ewapiatk@pg.edu.pl](mailto:ewapiatk@pg.edu.pl) (E. Piątkowska)

## ABSTRACT

*This paper reports on a study of the influence of solid particle contamination on the wear process in water-lubricated slide bearings (steel-acrylonitrile-butadiene rubber (NBR) and steel-polytetrafluoroethylene (PTFE)). To compare the wear of the shaft journal and bushes (NBR and PTFE) when lubricated with fresh water and contaminated water, an experiment was carried out to identify key factors that influence the state of wear of slide bearing. The amount of wear was checked by means of geometric structure measurements on the journals, namely, roughness profile measurements using both a contact profilometer and an optical microscope. The obtained results enabled correlations between the material comprising the sliding sleeve, roughness of the journals and contamination inside the water-lubricated slide bearings.*

**Keywords:** water lubrication, solid particles contaminations, wear, strut bearings, plain bearings (NBR and PTFE)

## INTRODUCTION

To ensure acceptable and fault-free operation of a vessel and its propulsion system, it is necessary to constantly monitor the diagnostics of all the components. Water-lubricated slide bearings are elements highly prone to failure, especially when it comes to seawater-lubricated slide bearings in the shaft line of propellers in vessels. Their premature wear is one of the root causes of repairs to ships, which then leads to downtime and an increase in operational costs. Given these circumstances, the selection of the correct type of slide

bearing and an investigation of the impact of lubricants (e.g., contaminated water) on the wear process is crucial.

Special consideration should be given to the working conditions of the propeller shaft strut bearings (Fig.1). It is common to utilize bearings lubricated with seawater that surrounds the hull of vessels, where there is not control of the water flow and the water is not filtered. Therefore, when a vessel is operated in shallow or inland waters, various types of contaminants tend to enter the friction zone, resulting in accelerated wear processes.



Fig.1. Propeller shaft strut bearings [1]

Recent research in the literature deals mostly with the impact of contamination on oil-lubricated slide bearings. Due to the addition of various metallic particles, metal oxides, sulfides, carbon and other chemical compounds, such lubricating oils have a positive influence on the tribological properties of the bearings; the mentioned additions also increase the eco-friendliness of the oils [2]. Research was conducted on surfactant bearing lubricants based on non-organic hybrid nanoparticles with an organic outer shell that could be added to lubricating oils. However, such agents are not stable enough to achieve a sufficient effect on the surfaces of bearings; an acceptable lubrication is a combination of many contributing factors [3]. Problems related to premature wear of the aft stern bearings are reflected in many publications and are related to their lubrication [4], [5] as well as factors influencing the efficiency of this lubrication, such as vibrations [6], [7] or the dynamics of the shaft movement [8], [9].

Throughout the last 100 years, extensive research has been carried out that proved the existence of a relationship between the size and concentration of solid particles in lubricating oils, thickness of an oil film, and wear and temperature of bearings [10]–[12]. Among many factors influencing wear of bearings, special consideration has been given to the relation between the shaft journal hardness and bush hardness [13], influence of the initial shaft roughness and texture of the bearings [14] hydrodynamic journal bearings may suffer serious performance issues due to contamination from moisture, dust, foreign particles and wear debris. This experimental study investigates the effect of surface texturing on the steady-state performance characteristics of highly-loaded journal bearings lubricated with a contaminated lubricant. Special attention is given to the bearings' load capacity and friction and wear at various contamination levels in the lubricant. Rig tests have been performed at selected speeds and loads on plain smooth and surface-textured journal bearings. Variable-size test dust was introduced into the lubrication system (at different rates).

A different kind of research focused on diameter wear, weight loss of the pin, morphology of the worn elements, surface roughness changes, the oil film thickness and friction coefficient for different slip velocities. The parameters were

measured with tribotesters: e.g., ball on disc [15], block on ring [16], cylinder on disc [17]–[19] and pin on disc [20], [21].

The subject of water-lubricated bearings is not very popular in the literature; however, it is still under research. It is unlikely that lubrication-aiding additions could be found in seawater. Instead, typical waters where vessels are operated are quite contaminated, often by contaminants of natural origin, such as sand particles. This is why the propulsion system of vessels, especially propeller shaft bearings, is prone to seizing, damage and extensive wear and tear, which makes replacement of worn parts necessary.

Research of Baltic Sea pollution dealt with the influence of various factors on the concentration and spatial distribution of sediment delivered by rivers [22], concentration and size of solid particles in the aforementioned sediments [23], water salinity, and the temperature and turbidity throughout the seasons [24]. Also, mineral and geochemical diversity of surface sediments [25] and routes for sediment material transport from the rivers of the Baltic Sea and North Sea basin to the deposit basin of the Baltic Sea have been considered [26].

Contamination in the stern bearing of the shaft line of a ship significantly deteriorates the tribological and lubricating properties of friction pairs and may cause serious failures related to the propulsion system of the ship. Based on tests carried out with a tribotester and contaminated water, dependencies were found that could be used to select the optimal operating parameters to minimize the intensive wear of the shaft line slide bearings in a ship. The research activities undertaken by the author [27] took into account a number of different operating parameters, such as loads, sliding velocities and size and concentration of solid particles. They showed that with increasing load and sliding speed, the coefficient of friction and weight loss decrease, while their intensification occurred with an increasing degree of contamination in the water. Other researchers also determined that the above factors increase wear of bearings lubricated with contaminated liquids and pointed to slightly different dependencies: they observed an increase in wear and an increase in surface roughness with increasing sliding velocity, applied load and particle concentration [28] and an increase in the coefficient of friction and the amount of wear with an increase in the applied load and grain size [29].

In order to improve the tribological properties of water-lubricated marine stern bearings, various bearing materials and their textures are increasingly being investigated [30]–[34].

Even though the tests of water-lubricated plain bearings containing solid particles were carried out with the use of tribotesters, their results may constitute important indications for the method of conducting tests on a real object.

## TEST METHODS AND WORKING CONDITIONS

To minimize the risk of failure caused by unfavorable operating conditions in the form of lubricating a sliding node

with a liquid containing solid particles, tests were carried out to identify the key parameters affecting the speed of the wear process of cooperating sliding elements. For this purpose, the existing stand for testing water-lubricated plain bearings was adapted and rebuilt in such a way that it was possible to reliably carry out bearing wear tests in water contaminated with solid particles. Figure 2 shows a diagram of the cross-section of the test stand.

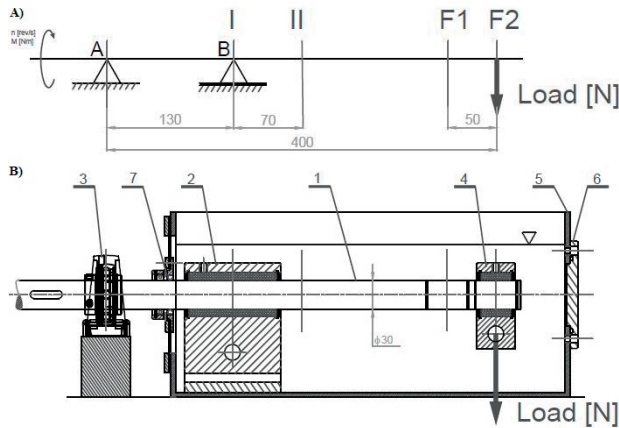

Fig. 2. Test stand description A) diagram of the stand and B) cross-section of the stand: 1 - shaft, 2 - tested bearing in a self-adjusting support, 3 - rolling bearing, 4 - slide bearing through which the load is exerted, 5 - tank filled with water, 6 - cover, and 7 - sealing

A three-phase electric motor was connected to a 30 mm diameter shaft by a torsionally flexible coupling. The shaft (1) was supported on two bearings: a self-aligning roller bearing (3) and a slide bearing located in the self-adjusting support (2), which allows the shaft to freely position in the slide bearing bush during bending. The shaft was partially located in the tank (5) filled with fresh water, which was the medium that lubricated the tested bearing. At its end, the slide bearing was mounted in the housing (4) through which the load was exerted. At the end of the shaft at the bearing mounting point F, a frame was attached and loaded with a concentrated force that simulated a load with a ship propeller. In front of the tank, a rolling bearing was installed, whose task was to ensure

that the seal (7) and a sealed cover (6) are coaxial at the end of the tank. An assembly hole was made that also protected against undesirable leakage of water from the tank. Such an experimental test stand allowed for a controlled application of a bending load on the journal of the tested water-lubricated plain bearing.

The test was carried out on a shaft made of a typical high-alloy steel, namely, an acid-resistant chrome-nickel 1H18N9 used for ship shafts that operated with two types of bushings. The first material used for the research was a fluorinated polymer, namely, polytetrafluoroethylene (PTFE), also known as Teflon, while the second was acrylonitrile-butadiene rubber (NBR), commonly known as rubber. The lubricant was fresh water with a temperature of approximately 30°C. There was a focus on ensuring the same operating parameters: surface pressures in both pairs of bearings B and F, load with a concentrated force of 550 N at the bearing mounting point F, operating time, sliding velocity and the number of start-ups of the stand.

To ensure the same surface pressures while obtaining different values of stresses and bending moments, the length of the tested bearing bush in support B and the position of the supports both B (position I or II) and F (position F1 or F2) were manipulated. The above-mentioned parameters along with the lengths and positions of the bushings during individual measurements are shown in Table 1.

Measurements from A to D were made on solid shafts, two consecutive E and F measurements were made on hollow shafts; since the same position and length of the bushes was used as in the case of the solid shafts, different values of the bending stresses were obtained while maintaining the same surface pressure.

In both series, 6 measurements were carried out for each material under the same conditions, and the positions and lengths of the sliding sleeves were variable. The dose of contaminants supplied to the tank differed with respect to the concentration of solid particles in the water, as presented in Table 1. They ranged from 5 cm<sup>3</sup> to 25 cm<sup>3</sup>, which accounted for from 0.042% to 0.208% of solid particles in water. The concentration of solid particles in the water was changed to determine whether and to what extent the dose

Tab. 1. Measurement table

indication	data			bending		surface pressures		contaminants		
	bush length B	bush length F	position of support B and force F	Bending moment	stresses from the bending moment	in bearing B	in bearing F	particulate dose	average concentration of solid particles	participation in a given volume of water
-	mm	mm	-	Nm	MPa	MPa	MPa	cm <sup>3</sup>	ml/l	%
A – G	50	28	II, F1	82.4	32.55	0.641	0.654	15	1.25	0.125
B – H	57	28	II, F2	109.87	43.41	0.643	0.654	20	1.67	0.167
C – I	77	28	I, F1	120.86	47.75	0.640	0.654	5	0.42	0.042
D – J	87	28	I, F2	148.33	58.60	0.648	0.654	5	0.42	0.042
E – K	57	28	II, F2	109.87	73.52	0.643	0.654	10	0.83	0.083
F – L	77	28	I, F1	120.86	80.87	0.640	0.654	25	2.08	0.208

of contaminants in the water that lubricated the sliding node impacted the wear of the friction elements.

Figure 3 shows a photograph of solid particles in the form of sand - a natural material carried by one of the rivers of the Polish Pomerania that originates from the Radunia River. Figure 1 shows the percentage of particles of a certain size added to the lubricant in which the steel-PTFE and steel-NBR tested sliding connections were located. The concentration of solid particles presented in Diagram 1 constituted less than 97% of the contaminants identified in the sand sample. The remaining solid particles from 50-200  $\mu\text{m}$  were very rare and accounted for slightly more than 3%. Particles with a diameter of up to 2  $\mu\text{m}$  (approx. 42%) had the largest share in the sand sample used for the tests. About 23% are particles had a size between 2 and 4  $\mu\text{m}$ . The number of sand particles decreased as their diameter increased.

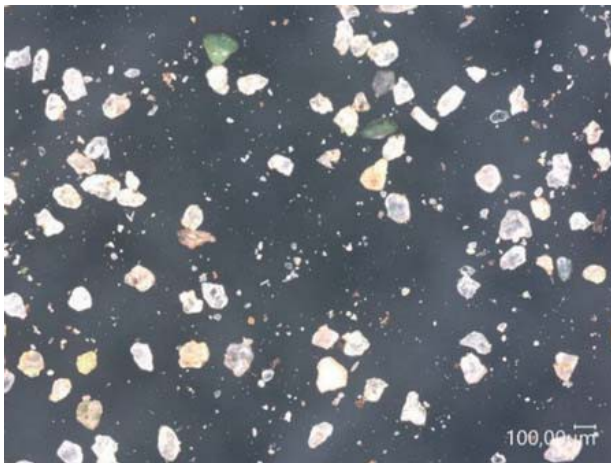

Fig. 3. Sand particles used in the research observed with a Keyence VHX-7000 optical microscope

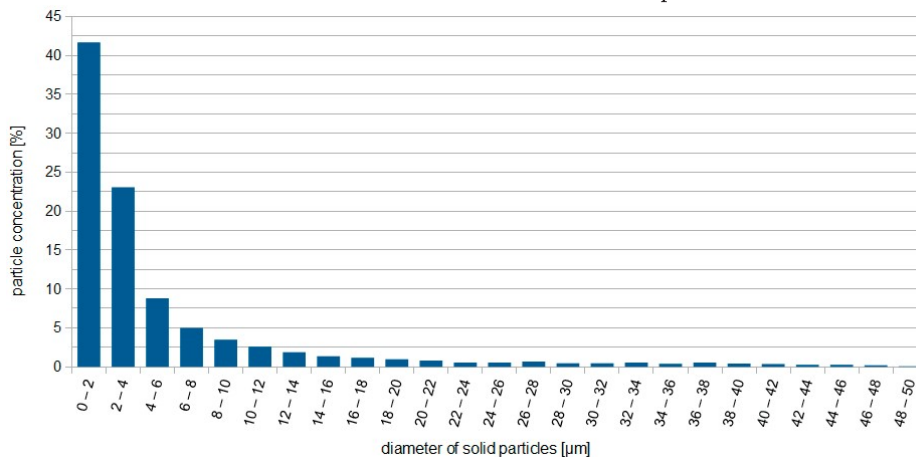

Diagram 1. Concentration of particles from the Radunia River considering their size

Each measurement of the sliding node followed the same procedure. For the first 10 hours, with two engine starts, the bearings were run-in and operated in contamination-free

water. Then, the dose of contaminants indicated in Table 1 was added, and the sliding couple worked for 16 hours when the research stand was started twice. After this time, the water was replaced and supplemented with the same amount of contaminants. This cycle was repeated three times. The total operating time of the bearings during one measurement was 58 hours, after which the bearings were dismounted, and the shaft journals were prepared for further activities related to the study of their geometric structure to identify the impact of contaminants on the wear of the water-lubricated sliding bearings.

## RESULTS AND DISCUSSION

The tests were carried out for sliding bushings made of NBR and PTFE operating both in fresh water and in contaminated water containing solid particles. After the experiment, the shaft journals with the bushings were subjected to visual wear assessment. Pictures of the surfaces of the journals are summarized in Table 2. In all cases, grooves are observed along the entire circumference of the journal; however, the condition of the journal surfaces lubricated with an agent containing solid particles indicates their more intensive exploitation.

On the surface of the journals cooperating with the rubber bushings one can also observe the predominant one-sided wear of the journal, namely, from the side where the load was applied due to the deflection of the shaft in the support. On the other hand, in the case of journals cooperating with PTFE bushings, the wear seems to be uniform along the entire length of the journal, indicating a more intense wear pattern on both edges.

The shaft journals operating in water devoid of solid particles are also noteworthy. While in the case of the

























harder material, PTFE, the wear differs slightly, and in the case of the more compliant material, NBR, the bushing material partially melted, transferred to the journal and filled the circumferential grooves due to an increase in the temperature of the lubricating fluid.

Thorough examinations of the journals were performed on a Jenoptik Hommel Etamic T8000 contact profilometer and a Keyence VHX-7000 optical microscope. The

measured roughness profiles (dependence of the roughness  $R_a$  [ $\mu\text{m}$ ] on the length  $L$  [mm] of the specimen) of the journals on the contact surface with the sliding sleeves showed a change in their roughness and material loss on the surfaces of the journals.



Tab. 2. Photographs of shaft journals cooperating with NBR and PTFE bushings in positions A-F in fresh and contaminated water conditions

		fresh water	contaminated water
<b>NBR</b>	<b>A</b>		
	<b>B</b>		
	<b>C</b>		
	<b>D</b>		
	<b>E</b>		
	<b>F</b>		
<b>PTFE</b>	<b>A</b>		
	<b>B</b>		
	<b>C</b>		
	<b>D</b>		
	<b>E</b>		
	<b>F</b>		

Tab. 3. Roughness profiles of journals cooperating with NBR bushings in positions A-F in fresh and contaminated water conditions obtained with a Hommel Etamic T8000 contact profilometer

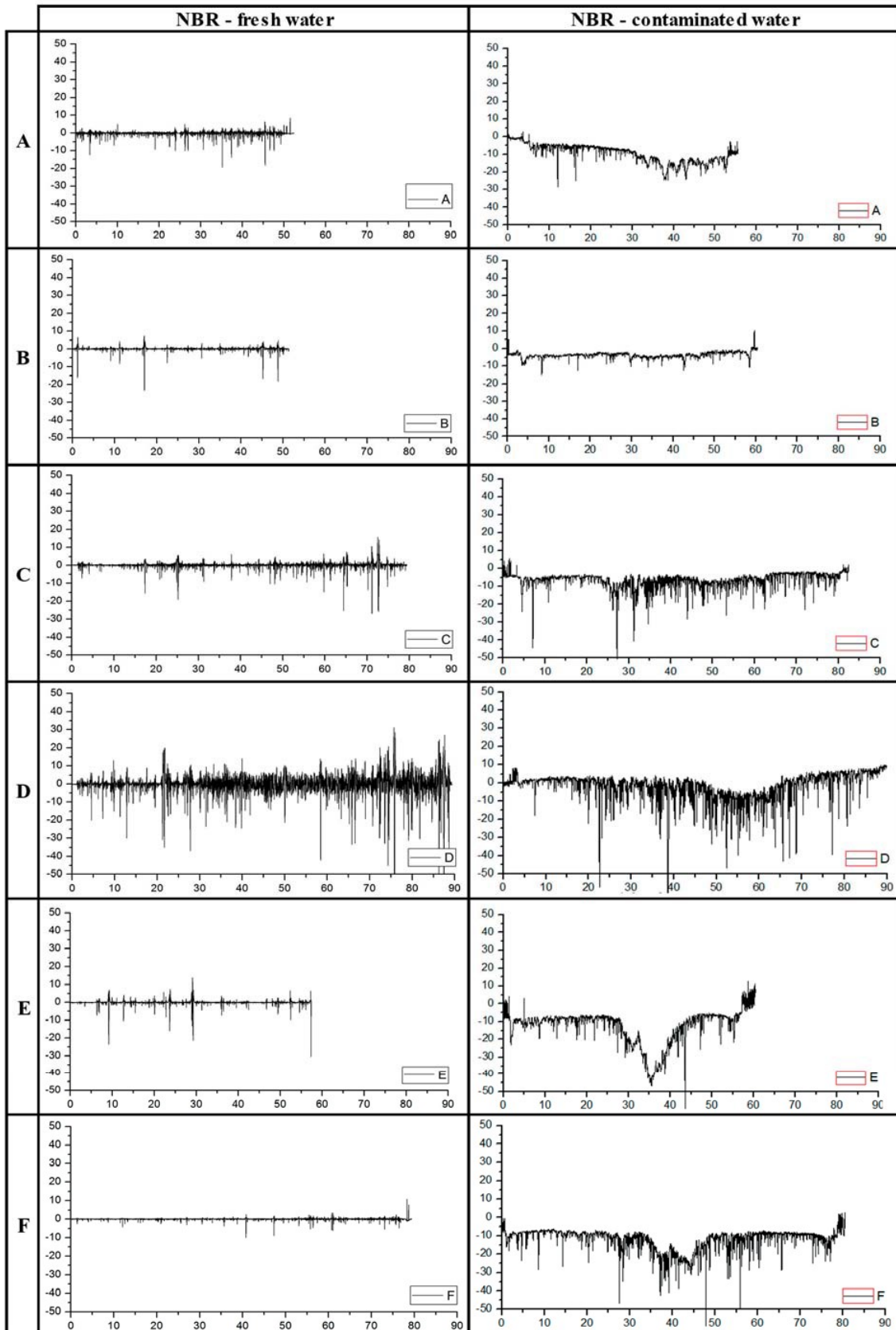

Tab. 4. Roughness profiles of journals cooperating with PTFE bushings in positions A-F in fresh and contaminated water conditions obtained with a Hommel Etamic T8000 contact profilometer

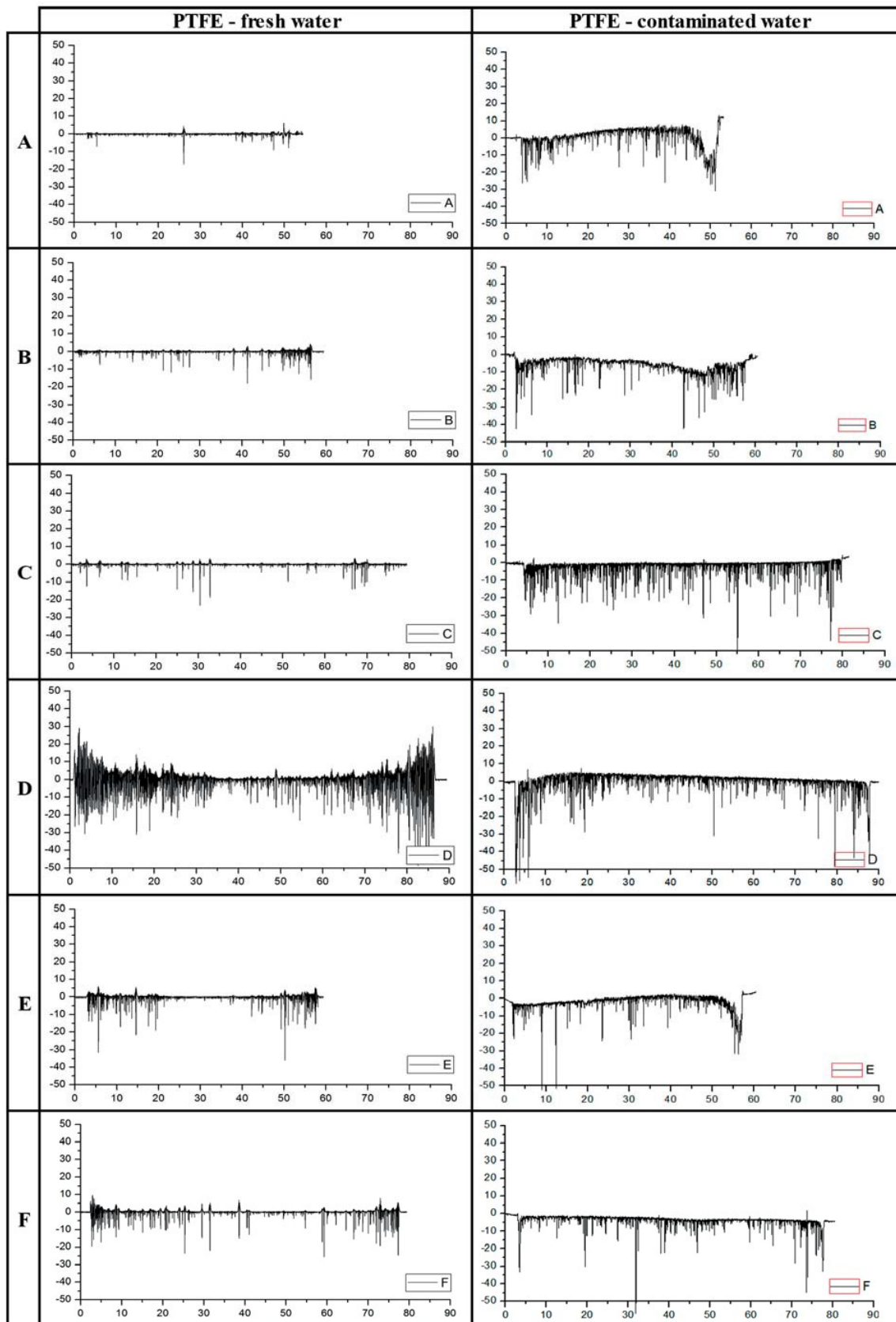

Tables 3 and 4 show the roughness profiles (Ra) of the shaft journals in the position of the self-adjusting support B (samples A-F) after cooperation with the NBR (Table 3) and PTFE (Table 4) sliding sleeves that were lubricated with fresh and contaminated liquids. The measurements were carried out using a contact profilometer.

After cooperation with PTFE, the journals, despite the visible shaft edging, were smoother and their profiles had a much smoother course. On the other hand, the journals that cooperated with the NBR bushings had a more diversified roughness profile and greater material losses were noticeable,

which indicates a more rapid wear process. There also was shaft edge bending, but it was less noticeable than with the PTFE.

Graphs of the roughness profiles made with an optical microscope are presented in Table 5 for the NBR bushings and Table 6 for the PTFE bushings. In this section, the profile of the roughness of the journals working only in contaminated water was limited because the bearings running in water without contamination had a much milder and more regular course.

Tab. 5. Roughness profiles of journals cooperating with NBR bushings in positions A-F in contaminated water conditions obtained with a Keyence VHX-7000 optical microscope

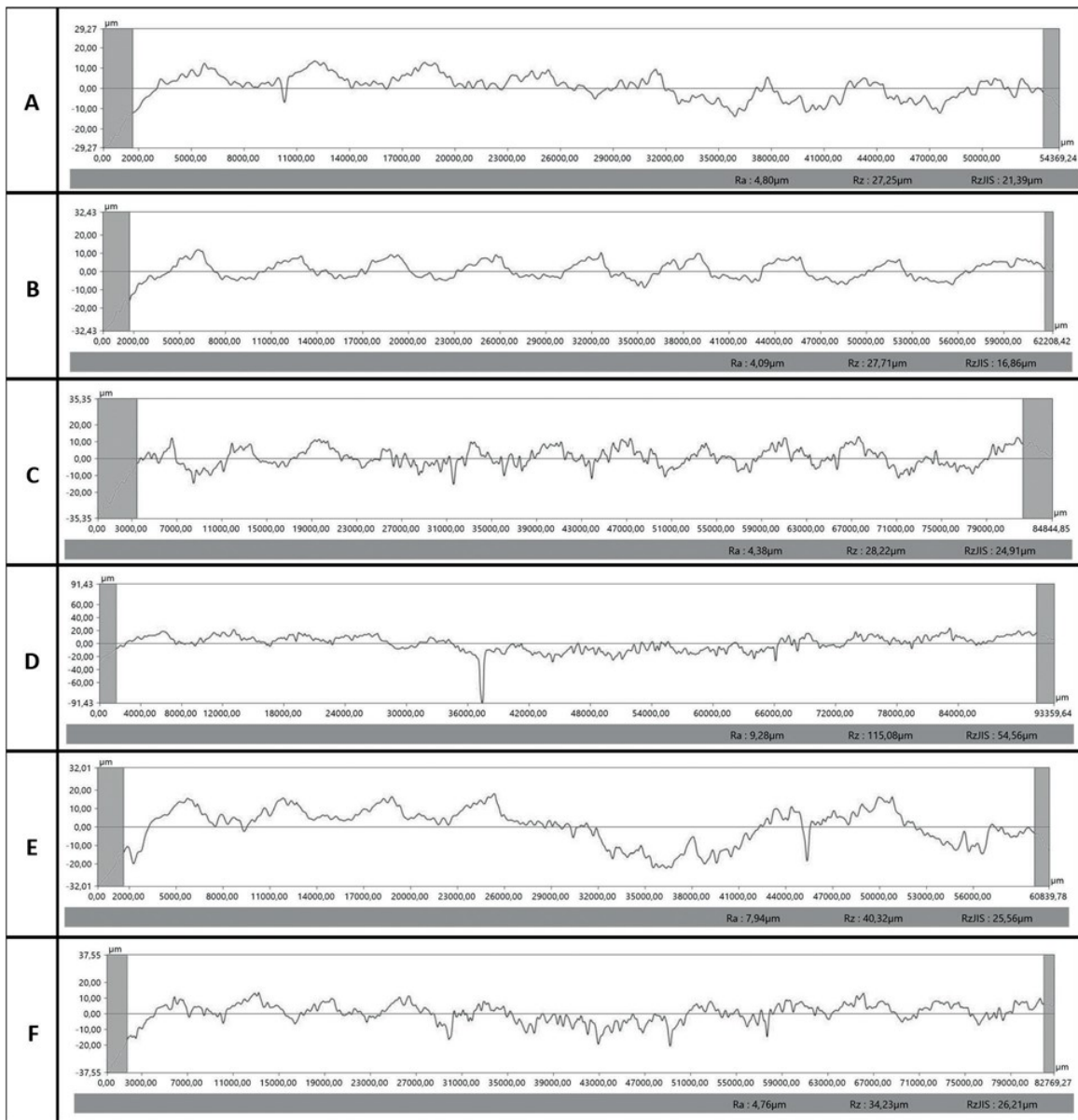



Tab. 6. Roughness profiles of journals cooperating with PTFE bushings in positions A-F in contaminated water conditions obtained with a Keyence VHX-7000 optical microscope

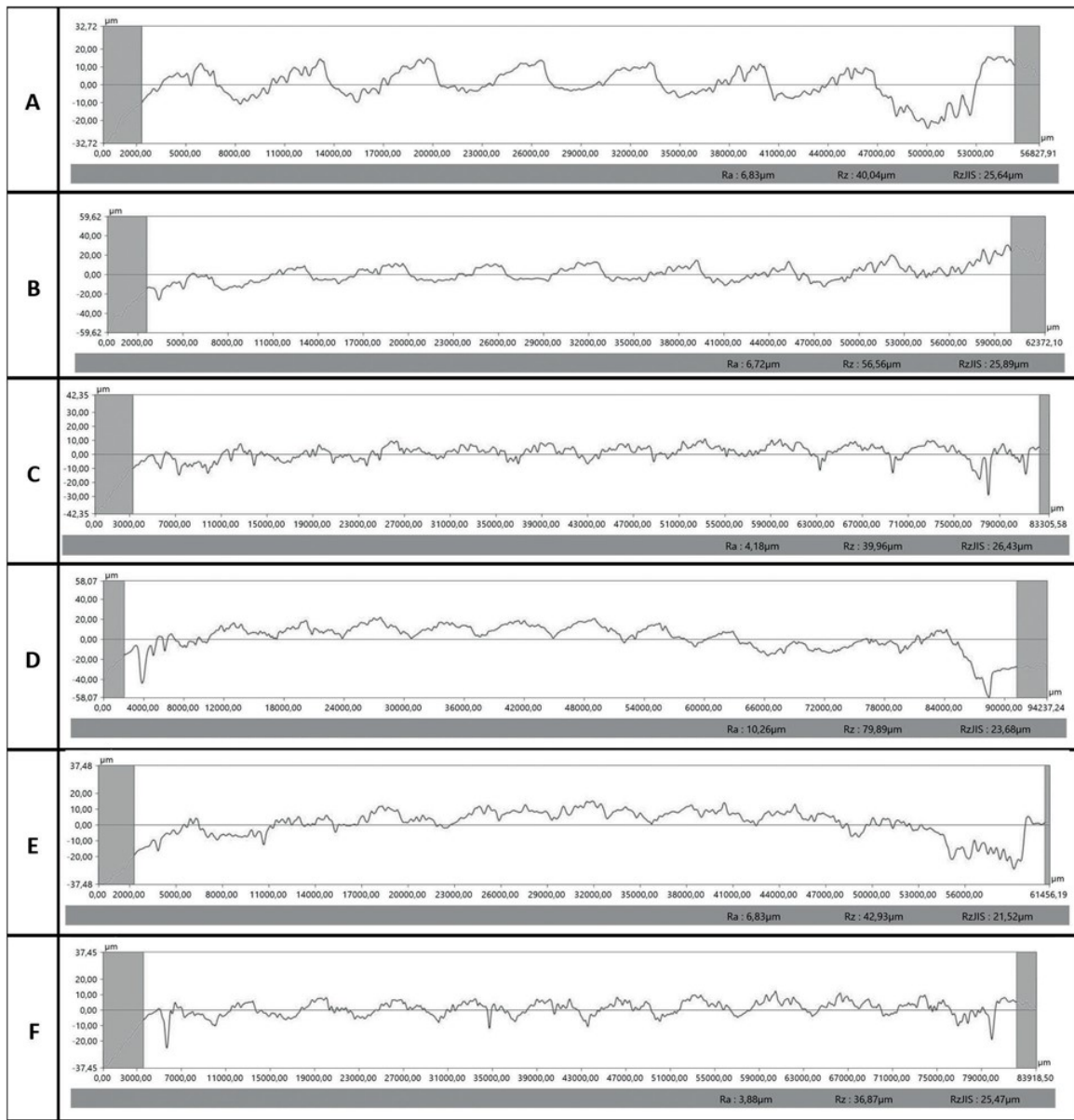

By analyzing the obtained diagrams and amount of contaminants supplied to the system, it was impossible to clearly determine how individual doses of the contaminants affected the wear process. The smallest doses of solid particles were added to the C and D measurements in the amount of 5 cm<sup>3</sup>, while the largest dose was for the F measurement in the amount of 25 cm<sup>3</sup>. For the NBR case, it appeared that the journal wear depended on the dose of contaminants, but in the case of PTFE, this did not appear to be the case, as shown by the roughness profiles of journal F in the presented diagrams and the condition of its surface. One thing is clear, namely, the water lubricating the plain bearings containing contaminants in the form of solid particles accelerated the wear process of the steel journal and increased the risk of

failure in the propulsion system of the propeller shaft line in the ship.

One may wonder about the differences in roughness Ra values among the individual samples. This difference is several times higher in the case of measurements using the optical microscope. Moreover, the roughness values of the journals cooperating with the rubber bushings often exceeded the Ra value for the journals mating with the PTFE bushing by ten times, which indicates the creation of a more diversified geometric structure after cooperation and the more intensive wear process of the journals. These differences may result from the time interval between the measurements of the journals with the profilometer and the microscope; also, with such small surfaces, it is impossible to measure the profile at

exactly the same point. An additional difficulty and a huge challenge are also the appropriate arrangement of the sample and setting and leveling the measuring instruments in such a way as to profile it perfectly on the cylindrical surface.

The observations were also made for the NBR and PTFE sliding sleeves. The surface condition after cooperation with a steel journal lubricated with water containing solid particles is shown in Figures 4 and 5 for the NBR and PTFE, respectively.

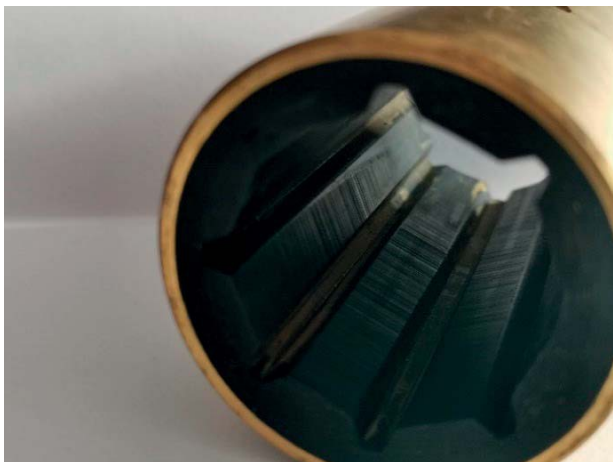

Fig. 4. The NBR sliding bush (C)



Fig. 5. The PTFE sliding bush (B)

Traces of wear caused by friction are visible on both internal surfaces of the bushings. The circumferential grooves were the result of sand particles getting between the shaft journal and the bush, but deeper grooves were seen in the NBR bush. As for the journals, the rubber bushings had the greatest wear in the middle of the bushing and at the edge of the load application. On the other hand, the wear of the PTFE bushings was evenly distributed over the entire surface of the joint. Inside, there were visible fragmented sand particles embedded in the longitudinal grooves, which could have

caused detachment the upper layer of the sleeve material, as shown in Figure 5.

Due to the observations of the bushings and the geometric structure of the journals, it was concluded that the NBR was more susceptible to deformation; damping vibrations also turned out to be worse than for the three-layer PTFE bushings. Factors that could have influenced such a course of the wear process of the sliding sleeves are the hardness of the material of the sleeves and the geometry of the sleeves. Particulate pollutants, like the sand from the Radunia River, can act as a cutting tool, especially for soft materials. Sand between the bush and the journal „sticks” into the material of the bushing, destroying the inner surface of the bush and the shaft journal at the same time and forming circumferential grooves on its surface. The active surface of both bushings was different due to the different number of grooves arranged longitudinally along the entire perimeter of the bushings. There were 8 NBR bushings and 6 PTFE bushings, which could indicate that the load field (i.e., the actual load) of both bearings operating under the same conditions was different.

## SUMMARY

Based on the conducted research and analysis of the results, it can be concluded that both the material and the geometry of the bushing as well as the type of contaminants (the amount and size of the solid particles) are key parameters that influenced the speed of the wear process of the sliding node lubricated with liquid containing solid particles. Even a small dose of contamination can intensify this process, but the higher the concentration of particles in the water was, the greater the bearing wear. Undoubtedly, the material of the bushing, which showed greater wear resistance during operation in the conditions of contaminated water, was PTFE. The rubber bushings experienced more intensive wear. Misalignment of the shaft in the plain bearing bush caused deformation and deflection of the shaft, which led to its edge bending and, consequently, accelerated the wear process of the friction elements.

The results of the tests carried out may have an impact on limiting critical environmental parameters and may also allow one to propose the most optimal design solutions and selection of optimal bushing materials based on the prevailing operating conditions so as to avoid intensive wear of friction elements while also ensuring durability, reliability and trouble-free operation of the sliding node of shaft lines on ships.

## ACKNOWLEDGEMENTS

This work was a part of research grant no. 2016/23/B/ST8/03104 entitled “Research on water lubricated sliding couples in conditions of improper lubrication conditions” financed by the Polish National Science Centre.

## REFERENCES

1. Author's Archive, 'Propeller shaft strut bearings'.
2. W. Dai, B. Kheireddin, H. Gao, and H. Liang, 'Roles of nanoparticles in oil lubrication', *Tribol. Int.*, vol. 102, pp. 88–98, 2016, doi: 10.1016/j.triboint.2016.05.020.
3. Z. J. Zhang, D. Simionesie, and C. Schaschke, 'Graphite and hybrid nanomaterials as lubricant additives', *Lubricants*, vol. 2, no. 2, pp. 44–65, 2014, doi: 10.3390/lubricants2020044.
4. A. Barszczewska, E. Piątkowska, and W. Litwin, 'Selected Problems of Experimental Testing Marine Stern Tube Bearings', *Polish Marit. Res.*, vol. 26, no. 2, pp. 142–154, 2019, doi: 10.2478/pomr-2019-0034.
5. A. Barszczewska, 'Experimental Research on Insufficient Water Lubrication of Marine Stern Tube Journal Bearing with Elastic Polymer Bush', *Polish Marit. Res.*, vol. 27, no. 4, pp. 91–102, 2020, doi: 10.2478/pomr-2020-0069.
6. N. Vulić, K. Bratić, B. Lalić, and L. Stazić, 'Implementing Simulation in the Modelling of Marine Shafting Steady State Torsional Vibrations', *Polish Marit. Res.*, vol. 28, no. 2, pp. 63–71, Jun. 2021, doi: 10.2478/pomr-2021-0022.
7. M. Moschopoulos, G. N. Rossopoulos, and C. I. Papadopoulos, 'Journal Bearing Performance Prediction Using Machine Learning and Octave-Band Signal Analysis of Sound and Vibration Measurements', *Polish Marit. Res.*, vol. 28, no. 3, pp. 137–149, 2021, doi: 10.2478/pomr-2021-0041.
8. A. Ursolov, Y. Batrak, and W. Tarelko, 'Application of the Optimization Methods to the Search of Marine Propulsion Shafting Global Equilibrium in Running Condition', *Polish Marit. Res.*, vol. 26, no. 3, pp. 172–180, 2019, doi: 10.2478/pomr-2019-0058.
9. H. Yang, J. Li, and X. Li, 'Calculation of the Dynamic Characteristics of Ship's Aft Stern Tube Bearing Considering Journal Deflection', *Polish Marit. Res.*, vol. 27, no. 1, pp. 107–115, 2020, doi: 10.2478/pomr-2020-0011.
10. J. Duchowski, 'Examination of journal bearing filtration requirements', *Lubr. Eng.*, vol. 09, pp. 1–9, 1998, [https://www.researchgate.net/publication/287750536\\_Examination\\_of\\_journal\\_bearing\\_filtration\\_requirements](https://www.researchgate.net/publication/287750536_Examination_of_journal_bearing_filtration_requirements).
11. J. Duchowski, 'Filtration requirements for journal bearings exposed to different contaminant levels', *Lubr. Eng.*, vol. 06, no. July, pp. 34–39, 2002, [https://www.researchgate.net/publication/287750720\\_Filtration\\_requirements\\_for\\_journal\\_bearings\\_exposed\\_to\\_different\\_contaminant\\_levels](https://www.researchgate.net/publication/287750720_Filtration_requirements_for_journal_bearings_exposed_to_different_contaminant_levels).
12. D. Hargreaves and S. C. Sharma, 'Effects of solid contaminants on journal bearing performance', *Proc. 2nd World Tribol. Congr.* 3-7 Sept. 2001, pp. 237–240, 2001, [https://figshare.com/articles/conference\\_contribution/Effects\\_of\\_solid\\_contaminants\\_on\\_journal\\_bearing\\_performance/13463030/1](https://figshare.com/articles/conference_contribution/Effects_of_solid_contaminants_on_journal_bearing_performance/13463030/1).
13. M. M. Khonsari and E. R. Booser, 'Effect of contamination on the performance of hydrodynamic bearings', *Proc. Inst. Mech. Eng. Part J J. Eng. Tribol.*, vol. 220, no. 5, pp. 419–428, 2006, doi: 10.1243/13506501J00705.
14. A. Dadouche and M. J. Conlon, 'Operational performance of textured journal bearings lubricated with a contaminated fluid', *Tribol. Int.*, vol. 93, pp. 377–389, 2016, doi: 10.1016/j.triboint.2015.09.022.
15. S. M. Park, G. H. Kim, and Y. Z. Lee, 'Investigation of the wear behaviour of polyacetal bushings by the inflow of contaminants', *Wear*, vol. 271, no. 9–10, pp. 2193–2197, 2011, <https://doi.org/10.1016/j.wear.2010.12.033>.
16. L. Peña-Parás et al., 'Effects of substrate surface roughness and nano/micro particle additive size on friction and wear in lubricated sliding', *Tribol. Int.*, vol. 119, no. August 2017, pp. 88–98, 2018, doi: 10.1016/j.triboint.2017.09.009.
17. A. Akchurin, R. Bosman, P. M. Lugt, and M. van Drogen, 'Analysis of Wear Particles Formed in Boundary-Lubricated Sliding Contacts', *Tribol. Lett.*, vol. 63, no. 2, pp. 1–14, 2016, <https://doi.org/10.1007/s11249-016-0701-z>.
18. A. Akchurin, R. Bosman, and P. M. Lugt, 'Generation of wear particles and running-in in mixed lubricated sliding contacts', *Tribol. Int.*, vol. 110, no. February, pp. 201–208, 2017, <https://doi.org/10.1016/j.triboint.2017.02.019>.
19. A. Akchurin, R. Bosman, and P. M. Lugt, 'A Stress-Criterion-Based Model for the Prediction of the Size of Wear Particles in Boundary Lubricated Contacts', *Tribol. Lett.*, vol. 64, no. 3, pp. 1–12, 2016, <https://doi.org/10.1007/s11249-016-0772-x>.
20. G. Pintaude, 'Characteristics of Abrasive Particles and Their Implications on Wear', *New Tribol. Ways*, no. April 2011, 2012, [https://www.researchgate.net/profile/Giuseppe-Pintaude/publication/221912389\\_Characteristics\\_of\\_Abrasive\\_Particles\\_and\\_Their\\_Implications\\_on\\_Wear/links/00b49525ef1357bd1d000000/Characteristics-of-Abrasive-Particles-and-Their-Implications-on-Wear.pdf](https://www.researchgate.net/profile/Giuseppe-Pintaude/publication/221912389_Characteristics_of_Abrasive_Particles_and_Their_Implications_on_Wear/links/00b49525ef1357bd1d000000/Characteristics-of-Abrasive-Particles-and-Their-Implications-on-Wear.pdf).
21. C. Q. Yuan, Z. Peng, X. C. Zhou, and X. P. Yan, 'The characterization of wear transitions in sliding wear process contaminated with silica and iron powder', *Tribol. Int.*, vol. 38, no. 2, pp. 129–143, 2005, doi: 10.1016/j.triboint.2004.06.007.

22. A. Ya and T. Yu, 'Revealing the influence of various factors on concentration and spatial distribution of suspended matter based on remote sensing data', *Proc. SPIE*, vol. 9638, pp. 1–12, 2015, <https://doi.org/10.1117/12.2193905>.
23. E. Szymczak and D. Burska, 'Distribution of Suspended Sediment in the Gulf of Gdansk off the Vistula River mouth (Baltic Sea, Poland)', *IOP Conf. Ser. Earth Environ. Sci.*, vol. 221, no. 1, p. 012053, Mar. 2019, doi: 10.1088/1755-1315/221/1/012053.
24. M. Damrat, A. Zaborska, and M. Zajaczkowski, 'Sedimentation from suspension and sediment accumulation rate in the River Vistula prodelta, Gulf of Gdańsk (Baltic Sea)', *Oceanology*, vol. 55, no. 4, pp. 937–950, 2013, doi:10.5697/oc.55-4.937.
25. Geological Institute and Geology Institute, 'Lithology and mineral composition of sediments from the bottom of the Gdańsk Basin', vol. 313, no. 2, 1980, [https://gq.pgi.gov.pl/article/viewFile/8797/pdf\\_830](https://gq.pgi.gov.pl/article/viewFile/8797/pdf_830) (in Polish).
26. T. Leipe and B. Sea, 'The kaolinite/chlorite clay mineral ratio in surface sediments of the southern Baltic Sea as an indicator for long distance transport of fine-grained material', *Baltica*, vol. 16, pp. 31–36, 2003, [https://gamtostyrimai.lt/uploads/publications/docs/211\\_37972ec38c101346e9b8223cb576dc8b.pdf](https://gamtostyrimai.lt/uploads/publications/docs/211_37972ec38c101346e9b8223cb576dc8b.pdf).
27. Y. Solomonov, Experimental investigation of tribological characteristics of water-lubricated bearings materials on a pin-on-disc test rig, The University of Adelaide, School of Mechanical Engineering, Master of Philosophy Thesis, April 2014, <https://digital.library.adelaide.edu.au/dspace/bitstream/2440/84676/8/02whole.pdf>, <https://hdl.handle.net/2440/84676>.
28. C. L. Dong, C. Q. Yuan, X. Q. Bai, Y. Yang, and X. P. Yan, 'Study on wear behaviours for NBR/stainless steel under sand water-lubricated conditions', *Wear*, vol. 332–333, pp. 1012–1020, 2015, 10.1016/j.wear.2015.01.009.
29. C. Yuan, Z. Guo, W. Tao, C. Dong, and X. Bai, 'Effects of different grain sized sands on wear behaviours of NBR/casting copper alloys', *Wear*, vol. 384–385, pp. 185–191, Aug. 2017, doi: 10.1016/j.wear.2017.02.019.
30. T. Chang, Z. Guo, and C. Yuan, 'Study on influence of Koch snowflake surface texture on tribological performance for marine water-lubricated bearings', *Tribol. Int.*, vol. 129, pp. 29–37, 2019, doi: 10.1016/j.triboint.2018.08.015.
31. Z. Wu, C. Sheng, Z. Guo, F. Li, 'Equivalent Calculate of the Equivalent Radius and the Tribological Performance of the Marine Water-Lubricated Bearing', *Mocaxue Xuebao/Tribology*, vol. 37, no. 5, pp. 656–662, 2017, doi: 10.16078/j.tribology.2017.05.013.
32. Z. Jia, Z. Guo, C. Yuan, 'Effect of Material Hardness on Water Lubrication Performance of Thermoplastic Polyurethane under Sediment Environment', *J. Mater. Eng. Perform.*, vol. 30, no. 10, pp. 7532–7541, 2021, doi: 10.1007/s11665-021-05912-z.
33. X. Liang, Z. Guo, J. Tian, C. Yuan, 'Development of modified polyacrylonitrile fibers for improving tribological performance characteristics of thermoplastic polyurethane material in water-lubricated sliding bearings', *Polym. Adv. Technol.*, vol. 31, no. 12, pp. 3258–3271, 2020, doi: 10.1002/pat.5050.
34. Z. Cui, Z. Guo, X. Xie, C. Yuan, 'The Synergistic Effect Mechanism of PA66 Self-Lubrication Property and Surface Texture on Tribological Performance of HDPE Water-Lubricated Bearing', *Mocaxue Xuebao/Tribology*, vol. 39, no. 4, pp. 407–417, 2019, doi: 10.16078/j.tribology.2018171.

#### CONTACT WITH THE AUTHOR

**Ewa Piątkowska**

*e-mail: ewapiatk@pg.edu.pl*

Gdansk University of Technology,  
ul. Gabriela Narutowicza 11/12  
80-233 Gdańsk,  
**POLAND**