



## OPEN ACCESS

## EDITED BY

Flah Aymen,  
École Nationale d'Ingénieurs de Gabès, Tunisia

## REVIEWED BY

José Baptista,  
University of Trás-os-Montes and Alto Douro,  
Portugal  
Ramesh G. P.,  
St Peter's Institute of Higher Education and  
Research, India  
Mohammed Rashad Baker,  
University of Kirkuk, Iraq

## \*CORRESPONDENCE

Przemysław Falkowski-Gilski,  
✉ [przemyslaw.falkowski@eti.pg.edu.pl](mailto:przemyslaw.falkowski@eti.pg.edu.pl)  
Parameshachari Bidare Divakarachari,  
✉ [paramesh@nmit.ac.in](mailto:paramesh@nmit.ac.in)

RECEIVED 18 December 2023

ACCEPTED 13 March 2024

PUBLISHED 10 April 2024

## CITATION

Srihari G, Krishnam Naidu RSR,  
Falkowski-Gilski P, Bidare Divakarachari P and  
Kiran Varma Penmatsa R (2024), Integration of  
electric vehicle into smart grid: a meta heuristic  
algorithm for energy management between  
V2G and G2V.  
*Front. Energy Res.* 12:1357863.  
doi: 10.3389/fenrg.2024.1357863

## COPYRIGHT

© 2024 Srihari, Krishnam Naidu, Falkowski-Gilski, Bidare Divakarachari and Kiran Varma Penmatsa. This is an open-access article distributed under the terms of the [Creative Commons Attribution License \(CC BY\)](https://creativecommons.org/licenses/by/4.0/). The use, distribution or reproduction in other forums is permitted, provided the original author(s) and the copyright owner(s) are credited and that the original publication in this journal is cited, in accordance with accepted academic practice. No use, distribution or reproduction is permitted which does not comply with these terms.

# Integration of electric vehicle into smart grid: a meta heuristic algorithm for energy management between V2G and G2V

G. Srihari<sup>1</sup>, R. S. R. Krishnam Naidu<sup>2</sup>,  
Przemysław Falkowski-Gilski<sup>3\*</sup>,  
Parameshachari Bidare Divakarachari<sup>4\*</sup> and  
Ravi Kiran Varma Penmatsa<sup>5</sup>

<sup>1</sup>School of Technology, The Apollo University, Chittoor, India, <sup>2</sup>Department of Electrical and Electronics Engineering, Nadimpalli Satyanarayana Raju Institute of Technology, Visakhapatnam, India, <sup>3</sup>Faculty of Electronics, Telecommunications and Informatics, Gdansk University of Technology, Gdansk, Poland, <sup>4</sup>Department of Electronics and Communication Engineering, Nitte Meenakshi Institute of Technology, Bengaluru, India, <sup>5</sup>Department of CSE, Sagi Rama Krishnam Raju Engineering College, Bhimavaram, India

Recently, Electric Vehicles (EV) have been providing fast response and substantial progress in the power generation model. Further, EVs are exploited as adaptable Energy Storage Systems (ESSs) and show a promising performance in ancillary service markets to increase the demand of Smart Grid (SG) integration. The expansion of Vehicle-to-Grid concept has created an extra power source when renewable energy sources are not available. Yet, numerous operational problems still are required to be considered for EV implementation to turn out to be extensive. Even the development of Photo-Voltaic (PV) technology creates a problem in SGs when used for EV charging. Because of this, the Energy Management System (EMS) is required to handle charging requirements and deal with the intermittent generation. Here, in this research, an Improved Honey Badger algorithm (IHBA) is proposed for integrating SGs with EV parking lot, solar panels, and dynamic loads at the Point of Common Coupling (PCC). The proposed IHBA uses a dynamic programming method to optimize the charging Grid-to-Vehicle (G2V) or discharging Vehicle-to-Grid (V2G) profiles of the EVs using the forecasts of PV generation. This algorithm considers user preferences while also lowering reliance on the grid and maximizing SG effectiveness. The study's findings show that the Honey Badger method is efficient in resolving issues involving large search spaces. The developed method is used to optimize charging and discharging of EV which is tested in MATLAB to obtain a stable load profile. From the evaluation of obtained results, it is evident that the IHBA controller outperforms the WOA and EHO controllers in terms of total harmonic distortion voltage (3.12%), power loss (0.197 kW) and efficiency (98.47%).

## KEYWORDS

electric vehicle, energy management system, energy storage systems, improved honey badger algorithm, smart grid, photo-voltaic

## 1 Introduction

In recent days, one of the electric industry's areas of expanding interest is the smart grid (SG). An integrated communication and power system known as SG enables a robust, bi-directional communication infrastructure with distributed computers. Additionally, enhanced control, stability, and optimized power delivery are made possible by this system (Makeen et al., 2023). In cities where Plug-in Electric Vehicles (PEVs) are widely available, parking lots should consider implementing smart management and scheduling options. The rapid advancement of Electric Vehicle (EVs) has resulted in a considerable burden on the power grid system for the implementation of an effective control framework (ur and Rehman, 2022). The process of charging EVs imposes an excessive strain on the power grid, leading to voltage fluctuations and supply shortages. As PEVs continue to increase, they are emerging as the most probable alternative to combustion engine vehicles (Spanoudakis et al., 2023). In comparison to other new energy vehicles like Hybrid EVs (PHEVs), PEVs possess larger storage batteries, making them well-suited for participating in Grid-to-Vehicle (G2V) or Vehicle-to-Grid (V2G) energy supervision (Grasel et al., 2023). Grid operators and vehicle owners are showing interest in V2G because it presents a potential backup for renewable energy sources like solar and wind power. Additionally, they enhance the grid's technical performance in respect to efficiency, stability, dependability, and generation dispatch. Since many EVs are useable as both a load and an ESS to assist the grid, a new emerging technology called V2G has emerged. Nonetheless, the disorganized EV charging demonstrates a significant influence on the power system. Therefore, optimal V2G system coordination is required (Zhang et al., 2023a). There are many different types of business models and information system architectures related to smart grids that are suggested until today, but none of them are consistent with specific standards (Ismail et al., 2023). Effective management of electric vehicles has the potential to enhance the reliability and stability of power grids. Furthermore, they facilitate the integration of renewable sources and improve the overall efficiency of the system (Kumari et al., 2022). Energy Management Systems (EMS) enables the operation and supervision of Battery Energy Storage Systems (BESS) in standalone power systems (Thiruganani et al., 2023).

Generally, the vehicle utilizes both the internal combustion engine as well as battery-powered motor powertrain. The petrol engine is exploited to operate and charge the vehicle once the battery gets drained. Some model-free methodologies have lately demonstrated their efficacy in a variety of decision-making applications, including e-healthcare and Intelligent Transportation Systems (ITS) (Zhang et al., 2023b). Reinforcement learning does not require prior system knowledge, it learns a sound control strategy and acts appropriately to attain desired goals. Rarely documented are EV batteries as storage with a bidirectional converter (Kumar et al., 2022). It is advised to employ high power quick charging when using EVs as energy storage systems. The early stages of V2G progress within a smart grid facility aimed at facilitating power generation from unpredictable renewable energy sources. Additionally, a majority of reported studies employ Level 1 and 2 charging for V2G technology

(Sureshkumar et al., 2022). V2G technology, also referred to as Vehicle-Grid Integration (VGI), enables the transfer of surplus power from electric vehicles to the smart grid. This innovative approach aids in meeting electricity demands during the high usage periods, and serves as an additional energy source when weather-dependent renewable sources are inaccessible (Egbue et al., 2022). The system power quality is impacted by EV charging which affects different sections of the distribution grid. Unplanned and undesirable peaks in the grid demand are caused by the uncoordinated charging of electric vehicles. Furthermore, fast charging and the presence of non-linear components in the charging infrastructure cause harmonic content to be introduced into the grid voltage (İnci et al., 2022). In addition, this causes power outages, voltage instability, transformer overloading, and a decline in reliability indices. Moreover, when EVs are charged using pre-existing connections, voltage instability occurs in the host facilities. The battery storage capacity of a single PHEV is minimal when compared to the grids (Liu et al., 2023). Because EVs require a lot of power to recharge their batteries, using them has an undesirable influence on the power quality. Transformer life cycle decreases when EV interference in the system increases. Even so, by grouping PHEVs as storage devices, an improved coordination and dependability is attained in a smart grid (Tirunagari et al., 2022). Therefore, a distribution and transmission system operator, the electrical market and PHEV owners, all work together effectively with the help of an aggregator which is useable as a communication/controller device or algorithm.

The main contributions of this research are as follows.

- This article use an EMS named Improved Honey Badger Algorithm (IHBA) which is deployed to suggest how energy is distributed among ESS, PV, and EV.
- The IHBA method of controlling the converter current and DC bus voltage is provided. Implementing a control method allows for the stabilization of the DC bus voltage.
- A review of different topologies is used to connect the batteries and the load. This analysis, which outlines the merits and downsides of each structure, is displayed using a variety of models.

The manuscript is structured as follows: the existing researches based on EMS in EV are described in Section 2. The suggested IHBA is described in Section 3, while the explanation of outcomes are presented in Section 4. At last, the conclusions are detailed in Section 5.

## 2 Literature review

A wide-ranging Switched Reluctance Motor (SRM) for plug-in EVs was developed by Cheng et al. (Cheng et al., 2020) based on a variety of driving and charging measurements. The motor driving mode had four essential activities that were to be performed in order to accurately analyze the decelerating actions. There were three ways to charge batteries that did not require extra battery points. For the objective of recharging the drive battery, a three-channel periodic boost converter featuring PF control characteristics was executed by SRM windings and associated converters. An incorporated half-

bridge converter was used to power the additional batteries from the engine. However, it had a huge loss.

Liu et al. (Liu et al., 2020) demonstrated a new method called Hierarchical V2G/G2V EMS for rechargeable drive reassembled through onboard circuit along with a converter. A V2G energy management system containing an Electric Drive Range-Extended On-Board Charger (EDROC) was suggested. In the V2G/G2V, the suggested EDROC employed a synchronous motor as a charging inductance, eliminating the need for extra equipment. Additionally, this research presented a classified V2G/G2V EMS along with a control approach that contained EDROC which reduced the dispersion of PEV State of Charge (SOC).

He et al. (He et al., 2021) presented a new technique named Four-Quadrant Operation of Bidirectional charges for EV in parking lots. This research presented to achieve the objective of maintaining a constant current during the charging and discharging processes of EV on the load side. By employing the Model Predictive Control (MPC) strategy, EV chargers efficiently transferred both active and reactive powers among EV batteries, as well as the grid. In the exchange of active power, a new mode called V2G was presented. But the system required approximately three grid cycles, equivalent to 60 milliseconds, in order to respond to a fresh command.

Justin et al. (Justin et al., 2022) presented a new method named V2G by means of fast charging stations. EV batteries having the potential to serve as energy storage units in smart grids, contributed to the energy in small power networks. They stored excess energy from the grid to provide energy back to the grid when there was a need for it. A test system for a smart grid was designed, and included a DC fast charging station to connect with the EV. An appreciable total harmonic distortion was attained by sensible design of the LCL filter. Nonetheless, according to IEEE standards, the harmonic current distortion was low and limited in this research.

Dhasharatha et al. (Rahman et al., 2018) represented a new technique of simulation and analysis of V2G and G2V technology in electric vehicles. This paper presented a design for executing V2G-G2V system within a smart grid, specifically utilizing Level 3 fast charging for EVs. The architecture included a modeled smart grid test system that incorporated a fast-charging place for connecting with EVs. Simulation studies were conducted to display the energy transfer capabilities of V2G-G2V within the system. Harmonic distortion was limited and underneath on power systems standards.

An innovative method known as Smart EMS for electrical grids driven by heterogeneous renewable energy sources and EV storage was presented by Madhavaram and Manimozhi (Madhavaram and Manimozhi, 2022). The method offered an innovative EMS for SGs that made use of EV storage and unconventional energy sources. While several studies explored MG EMSs with energy storage, their implementation in real-time scenarios was often hindered by various factors. Nevertheless, there was room for the development of more advanced and intelligent decision-making strategies, specifically tailored for Electric Vehicle Systems (EVs).

Al-Abri and Albadi (Al-Abri and Albadi, 2022) implemented an effect of vehicles on the planning and operation of the distribution method. This research described the capability of services offered by EVs and found the potential effect. At the distribution system level, EVs offered ancillary works based on local operational problems, and furthermore, the categorization was variant from market to market as well as from need of individual country's laws. While

utilizing this method to reduce the negative effects, choosing the optimal sizing and spot of EVs charging values was essential to manage the power quality and trust ability. Yet, it further required to consider the potential effect of EVs on reactive power market architecture and the economy.

Hybrid storage was demonstrated by Guentri et al. (Guentri et al., 2021) as a means of controlling and managing PV array energy. The goal of this study was to modify the energy sources' voltage regulation architecture in accordance with these reliable control ideas. The performance metrics and dependability of these methods were also evaluated. Efficiency was increased by using the Genetic Algorithm (GA) optimization technique, which significantly reduced peak overshoot and settling time. The GA-based Proportional Integral Derivative (PID) controller architecture only caused problems for the machine after 67% of it was reached.

An EMS for grid-EV and renewable power was successfully developed by Al-Dhaifallah et al. (Al-Dhaifallah et al., 2021). Three different charging techniques were taken into consideration in order to evaluate the behavior of EVs: supervised, unsupervised, and smart charging methods. Through the utilization of the Modified Harmony Search (MHS) method, micro grid optimization planning was handled. Although it was a crucial issue, the MG's Day-ahead planning merits more thought. However, a number of problems, such as their short battery life, poor start-up performance, and limited driving range were preventing them from developing further.

By controlling the PFC and DC voltage with a Resettable Integrator (RI) control technique, Kanimozhi et al. (Kanimozhi et al., 2022) presented an effective two-stage charger system. The regulator handled a nonlinear switching converter with a quicker dynamic response and enhanced its robustness. The rectifier diodes and inverter switches were used in the following phase to help them achieve ZVS/ZCS. However, the switching loss increased in proportion to the power that was shielded from the diode's presence when the diode delay was considered.

Using an Artificial Neural Network (ANN) in conjunction with the Particle Swarm Optimization (PSO) method for battery Electric Vehicle (EV), Nouri et al. (Nouri et al., 2024) presented a V2G system with intelligent management to guarantee precise and steady energy extraction from the solar power system, even under varying sunlight situations. While combined with the Constant Voltage/Constant Current method, the fuzzy logic system ensures that the electric vehicle batteries are charged and discharged in compliance with exact pre-established circumstances. But when EVs do not take part in energy management, the energy efficiency value drops, emphasizing how important V2G operation is. In these situations, the grid makes up for the energy shortage, which was ineffective from a commercial perspective.

## 2.1 Review

This study examined a number of V2G technology-related topics, including advantages and disadvantages. Research indicates that the automotive and electric power sectors are mutually beneficial, and bolstering one through the other is advantageous for both. Regarding renewable energy, low emissions, energy economy, and power system dependability,

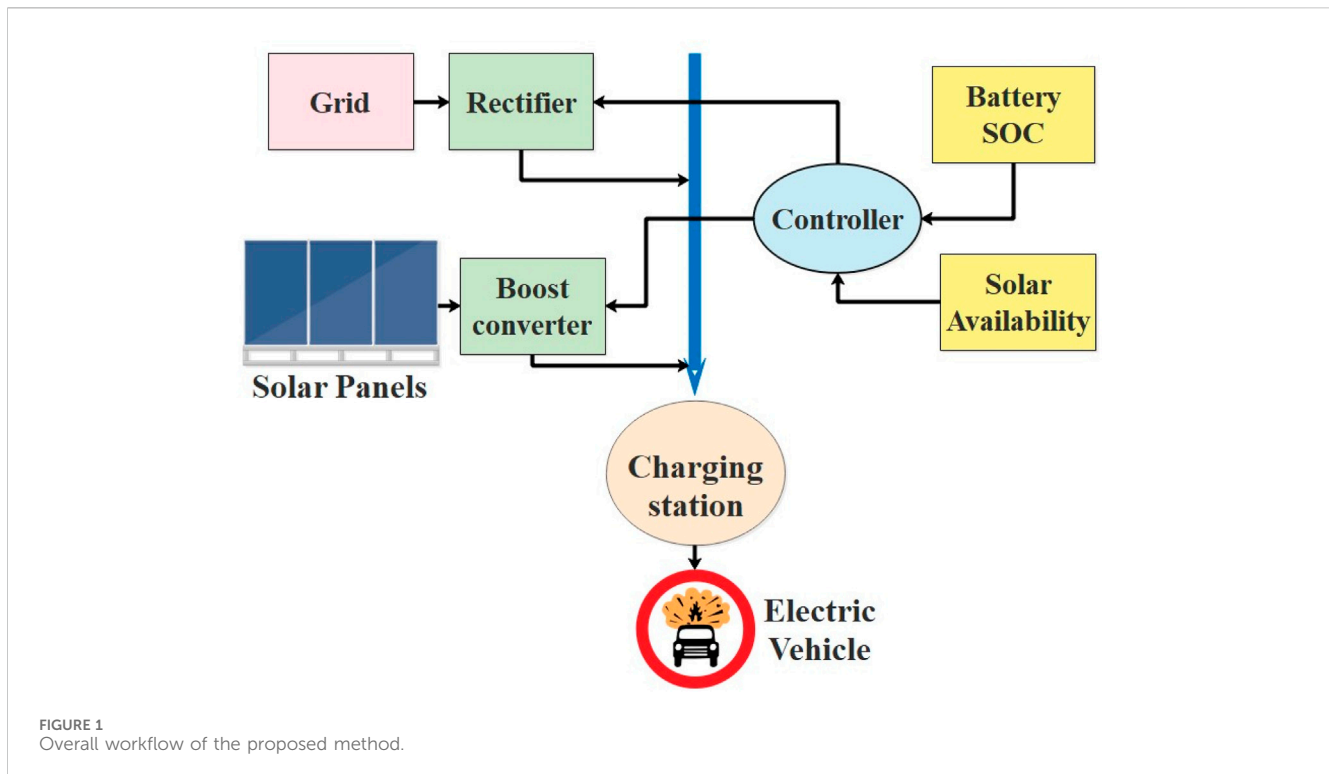

V2G technology is very promising. This technology offers ancillary services in addition to making it simple to integrate renewable resources into the utility. The power sector is made more dependable and stable by having a sufficient number of EVs with V2G capability on the road and an effective power management and control strategy. But there are many obstacles to EV grid integration, particularly in developing nations. Range anxiety, a lack of consumer awareness, high ownership costs, and inadequate charging infrastructure are the main issues impeding the widespread adoption of electric vehicles. Understanding the change in interest in the automotive and power markets is crucial in this regard. This essay addresses the numerous ideas surrounding EVs, the potential provided by V2G, the challenges associated with implementation, and possible solutions.

### 3 Proposed methodology

A hybrid system consisting of Photo-Voltaic (PV) cells and batteries is recommended as a resolution for various problems. A continuous charging of EVs is presently not viable, conferring to the grid overload. Users are unsure because of the charging disruptions. Hence, combining grid-connected charging with battery and PV charging is suggested to tackle the issue of car charging. The proposed method works well for providing EV charging without any delays. The main benefit of the proposed system is its capacity to promptly meet the charging requirements of all EVs, while also minimizing the increased grid burden. Many optimization methods are used to develop this control algorithm. Figure 1 shows a summary of the proposed method.

The generation and consumption of power varies over time and space with distributed energy sources. The traditional power grid's

energy management is now more difficult and complex as a result. With the expansion of SG, power distribution has become more adaptable, effective, dependable, and secure. Smart energy metering, improved control, and advanced communication technologies are all included in the smart grid.

In smart grids, EV batteries are exploited as potential storage devices which assist in EMS by saving energy once it is surplus (G2V), and then returning it to grid (V2G) as soon as needed. The development of appropriate control systems and infrastructure is necessary to make this idea a reality. This article provides the design for integrating EV fast charging into a smart grid for a V2G-G2V system. An EV interface is provided by a dc fast charging station in a simulated smart-grid test system. V2G-G2V power transfer is established over modelling studies where the regulator delivers better dynamic results based on voltage stability, while the charging station strategy guarantees limited THD of the grid injected current.

#### 3.1 Energy management system

The goal of power distribution networks is to run smoothly in order to provide more efficient and reliable electricity to local consumers. But when more EVs are adopted, the demand profile for each distribution network is significantly increased, which further puts pressure on the network's stability and structural integrity. When modelling grid stability, the different contributing factors that affect the EV charging load are crucial. The random travel habits of multiple EV users lead to intermittent charging patterns, which cause load fluctuations and imbalances in the grid's component parts. A specialized block uninterruptedly gathers power data from various sources, such as EV charging

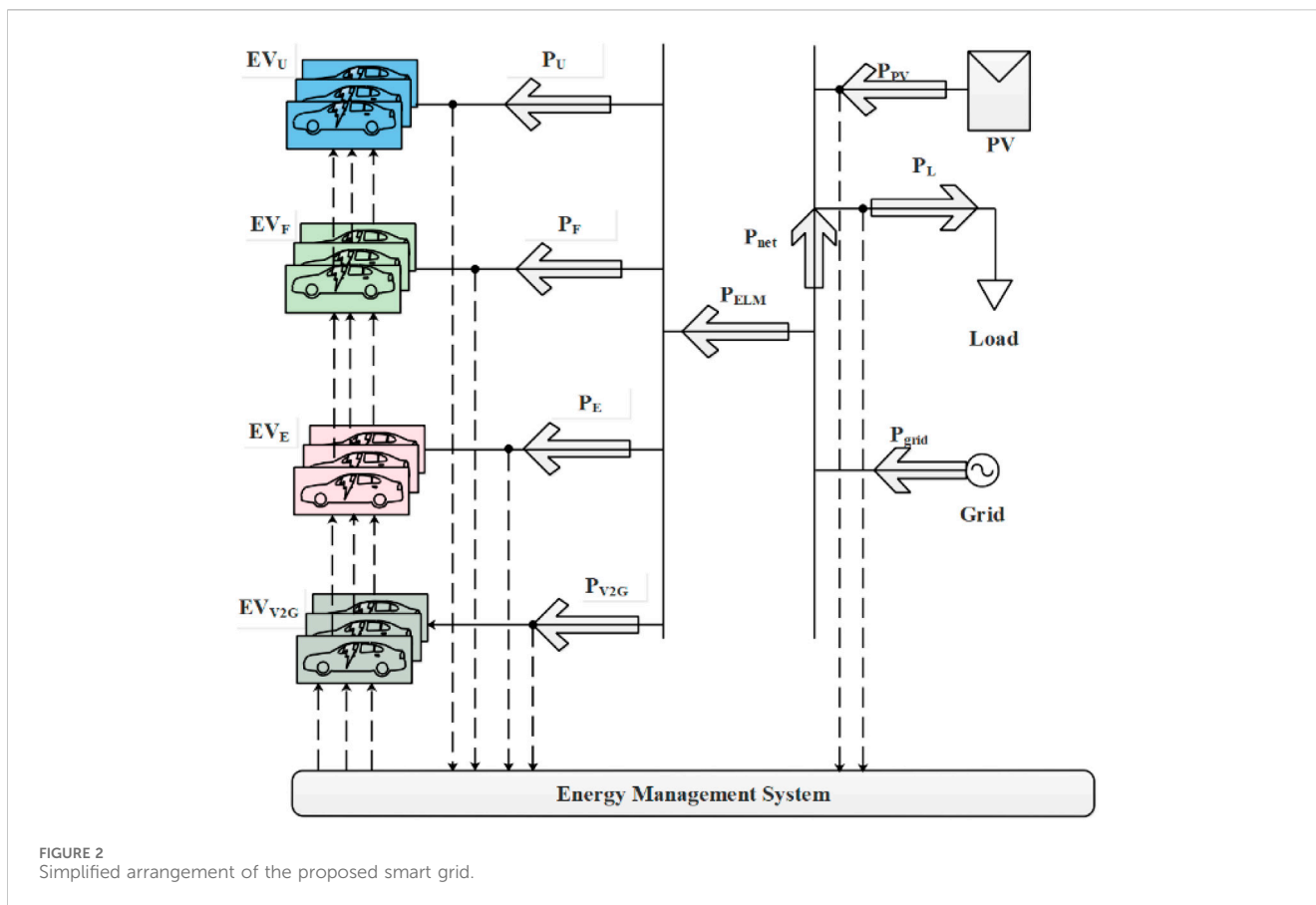

stations, PV systems, and smart grids (Bot et al., 2022), for use in the EMS that is provided. The EMS makes excellent use of this information to organize EV charging (Karoń, 2022). Additionally, the EMS also gathers unique EV charging profiles supplied by the EV user when they arrive at the parking lot in order to optimize the operation of SG. The EV data profile is structured as  $EV_{i,j}$  {struct}, where  $i$  refers to the charger group and  $j$  refers to the charger's outlet. The data structure contains several key parameters, including user/vehicle identifier ( $ID$ ), the chosen charging mode ( $Mode$ ), connection time ( $t_0$ ), expected disconnection time ( $t_f$ ), current state of charge ( $SOC_c$ ), desired final stage of charge ( $SOC_f$ ), maximum battery capacity ( $E_{bat}$ ), and nominal charging power ( $P_{nom}$ ). These parameters are crucial for effective management and optimization of EV charging within the smart grid.

EVs are arranged in a suggested simplified configuration of the SG illustration ( $P_{EV_v}$ ), as shown in Figure 2.  $P_{PV}$  and  $P_L$  stand for power produced by PV panels and power used through loads. Additionally, the energy management happens from the power system which employs optimization to find the precise charging instruction ( $P_{EV_v}$ ) for all the charging apparatuses. The suggested EMS presents a collection  $\mathcal{M} = \{EV_u, EV_F, EV_E, EV_{V2G}\}$  consisting of four distinct modes for EV charging: ULTRA, FAST, ECO, and V2G.

The complete power flow connected with each vehicle working in every charging mode is characterized by  $P_u$ ,  $P_F$ ,  $P_E$ , and  $P_{V2G}$ , consistently. In this research, reactive power values are not taken into consideration as they have focused only on active power which have been taken into an account for optimization process. Similarly,

distribution impedance is not to be taken into account; instead, all converters' efficiency is evaluated. In order to use the same station for multiple charging modes, EV users choose charging mode at any place. Grid loads are typically divided into two categories, dynamic and static. The generation of PV is exploited to characterize the various climate environments, and it is assumed that this paper represents a characteristic demand outline of a profitable formation. From Figure 3, it is seen that the power flow constraints of the suggested scheme configuration is characterized by  $P_{grid} = P_{net} + P_{EV_M}$ , where  $P_{net} = P_L - P_{Pv}$ . The balance between electricity demand and generation is represented by the above equation. The reasonable layout of EMS block that comprises of the four efficient components: acquisition, supervision, optimization, and prediction is shown in Figure 3.

### 3.2 EMS operation

Driver behavior which is dependent on a number of factors including weather, traffic density, acceleration rate, and keeping a minimum safe space between following vehicles, is a major influence in determining how much energy an electric vehicle uses. Multiple EVs charging at once, have a negative impact on the power system because fast charging stations are under a lot of strain. One of the main concerns for power systems is the possibility of a quick adoption of EVs, and a move toward electric transportation networks. Optimizing charging techniques to reduce peak demand is a crucial step in preventing the electrical system from

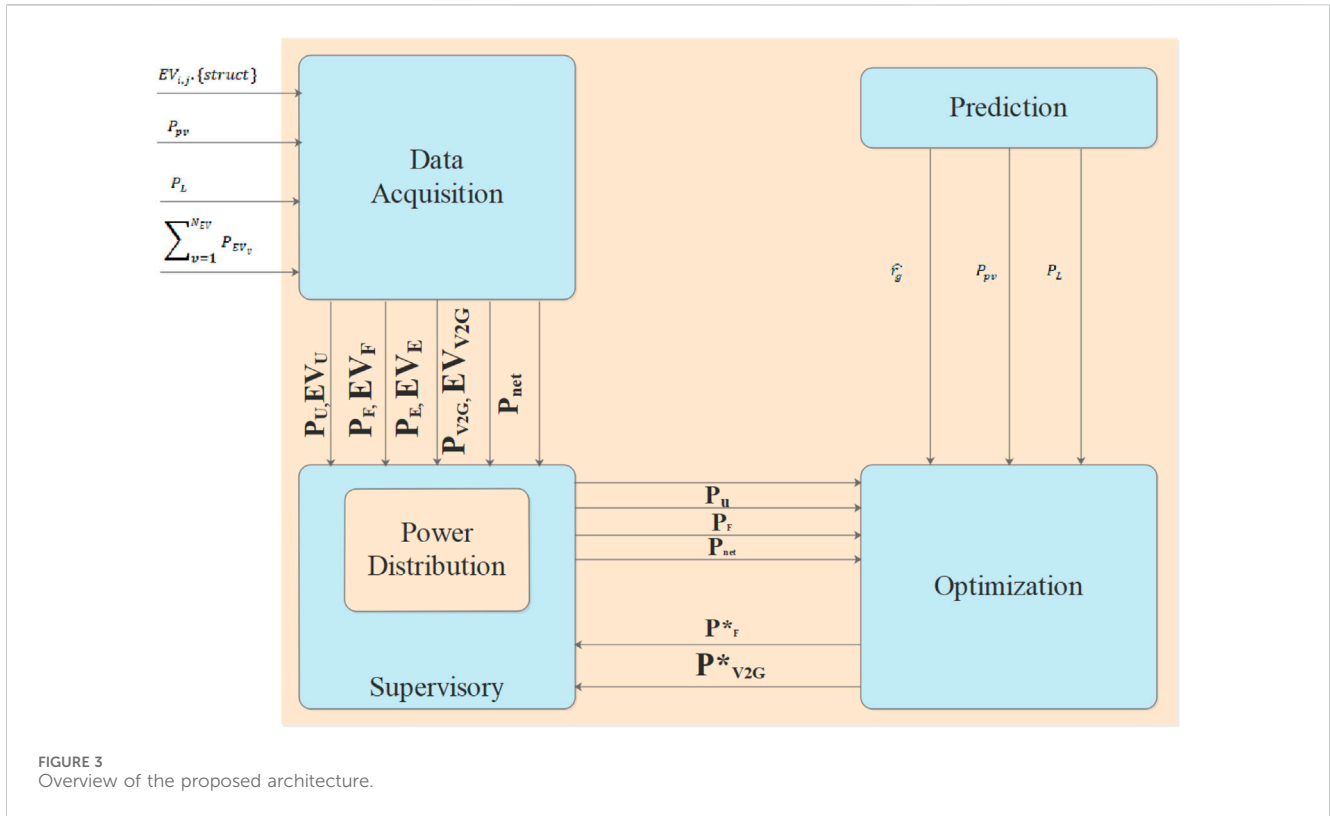

FIGURE 3 Overview of the proposed architecture.

being overloaded. The EV user chooses the anticipated charging outline when a car is plugged into a charging station, while the acquisition model collects and organizes data from the EV user. In addition, there is an ongoing load demand and PV generation acquisition. Real-time tasks inside the system are managed by the supervisor module (Raju et al., 2023). Data from the acquisition module is used to determine whether an optimization procedure is required. The supervisor component separates and guides the outcomes to inverter after updating the power references for the ULTRA and FAST charging modes at the end of every calculation step. An optimization procedure is also started by the supervisor module when the ECO and V2G modes are chosen. A dynamic programming is utilized in this scenario to determine power references for EV charging during the course of the connection period. Dynamic programming is used in the optimization process to obtain the ideal charging progression throughout the day. By giving predicted data, the prediction module helps with optimization of energy price ( $\hat{r}_g$ ), PV generation forecast ( $\hat{P}_{pv}$ ), and load demand ( $\hat{P}_L$ ).

### 3.3 EV functional mode

To establish each vehicle's state of charge (SOC) behavior, and to update the investigation, a battery is used (Mojumder et al., 2022; Gan et al., 2024). Eqs 1, 2 mathematically represent the SOC.

$$SOC_v[n + 1] = SOC_v[n] + \eta EV \frac{P_{EV_v}[n]\Delta t}{E_{bat_v}} \quad (1)$$

The equation for SOC behavior of each vehicle based on a linear battery model is as follows.

- $SOC_v[n + 1]$  characterizes the resultant battery proportion of one sample gain (at sample  $n+1$ ) for vehicle  $v$ .
- $SOC_v[n]$  represents the current battery percentage for vehicle  $v$  at sample  $n$ .
- $\eta EV$  denotes the charging/discharging efficiency.
- $P_{EV_v}[n]$  represents the charging power available for vehicle  $v$  at the current sample  $n$ .
- $E_{bat_v}$  denotes the total battery capacity for vehicle  $v$ .

$$0 \leq SOC_v[n + 1] \leq 1, \quad (2)$$

Which restricts the control performance and provides the charging electric vehicle  $PEV_v$  as given in Eq. 3:

$$PEV_v = \begin{cases} P_{EV_v}, & \text{if } 0 \leq SOC_v[n + 1] \leq 1, \\ 0, & \text{otherwise} \end{cases} \quad (3)$$

The EV integration position is demarcated as shown in Eq. 4:

$$EV_{conn} = \begin{cases} 1, & \text{if } EV_{i,j}\{t_0\} \leq EV_v(t_m) \leq EV_{i,j}\{t_f\}, \\ 1, & \text{if } SOC_v[n + 1] \leq 1, \\ 0, & \text{otherwise} \end{cases} \quad (4)$$

In Eqs 2, 3,  $\{EV_{i,j}\{t_f\}\}$  and  $\{EV_{i,j}\{t_0\}\}$  are parameters of EV acquisition framework and refer to the initial and final charging times, correspondingly. The parameter  $t_m$  signifies the current time within the time period  $[t_i, t_f]$ . Originally, the rate of  $t_i$  is quantified as  $t_0$ .

### 3.4 Supervisory and optimization algorithm based on honey badger algorithm

Optimization issues like optimal power flow and electrical vehicle charged orderly planning are addressed by IHBA. Therefore, the benefits of applying IHBA to optimization problems include superiority based on convergence speed and a balance among exploration and exploitation. The clear explanation about IHBA is explained in the following section.

#### 3.4.1 General biology

Honey Badgers (HB) have fluffy black and white fur and are known for their fearlessness. They are about the size of a dog, with a body length of 60–70 cm, and a weight range of 7–13 kg, but hunt and prey fearlessly on about 60 different species including poisonous snakes. These critters are intelligent and enjoy feeding on honey, as well as using tools. They normally live alone in self-dug burrows and cooperate with remaining badgers during the mating season. The HBs have 12 recognized subspecies. They do not have a particular breeding season, and cubs are born all year long. Whenever larger predators are unable to flee, honey badgers are brave, and do not hesitate to attack them. These animals also reach out to bird nests and beehives for food, thanks to their exceptional climbing abilities (Hashim et al., 2022).

In order to find its prey, the honey badger uses its anticipation of smell and sluggish, continuous pacing. It uses a persistent search and digging method to locate its target's general position before capturing it. In search of food, the honey badger excavates up to fifty holes in a day throughout a 40-km or even greater radius. Although honey is a HB's favorite delicacy, they are not very good at discovering beehives. On the other hand, the honeyguide bird detects beehives skillfully, but lacks the tools to get to the honey inside. So, this bird acts as a guide and directs the badger to the swarm, aids and exposes the beehives with its long claws, setting the stage for a mutually advantageous link or connection among the two creatures. As a consequence, both creatures benefit from their collaboration and share in the spoils (Chen et al., 2022).

#### 3.4.2 Inspiration

The HBA reproduces the foraging performance of this creature, consisting of two approaches for finding food; smelling and burrowing, or using a honey guidance mode. The first approach is recognized as the digging, and its subsequent process is acknowledged as honey. Honey badger utilizes its sense of smell to find its prey while it is in the digging mode. Once it has reached the general region, it investigates the surroundings, encircling the prey to discover the best site for digging and apprehending it. It follows the honey route which is guided by the bird that facilitates direct communication among the honeyguide bird and the beehives.

#### 3.4.3 Steps for algorithm

HBA is a global approach which subsequently takes into account both the exploration and exploitation phases (Düzenli et al., 2022). To begin with, the initial population with a uniform distribution is created. It determines the fitness function and generates the EV parameters at random after the initialization process (Fathy et al., 2023). The population of probable results in the HBA are indicated with mathematical formulas in Eq. 5.

$$\text{Population of candidate solution} = \begin{bmatrix} x_{11} & x_{12} & x_{13} & \dots & x_{1D} \\ x_{21} & x_{22} & x_{23} & \dots & x_{2D} \\ \dots & \dots & \dots & \dots & \dots \\ x_{n1} & x_{n2} & x_{n3} & \dots & x_{nD} \end{bmatrix}$$

$$i\text{th position of honey badger } x_i = [X_i^1, X_i^2, \dots, X_i^D] \quad (5)$$

**Step 1:** Initialization stage.

Eq. 6 computes the population size  $N$  and preliminary positions.

$$x_i = lb_i + r_1 \times (ub_i - lb_i), r_1 \text{ is a random number between 0 and 1} \quad (6)$$

Here,  $i_{th}$  badger signifies one probable resolution at location  $x_i$ , while lower bound is denoted as  $lb_i$  and upper bound is denoted as  $ub_i$ .

**Step 2:** Intensity

The intensity of the prey denotes their separation and connection with each other.  $I_i$  refers to the target of the trace strength as displayed in Eq. 7. In case of a strong smell, movement is quick.

$$I_i = r_2 \times \frac{S}{4\pi d_i^2}, r_2 \text{ is a random number between 0 and 1} \quad (7)$$

In Eq. 8,  $S$  refers to the source of honey which corresponds to the prey's position. The distance among prey and  $i_{th}$  badger is indicated as  $d_i$  which is referred in Eq. 9.

$$S = (x_i - x_{i+1})^2 \quad (8)$$

$$d_i = x_{prey} - x_i \quad (9)$$

**Step 3:** Update density factor

In order to provide a unified conversion from exploration to exploitation in the method, the density factor designated as  $\alpha$  introduces time-varying randomization. Iterative updates are made to the value of  $\alpha$ , which gets smaller over time. Eq. 10 is used to calculate this decreasing factor that lowers the level of randomization, as supplementary iterations are performed.

$$\alpha = C \times \exp\left(\frac{-t}{t_{max}}\right), t_{max} = \text{maximum number of iteration} \quad (10)$$

$C$  refers constant  $\geq 1$ .

**Step 4:** Avoidance from local best

To get around local optima areas, this step is used combine with the previous ones. The proposed algorithm includes a flag  $F$  that regulates the exploration route to address this. The algorithm allows the agents to search the space completely through direction change, which increases likelihood of finding excellent solutions.

**Step 5:** Modifying agent's position

The update of the IHBA position ( $x_{new}$ ), as formerly defined, involves two individual stages recognized as "digging" and "honey". The following steps provide a thorough justification.

Step 5-1 Digging stage

A badger makes signals that mirror the shape of cardioid during the digging phase. The mathematical representation shown in Eq. 11 is used to model the motion of the cardioid.

$$\mathbf{x}_{new} = \mathbf{x}_{prey} + \mathbf{F} \times \beta \times \mathbf{I} \times \mathbf{x}_{prey} + \mathbf{F} \times r_3 \times \alpha \times \mathbf{di} \times |\cos(2\pi r_4) \times [1 - \cos(2\pi r_5)]| \quad (11)$$

Here,  $x_{prey}$  signifies prey position, and  $\beta \geq 1$  indicates the badger's ability to obtain food. Whereas,  $r_3, r_4$ , and  $r_5$  represent three random values between 0 and 1.  $f$  operates as a flag that adjusts the search route which is defined by Eq. 12.

$$F = \begin{cases} 1 & \text{if } r_6 \leq 0.5 \\ -1 & \text{else,} \end{cases} \quad r_6 \text{ works among } 0 \& 1 \quad (12)$$

The behavior of the HB is significantly impacted by a number of elements during the digging period. These include the time-varying search influence factor  $\alpha$ . Moreover, the badger comes across  $F$ -designated disruptions while engaging in digging activities that enable it to choose a prey spot which is even more advantageous.

#### Step 5-2 Honey phase

$x_{new}$  signifies a new position, whereas  $x_{prey}$  characterizes the prey position. Eq. 13 displays the process of  $x_{new}$ ,

$$\mathbf{x}_{new} = \mathbf{x}_{prey} + \mathbf{F} \times r7 \times \alpha \times \mathbf{d}_i, \quad r_7 \text{ works among } 0 \& 1 \quad (13)$$

Distance is referred as  $d_i$ . In this step, the research behavior is influenced by the variable  $\alpha$ , which is a measure of how search habits have changed over time. The honey badger also has disruptions identified as  $F$ .

## 3.5 Improved Honey Badger Algorithm

Ultimately, the suggested method controls the energy in the EV system by calculating the best fitting values for the EV parameters, including battery SOC, engine torque, speed, and battery power. Reducing power loss while maintaining optimal energy management is the main goal of the suggested system. In addition, this article explores the cooperative assessment of EMS operation with various considerations during the suggested implementation of energy management according to IHBA, including the consequences of V2G/G2V uncertainty in EMS operation and trading features of EV arrival time in driving schedule of an EV. The badger's exploration phase in the initial HBA (Bishla and Khosla, 2023) begins with a local search in the methodology. The heart-shaped updating process causes this local search capability to be underwhelming. The update mode of HBA (Thumati et al., 2023) that is modulated by a random parameter  $R$ , is thereby strengthened by the introduction of a spiral motion mechanism. If  $R < 0.3$ , it is updated near the current location. Alternatively, as stated in Eq. 14, it is also updated towards the global optimal location.

$$\mathbf{X}_{updated} = \begin{cases} \mathbf{d}_j \cdot e^{bt} \cdot \cos(2\pi l) + \mathbf{X}_i & R < 0.3 \\ \mathbf{d}_j \cdot e^{bt} \cdot \cos(2\pi l) + \mathbf{X}_b & R \geq 0.3 \end{cases} \quad (14)$$

Where  $d_j$  refers the distance among the  $j^{th}$  badger and prey,  $b$  refers the logarithmic spiral shape constant,  $t$  refers the value between  $[-1, 1]$ ,  $X_{updated}$  refers to the updated location of the honey badger,  $X_i$  and  $X_b$  describe the current and global

optimal locations of the prey, respectively. The initial energy of the electric vehicle must be somewhat near to the final energies of the vehicle at the conclusion of the control horizon. When applying the optimal energy schedule repeatedly, this restriction is taken into account. Figure 4 shows the flowchart of IHBA model.

In this work, the load variance decrement is regarded as an objective function which is signified as Eq. 15.

$$\text{Minimize, Load Variance } (J) = \sum_{t=1}^T \frac{1}{T} (\text{Loads}(t) - \text{mean}(\text{Loads}))^2 \quad (15)$$

The arithmetic formulations for power and charge balance are specified in Eqs 16, 17, correspondingly.

$$P_{g,t} - P_{c,t} + P_{d,t} = P_{L,t} \quad (16)$$

Where,  $P_{L,t}$  is referred to as load demand, the load requirement from the grid at time  $t$  is denoted as  $P_{g,t}$ , whereas  $P_{c,t}, P_{d,t}$  correspondingly refer to the charging and discharging power.

$$\text{SOC}_t = \text{SOC}_{t-1} + \frac{P_{c,t} \Delta t \eta}{Q_{EV}} - \frac{P_{d,t} \Delta t \eta}{Q_{EV}} \quad (17)$$

Where,  $Q_{EV}$  stands for the battery capacity of EV, time interval is represented as  $\Delta t$ , whereas the efficiency of the storage charger is stated as  $\eta$ .

The pseudo-code of the recommended algorithm comprises population initialization, evaluation, and constraint updates which are provided in Algorithm 1.

### 3.5.1 Algorithm 1: pseudocode of IHBA

```

Set parameter  $t_{max}, N, \beta, C$ .
Initialize the population with positions.
Evaluate the fitness of each honey badger position  $x_i$  using objective function and assign to  $f_i, i \in [1, 2, \dots, N]$ .
Save best position  $x_{prey}$ , and assign fitness to  $f_{prey}$ .
while  $t \leq t_{max}$  do
    Update the decreasing factor  $\alpha$ .
    for  $i = 1$  to  $N$  do
        Calculate the intensity  $I_i$ .
        if  $r < 0.5$  then ▷  $r$  is random number between 0 and 1
            Update the position  $x_{new}$ .
        else
            Update the position  $x_{new}$ .
        end if
        Evaluate new position and assign to  $f_{new}$ .
        if  $f_{new} \leq \bar{f}$  then
            Set  $x_i = x_{new}$  and  $\bar{f} = f_{new}$ .
        end if
        if  $f_{new} \leq f_{prey}$  then
            Set  $x_{prey} = x_{new}$  and  $f_{prey} = f_{new}$ .
        end if
    end for
end while Stop criteria satisfied.
Return  $x_{prey}$ 

```

## 4 Result and discussion

In this study, experimental results are confirmed using MATLAB R2022b. The PV-EV grid evaluation is built and evaluated using a PC laboratory stand with Windows 11 and an



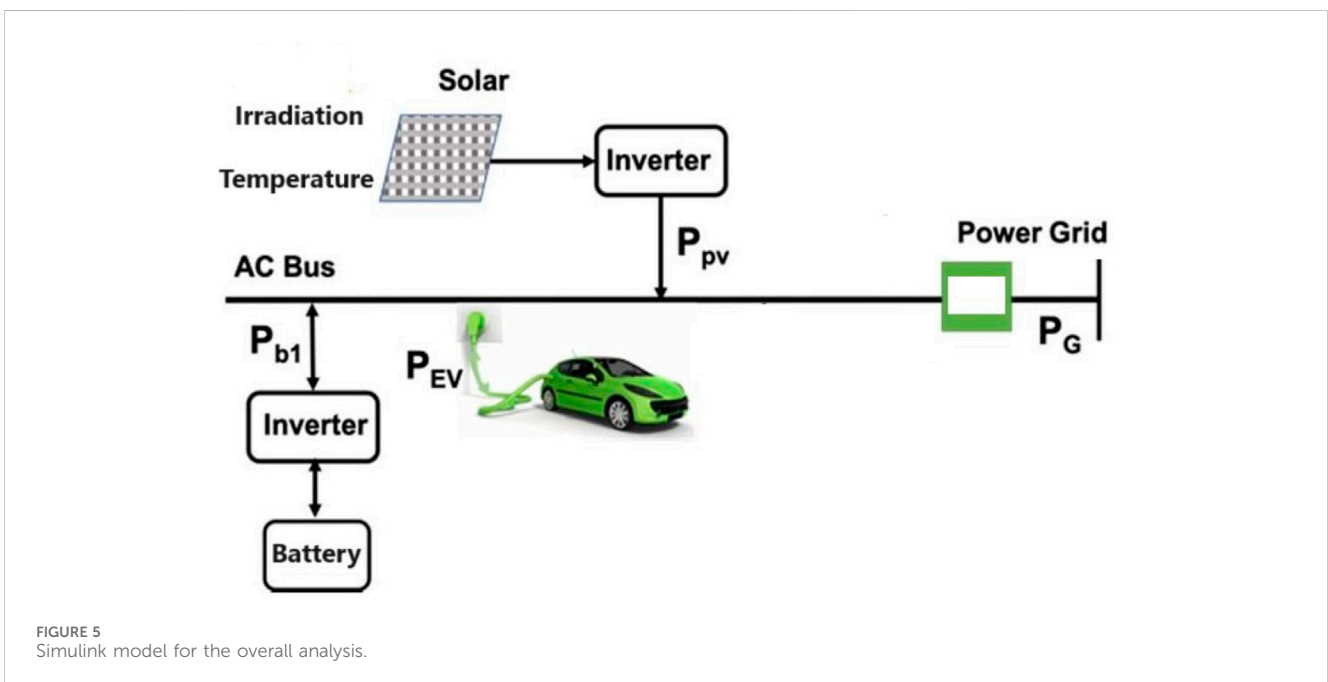
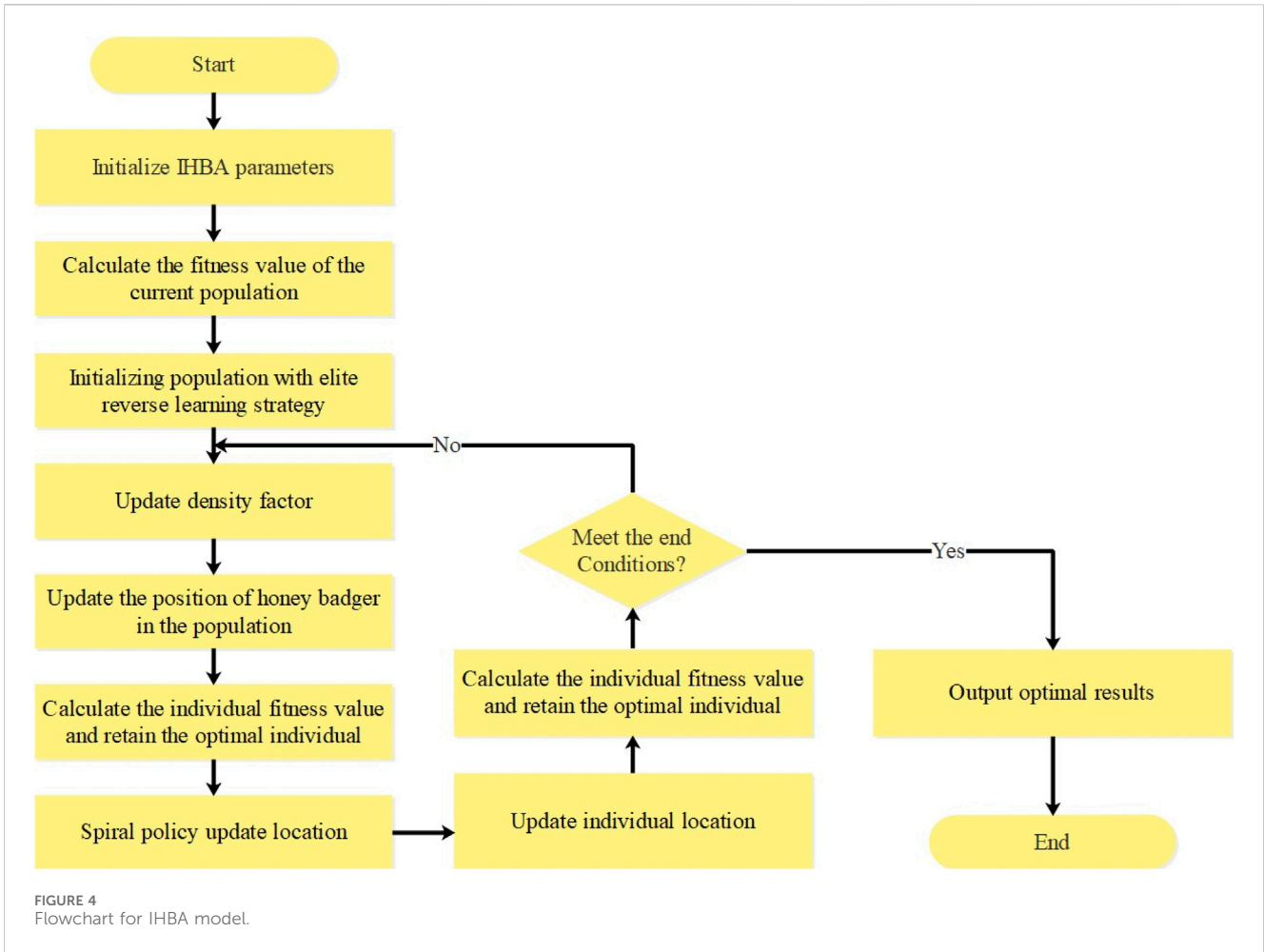

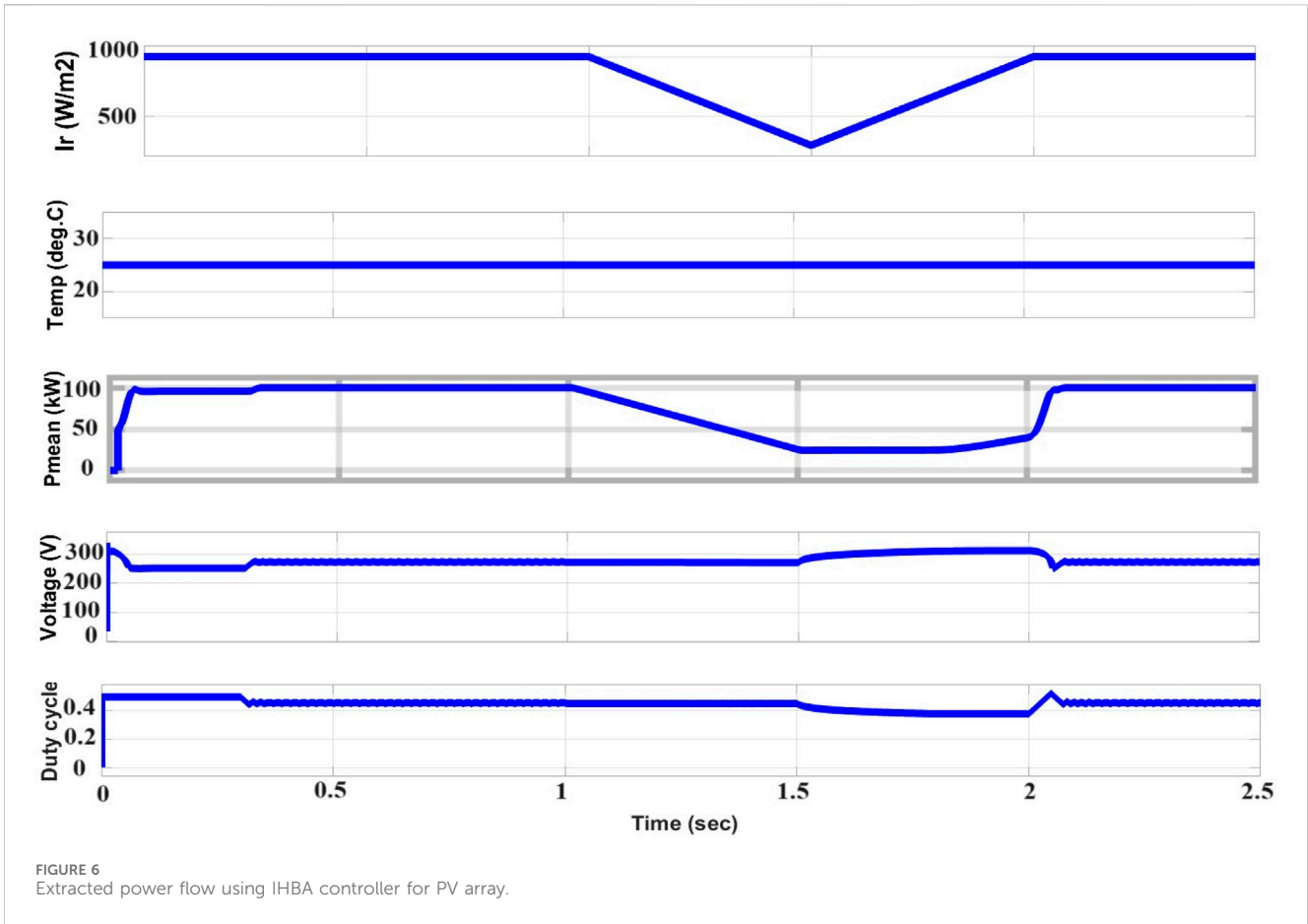

TABLE 1 Performance comparison of PV with different optimization methods.

Optimization methods	Generated power (kW)	MPP power (kW)	Precision (%)
WOA	81.64	83.46	91.13
EHO	84.46	86.72	95.47
IHBA	93.27	96.57	98.48

Intel Core i9 CPU as well as 32 GB of RAM. In this paper, various strategies for employing a charging station are created on smart grid conjunction to charge EVs throughout the day are described. IHBA is exploited to accomplish optimal design related with customary parameters included in the algorithm process. The recommended IHBA method is operated with constant value as 2, beta as 7, 50 collecting agents, 500 maximum iterations, 30-dimension, 30 population size, and EV consuming 15 kw/h for every 100 km to help the charging station provide continuous charge. The results show EV charging by employing the stated combination, and the recommended approach remains continuous during the charging phase, in contrast to the traditional grid-alone charging. The simulation depiction of entire analysis is revealed in Figure 5.

The findings demonstrate the necessity of utilizing smart technology to manage the charging of PHEVs for increasing the

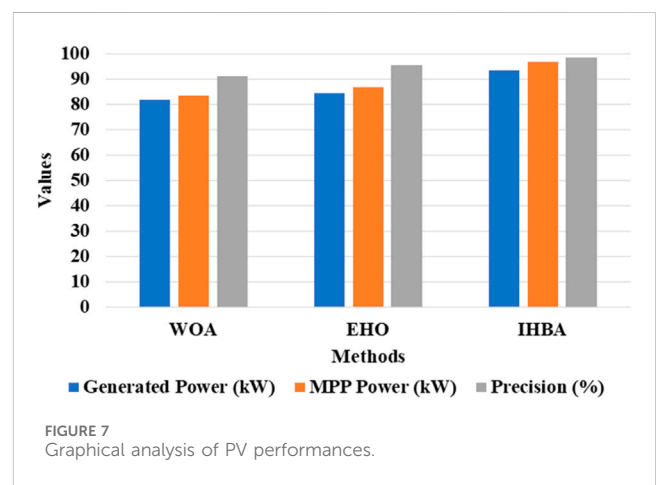
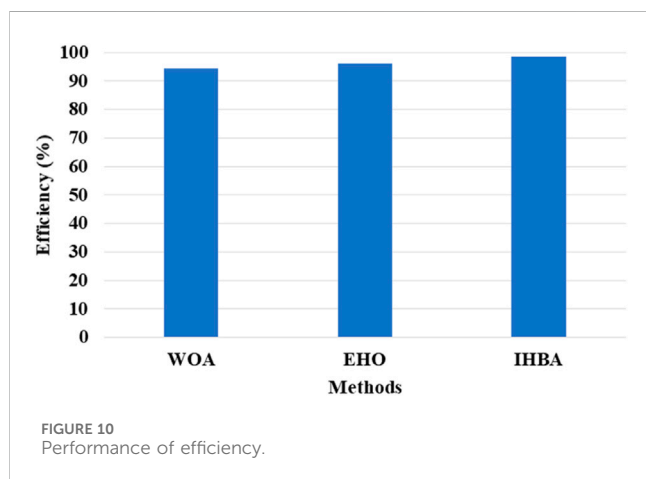
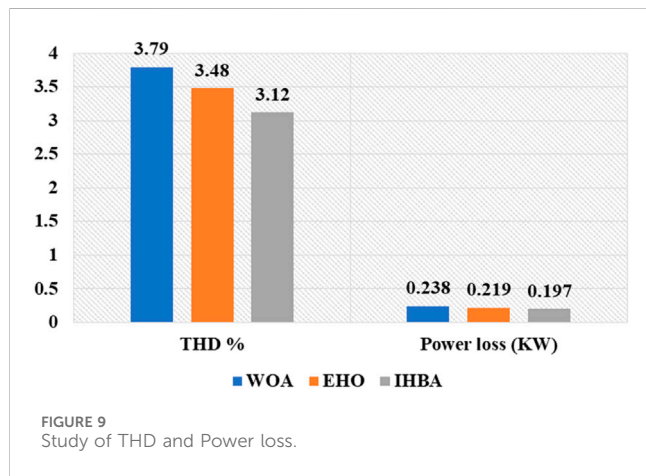
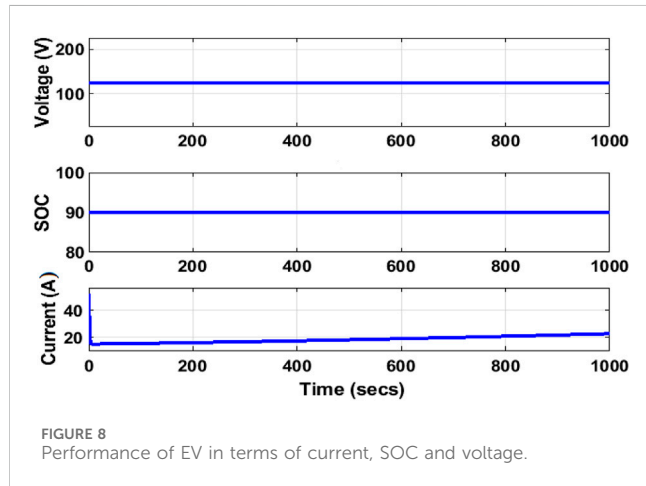

TABLE 2 Performance comparison of EV with different optimization methods.

Optimization methods	V_THD (%)	Efficiency (%)	Power loss (KW)
WOA	3.79	94.48	0.238
EHO	3.48	96.19	0.219
IHBA	3.12	98.47	0.197



superiority of electrical energy delivery. The power flow with respect to that PV array is extracted with the assistance of IHBA controllers which is shown in Figure 6. Additional performance metrics including voltage and duty cycle numbers are also shown in respective Figure 6.

By altering converter’s duty cycle to match necessary load at continuous output voltage, MPPT is employed to monitor MPP of PV panels. Consequently, a converter is used to rise the voltage which results in a new duty cycle value and drives PV to the peak MPPT level. The connected load will therefore affect how the MPPT value changes. Table 1 displays the MPPT precision and power results. It clearly shows that the suggested IHBA achieves an increased precision of 98.48%, which is better than traditional techniques, namely, Whale Optimization Algorithm (WOA) with 91.13% precision, and Elephant Herding Optimization (EHO) with 95.47% precision. Figure 7 shows the graphical analysis of PV performances.

According to the results from Table 1 and Figure 7, the IHBA controller outperforms the WOA and EHO controllers by achieving 96.57 kW MPP power. While EHO obtains the maximum power of 86.72 kW, the WOA controller obtains the maximum power of 83.46 kW.

To enhance this setup, the voltage source inverter must have a number of characteristics such as active power filtering and power factor change. Current harmonics produced by nonlinear loads interconnected to the grid degrade the efficiency of the power. To account for these armature currents, active power filters are used. Voltage regulation issues arise once PV is linked to the grid. The performance analysis through the waveform assessment of the voltage, SOC and current for EV is shown in Figure 8.

The converters must produce reliable, high-quality voltage in order to keep the voltage controlling apparatus from deteriorating. The computational method described in this paper that predicts a large number of inverter designs is used to identify the best battery presence organization. The SOC calculation protects the batteries from unexpected disruptions and prevents them from being overcharged, which possibly harms their interior predetermination.

Nodal voltages above the lower voltage limit results from a sudden decrease in PV output power. The utilization of renewable sources as well as the stability of distribution networks is severely impacted by nodal voltage fluctuations. As a result, there is growing interest in investigating advanced techniques for voltage regulation in distribution networks that contain large amounts of photovoltaic power. The benefit of the suggested voltage regulation method over the reference centralized techniques is that it accomplishes the same voltage control effect, while causing less distribution network loss. They are not required to alter their reactive outputs in order to use the suggested voltage regulation method. Table 2 compares the

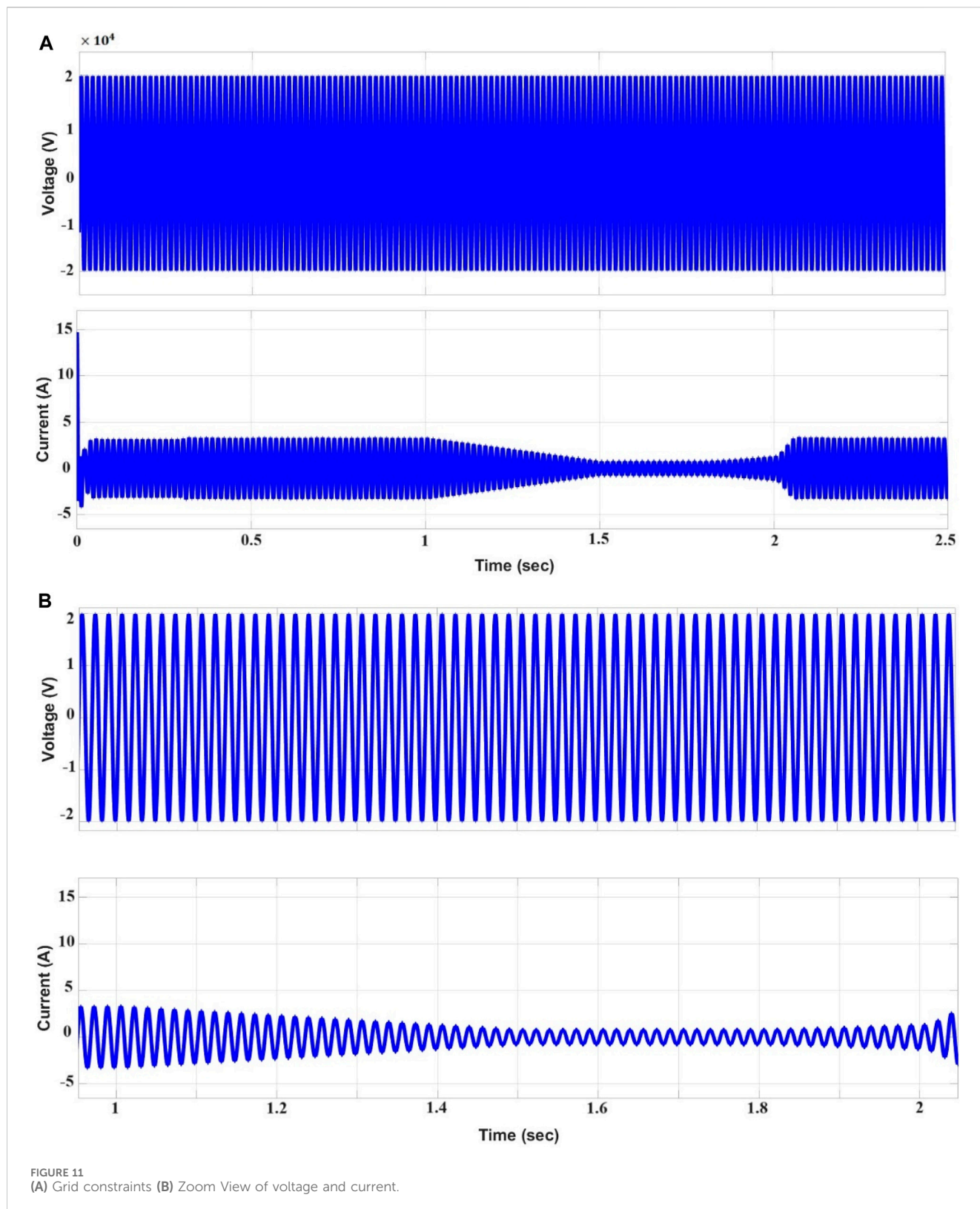

efficiency, power loss and THD voltage ( $V_{THD}$ ) results of various optimization techniques. Additionally, it provides more services on load with suitable charging conditions and a reduced voltage profile. Figure 9 displays the THD and power loss of the optimization methods, while Figure 10 displays the efficiency of proposed IHBA.

The voltage at DC-link does not have to be amplified throughout the design process above the input voltage. The recommended charger configuration offers an unusually broad output voltage spectrum while maintaining efficiency throughout the second phase. An internal parameter is used to indicate the concurrent power dissipation of all

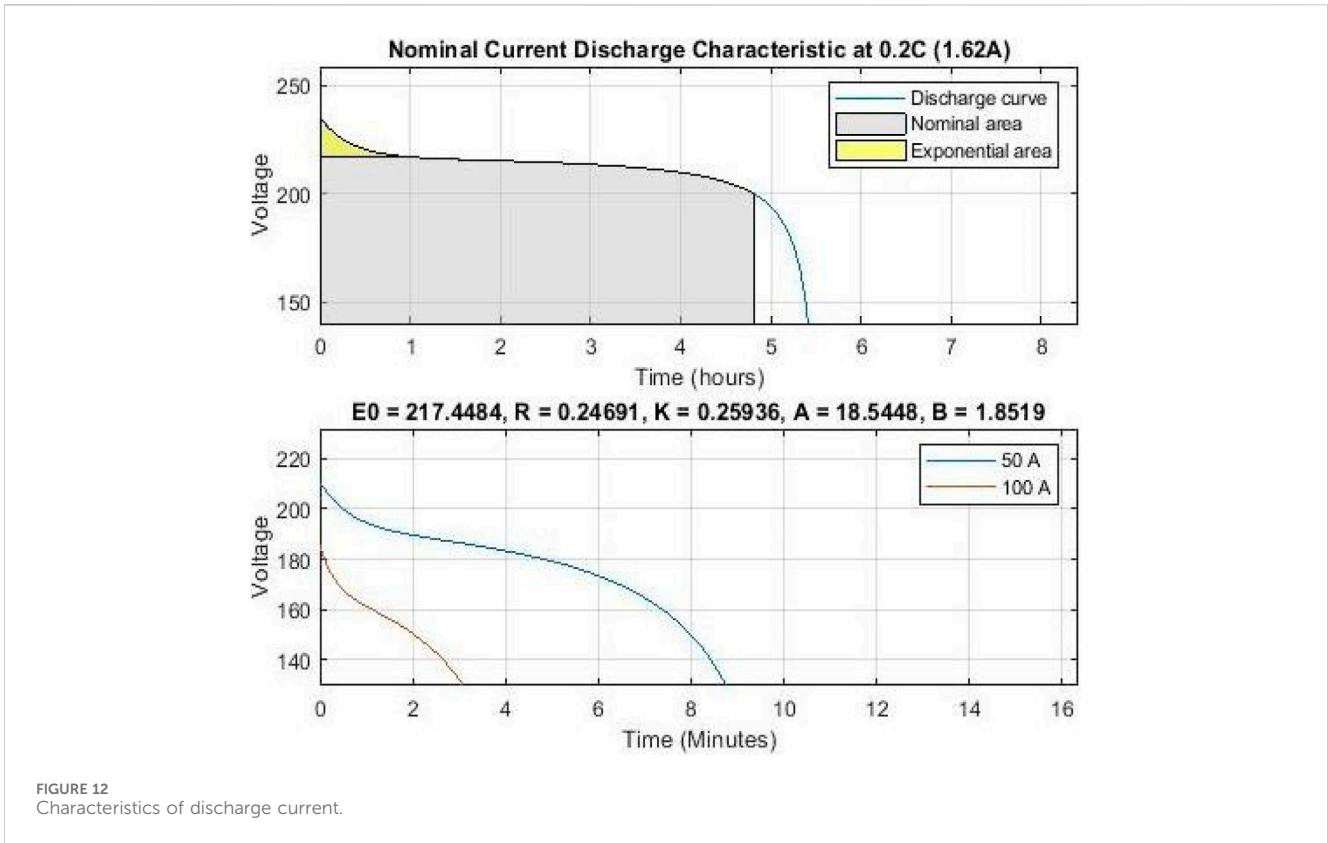

FIGURE 12 Characteristics of discharge current.

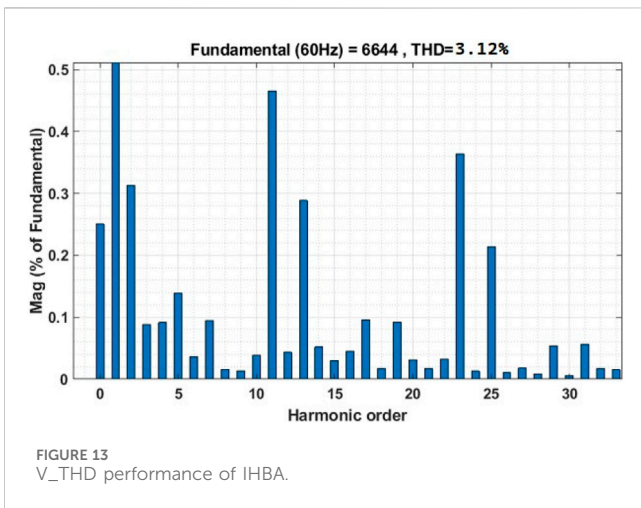

FIGURE 13 V\_THD performance of IHBA.

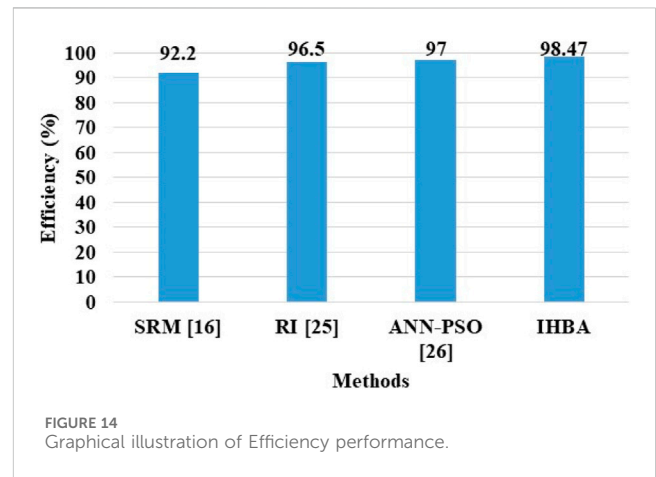

FIGURE 14 Graphical illustration of Efficiency performance.

of the semiconductor devices in the framework. The power that is quickly lost, only encompasses the potential power that the block releases. The values using a logarithmic model reflect the amount of power used by the component over time. This Efficiency function controls because the losses for elements through a particular power consumption value are recognized.

Figure 11A details the grid voltage and current limitations, whereas Figure 11B displays the grid parameters with zoomed-in detail. Under different lighting conditions, the device produces extreme amounts of energy by increasing grid current/voltage. MPPT initially chooses MPP to use a variety of controllers. Also, how the controller is used to manage peak loads in the grid side

using the projected RES is explained here. The architecture that arises is largely composed of accurate, thorough simulations of the outcomes of testing that are both challenging and secure. The approach has also been used to look at how Hybrid Renewable Energy Sources (HRES) changes behavior when there is an active shift in behavior. Figure 12 displays the battery's nominal current and discharge statistics.

In order to describe the nonlinear relationship between the State of Charge (SOC) and the voltage at the energy storage system's terminals, the graphical model (Figure 12) was created using Shepherd's equation. Figure 12 shows the discharge curve of a 1.62 Ah, 220 V nominal voltage battery from an initial fully charged condition to a final completely discharged state which

TABLE 3 Comparative study of various performances.

Performances	SRM (Cheng et al., 2020)	RI (Kanimozhi et al., 2022)	ANN-PSO (Nouri et al., 2024)	IHBA
Efficiency (%)	92.2	96.5	97	98.47
V_THD (%)	4.95	-	-	3.12

TABLE 4 Comparison of speed performance.

Performance	GA-PID (Guentri et al., 2021)	MHS (Al-Dhaifallah et al., 2021)	IHBA
Speed (km/hr.)	84	87	91

has a polynomial-shaped curve that represents the voltage time relationship. There are three main processes that occur in the voltage curve of a battery during charging/discharging, an exponential drop from full charge as the battery starts to discharge, a linear section about the rated voltage where the battery is typically operated, and a nonlinear section as the battery approaches its completely discharged state which are illustrated in Figure 12. Every portion that is highlighted is significant in conveying the features of the development of the energy storage system model. The impact of PHEVs on the power grid are reduced with the use of an appropriate controller, a smart charging system, and an effective management to transfer loads and avoid peaks. Each restriction in this case has a prior description in the anticipated section.

## 4.1 Comparative analysis

Furthermore, it is necessary to add extra parts such as converters or diode bridge rectifiers to the existing SRM (Cheng et al., 2020). The converter and rectifier are the two most crucial elements of the charger design. The current charger architecture does not include any new parts because it is more compact, less expensive, and better than other battery chargers. The architecture in (Cheng et al., 2020) is completely dependent on nonlinear equipment and needs to be put into separate engine coil plugs. Unlike other controllers, this one effectively accounts for the power loss of the traction machine. Figure 13 displays the V\_THD evaluation for the IHBA controller. Table 3 gives a clear evaluation of the proposed IHBA by comparing with the existing approaches such as SRM (Cheng et al., 2020), RI (Kanimozhi et al., 2022) and ANN-PSO (Nouri et al., 2024).

Figure 14 shows the graphical illustration of efficiency of the proposed method with existing methods such as SRM (Cheng et al., 2020), RI (Kanimozhi et al., 2022) and ANN-PSO (Nouri et al., 2024). From the Figure 14, it is evident that the existing SRM (Cheng et al., 2020), RI (Kanimozhi et al., 2022) and ANN-PSO (Nouri et al., 2024) obtain an efficiency of 92.2%, 96.5% and 97% respectively. The electrodynamic connection of multiphase equipment has an effect on PF, aside from the possible benefits of several methods that are greater than real SRM design (Cheng et al., 2020). The proposed methods have a lower THD than the existing methods. Although the motor impedance locations for distinct units differ, the integrated equipment retains the identical recharging aspect when using the proposed control strategy. Table 4 presents the comparison of speed performance.

Table 4 evidently displays that existing GA-PID (Guentri et al., 2021) and MHS (Al-Dhaifallah et al., 2021) reach a speed of 84 km/h and 87 km/h, separately, whereas the IHBA obtains a superior value of 91 km/h that is much farther than the remaining approaches.

## 4.2 Discussion

An Improved Honey Badger algorithm (IHBA) is suggested in this study to integrate SGs with solar panels, an EV parking lot, and dynamic loads at the PCC. The suggested IHBA makes use of forecasts of PV generation to optimize the G2V or V2G charging profiles of the EVs through the use of dynamic programming. This algorithm minimizes SG effectiveness and takes user preferences into account while reducing reliance on the grid. The results of the study demonstrate the effectiveness of the Honey Badger approach in resolving problems involving large search spaces. To accomplish a balanced grid load profile, a smart charging algorithm is developed and evaluated in the MATLAB environment to optimize EV charging and discharging. In the result analysis, the proposed IHBA is compared with existing approaches such as SRM (Cheng et al., 2020), RI (Kanimozhi et al., 2022) and ANN-PSO (Nouri et al., 2024) in terms of efficiency and V\_THD. The existing SRM (Cheng et al., 2020), RI (Kanimozhi et al., 2022) and ANN-PSO (Nouri et al., 2024) has achieved an efficiency of 92.2%, 96.5% and 97% respectively, while proposed IHBA accomplished higher value of 98.47% with V\_THD of 3.12%. The proposed IHBA accomplished a higher speed range of 91 km/h, which is superior over existing GA-PID (Guentri et al., 2021) and MHS (Al-Dhaifallah et al., 2021) obtained 84 km/h and 87 km/h, individually. Even though, all optimization algorithms, does not always provide the best solutions to specific problems. Furthermore, while some optimization techniques do work, more needs to be done to increase their efficacy. To further advance the field of heuristic optimization, new optimization techniques inspired by nature must constantly be developed because the problem of how to speed up an algorithm's convergence is still very challenging.

## 5 Conclusion

This article has confirmed that exploitation of advanced technologies would permit the adoption of EVs into SG model. In such condition, SG could increase the effectiveness of EV for

assisting the utility grid. After that, this paper has looked into the relationship between the SG and EVs in extensive detail. In this work, a novel EMS for smart grid, PV systems, and EV parking lots was developed. Users of the parking lot could select from four charging modes offered by the management system, and the EV elements that must be taken into account while choosing a charging mode were developed. By efficiently searching the search space while avoiding unacceptable areas, the proposed EMS was assessed by the IHBA to create a balance between exploration and exploitation capabilities. Considering the exact same setup, the IHBA is compared with a number of optimization strategies, such as the WOA and EHO. The findings of this study show that the honey badger algorithm is successful in resolving issues with intricate search spaces. According to obtained results, the IMO controller outperformed the WOA and EHO controllers in terms of total harmonic distortion voltage (3.12%), power loss (0.197 kW) and efficiency (98.47%). Its supremacy in terms of convergence speed and striking a healthy balance among exploration and exploitation are also supported by the empirical study. In order to tackle the large-scale optimization problems, future studies will concentrate on strengthening the IHBA by including chaotic maps as well as binary and multi-objective characteristics.

## Data availability statement

The original contributions presented in the study are included in the article/supplementary material, further inquiries can be directed to the corresponding authors.

## References

- Al-Abri, T., and Albadi, M. (2022). "Impacts of electric vehicles on distribution system planning and operation," in 20th International Conference on Renewable Energies and Power Quality (ICREPQ'22); 2022, Vigo, Spain (Renewable Energy Power Qual. J.), 313–317. doi:10.24084/repq20.296
- Al-Dhaifallah, M., Ali, Z. M., Alanazi, M., Dadfar, S., and Fazaeli, M. H. (2021). An efficient short-term energy management system for a microgrid with renewable power generation and electric vehicles. *Neural. comput. Appl.* 33 (23), 16095–16111. doi:10.1007/s00521-021-06247-5
- Bishla, S., and Khosla, A. (2023). Honey badger optimized energy management in grid connected solar PV battery for enhancing the stability and power quality. *Energy Storage* 6. e512. doi:10.1002/est2.512
- Bot, Y., Yousfi, A., and Allali, A. (2022). Smart control of the bidirectional energy exchange of electric vehicles with the electrical network. *Int. J. Adv. Stud. Comput. Sci. Eng.* 11 (12), 29–35.
- Chen, R.-F., Luo, H., Huang, K.-C., Nguyen, T.-T., and Pan, J.-S. (2022). An improved honey badger algorithm for electric vehicle charge orderly planning. *J. Netw. Intell.* 7 (2), 332–346.
- Cheng, H., Wang, Z., Yang, S., Huang, J., and Ge, X. (2020). An integrated SRM powertrain topology for plug-in hybrid electric vehicles with multiple driving and onboard charging capabilities. *IEEE Trans. Transp. Electrification* 6 (2), 578–591. doi:10.1109/TTE.2020.2987167
- Düzenli, T., Onay, F. K., and Aydemir, S. B. (2022). Improved honey badger algorithms for parameter extraction in photovoltaic models. *Optik* 268, 169731. doi:10.1016/j.ijleo.2022.169731
- Egbue, O., Uko, C., Aldubaisi, A., and Santi, E. (2022). A unit commitment model for optimal vehicle-to-grid operation in a power system. *Int. J. Electr. Power Energy Syst.* 141, 108094. doi:10.1016/j.ijepes.2022.108094
- Fathy, A., Rezk, H., Ferahtia, S., Ghoniem, R. M., and Alkanhel, R. (2023). An efficient honey badger algorithm for scheduling the microgrid energy management. *Energy Rep.* 9, 2058–2074. doi:10.1016/j.egyrs.2023.01.028
- Gan, W., Wen, J., Yan, M., Zhou, Y., and Yao, W. (2024). Enhancing resilience with electric vehicles charging redispatching and vehicle-to-grid in traffic-

## Author contributions

GS: Investigation, Resources, Writing–original draft. RK: Data curation, Visualization, Writing–original draft. PF-G: Funding acquisition, Validation, Writing–review and editing. PB: Formal Analysis, Supervision, Writing–review and editing. RK: Conceptualization, Software, Writing–review and editing.

## Funding

The author(s) declare that no financial support was received for the research, authorship, and/or publication of this article.

## Conflict of interest

The authors declare that the research was conducted in the absence of any commercial or financial relationships that could be construed as a potential conflict of interest.

## Publisher's note

All claims expressed in this article are solely those of the authors and do not necessarily represent those of their affiliated organizations, or those of the publisher, the editors and the reviewers. Any product that may be evaluated in this article, or claim that may be made by its manufacturer, is not guaranteed or endorsed by the publisher.

electric networks. *IEEE Trans. Ind. Appl.* 60 (1), 953–965. doi:10.1109/TIA.2023.3272870

Grasel, B., Baptista, J., and Tragner, M. (2023). "The impact of V2g charging stations (active power electronics) to the higher frequency grid impedance," in 2023 International Conference on Smart Energy Systems and Technologies (SEST); 2023, Mugla, Turkiye (IEEE), 1–6. doi:10.2139/ssrn.4528053

Guentri, H., Allaoui, T., Mekki, M., and Denai, M. (2021). Power management and control of a photovoltaic system with hybrid battery-supercapacitor energy storage based on heuristics methods. *J. Energy Storage* 39, 102578. doi:10.1016/j.est.2021.102578

Hashim, F. A., Houssein, E. H., Hussain, K., Mabrouk, M. S., and Al-Atabany, W. (2022). Honey Badger Algorithm: new metaheuristic algorithm for solving optimization problems. *Math. Comput. Simul.* 192, 84–110. doi:10.1016/j.matcom.2021.08.013

He, T., Lu, D.D.-C., Wu, M., Yang, Q., Li, T., and Liu, Q. (2021). Four-quadrant operations of bidirectional chargers for electric vehicles in smart car parks: G2V, V2G, and V4G. *Energies* 14, 181. doi:10.3390/en14010181

İnci, M., Savrun, M. M., and Çelik, Ö. (2022). Integrating electric vehicles as virtual power plants: a comprehensive review on vehicle-to-grid (V2G) concepts, interface topologies, marketing and future prospects. *J. Energy Storage* 55 (B), 105579. doi:10.1016/j.est.2022.105579

Ismail, A. A., Mbungu, N. T., Elnady, A., Bansal, R. C., Hamid, A.-K., and AlShabi, M. (2023). Impact of electric vehicles on smart grid and future predictions: a survey. *Int. J. Modell. Simul.* 43 (6), 1041–1057. doi:10.1080/02286203.2022.2148180

Justin, F., Peter, G., Stonier, A. A., and Ganji, V. (2022). Power quality improvement for vehicle-to-grid and grid-to-vehicle technology in a microgrid. *Int. Trans. Electr. Energy Syst.* 2022, 1–17. doi:10.1155/2022/2409188

Kanimozhi, G., Natrayan, L., Angalaeswari, S., and Paramasivam, P. (2022). An effective charger for plug-in hybrid electric vehicles (PHEV) with an enhanced PFC rectifier and ZVS-ZCS DC/DC high-frequency converter. *J. Adv. Transp.* 2022, 1–14. doi:10.1155/2022/7840102

Karoń, G. (2022). Energy in smart urban transportation with systemic use of electric vehicles. *Energies* 15, 5751. doi:10.3390/en15155751

- Kumar, M. P., Kumaraswamy, D., Jayanth, R., Rohith, K., Rakesh, G., Teja, S. M., et al. (2022). Vehicle-to-grid technology in a micro-grid using DC fast charging architecture. *J. Eng. Sci.* 13 (07), 291–295.
- Kumari, A., Trivedi, M., Tanwar, S., Sharma, G., and Sharma, R. (2022). SV2G-ET: a secure vehicle-to-grid energy trading scheme using deep reinforcement learning. *Int. Trans. Electr. Energy Syst.* 2022, 1–11. doi:10.1155/2022/9761157
- Liu, S., Xin, D., Yang, L., Li, J., and Wang, L. (2020). A hierarchical V2G/G2V energy management system for electric-drive-reconstructed onboard converter. *IEEE Access* 8, 198201–198213. doi:10.1109/ACCESS.2020.3034968
- Liu, Z., Wu, Y., and Feng, J. (2023). Competition between battery switching and charging in electric vehicle: considering anticipated regret. *Environ. Dev. Sustain.* doi:10.1007/s10668-023-03592-4
- Madhavaram, P. R., and Manimozhi, M. (2022). Smart energy management strategy for microgrids powered by heterogeneous energy sources and electric vehicles' storage. *Energies* 15 (20), 7739. doi:10.3390/en15207739
- Makeen, P., Ghali, H. A., Memon, S., and Duan, F. (2023). Insightful electric vehicle utility grid aggregator methodology based on the G2V and V2G technologies in Egypt. *Sustainability* 15, 1283. doi:10.3390/su15021283
- Mojumder, M. R. H., Ahmed Antara, F., Hasanuzzaman, M., Alamri, B., and Alsharef, M. (2022). Electric vehicle-to-grid (V2G) technologies: impact on the power grid and battery. *Sustainability* 14, 13856. doi:10.3390/su142113856
- Nouri, A., Lachheb, A., and El Amraoui, L. (2024). Optimizing efficiency of Vehicle-to-Grid system with intelligent management and ANN-PSO algorithm for battery electric vehicles. *Electr. Power Syst. Res.* 226, 109936. doi:10.1016/j.epsr.2023.109936
- Rahman, A., Ali, M., Aamir, M., Mumtaz, M., Khan, H. S., and Waqar, A. (2018). "Design and analysis of efficient battery charging/discharging for V2G and G2V application," in 2018 2nd International Conference on Energy Conservation and Efficiency (ICECE); 2018, Lahore, Pakistan (IEEE), 6–13. doi:10.1109/ECE.2018.8554977
- Raju, K., Siraj, S. K. B., Venkatesh, M., Wesley, J. J., Madhu, V., and Srinivasarao, V. V. (2023). Vehicle-to-grid technology in a micro-grid using DC fast charging architecture. *J. Eng. Sci.* 14 (05), 681–688.
- Spanoudakis, N. I., Akasiadis, C., Iatrakis, G., and Chalkiadakis, G. (2023). Engineering IoT-based open MAS for large-scale V2G/G2V. *Systems* 11, 157. doi:10.3390/systems11030157
- Sureshkumar, V., Mugunthan, S., and Amin, R. (2022). An enhanced mutually authenticated security protocol with key establishment for cloud enabled smart vehicle to grid network. *Appl* 15 (5), 2347–2363. doi:10.1007/s12083-022-01350-3
- Thirugnanam, K., Yuen, C., Kumar, P., Ghaoud, T., and Sgouridis, S. (2023). Coordinated control strategy for vehicle-to-grid support at distribution node. *IET Smart Grid* 6 (2), 158–174. doi:10.1049/stg2.12086
- Thumati, S., Vadivel, S., and Rao, M. V. G. (2023). Optimal integration of photovoltaic public charging stations in multi-consumer electrical distribution system using improved honey badger algorithm. *Int. J. Intelligent Eng. Syst.* 16 (6), 482–491. doi:10.22266/ijies2023.1231.40
- Tirunagari, S., Gu, M., and Meeghapola, L. (2022). Reaping the benefits of smart electric vehicle charging and vehicle-to-grid technologies: regulatory, policy and technical aspects. *IEEE Access* 10, 114657–114672. doi:10.1109/ACCESS.2022.3217525
- ur Rehman, U. (2022). A robust vehicle to grid aggregation framework for electric vehicles charging cost minimization and for smart grid regulation. *Int. J. Electr. Power Energy Syst.* 140, 108090. doi:10.1016/j.ijepes.2022.108090
- Zhang, L., Sun, C., Cai, G., and Koh, L. H. (2023a). Charging and discharging optimization strategy for electric vehicles considering elasticity demand response. *eTransportation* 18, 100262. doi:10.1016/j.etrans.2023.100262
- Zhang, L., Yin, Q., Zhu, W., Lyu, L., Jiang, L., Koh, L. H., et al. (2023b). Research on the orderly charging and discharging mechanism of electric vehicles considering travel characteristics and carbon quota. *IEEE Trans. Transp. Electrification*, 1. doi:10.1109/TTE.2023.3296964