

## INVESTIGATION OF RTS NOISE IN REVERSE POLARIZED SILICON CARBIDE SCHOTTKY DIODES

Arkadiusz SZEWCZYK, Barbara STAWARZ-GRACZYK

Gdansk University of Technology, Faculty of Electronics, Telecommunications and Informatics  
Department of Metrology and Optoelectronics, 11/12 G. Narutowicza Street, 80-233 Gdansk, Poland  
tel: 58 347 14 84 fax: 58 348 63 73 e-mail: szewczyk@eti.pg.gda.pl

**Abstract:** One of the method of electronic device quality and reliability evaluation is observation of its inherent noise. Generally, the inherent noise of semiconductor device consists of Gaussian (i.e.  $1/f$ , shot noise) and non-Gaussian components (i.e. random telegraph signal, RTS). The RTS phenomena usually indicates the presence of large defects in the structure of the material of the device, therefore it can be treated as an indicator of technology quality. In the paper authors present results of RTS investigations in reverse polarized Silicon Carbide Schottky diodes. Devices being studied are commercially available diodes with reverse voltage  $U_R = 600$  V. The RTS was observed during device stress by applying high voltage for several minutes and the change in signal parameters were studied.

**Key-words:** RTS noise, Schottky diodes.

### 1. INTRODUCTION

A lot of investigations which were carried out in the past proved that there is a very strong relation between the quality of semiconductor devices and the level of their inherent noise at low and very low frequencies. That is why one of the method of electronic devices quality and reliability evaluation is observation of its inherent noise. It can be defined on the basis of identification of two components: the Gaussian one whose instantaneous values of low frequency noise have Gaussian distribution, shortly named "Gaussian" component (i.e. thermal, shot and  $1/f$  noise) and non-Gaussian one whose instantaneous values of low frequency noise have non-Gaussian distribution, shortly named "non-Gaussian" component (i.e. random telegraph signal, RTS) [1, 2, 3].

The RTS phenomena usually indicates the presence of large defects in the structure of the material of the device, therefore it can be treated as an indicator of technology quality. If the device under test generates the RTS noise it means that this device is a poor quality one and it should be eliminated from applications. The RTS noise signal can be described by parameters such as  $\tau_{u,s}$  (the impulse duration in the up state for  $s = 1, 2, \dots, S$ ),  $\tau_{d,p}$  (the impulse duration in the down state for  $p = 1, 2, \dots, P$ ),  $\Delta X$  (the pulse amplitude),  $\bar{\tau}_u$  (the mean time the impulse remains in up state),  $\bar{\tau}_d$  (the mean time the impulse remains in down

state) and  $f_{RTS}$  (the characteristic frequency). The last parameter can be estimated from the noise spectrum as the frequency when the plateau comes into  $1/f^2$  and is equal:

$$f_{RTS} = \frac{1}{2\pi} \cdot \frac{1}{\tau} = \frac{1}{2\pi} \cdot \left( \frac{1}{\tau_d} + \frac{1}{\tau_u} \right) \quad (1)$$

The spectrum of a pure two-level RTS signal is Lorentzian and it is given by the following relation [4]:

$$S_{RTS} = \frac{4(\Delta A)^2}{1 + (2\pi \frac{f}{f_{RTS}})^2} \quad (2)$$

The RTS noise can be caused by a single generation-recombination center (two-level RTS noise) or by generation-recombination centers (multilevel RTS noise). A typical time record of two-level RTS noise is presented in figure 1.

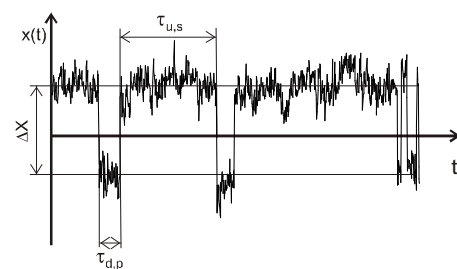

Fig. 1. Two-level RTS noise

The RTS noise can be identified in time domain as well as in frequency domain. In the time domain one can observe the noise signal i.e. using an oscilloscope, estimate the histogram of instantaneous noise values or apply the Noise Scattering Pattern (NSP) method presented in [5, 6, 7]. On the other hand in frequency domain the RTS noise can be identified by estimating the power spectral density (PSD) function of a noise signal or by estimating the product of PSD and a frequency. Although, as mentioned above there are many methods which allow to identify the RTS noise in semiconductor devices in different ways, during the presented below Schottky diodes investigations authors chose NSP method which was applied to analyze signal records. The NSP is very fast and simple method that allows

to identify the RTS signal and its nature. One of its advantages is that RTS noise can be identified using small number of noise samples.

## 2. DEVICES BEING STUDIED

The devices investigated in this study are commercially available silicon carbide Schottky diodes of CREE (CSD02060, CSD04060) [8] and Infineon (SDT04S60) [9] with forward current  $I_D = 2 \text{ A} / 4 \text{ A}$  and reverse voltage  $U_R = 600 \text{ V}$ .

Silicon carbide, SiC, is a novel material for power electronics. It offers higher band gap, higher breakdown electric field and higher thermal conductivity in comparison to other materials as silicon or gallium arsenide. The semiconductor devices made of this material as switching and power and HF devices, can work at higher switching frequencies and higher junction temperature, up to

175°C [10]. Due to its high thermal conductivity, SiC is widely used in power LEDs and other power devices as a material for substrate.

## 3. MEASUREMENT SET-UP

During the studies, the DC and noise characteristics were measured. DC characteristics were measured in both forward and reverse polarization. Characteristics in forward polarization were measured using standard oscilloscope method with a digital oscilloscope with memory in the measurement set-up in order to store the measurement results for further analysis.

The reverse characteristics were measured point by point using high voltage supply, voltmeter and amperemeter.

The low frequency noise was observed in the measurement set-ups shown in figure 2.

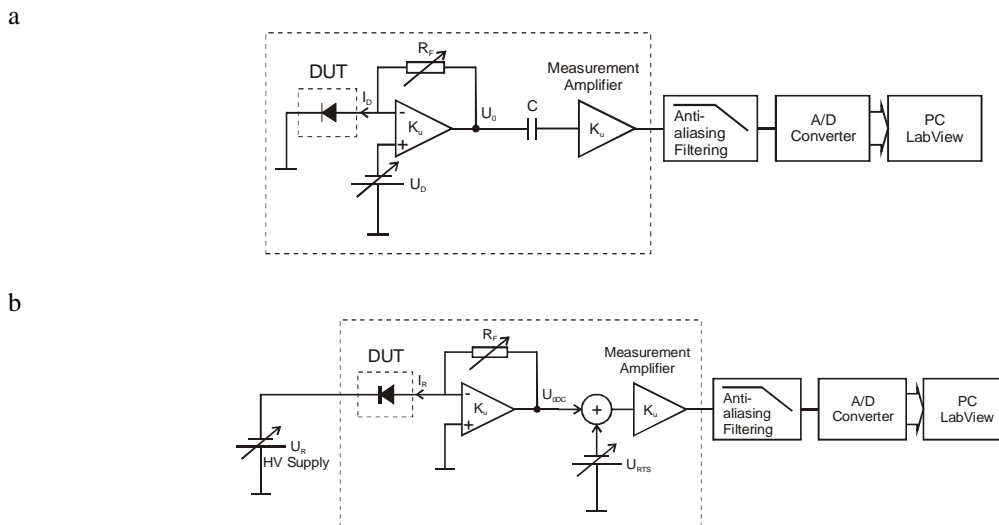

Fig. 2. Measurement set-up for noise observation in forward polarization (a) and in reverse polarization (b)

The measurement set-up consists of power supply,  $U_D$  and  $U_R$  for device biasing in forward and reverse direction respectively, device under test, DUT, the current to voltage converter, voltage amplifier and the components responsible for signal digitising and store: anti-aliasing filter, analogue-to-digital converter and computer with LabView software. Moreover, the measurement set-up for reverse polarization measurements is equipped with the voltage adder that replaces RC high-pass filter (represented by component "C" in figure 2a commonly used in a typical noise measurement set-up for a separation of DC component of the output noise signal of the current to voltage converter. Application of RC filter for separation of the DC component limits the frequency bandwidth of the set-up at low frequency, which is inadvisable for measurement of RTS-like signal, as the mean value of the signal randomly changes in time. The RC filter cause signal differentiation and the shape of the RTS is changed into the form shown in figure 3. Such a phenomena is critical especially for signals with long duration of pulses. The duration of the pulse that can pass the filter without deformation depends on the time constant of the RC filter. The deformation of the RTS shown in figure 3 complicates the signal analysis, even the identification of the RTS component is difficult, as the histogram and NSP method will give the false results. Also the calculation of the pulses duration will

require additional operations for indicating pulses start and end moments

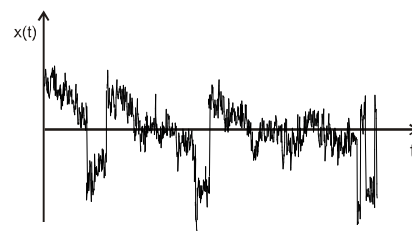

Fig. 3. Deformation of the RTS caused by RC filtering

The DC component at the output of current to voltage converter is proportional to DC diode current and for circuit shown in figure 2b it is equal to  $U_{oDC} = -I_R \cdot R_f$ . The voltage adder allows to compensate the DC component  $U_{oDC}$  with  $U_{RTS}$ , and for  $U_{RTS} = -U_{oDC}$ , the DC component in the amplified signal at the input of measurement amplifier is equal to zero. Thus, using voltage adder allows to offset the DC component without any degradation of the shape of the RTS pulses.

## 4. RESULTS

First, in order to evaluate devices behaviour in conditions specified by the producer in the technical data, the DC characteristics were measured.

In forward polarization all studied devices showed excellent behavior. The  $I = f(U)$  characteristics had perfect reproducibility and were fully comparable with producers data.

In reverse polarization, characteristics of diodes showed a significant dispersion, however all tested devices met producers data: the highest measured reverse current was lower than typical values given in the technical data [8, 9, 11].

Next, the noise of devices were measured. Some of the noise measurement results had been presented in [11]. During current noise observation in reverse polarized diodes the strong discrete current switching was observed in several devices, mainly in high voltage polarization,  $U_R = 400 \text{ V} \div 700 \text{ V}$ . It means that the random telegraph signal (RTS) phenomena occurs in those devices. The occurrence of the RTS was not correlated with device reverse current.

For the RTS study the noise signal was sampled and stored in text files. Typical noise signal with distinct RTS is shown in figure 4.

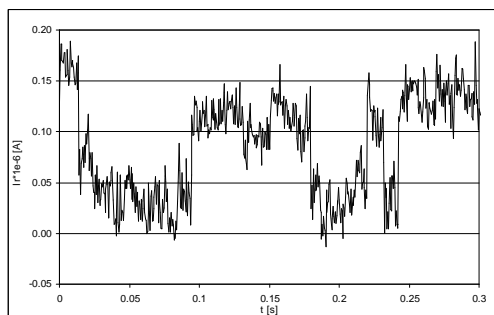

Fig. 4. RTS observed in reverse current of the CSD04060 diode at  $U_R = 600\text{V}$

The histogram and NSP chart for the data shown in figure 4 are shown in figure 5.

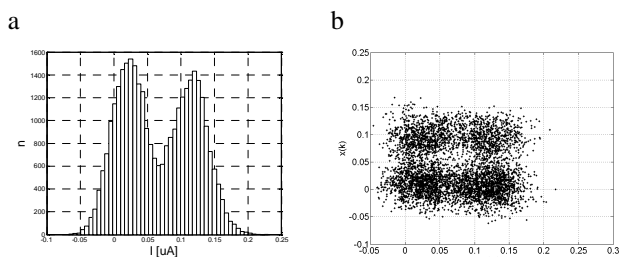

Fig. 5. Histogram (a) and NSP plot (b) for noise signal of the CSD04060 diode at  $U_R = 600 \text{ V}$

In order to establish the character of RTS, for devices the reverse biasing high voltage was applied for several minutes and the noise signal was observed. During the stress the RTS showed two behaviours: for some devices it stood almost unchanged, for others it changed. To examine changes of the RTS, the mean times of the signal up and down states was estimated. Figure 6 shows values of  $\overline{\tau}_u$  and  $\overline{\tau}_d$  for both types of devices during the stress. The data is for two different devices of the same type, in further called device A, for device with RTS remains unchanged and device B, for the one showing changes in RTS.

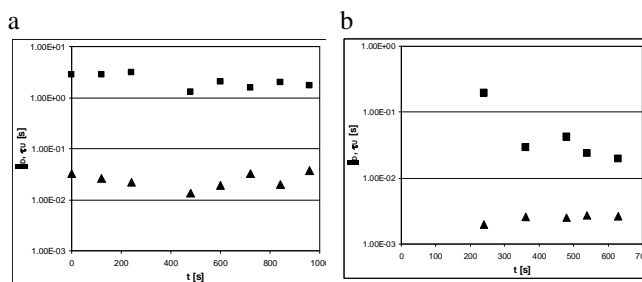

Fig. 6. Changes in mean times  $\overline{\tau}_u$  (squares) and  $\overline{\tau}_d$  (triangles) for (a) device the RTS remains constant (CSD02060 @ 500V) and (b) RTS parameters changed (CSD02060 @ 700V)

The lack of RTS changes is also visible in histograms and NSP charts corresponding to the data shown in figure 6a. as is seen in figure 7:

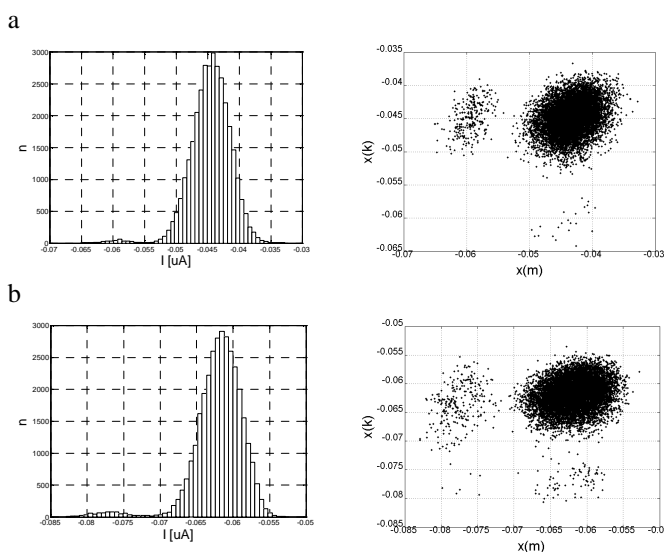

Fig. 7. Histogram and NSP chart for the data of device A at the beginning (a) and after 18 minutes of stress (b)

The device B shows different behaviour. At the beginning of the test the RTS component was not clearly visible in noise signal. The RTS appeared after a few minutes and changes during the test. Adequate histograms and NSP charts are shown in figure 8.

After removing stress and biasing diode in forward direction, the RTS was not visible in reverse current of the diode. This, and the character of changes observed in RTS, leads to the conclusion that, unlike in case of device A, the continues stress can cause downgrade of device quality and reliability. For device A, the stress has weak influence on defects existing in device structure. However more studies are required to be carried out in this subject.

## 5. CONCLUSIONS

The RTS phenomena was observed in several commercially available SiC Schottky diodes. Devices were reverse polarized with high voltage and the stress was applied for several minutes.

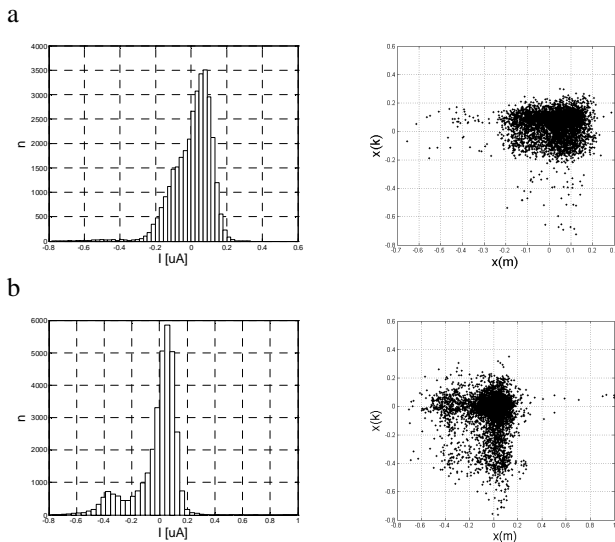

Fig. 8. Histogram and NSP chart for the data of device B at the beginning (a) and after 10 minutes of stress (b)

The RTS observation is a part of a device quality study. Devices showing a strong RTS phenomena are treated as devices with poor quality. The more complex analysis of the device quality with noise techniques requires taking into account the results of  $1/f$  noise measurements in conjunction with static parameters and characteristics. Also destroying tests are required (junction breakdown for diodes showing RTS and those that do not) in order to evaluate the effect of strong defects on device quality. Such an analysis will be proceeded after finishing all planned studies on these devices

## 6. REFERENCES

1. Konczakowska, A., Cichosz, J., Szewczyk, A., Stawarz, B.: Identification of optocoupler devices with RTS noise. *Fluctuation and Noise Letters*, vol. 6, no. 4, 2006, pp. L395–L404.

2. Stawarz-Graczyk, B., Dokupil, D., Flisikowski, P.: A method of RTS noise identification in noise signals of semiconductor devices in the time domain. *Metrology and Measurements Systems*, vol. XVII, no. 1, 2010, pp. 95-108.
3. Stawarz-Graczyk, B., Załęski, D., Konczakowska, A.: The automatic system for identification of random telegraph signal (RTS) noise in noise signals. *Metrology and Measurements Systems*, vol. XIV, no. 2, 2007, pp. 219-228.
4. Lal-Jadziak, J., Sienkowski, S.: Models of bias of mean square value digital estimator for selected deterministic and random signals. *Metrology and Measurements Systems*, vol. XV, no. 1, 2008, pp. 55–68.
5. Cichosz, J., Szatkowski, A.: Noise scattering patterns methods for recognition of RTS noise in semiconductor components. *Proc. of 18<sup>th</sup> Inter. Conference on Noise and Fluctuations – ICNF 2005*, Salamanca, Spain, 19-23 September 2005, Eds. T. Gonzalez, J. Mateos, D. Pardo, AIP Conference Proceedings, pp. 673–676.
6. Cichosz, J., Szatkowski, A.: The method for burst noise detection, particularly in semiconductor devices. Patent application P-375610, Polish Patent Office, 2005.
7. Konczakowska, A., Cichosz, J., Szewczyk, A.: A new method for RTS noise of semiconductor devices identification. *IEEE Transactions on Instrumentation and Measurement*, vol. 57, no. 6, 2008, pp. 1199-1206.
8. CREE Technical Data, <http://www.cree.com>
9. Infineon Technical Data, <http://www.infineon.com>
10. Agarwal, A., Singh, R., Ryu, S-H., Richmond, J., Capell, C., Schwab, S., et al. 600 V, 1- 40 A, Schottky Diodes in SiC and Their Applications. <http://www.cree.com/products/pdf/PWRTechnicalPaper1.pdf>.
11. Szewczyk, A., Stawarz-Graczyk, B.: Low Frequency Noise Measurement of Reverse Polarized Silicon Carbide Schottky Diodes. *20th International Conference on Noise and Fluctuations (ICNF-2009) Pisa, Italy*, AIP Conference Proceedings, 2009, pp. 645-648.

## BADANIE SZUMÓW RTS W DIODACH SiC SPOLARYZOWANYCH W KIERUNKU ZAPOROWYM

**Słowa kluczowe:** szумы RTS, diody Schottkiego.

**Streszczenie:** Jedną z metod do badania jakości i niezawodności elementów elektronicznych jest obserwacja ich szumów własnych, które zawierają składową gaussowską (szum typu  $1/f$ , szum śrutowy) oraz składową niegaussowską (szum RTS). Obecność szumu RTS zazwyczaj wskazuje na defekty w strukturze materiału, z którego jest wykonany element, ale jednocześnie może być doskonałym wskaźnikiem jakości badanego elementu. W artykule autorzy prezentują wyniki pomiarów w zaporowo spolaryzowanych diodach Schottkiego wykonanych z SiC. Badane elementy są powszechnie dostępnymi o  $U_R = 600$  V. Szum RTS był obserwowany po kilkuminutowym użytkowaniu badanego elementu w warunkach wysokiego napięcia.