

# INVESTIGATION OF THE CHARACTERISTICS OF A LOW-EMISSION GAS TURBINE COMBUSTION CHAMBER OPERATING ON A MIXTURE OF NATURAL GAS AND HYDROGEN

**Serhiy Serbin\***

Admiral Makarov National University of Shipbuilding, Ukraine

**Kateryna Burunsuz**

Admiral Makarov National University of Shipbuilding, Ukraine

**Daifen Chen**

Jiangsu University of Science and Technology, China

**Jerzy Kowalski**

Gdańsk University of Technology, Poland

\* Corresponding author: [serbin1958@gmail.com](mailto:serbin1958@gmail.com) (S. Serbin)

## ABSTRACT

*This article is devoted to the investigation of the characteristics of a low-emission gas turbine combustion chamber, which can be used in Floating Production, Storage and Offloading (FPSO) vessels and operates on a mixture of natural gas and hydrogen. A new approach is proposed for modelling the processes of burning out a mixture of natural gas with hydrogen under preliminary mixing conditions in gaseous fuel with an oxidizer in the channels of radial-axial swirlers of flame tubes. The proposed kinetic hydrocarbon combustion scheme is used in three-dimensional calculations for a cannular combustion chamber of a 25 MW gas turbine engine for two combustion models: the Finite-Rate/Eddy-Dissipation and the Eddy Dissipation Concept. It was found that, for the investigated combustion chamber, the range of stable operations, without the formation of a flashback zone in the channels of radial-axial swirlers, is determined by the hydrogen content in the mixture, which is less than 25-30% (by volume). For the operating modes of the chamber without the formation of a flashback zone inside the swirler channels, the emissions of nitrogen oxide NO and carbon monoxide CO do not exceed the values corresponding to modern environmental requirements for emissions of toxic components by gas turbine engines.*

**Keywords:** Gas turbine, Low-emission combustion chamber, Ecological parameters, Emission of toxic components

## INTRODUCTION

Research on the use of a mixture of natural gas and hydrogen, hydrogen-containing gases, and pure hydrogen in energy systems is relevant and promising. This is especially true of gas turbine technology, which is the basis of gas-transport networks, stationary energy systems, and marine energetics (its use in Floating Production, Storage and Offloading (FPSO) vessels in particular). The issue of converting gas turbine engines to alternative fuels, including a mixture of natural gas and hydrogen, synthesis and associated gases with high hydrogen content and pure hydrogen, has long been in the spotlight of researchers.

Note that the role of gas turbine engines in future low-carbon energy systems depends on achieving increased thermal efficiency and the ability to operate on fuels such as hydrogen. According to the International Energy Agency (IEA), the development of hydrogen-powered gas turbine technology could become the future carbon-neutral technology that supports society [1]. It should be noted that well-known world manufacturers of gas turbines (GE Power, Mitsubishi Heavy Industries, Siemens Energy, Rolls-Royce, Ansaldo Energia, etc.) have long been working fruitfully in this direction [2, 3]. In [2], Mitsubishi Heavy Industries presented the main stages of development of combustion chambers of gas turbine engines operating on hydrogen-containing gas

and hydrogen. An important aspect of the operation of gas turbine combustion chambers is the presence of thermoacoustic instability during the combustion of hydrogen-containing gases. In [3], the destabilising effect of hydrogen on the combustion dynamics of premixed mixtures was revealed. In [4] it was noted that the known combustion systems for gas turbine engines cannot be directly used for low-emission hydrogen combustion; it is recommended that special Micro-Mix technology is used with several diffusion-type burners to prevent flashback. Note that flashback usually occurs when the flame propagates towards the fresh gases upstream, at a velocity higher than the incoming flow velocity. The study by [5] considered the current state of mutual substitution of natural gas with a mixture of gases, with the addition of hydrogen to the flow of natural gas or methane. In [6], a combustion chamber operating on a mixture of methane and hydrogen was modelled to determine the optimal geometric configurations and operating conditions.

Preliminary computational fluid dynamics (CFD) modelling in [7] showed that the basic design scheme of a combustion chamber cannot safely operate on hydrogen fuel, as the flame propagates into the premix channel, which is not sufficiently protected from high temperatures. A new fuel injection system and a new geometry of the combustion chamber's front device are proposed. The study in [8] was devoted to the development of an analytical model for calculating the energy characteristics of a gas microturbine with power of 30 kW; a mixture of natural gas and hydrogen (0 to 10% by volume) was used as fuel. It was concluded that the use of up to 10% hydrogen in the mixture did not significantly change the behaviour of the gas microturbine. It was concluded in [9] that the low-emission combustion chambers (Dry Low NO<sub>x</sub> – DNL) available for natural gas burning in gas turbines cannot be directly applied to hydrogen combustion. Therefore, to significantly reduce emissions of nitrogen oxides (NO<sub>x</sub>), a new method for burning hydrogen fuel (DLN Micromix) has been proposed. This combustion principle is based on cross-flow mixing of air and gaseous hydrogen, which reacts in multiple miniaturised diffusion-type flames. The influence of various geometrical parameters on the flame structure and NO<sub>x</sub> emissions, as well as the determination of the most important energy characteristics of a chamber with the Micromix device operating on hydrogen, was considered in [12]. Parametric studies of a burner with a high energy density have shown that it is possible to positively influence the flame shape acting on the stabilising vortices. An adequate choice of the geometry of the front burner device allows one to adjust the flame length and the length of the inter shear layer, to suppress the formation of nitrogen oxides.

In [11], using numerical CFD methods, the parameters of a combustion chamber of a small-power gas turbine operating on pure methane and hydrogen were determined. There were significant differences in operating processes when burning different fuels, indicating possible problems and damage to burning components when operating on pure hydrogen. A new swirl injector design was proposed, which made it

possible to partially solve the problem of overheating of the combustion chamber's elements. The CFD modelling method was also used in [12], to study the processes of combustion of a hydrogen–air mixture in a microchamber. The separation of the hydrogen supply along a combustion chamber made it possible to significantly reduce the maximum wall temperature and reduce the non-uniformity of the temperature field at the outlet. CFD modelling of the reacting flow of air and hydrogen inside the flame tube of a diffusion-type combustion chamber of a single-shaft gas turbine is presented in [13]. Of interest are the calculations of the wall temperatures of the combustion chamber elements and the unevenness of the temperature field at the turbine inlet, since these parameters affect the reliability of components originally designed to operate on natural gas. To confirm the numerical results, data from full-scale experimental tests are used. Using the Ansys Fluent software package, 3D calculations of a simple geometry combustion chamber operating on methane or hydrogen were carried out in [14]. It was indicated that there are no carbon monoxide (CO) emissions during the combustion of hydrogen, in contrast to the combustion of methane. Large temperatures and velocities were observed in the combustion zone when hydrogen was used as a fuel.

Therefore, although the mechanisms of hydrogen fuel combustion are sufficiently developed, when converting real gas turbine engines to hydrogen-containing fuel, there are several problems. These are primarily associated with the thermophysical properties of hydrogen, such as: an increase in the flame propagation velocity and the possibility of the formation of a flashback zone (this is especially true for combustion chambers with preliminary mixing of components), an increase in the temperature of the flame tube walls due to an increase in heat release, and possible growth in nitrogen oxide emissions due to an increase in the maximum combustion temperature. These problems are especially typical for low-emission gas turbine combustion chambers with preliminary mixing of fuel with an oxidizer, which requires a significant modification of the combustion chamber's burner devices. However, especially in the early stages of work related to the conversion of gas turbine engines from natural gas to hydrogen-containing fuels and pure hydrogen, it is necessary to assess the possibility of the reliable operation of basic fuel-burning devices when operating on mixtures of natural gas with hydrogen, to determine the ecological characteristics of serial combustion chambers and find operating modes, ensuring stable combustion of fuel without flashback phenomena into the pre-mixing devices.

The scope of this article is to investigate the energy and ecological characteristics of a low-emission gas turbine combustion chamber with pre-mixing of fuel with an oxidizer, which can be used in FPSO vessels and operates on mixtures of natural gas with hydrogen. This paper also aims to determine the operating modes of a 25 MW gas turbine serial combustion chamber without flashback into the channels of the radial-axial swirlers of the front device.

## OBJECT OF INVESTIGATION

The low-emission combustion chamber of a 25 MW gas turbine engine, manufactured by the 'Zorja-Mashpoekt' Gas Turbine Research & Production Complex, has a cannular counterflow structure with 16 flame tubes (Fig. 1), and implements the principle of dry combustion of a partially mixed lean mixture [15].

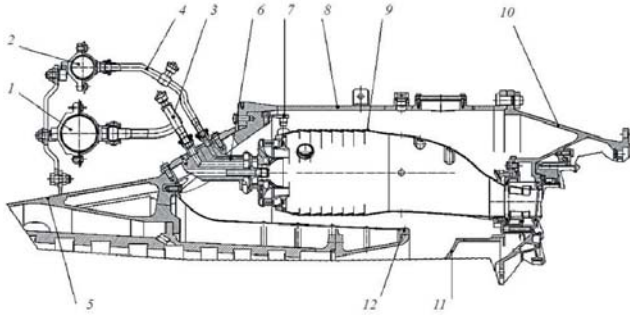

Fig. 1. Low-emission combustion chamber of a 25 MW gas turbine engine: 1, 2 – fuel collectors of the first and second channels; 3, 4 – fuel supply pipes; 5 – compressor casing; 6 – burner device; 7 – retainer; 8 – combustion chamber casing; 9 – flame tube; 10 – power casing; 11 – diffuser; 12 – inner casing

The main element of such a chamber is the burner device, consisting of two radial-axial swirlers of the first and second channels (the inner and outer swirlers, respectively), behind which are located annular mixing chambers. The portion of the air entering the inner swirler is approximately 12% of the total air flow through the flame tube, and the amount of air coming through the outer swirler is about 61% [15]. Fuel gas (natural gas) is supplied through a series of holes made in the blades of the radial-axial swirlers of the first and second channels. To sharply reduce the number of nitrogen oxides in a combustion chamber, partial preliminary mixing of fuel with air in the swirler channels is provided, and the resulting swirling fuel-air mixture is fed into the primary zone of the chamber. In the paraxial region of a combustion chamber, under the influence of swirling flows, a sufficiently extended recirculation zone is formed, which ensures reliable ignition of fresh portions of fuel and stabilisation of the lean mixture combustion.

The serial combustion chamber was designed for natural gas burning with low emissions of products of incomplete combustion and nitrogen oxides. It is supposed to be used for burning mixtures of natural (associated) gas with hydrogen as part of the project to create low-carbon energy systems.

## MATHEMATICAL MODELLING

The modelling of physical and chemical processes in a low-emission gas turbine combustion chamber is based on the solution of differential equations of mass, impulse, and energy conservation for the multi-component, turbulent, chemically reacting system.

A mass conservation equation or the continuity equation for compressible and incompressible media can be represented as follows [16]:

$$\frac{\partial \rho}{\partial t} + \nabla(\rho \vec{v}) = S_m, \quad (1)$$

where  $\rho$  is flow mass density,  $\vec{v}$  is a local flow velocity vector, and  $S_m$  is a source term which defines the mass supplied to the flow.

The momentum conservation equation in a fixed system of reference may be formed as follows [16, 17]:

$$\frac{\partial}{\partial t}(\rho \vec{v}) + \nabla(\rho \vec{v} \vec{v}) = -\nabla p + \nabla \cdot (\tau_{st}) + \rho \vec{g} + \vec{F}, \quad (2)$$

where  $p$  is the static pressure,  $\tau_{st}$  is the stress tensor, and  $\rho \vec{g}$  and  $\vec{F}$  are the gravitational body force and external body forces, respectively. In a generalised form, the energy conservation equation is written as follows:

$$\frac{\partial}{\partial t}(\rho E) + \nabla \cdot (\vec{v}(\rho E + p)) = \nabla \cdot (k_{eff} \nabla T - \sum_j \vec{J}_j + (\vec{\tau}_{eff} \cdot \vec{v})) + S_h, \quad (3)$$

where  $E$  is the total energy,  $k_{eff}$  is the effective conductivity,  $\vec{J}_j$  is the diffusion flux of species  $j$ , and  $\vec{\tau}_{eff}$  is the effective viscosity coefficient. The term  $S_h$  includes the heat of the chemical reaction.

If there is a need to consider the equations for chemical substances, then it is possible to obtain the concentration of each component  $Y_i$  by solving the equation for its convection-diffusion transfer. In general, this equation has the following form [18]:

$$\frac{\partial}{\partial t}(\rho Y_i) + \nabla(\rho \vec{v} Y_i) = -\nabla \cdot \vec{J}_i + R_i + S_i, \quad (4)$$

where  $R_i$  is the rate of forming the  $i$ -th component as the result of a chemical reaction,  $S_i$  is the level of additional forming of the  $i$ -th component from different sources, and  $\vec{J}_i$  is mass diffusion of the  $i$ -th component.

The net source of the  $i$ -th chemical component, which is obtained via the reaction, is calculated as the sum of the reaction sources over the  $N_R$  Arrhenius reactions in which the component takes part [19]:

$$R_i = M_{w,i} \sum_{r=1}^{N_R} R_{i,r}, \quad (5)$$

where  $M_{w,i}$  is the molecular weight of species  $i$  and  $R_{i,r}$  is the Arrhenius molar rate of formation/decomposition of the  $i$ -th component in the reaction  $r$ .

Let us consider the chemical reactions  $r$ , formed as follows:

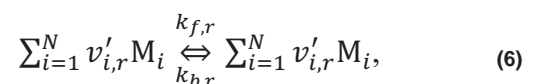

where  $N$  is the number of chemical species in the system;  $v'_{i,r}$  is the stoichiometric coefficient for the  $i$ -th reactant in the reaction  $r$ ,  $v''_{i,r}$  is the stoichiometric coefficient for the  $i$ -th product of the reaction  $r$ ,  $M_i$  is the symbol denoting the  $i$ -th chemical component,  $k_{f,r}$  is the forward rate constant for the reaction  $r$ , and  $k_{b,r}$  is the backward rate constant for the reaction  $r$ .

The molar rate of formation/decomposition of the  $i$ -th component in reaction  $r$  may be defined as follows [20]:

$$R_{i,r} = \Gamma(v''_{i,r} - v'_{i,r}) \cdot \left( k_{f,r} \prod_{j=1}^N [C_{j,r}]^{\eta'_{j,r}} - k_{b,r} \prod_{j=1}^N [C_{j,r}]^{\eta''_{j,r}} \right), \quad (7)$$

where  $C_{j,r}$  is the molar concentration of each  $j$ -th reagent and product in the reaction  $r$ ,  $\eta'_{j,r}$  is the rate exponent of the direct reaction for the  $j$ -th reagent and product in the reaction  $r$ ,  $\eta''_{j,r}$  is the rate exponent of the reverse reaction for the  $j$ -th reagent and product in the reaction  $r$ , and  $\Gamma$  represents the net effect of third bodies on the reaction rate and is defined as follows:

$$\Gamma = \sum_j \gamma_{j,r} C_j, \quad (8)$$

where  $\gamma_{j,r}$  is the third-body efficiency of the  $j$ -th component in the reaction  $r$ .

The forward rate constant for the reaction  $r$  is calculated using the Arrhenius expression:

$$k_{f,r} = A_r T^{\beta_r} e^{-E_r/RT}, \quad (9)$$

where  $A_r$  is a pre-exponential factor,  $\beta_r$  is the temperature exponent,  $E_r$  is the activation energy for the reaction, and  $R$  is the universal gas constant.

In this investigation, two combustion models were implemented in the Ansys Fluent software, which is supposed to be used to determine the energy and ecological characteristics of a low-emission gas turbine combustion chamber: 1) the Finite-Rate/Eddy-Dissipation (FR/ED) model, which computes the rates of chemical reactions using Arrhenius expressions and compares them to the overall rate of reaction controlled by turbulent mixing, and 2) the Eddy Dissipation Concept (EDC) model, in which detailed Arrhenius chemical kinetics can be incorporated in turbulent flames.

According to the FR/ED model, the reaction rate is calculated considering both the Arrhenius (7) and Magnussen and Hjertager turbulent mixing models [21]:

$$R_{i,r} = v'_{i,r} M_{w,i} A \rho \frac{\epsilon}{k} \min_R \frac{Y_R}{v'_{R,r} M_{w,R}}, \quad R_{i,r} = v''_{i,r} M_{w,i} A B \rho \frac{\epsilon}{k} \frac{\sum_P Y_P}{\sum_j v''_{j,r} M_{w,j}}, \quad (10)$$

where  $k$  is the turbulence kinetic energy,  $\epsilon$  is the dissipation rate of the turbulence kinetic energy,  $A$  and  $B$  are the empirical constants,  $Y_R$  is the mass fraction of a particular reactant  $R$ , and  $Y_P$  is the mass fraction of any product species  $P$ .

The reaction rate is taken to be the smaller of the expressions (7) and (10). This FR/ED chemistry-turbulence approach is used because there are regions within the combustion chamber where the turbulent mixing rate is faster than the chemical kinetics (low-temperature regions in the vicinity of the flame tube walls, air inlets, etc.).

To determine the values of  $k$  and  $\epsilon$ , the standard  $k$ - $\epsilon$  turbulence model [16] or its modification, the RNG-based  $k$ - $\epsilon$  -turbulence model [22], was used.

According to the EDC combustion model, the detailed Arrhenius chemical kinetics in flames is incorporated with turbulent fluctuations [23, 24]. The EDC model assumes that reaction occurs in small turbulent structures, called fine scales. Species react in fine structures over a timescale. Reactions proceed over the timescale, governed by Arrhenius rates, and are integrated numerically using a special algorithm. So, to calculate the net source of species  $i$  by the chemical reaction, it is necessary to find the volume fine-scale and time scale.

The molar velocity of formation/decomposition of the  $i$ -th component in the reaction is:

$$R_i = \frac{\rho(\xi^*)^2}{\tau^*[1-(\xi^*)^3]} (Y_i^* - Y_i), \quad (11)$$

where  $\xi^* = C_\xi \left( \frac{\nu \epsilon}{k^2} \right)^{\frac{1}{4}}$  is the size of a fine-scale reactor [23] which depends on the kinematic viscosity  $\nu$ , the turbulence kinetic energy  $k$  and the dissipation rate of the turbulence kinetic energy  $\epsilon$ ,  $C_\xi = 2.1377$  is the constant,  $\tau^* = C_\tau \left( \frac{\nu}{\epsilon} \right)^{\frac{1}{2}}$  is the time within which a reaction takes place,  $C_\tau = 0.4082$  is the constant, and  $Y_i^*$  is the fine-scale mass fraction after reacting over time  $\tau^*$ .

The proposed mechanism for the oxidation of a mixture of methane (replacing natural gas) with hydrogen, which makes it possible to predict the emission of carbon monoxide CO, is presented in Table 1.

The system of mass transfer equations (which includes convection, diffusion, formation, and decomposition of NO and related compounds) was used to simulate the nitrogen oxide emissions [25]:

$$\frac{\partial}{\partial t} (\rho Y_{NO}) + \nabla \cdot (\rho \vec{v} Y_{NO}) = \nabla \cdot (\rho D \nabla Y_{NO}) + S_{NO}, \quad (12)$$

where  $Y_{NO}$  is the NO mass concentration,  $D$  is the diffusion coefficient, and  $S_{NO}$  is the source term, depending on the  $NO_x$  formation mechanism.



Tab. 1. Mechanism of fuel oxidation

Reaction	A	E, J/kg mole	$\beta$	Reaction order			
				CH <sub>4</sub>	O <sub>2</sub>	CO	H <sub>2</sub> O
1 2 CH <sub>4</sub> + 3 O <sub>2</sub> → 2 CO + 4 H <sub>2</sub> O	4.64e+09	1.17e+08	-0.062	0.5	1.066		
2 2 CO + O <sub>2</sub> → 2 CO <sub>2</sub>	3.97e+11	7.68e+07	0.215	1.756	1.258		
3 2 CO <sub>2</sub> → 2 CO + O <sub>2</sub>	6.02e+05	1.31e+08	-0.108	1.357			
4 2 H <sub>2</sub> + O <sub>2</sub> → 2 H <sub>2</sub> O	9.87e+08	3.1e+07	0	1.0	1.0		

The boundary conditions in the inlets, symmetry axes, walls, and outlet from a combustion chamber were set following the operating mode's conditions and recommendations for modelling the turbulent burning processes. The method for the system solution, the finite difference scheme, and the solution stability analysis were explained in detail in [26].

To verify the proposed mathematical model and the kinetic mechanism of fuel oxidation, we calculated the formation of nitrogen oxides in a serial low-emission gas turbine combustion chamber (as shown in Fig. 1), operating on natural gas. The calculations were compared with the experimental data obtained on the single-burner section of a combustion chamber at a pressure of 0.15 MPa [15]. Bench tests were carried out to determine the temperature and environmental parameters of the flame tube of the low-emission combustion chamber. The experimental apparatus was equipped with the necessary heat engineering equipment; the Testo-350 gas analyser was used to determine the content of nitrogen oxide at the outlet of the single-burner compartment. The tests were carried out in seven operating modes, with different parameters of air and fuel at the inlet and the distribution of fuel consumption between the fuel channels of the swirler.

The comparison results for various operating modes, differing in the total fuel flow rate through the burner device  $G_p$ , are shown in Fig. 2. A satisfactory correlation is seen between the calculated and experimental data over a wide range of fuel flow rates. At a fuel flow rate of 20.9 kg/h, there is a fairly significant deviation of the calculated and experimental data. This is explained by the possibility of the occurrence of unstable modes of operation of the combustion chamber on lean mixtures, which was observed in a number of cases in the experiment. The instability leads to fluctuations in the temperature regime of the primary zone of the combustion chamber and an increase in emissions of nitrogen oxides.

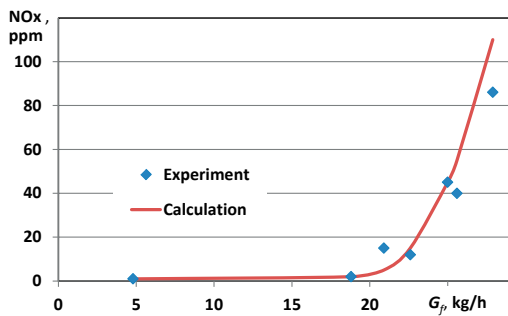

Fig. 2. Content of nitrogen oxides depending on natural gas flow rate

In addition, a comparison was made between the calculated and experimental values of the gas temperature in the outlet section of the flame tube (at 25 points and for seven operating modes), which showed the maximum error in determining the integral temperature at the outlet of a chamber of no more than 3%. These data indicate the possibility of using the above mathematical model to predict the characteristics of the combustion chamber of a gas turbine engine with partial preliminary mixing of gaseous fuel in the channels of radial-axial swirlers.

## RESULTS AND DISCUSSION

To calculate the characteristics of the working process in a low-emission gas turbine combustion chamber with the preliminary formation of a fuel-air mixture in the channels of the radial-axial swirlers of the flame tubes, the corresponding three-dimensional calculations were carried out using the Ansys Fluent software. The initial parameters of the working media were: air pressure at the combustion chamber inlet = 1.505 MPa, air flow rate through a combustion chamber = 52.96 kg/s, temperature = 759 K, gaseous fuel inlet temperature = 310 K, and flow rate when operating on natural gas = 3696.2 kg/h. With the addition of hydrogen, the flow rate changed, in proportion to the change in the lower calorific value of the mixture of natural gas and hydrogen.

Since the gas turbine combustion chamber consists of 16 flame tubes, the calculations were carried out for 1/16 of its total parts. Natural gas and a mixture of natural gas and hydrogen were supplied through two separate pipelines and two channels of the burner installed in the flame tube's front part (Fig. 3).

Furthermore, the fuel was fed through rows of small holes in the blades of the radial-axial swirlers (inner and outer) into the flow path of said swirlers, where it was mixed with air to form a homogeneous fuel-air mixture. This mixture was supplied to the primary zone of a combustion chamber, where it was reliably ignited due to the high temperature of the recirculating gases and completely burnt out before the dilution of the air supply cross-sections. A constant ratio of fuel flow rate through the inner and outer swirlers was maintained, equal to 0.242. This value was chosen to take into consideration the recommendations of the work by [15].

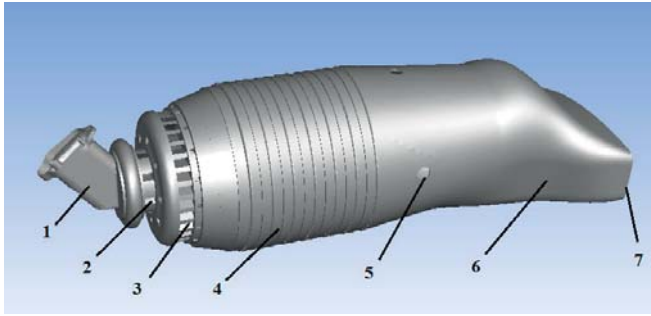

Fig. 3. Flame tube of a combustion chamber: 1 - burner; 2 - inner swirler; 3 - outer swirler; 4 - cooled shells; 5 - dilution air holes; 6 - flame tube diffuser; 7 - flame tube outlet

Figure 4 shows a graph of the effect of fuel mass flow rate through the inner  $G_{f1}$  and the outer  $G_{f2}$  radial-axial swirlers on the volume content of hydrogen in a mixture with natural gas, for one flame tube.

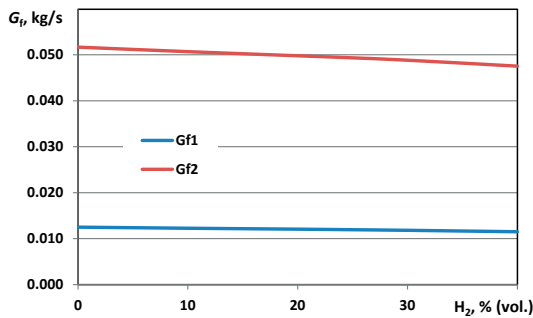
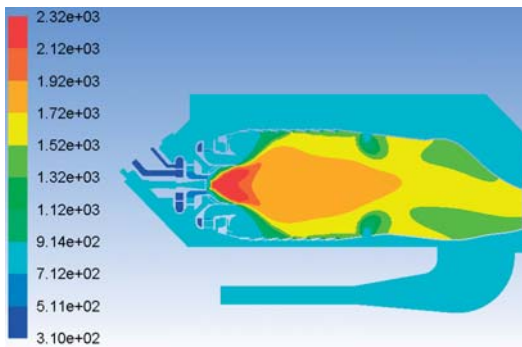
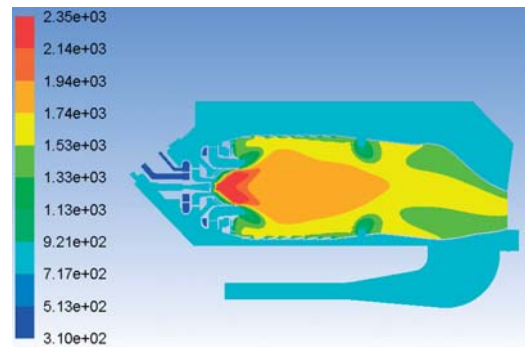

Fig. 4. Dependences of fuel mass flow rate through the inner and outer swirlers on the volume content of hydrogen in the mixture



(a)



(b)

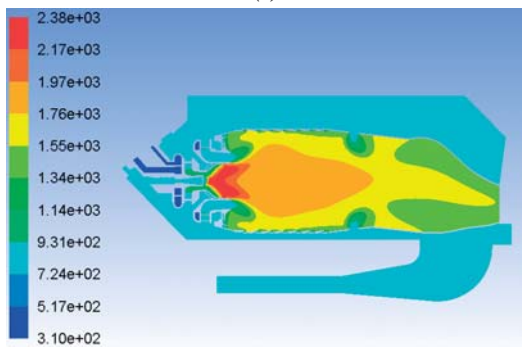

(c)

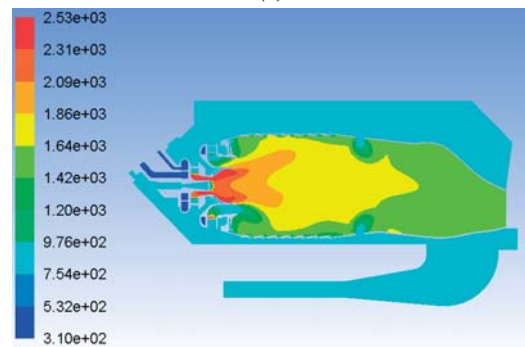

(d)

Fig. 6. Contours of temperature, K, inside a combustion chamber for different volume contents of hydrogen in the mixture: 0% (a), 20% (b), 30% (c), and 40% (d) for the EDC combustion model

It should be noted that the decrease in the total mixture flow rate was calculated as a proportion of the increase in the lower calorific value of the mixture with a growth in the amount of hydrogen in the fuel mixture. The average gas temperature at the combustion chamber outlet was about 1518 K (Fig. 5) and remained almost constant with a change in the amount of hydrogen in the gas mixture, as well as when using different combustion models (FR / ED or EDC).

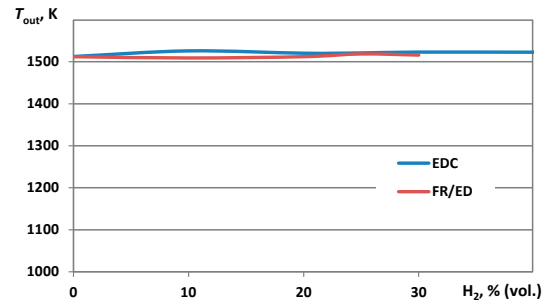

Fig. 5. Dependence of gas temperature at the outlet of a combustion chamber on the volume content of hydrogen in the mixture: EDC - Eddy Dissipation Concept, FR/ED - Finite-Rate/Eddy-Dissipation

To determine the influence of the EDC and FR/ED combustion models on the temperature distribution in the cross-sections of a low-emission combustion chamber, the corresponding calculations were carried out, the results of which are shown in Figs. 6 and 7, respectively.

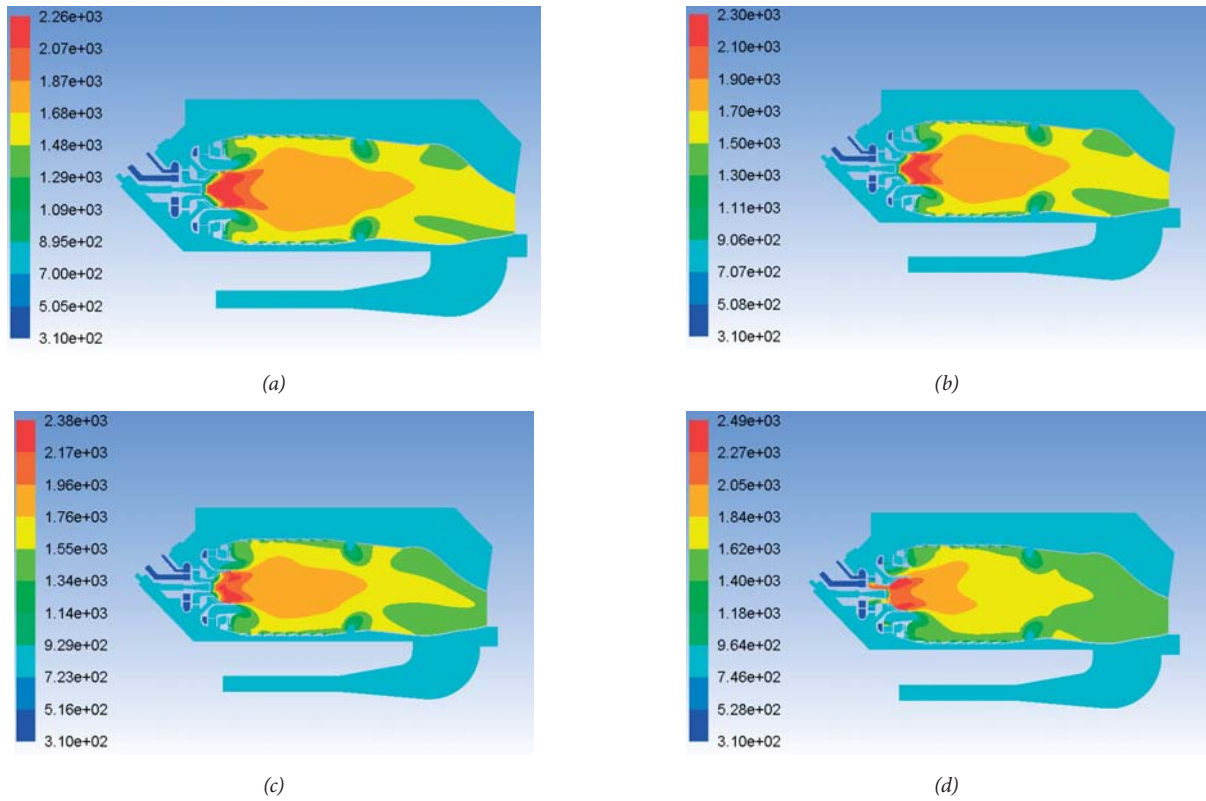

Fig. 7. Contours of temperature, K, inside a combustion chamber for different volume contents of hydrogen in the mixture: 0% (a), 10% (b), 20% (c), and 25% (d) for the FR/ED combustion model

It can be seen that when the EDC combustion model is used in the calculations, the initial combustion centres in the volume of the inner radial-axial swirler occur at a hydrogen content of 30% in the mixture. With 40% hydrogen, the flashback zone occupies the volumes of both swirlers with intense fuel burn-out in the cavity of the inner swirler.

When using the FR/ED combustion model in the calculations, chemical reactions in the inner swirler already take place at a hydrogen content of 25% in the mixture. It should be noted that these phenomena (flashbacks) are

unacceptable during the operation of a gas turbine engine because combustion within the burner channels leads to overheating of metal surfaces, melting, and warping, as well as mechanical damage to the turbomachine parts. These operating modes, of course, must be excluded from the turbine operation.

Significant changes in the heat release curve along the length of the flame tube in these cases, lead to a sharp change in the distribution of velocities over the sections of a combustion chamber (Figs. 8 and 9).

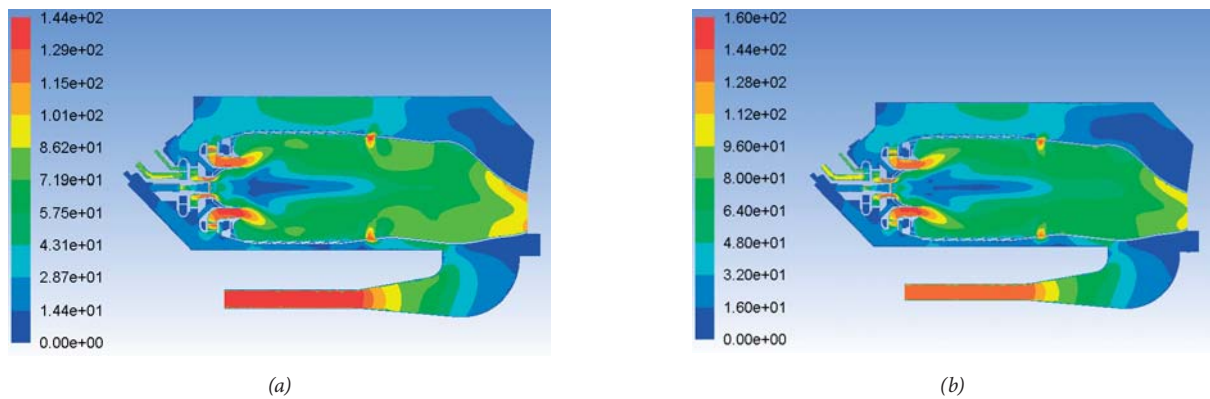

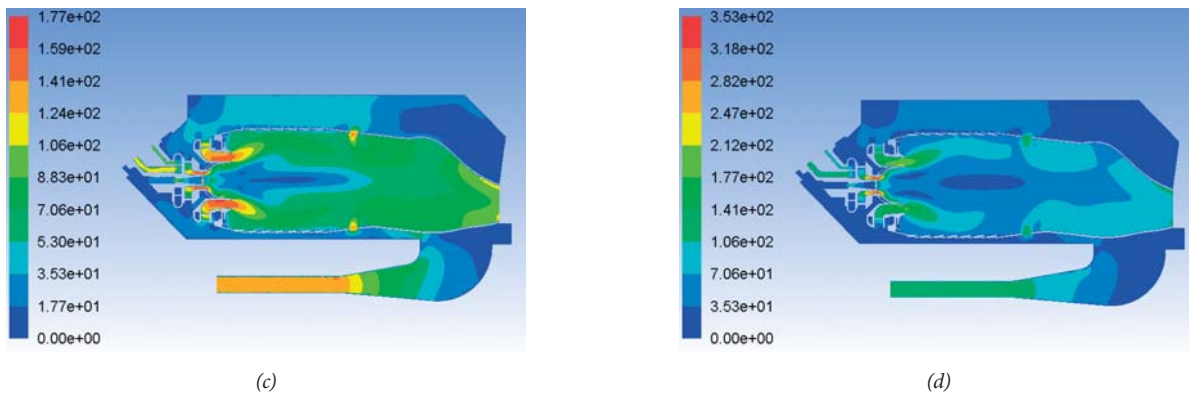

Fig. 8. Contours of velocity magnitude (m/s) inside a combustion chamber for different volume contents of hydrogen in the mixture: 0% (a), 20% (b), 30% (c), and 40% (d) for the EDC combustion model

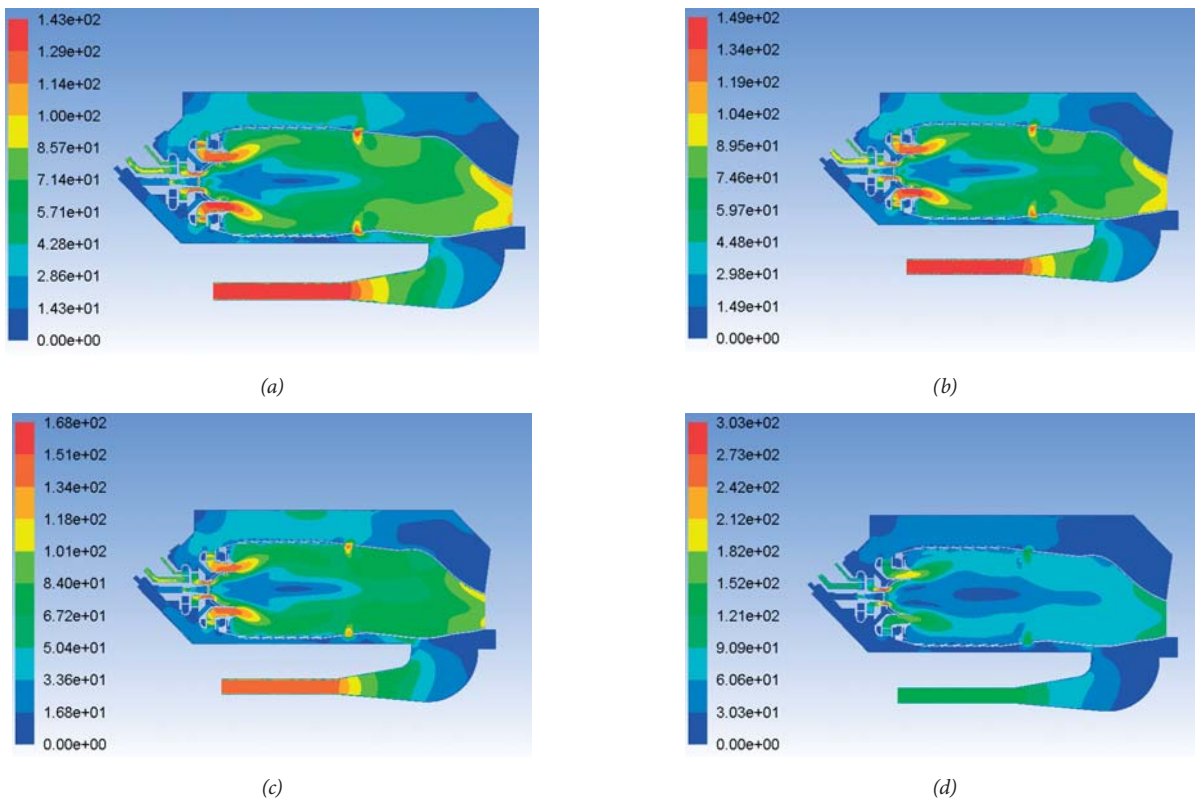

Fig. 9. Contours of velocity magnitude (m/s) inside a combustion chamber for different volume contents of hydrogen in the mixture: 0% (a), 10% (b), 20% (c), and 25% (d) for the FR/ED combustion model

If there is no flashback zone, then the maximum velocities in the characteristic sections of a combustion chamber do not exceed 170 m/s (Fig. 8a-b and Fig. 9a-c). When there is inflammation in the radial-axial swirlers of the burner device, the velocities of the working fluid in the narrowest sections of the swirlers increase sharply and reach maximum values of 300–350 m/s (Fig. 9d and Fig. 8d). This fact, along with an increase in the temperature level of the blade material, also leads to an increase in total pressure losses in a combustion chamber and an increase in the specific fuel consumption of the engine.

Figure 10 shows the distribution of mass fractions of nitrogen oxides NO in the sections of a combustion chamber for various hydrogen contents in the mixture and different

combustion models. It should be noted that the percentages of hydrogen (30% and 40% for the EDC model, and 20% and 25% for the FR/ED model) were chosen taking into consideration the transition from the mode without a flashback to the mode with a flashback in the burner's radial-axial swirlers. The presence of inflammation areas inside the swirlers leads to the initial formation of air nitrogen oxides, according to the Zeldovich thermal mechanism, directly inside the burner (Fig. 10b and Fig. 10d). In this case, as a result of an increase in the residence time of the working fluid in the high-temperature zone, the total length of the region where nitrogen oxides are formed also increases, which implies an increase in their content at the combustion chamber outlet.



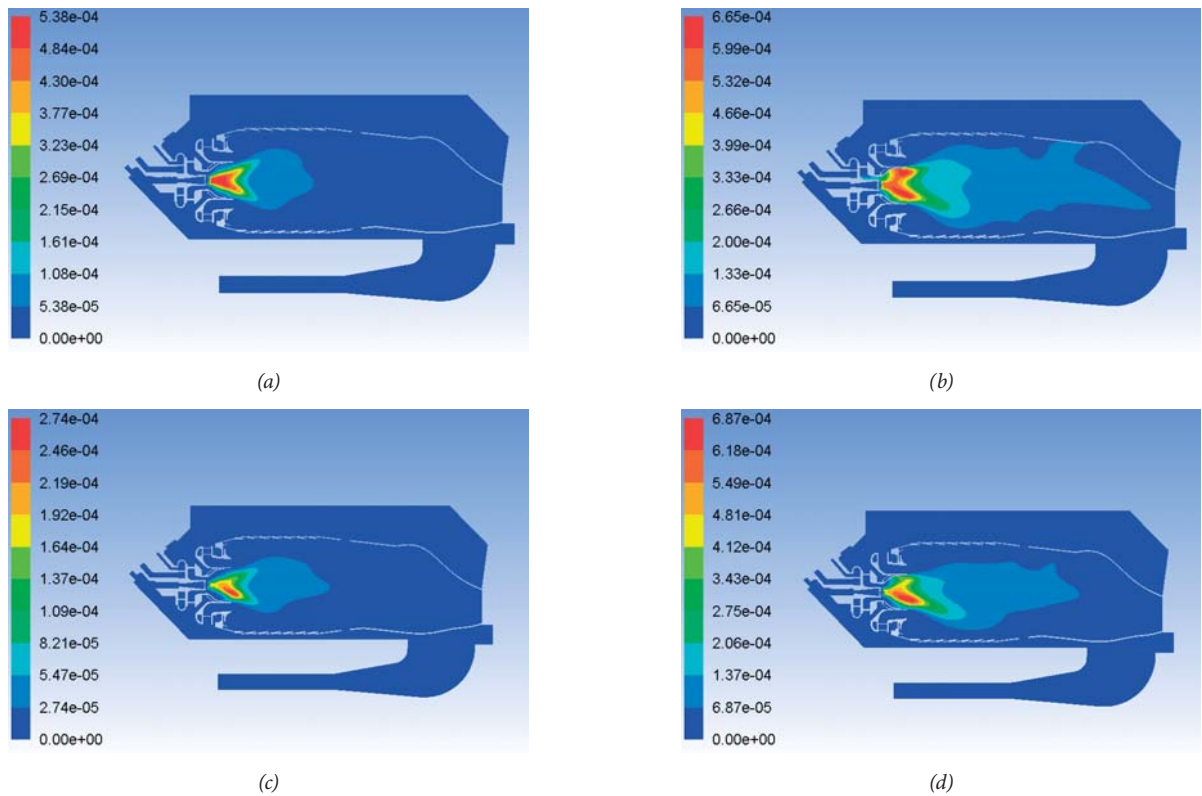
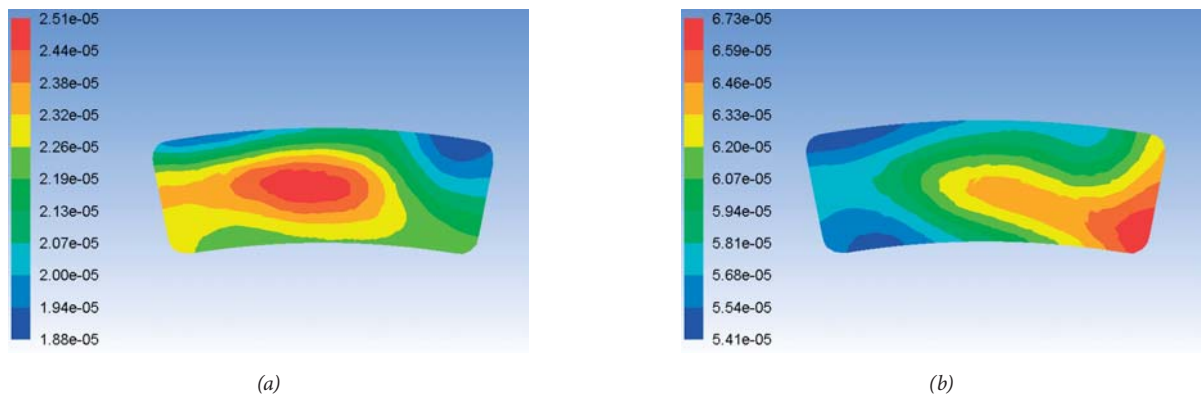

Fig. 10. Contours of NO mass fraction inside a combustion chamber for different volume contents of hydrogen in the mixture and different combustion models: 30%, EDC (a), 40%, EDC (b), 20%, FR/ED (c), and 25%, FR/ED (d)

Figure 11 shows the distribution of mass fractions of NO in the flame tube outlet section for various hydrogen contents in the mixture and different combustion models. We note a sharp increase in the maximum concentration of nitrogen oxides in the combustion chamber outlet section in the presence of a flashback zone due to the elongated total

length of the burning fuel. When inflammation zones appear inside the radial-axial swirlers (with just a slight increase in the hydrogen content in the mixture), the maximum mass fraction of nitrogen oxides in the outlet section increases by a factor of 2.7–4.2. This is observed at practically the same average temperature of the combustion products at the outlet.



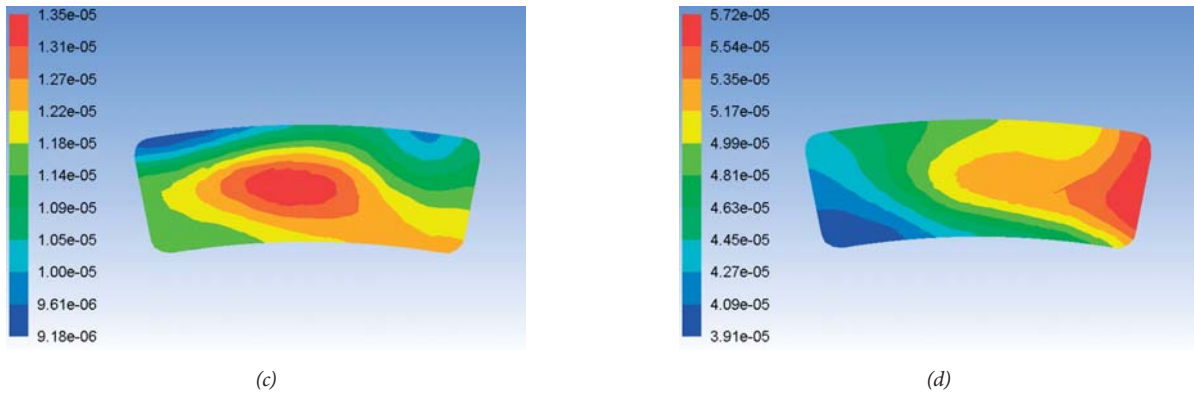

Fig. 11. Contours of NO mass fraction at the flame tube outlet for different volume contents of hydrogen in the mixture and different combustion models: 30%, EDC (a), 40%, EDC (b), 20%, FR/ED (c), and 25%, FR/ED (d)

An additional explanation for this phenomenon is shown in Fig. 12. This figure shows the distribution of gas temperature  $T$ , velocity magnitude  $v$ , mass fraction of carbon monoxide CO along the flame tube length  $l$  (for the FR/ED combustion model), and two values of the hydrogen content in the mixture: 20 and 25%. It can be seen that even a slight excess of the critical value of 20% of the hydrogen content in the mixture (for a given design of a combustion chamber)

leads to a sharp rise in temperature, flow rate, and CO content (red lines), in sections located at a distance of 0.05-0.06 m from the beginning of the front device. Furthermore, in the sections located behind the swirler's outlet, the processes of fuel burn-up level off and, at  $l \geq 0.1$  m, they change insignificantly with a change in the hydrogen content in the mixture.

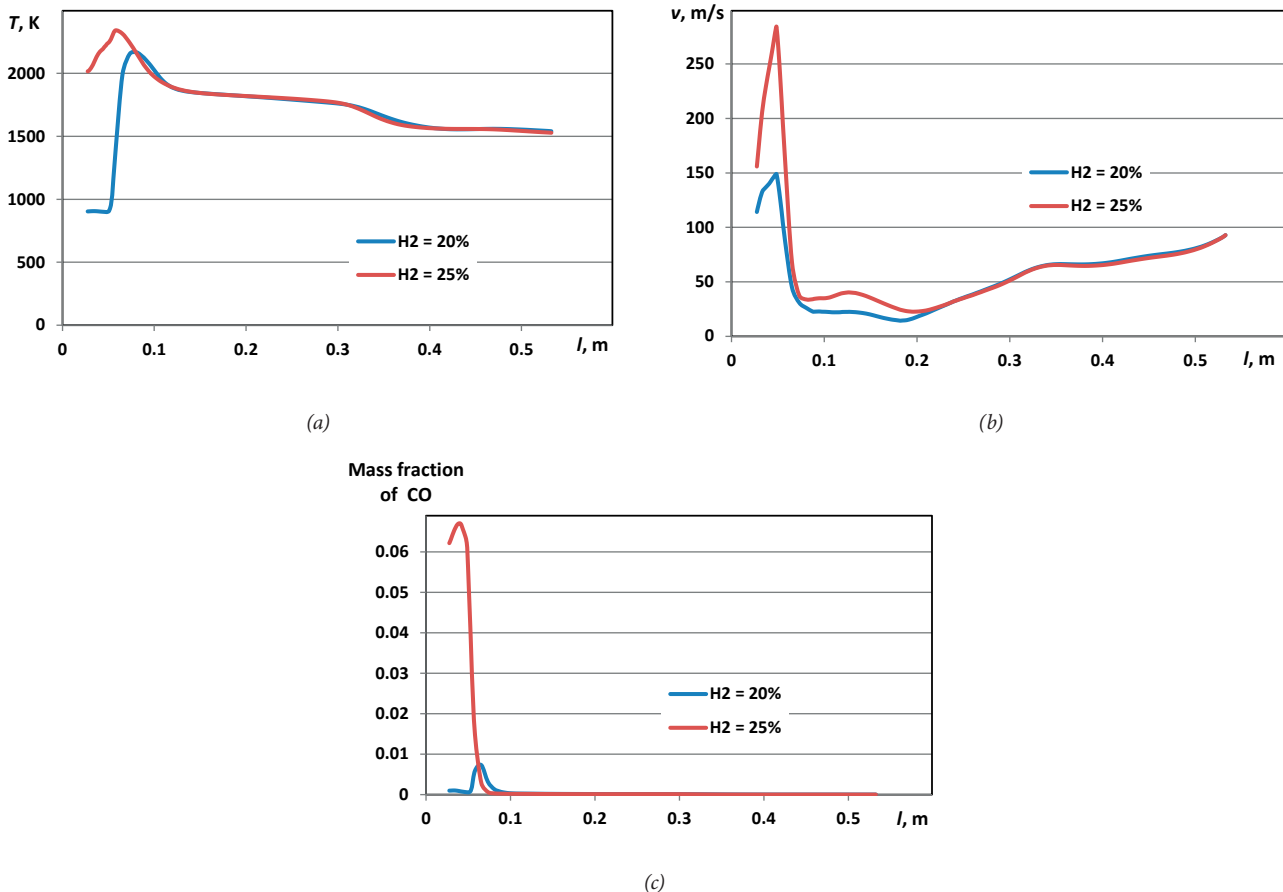
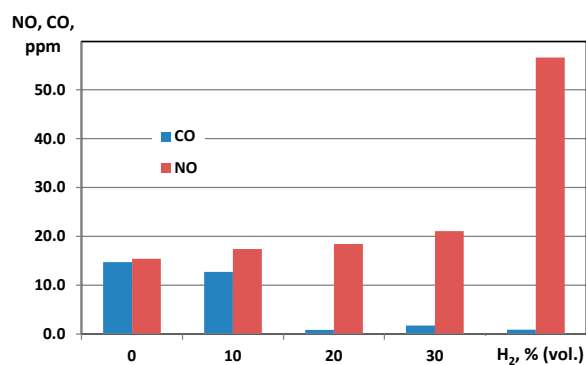

Fig. 12. Distribution of gas temperature (a), velocity magnitude (b), and mass fraction of CO (c) along the length of the flame tube for the FR/ED combustion model

Figure 13 shows the distributions of the average emissions of the main pollutants (CO and NO) at the combustion chamber outlet at various hydrogen contents in the mixture for different combustion models.

In all cases, an increase in the hydrogen content in the mixture leads to a decrease in emissions of carbon monoxide due to the intensification of combustion of the main fuel-air mixture and some increase in the maximum combustion temperature in the chamber volume (Fig. 6 and Fig. 7); this decrease is most significant when using the EDC combustion model.



(a)

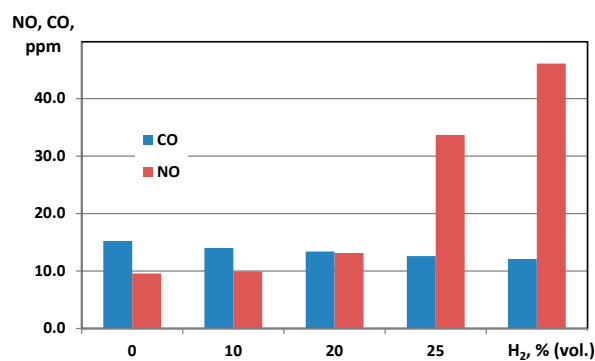

(b)

Fig. 13. Distribution of mole fractions of CO and NO at the flame tube outlet for different volume contents of hydrogen in the mixture and different combustion models: EDC (a), FR/ED (b)

For the investigated operation modes, in all cases, the calculated CO content does not exceed 16 ppm, which corresponds to the European requirements for emissions from gas turbine engines [27]. Without the presence of a flashback into the radial-axial swirlers, the calculated emissions of nitrogen oxide do not exceed 20 ppm, which also meets the requirements of [27]. When transferring to the flashback mode (when the hydrogen content in the mixture changes from 30% to 40% for the EDC combustion model and from 20% to 25% for the FR/ED combustion model), a sharp increase in nitrogen oxide emissions (up to 34-57 ppm) is observed. This is unacceptable, not only from the point of view of environmental requirements, but also from the conditions for ensuring the functionality of a combustion chamber itself.

It should be noted that the calculations performed showed that a combustion chamber with preliminary mixture formation in the channels of radial-axial swirlers is very sensitive to the hydrogen content in the mixture. The maximum predicted hydrogen content in the mixture, at which the formation of combustion centres in the swirler channels will not occur, does not exceed 25-30% by volume. This must be taken into consideration when modernising gas turbine engines with a combustion chamber of this type, when they are converted to a mixture of natural gas with hydrogen, hydrogen-containing gases, or pure hydrogen [28]. Further theoretical and experimental investigations are needed to expand the range of stable combustion without flashback, for fuel mixtures with a high hydrogen content, providing: a) optimisation of the geometry of radial-axial swirlers to increase the velocity of fuel-air mixture outflow

into the primary zone of the flame tube, b) redistribution of the amount of fuel gas supplied to the inner and outer swirlers, and c) studying the possibility of steam supplied to the burner.

## CONCLUSIONS

A mathematical model has been developed to determine the influence of hydrogen content and its mixture with natural gas on the characteristics of a low-emission gas turbine combustion chamber with preliminary mixing of fuel and with an oxidizer in the channels of radial-axial swirlers. A simplified kinetic scheme for the combustion of a mixture of natural gas and hydrogen is proposed, which makes it possible to predict the energy and ecological characteristics of a low-emission gas turbine combustion chamber, which can be used in FPSO vessels. When analysing processes in a combustion chamber, two models of gaseous fuel combustion were used: 1) the Finite-Rate/Eddy-Dissipation, which computes the rates of chemical reactions using Arrhenius expressions and compares them with the overall rate of reaction controlled by turbulent mixing, 2) the Eddy Dissipation Concept, in which detailed Arrhenius chemical kinetics can be incorporated in turbulent flames. The nature of a parameter's distribution over the sections of the combustion chamber, when using these two combustion models, is similar; however, the FR/ED model gives a narrower range of operation of a combustion chamber without the formation of a flashback zone into the radial-axial swirlers of the burner device.

It should be noted that, an increase in the hydrogen content in the mixture with natural gas for the investigated combustion chamber with premixing leads to a decrease in carbon monoxide emissions, due to improved combustion conditions of the fuel-air mixture in the combustion chamber's primary zone and some increase in the maximum

temperature of the working fluid in the chamber volume. For the investigated operation modes, the CO content at the combustion chamber outlet does not exceed 16 ppm, which corresponds to modern European requirements for emissions from gas turbine engines. The nitrogen oxide content at the combustion chamber outlet in operating modes, without the formation of a flashback zone, does not exceed 20 ppm and sharply increases to 34-57 ppm when combustion centres appear into the radial-axial swirlers of the flame tubes. Further investigations are required to expand the area of stable operation of a low-emission gas turbine combustion chamber of this type and to eliminate the flashback formation at increased hydrogen contents in the mixture with natural and associated gases.

## REFERENCES

- Hydrogen gas turbines. The path towards a zero-carbon gas turbine, ETN Global Report 2020. Available: <https://etn.global/wp-content/uploads/2020/02/ETN-Hydrogen-Gas-Turbines-report.pdf>, 2020.
- M. Nose, T. Kawakami, H. Araki, N. Senba, and S. Tanimura, "Hydrogen-fired Gas Turbine Targeting Realization of CO<sub>2</sub>-free Society. Mitsubishi Heavy Industries Technical Review," Available: <https://www.mhi.co.jp/technology/review/pdf/e554/e554180.pdf>, 2018.
- J. Beital, M. Talibi, S. Sadasivuni, and R. Balachandran, "Thermoacoustic Instability Considerations for High Hydrogen Combustion in Lean Premixed Gas Turbine Combustors: A Review," *Hydrogen*, vol. 2, pp. 33–57, 2021. DOI: <https://doi.org/10.3390/hydrogen2010003>.
- N. Tekin, M. Ashikaga, A. Horikawa, and H. Funke, "Enhancement of fuel flexibility of industrial gas turbines by development of innovative hydrogen combustion systems," *Gas for energy*, vol. 2, Available: [https://www.researchgate.net/publication/332290711\\_Enhancement\\_of\\_fuel\\_flexibility\\_of\\_industrial\\_gas\\_turbines\\_by\\_development\\_of\\_innovative\\_hydrogen\\_combustion\\_systems](https://www.researchgate.net/publication/332290711_Enhancement_of_fuel_flexibility_of_industrial_gas_turbines_by_development_of_innovative_hydrogen_combustion_systems), 2018.
- B.S. Soroka, K.E. Pyanykh, V.O. Zgursky, V.V. Gorupa, and V.S. Kudryavtsev, "Energy and environmental characteristics of household gas appliances using methane-hydrogen mixture as a fuel gas," *Oil and gas industry of Ukraine*, vol. 6, pp. 3-13, 2020 (In Ukrainian).
- R. Amaduzzi, M. Ferrarotti, and A. Parente, "Strategies for Hydrogen-Enriched Methane Flameless Combustion in a Quasi-Industrial Furnace," *Frontiers in Energy Research*, Available: <https://www.frontiersin.org/articles/10.3389/fenrg.2020.590300/full>, 2021. DOI: <https://doi.org/10.3389/fenrg.2020.590300>.
- A. Cappelletta, F. Martellia, E. Bianchib, and E. Trifonic, "Numerical redesign of 100kw MGT combustor for 100% H<sub>2</sub> fueling," *Energy Procedia*, vol. 45, pp. 1412-1421, 2014. DOI: <https://doi.org/10.1016/j.egypro.2014.01.148>.
- S. Barati1, L. De Santoli1, and G. Lo Bassol, "Modelling and Analysis of a Micro Gas Turbine Fuelled with Hydrogen and Natural Gas Blends," *E3S Web of Conferences*, vol. 312, 08012, pp. 1-13, 2021. DOI: <https://doi.org/10.1051/e3sconf/202131208012>.
- A.H. Ayed, K. Kusterer, H.H.W. Funke, J. Keinz, and D. Bohn, "CFD based exploration of the dry-low-NO<sub>x</sub> hydrogen micromix combustion technology at increased energy densities," *Propulsion and Power Research*, vol. 6(1), pp. 15-24, 2017. DOI: <https://doi.org/10.1016/j.jprr.2017.01.005>.
- A.H. Ayed, K. Kusterer, H.H.W. Funke, and J. Keinz, "CFD Based Improvement of the DLN Hydrogen Micromix Combustion Technology at Increased Energy Densities," *American Scientific Research Journal for Engineering, Technology, and Sciences (ASRJETS)*, vol. 26(3), pp. 290-303, 2016.
- V. Vilag, J. Vilag, R. Carlanescu, A. Mangra, and F. Florean, "CFD Application for Gas Turbine Combustion Simulations," Edited by G. Ji and J. Zhu, Available: <https://www.intechopen.com/chapters/69672>, 2019.
- S. Reza, M. Rahimi, A. Khoshhal, and A.A. Alsairafi, "CFD Study on Hydrogen-Air Premixed Combustion in a Micro Scale Chamber," *Iran. J. Chem. Chem. Eng.*, vol. 29(4), pp. 161-172, 2010. DOI: [10.30492/IJCCE.2010.6419](https://doi.org/10.30492/IJCCE.2010.6419).
- P. Gobatto, M. Masi, A. Toffolo, and A. Lazzaretto, "Numerical simulation of a hydrogen fuelled gas turbine combustor," *International Journal of Hydrogen Energy*, vol. 36, pp. 7993-8002, 2011. DOI: <https://doi.org/10.1016/j.ijhydene.2011.01.045>.
- M.E.H. Attia, A. Khechekhouche, and Z. Driss, "Numerical Simulation of Methane-Hydrogen Combustion in the Air: Influence on Combustion Parameters," *Indian Journal of Science and Technology*, vol. 11(2), pp. 1-8, 2018. DOI: [10.17485/ijst/2018/v11i2/120608](https://doi.org/10.17485/ijst/2018/v11i2/120608).
- S.I. Serbin, A.V. Kozlovskiy, and K.S. Burunsuz, "Investigations of non-stationary processes in low emissive gas turbine combustor with plasma assistance," *IEEE Trans. Plasma Sci.*, vol 44(12), pp. 2960-2964, 2016. DOI: [10.1109/TPS.2016.2607461](https://doi.org/10.1109/TPS.2016.2607461).
- B.E. Launder, and D.B. Spalding, "Lectures in Mathematical Models of Turbulence," London: Academic Press, 1972.



17. I.B. Matveev, S.I. Serbin, V.V. Vilkul, and N.A. Goncharova, "Synthesis Gas Afterburner Based on an Injector Type Plasma-Assisted Combustion System," *IEEE Trans. Plasma Sci.*, vol. 43(12), pp. 3974-3978, 2015. DOI: 10.1109/TPS.2015.2475125.
18. I.B. Matveev, and S.I. Serbin, "Theoretical and experimental investigations of the plasma-assisted combustion and reformation system," *IEEE Trans. Plasma Sci.*, vol. 38(12), pp. 3306-3312, 2010. DOI: 10.1109/TPS.2010.2063713.
19. I.B. Matveev, S.I. Serbin, and N.V. Washchilenko, "Plasma-assisted treatment of sewage sludge," *IEEE Trans. Plasma Sci.*, vol. 44 (12), pp. 3023-3027, 2016. DOI: 10.1109/TPS.2016.2604849.
20. I. Matveev, S. Serbin, and S.M. Lux, "Efficiency of a hybrid-type plasma-assisted fuel reformation system," *IEEE Trans. Plasma Sci.*, vol. 36(6), pp. 2940-2946, 2008. DOI: 10.1109/TPS.2008.2006843.
21. B.F. Magnussen, and B.H. Hjertager, "On mathematical models of turbulent combustion with special emphasis on soot formation and combustion," 16th Symp. (Int.) on Combustion. The Combustion Institute, vol. 16(1), pp. 719-729, 1977.
22. V. Yakhot, and S.A. Orszag, "Renormalization Group Analysis of Turbulence: I. Basic Theory." *Journal of Scientific Computing*, vol. 1(1), pp. 1-51, 1986.
23. B.F. Magnussen, "On the Structure of Turbulence and a Generalized Eddy Dissipation Concept for Chemical Reaction in Turbulent Flow," *American Institute of Aeronautics and Astronautics, Aerospace Sciences Meeting*, 19th, St. Louis, pp. 1-7, 1981.
24. I.R. Gran, and B.F. Magnussen, "A numerical study of a bluff-body stabilised diffusion flame. Part 2. Influence of combustion modelling and finite-rate chemistry," *Combustion Science and Technology*, vol. 119 (1-6), pp. 191-217, 1996. DOI: <https://doi.org/10.1080/00102209608951999>.
25. R. Meloni, "Pollutant Emission Validation of a Heavy-Duty Gas Turbine Burner by CFD Modelling," *Machines*, vol. 2, pp. 81-97, 2013. DOI: <https://doi.org/10.3390/machines1030081>.
26. "ANSYS Fluent Theory Guide," ANSYS, Inc., pp. 1-780, 2013.
27. Directive 2010/75/EU of the European Parliament and of the Council of 24 November 2010 on industrial emissions (integrated pollution prevention and control), Available: <https://eur-lex.europa.eu/legal-content/EN/TXT/?uri=celex:32010L0075>, 2010.
28. O. Cherednichenko, S. Serbin, and M. Dzida, "Application of thermo-chemical technologies for conversion of associated gas in diesel-gas turbine installations for oil and gas floating units," *Polish Maritime Research*, vol. 3(103), pp. 181-187, 2019. DOI: <https://doi.org/10.2478/pomr-2019-0059>.

## CONTACT WITH THE AUTHORS

### Serhiy Serbin

*e-mail: serbin1958@gmail.com*

Admiral Makarov National University of Shipbuilding,  
Geroes of Ukraine, 54025 Mikolayiv,  
**UKRAINE**

### Kateryna Burunsuz

*e-mail: kateryna.burunsuz@nuos.edu.ua*

Admiral Makarov National University of Shipbuilding,  
Heroes of Ukraine Ave. 9, 54025 Mikolayiv,  
**UKRAINE**

### Daifen Chen

*e-mail: dfchen@just.edu.cn*

Jiangsu University of Science and Technology,  
2 Megnxi Road, 212003 Zhenjiang,  
**CHINA**

### Jerzy Kowalski

*e-mail: jerzy.kowalski@pg.edu.pl*

Gdansk University of Technology,  
11/12 Gabriela Narutowicza Street, 80-233 Gdansk,  
**POLAND**