

IAC-22-A1,3

INVESTIGATION OF THE EFFECT OF THE ROCKET'S SUBORBITAL FLIGHT ON BIOFILM, ENZYMES AND BIOSYNTHESIS ON AUTONOMOUS, MODULAR AND SCALABLE PLATFORM FOR CONDUCTING EXPERIMENTS OF AN ASTROBIOTECHNOLOGICAL NATURE

Bartosz Rybacki^{*}1, Wojciech Wysocki¹, Marcin Jasiukowicz¹, Bartosz Rybak², Julian Lützen¹, Natalia Czortek¹, Kacper Lorek¹, Szymon Krawczuk¹, Norbert Szulc¹, Tomasz Zajkowski³, Alec Vallota-Eastman⁴, Julia Godlewska¹, Beata Krawczyk¹,

¹Gdańsk University of Technology, *bartoszyrybackiscience@gmail.com, kontakt@simle.pl;

²Medical University of Gdańsk; ³Blue Marble Space Institute of Science, Polish Astrobiological Society;

⁴University of California, Santa Barbara

Abstract

With new incentives for human space exploration, biotechnological experiments in orbit became imperative. Answering this need, we build an autonomous, modular, and scalable platform that enables those experiments on rockets. We called it AMBER. The aim of the payload of the R6 suborbital rocket is to perform an experiment to study the influence of rocket flights on biofilm, molecular biology enzymes and biosynthesis using our platform. For this purpose, we use the interdisciplinary character of our team to ensure full integrity, reliability, and operational efficiency. The experiment carried out during the Spaceport America Cup competition constitutes the first stage of our team's three-stage programme of astrobiotechnological experiments, which scientific value was confirmed by a letter of recommendation from the scientist working for NASA Ames Research Center. Two 96 well plates, as operational sectors, were subjected to the same effects of G-force, rocket launch velocity, temperature, pressure and vibration profile. In the experiment we used 3D printed elements, Peltier cells, GPS, sensors measuring vibrations, temperature, pressure and G-force. These instruments enable exact characterisation conditions experienced by biological samples.

Keywords: astrobiotechnology, biofilm, enzymes, biopharmaceutics, 3D-printing, rocket

Acronyms/Abbreviations

Autonomous Modular Biotechnological Experiment on a Rocket (AMBER), International Space Station (ISS), National Aeronautics and Space Administration (NASA), Global Positioning System (GPS), Inertial Measurement Unit (IMU), Polyethylene Terephthalate Glycol (PET-G), Thermoplastic Polyurethane (TPU), Direct Current (DC), Deutsches Institut für Normung (DIN), Optical Density (OD), Gdańsk University of Technology (GUT, Gdańsk Tech)

1. Introduction

As the space industry grows, the ability to bring more humans to space becomes more available. With the higher number of crewed space missions grows the concern on the health of spacefarers. To understand the effects of the space environment on humans and biotechnological payload, new scientific platforms are needed. To answer this need, we build an autonomous, modular, and scalable platform that enables biological experiments on rockets (AMBER). AMBER will help build new standards for payload for rockets.

Controlling basic physical parameters around samples was the priority as well as measuring the external experience by payload. Our system will make replicability of experiments easier and better supervised.

The first round of tests on AMBER was carried out during Spaceport America Cup competition in New Mexico (USA), flight was delayed and finally launched in Gdynia (Poland).

2. Components & Materials Used to build AMBER

AMBER meets the competition's and team's internal requirements when it comes to dimensions (30x10x10 cm) and a weight (4 kg) [1]. Payload is a solid structure consisting of a frame and sidewalls, in the centre of which is located our scientific panel [2].

The main frame is made of standardised 10x10mm v-slots profiles. Connecting blocks, Allen screws M3 DIN7991 and T-nuts are used for the assembly.

The payload structure is modular. PET-G 3D printed shelves are used with a standardised assembly method to secure the modules inside the payload. TPU 3D printing was used to make the well plate sealing frame to ensure its tightness. The sealing frame consists (fig. 1) of a top (1) and bottom box (7), a copper plate (2), a clamping aid (4) [3,4], a sealing film (5), well-plate cover (3) and a well-plate base (6). Steel plates have been used as walls to provide adequate mechanical protection and reliable vibration transmission.

Such a solution allows to use the design and research results in future in different conditions.

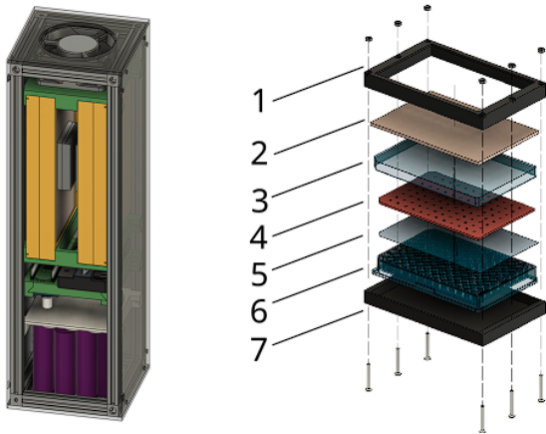

Fig. 1 - CAD model of an assembled payload; exploded view of a well-plate's sealing frame.

The well plate holder is made of copper to evenly distribute heat from the well plate to the Peltier module and then through the heat sink to the outside of the experiment chamber. To ensure efficient cooling, a 12V DC axial fan is used with an airflow of 67m³/h [5]. Openings in the top and side covers allow free air flow between the payload and atmosphere.

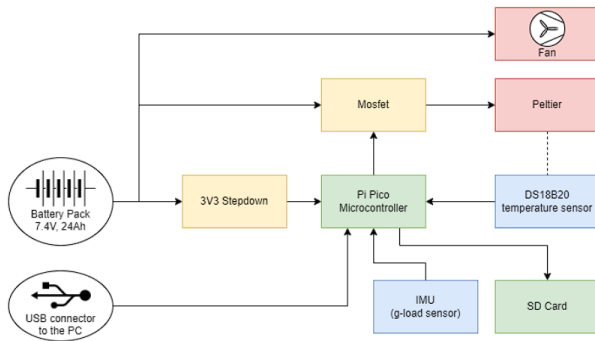

Fig. 2 - Block diagram of the Electronics Subsystem.

Mission specific electronic control system has been designed to monitor and control the internal temperature of the samples. Peltier cells are used to move heat out of the copper plates into surrounding air via radiator. Motion and the acceleration (G-Loads) of the experiment has been recorded using an Inertial Measurement Unit (IMU). The power to the experiment is supplied by twelve 21700 cells, providing 24Ah of power at 7.4V.

Table 1: List of materials:

Name	Quantity, description
V-slot MakerBeam profiles	10x10 mm (approx. 0.39x0.39 in)
Connecting blocks for MakerBeam profiles	8x blocks
Allen screws	M3 DIN7991 (M3x6, M3x8, M3x25)
T-nuts	For MakerBeam 10x10 mm (approx. 0.39x0.39 in) profiles
Copper plates	Cut to wellplate frame size (2 plates)
Steel plates	Cut to 3U enclosure size
Fan	60x60x25 mm (approx. 2.36x2.36x0.98 in)
DevilDesign PET-G filament for 3D printer	Diameter: 1.75 mm (approx. 0.07 in)
Fiberlogy Fiberflex 40D filament for 3D printer	Diameter: 1.75 mm (approx. 0.07 in)

3. Scientific purposes

The overall goal of our AMBER project was to create a versatile rocket payload to easy biotechnological experiments. To prove functionality of AMBER we have loaded biological samples for the duration of R6 rocket launch.

The experiment carried out focused on bacterial biofilm production and its durability.

Testing biofilms in space is substantial [7], [10]. A biofilm is a form of a bacterial group that contains in its surroundings, organic or inorganic substances produced by bacteria, whose structure adheres to a given surface [6], [7], [8].



Fig. 3 - An example of biofilm formation located at the inlet to Russian condensate processor. Photo: NASA [9]

This surface can be a part of a spaceship or a human body including a respiratory system. Bio biofouling is a realistic safety threat on International Space Station (ISS). As pathogenic bacteria also form biofilms this kind of research contributes also directly to astronauts' health.

More basic research on biofilm is also needed as it may also be important for creation of microbiome on Mars or its future colonisation (biofilm is formed under the influence of degrading environmental factors / life-limiting factors [7]).

In the biofilm experiment on board of AMBER the aim was to test what is the impact of the suborbital flight of the rocket and the accompanying g-loads (acceleration / G), vibration, pressure, and temperature profiles on the ability of selected bacterial strains to produce biofilm. We examine the structure and durability of the biofilm by counting the number of detached cells in the solution in a given well.

Samples will be subjected to DNA sequencing to assess the impact conditions occurring during the flight on formation of mutations. The reference tests will be performed in an ultracentrifuge and possibly on a stratospheric balloon nacelle.

3.1 The method of producing biofilm along with the method of its analysis

This step is the most important part of the biological experiment. Below we described the process of preparing the biofilm that was to be subjected to the flight conditions and afterward tested with methods listed in the next point [13,14].

Experimental procedures (biofilm formation):

(1) bacteria were added to the broth. Calibrated to 0.5 on the McFarland scale in LB medium with 0,25% glukoze. The biofilm formation assay was performed as in Nykyri et al. (2013), with some modifications. 200 μ l of prepared bacterial culture was inoculated into 96-well Nunclon Delta Surface (Greiner) plates and (2) kept for 24h at 37°C without agitation. (3) After the incubation period, OD600 of bacterial cultures was measured and the bacterial cultures were removed from the wells. Then, 200 μ l of 1% crystal violet solution was added into each well and left for 15 min without agitation. After incubation, the wells were washed 2 times with distilled water. Then, 200 μ l of acetic acid solution (33% Sigma Aldrich, Germany) was added into each well and (4) OD595 of each well was measured. For calculations, the OD595 value of the negative control was subtracted from the values obtained for the strains. Negative values obtained after subtraction were set to 0. The experiment was performed once with three replicates. (5)

3.2 Experimental procedure

Following the suborbital flight, we operated the probes using the previously described methods. Precise protocols that depend on specific strains of microorganisms are described in detail in a separate scientific payload documentation.



Fig. 4 - Prepared well plate with a McFarland calibrated bacterial suspension prior to rocket launch.

To examine the optical density of suspension of the microorganisms we used spectrophotometry techniques. In the analysis used Epoch BioTek UV-Vis spectrophotometer.

To check the durability of the formed biofilm we provided 3 independent research methods. The first method is spectrophotometric and is based on the previously described procedure for staining cells with crystal violet. In this way, we obtained comparative values for the amount of biofilm that remained on the walls of the wells. The second method measures the opposite values by counting the cells that detached from the solid form of the biofilm and ended up in the external matrix. For this purpose, we used Thoma chambers and an optical microscope. Using the counting chamber we were able to assess the exact number of the cells. The third technique we used is serial dilution method.

3.3 Selected strains

As mentioned above, we focus on the strains of microorganisms that are tightly correlated to humans' existence in space. We selected strains of opportunistic human pathogens, as well as model organisms of bacteria. Additionally, we used species of microorganisms that were previously collected in the stratosphere during BEXUS 30 stratospheric mission and established as pure cultures [15].

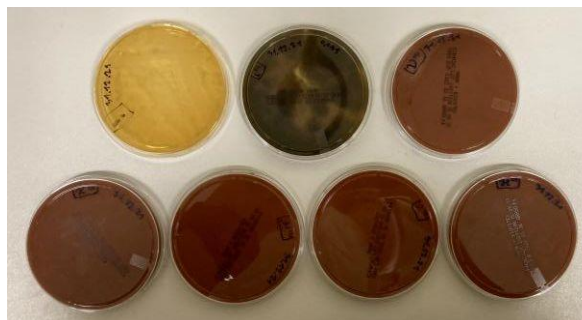

Fig. 5 - Plates with some microorganisms obtained from the stratosphere as part of the Stardust project, organised in cooperation with the European Space Agency [15].

4. Results

4.1 Payload performance

Integrity AMBER was kept. All flight data of parameters was successfully measured and recorded. The integrity of the cassettes ensuring their mechanical safety has been intact. Biological samples survived the flight.

Condition	Minimum	Maximum
Pressure [hPa]	859,25	1015,57
Temperature [°C]	6,70	11,90
Acceleration [g]	0,03	13,97
	Maximum	
Velocity [m/s]	193,70	
Altitude [m]	1572,00	

Fig. 6 - Extremes of the conditions acting on the rocket during flight.

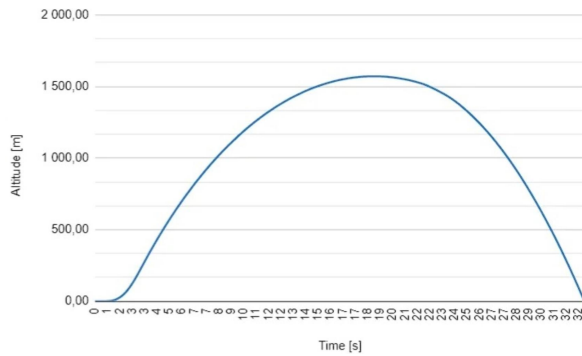

Fig. 7 - Altitude in time during rocket's flight.

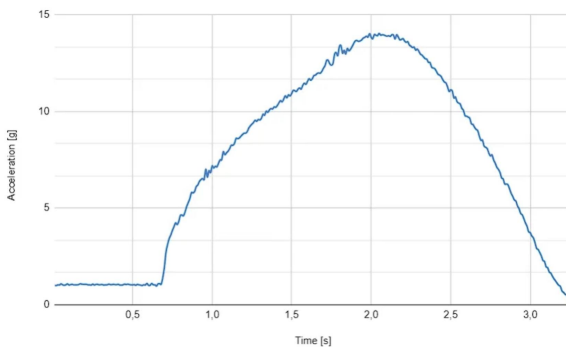

Fig. 8 - Acceleration in time during first seconds of a rocket's flight.

4.2 Biotechnological experiments

The study shows that the flight of the suborbital rocket significantly affects the ability of selected bacterial strains to produce biofilm as well as the durability of it.

Bacteria exposed to G force, pressure and velocity of the rocket, which were full of changing parameters, limited the amount of biofilm.

For each strain, 3 measurements were made in three different wells. Within the various bacterial strains, the results were very closely related. In the results obtained from the first research method, there is a tendency for higher absorption values for bacterial strains from ground control than for those from rocket flight.

Comparison of the ability to produce biofilm by microorganisms from "ground control" and "rocket flight"

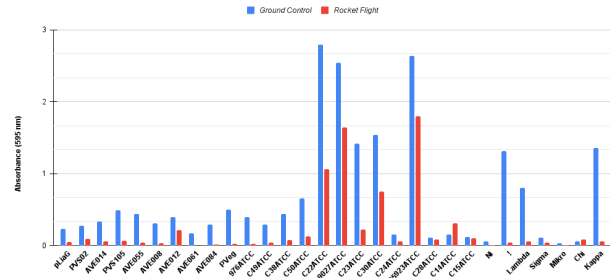

Fig. 9 - Chart summarizing the influence of suborbital rocket flight on microorganisms ability to produce biofilm.

When it comes to an experiment which was subjected to determine the durability of a biofilm it also has logical numerical values. It shows that a different number of cells broke away from the solid form of biofilm, therefore different strains are characterized by different biofilm resilience. The lower the absorbance value, the fewer cells found their way to the external matrix and the more durable is the biofilm.

Comparison of the durability of the biofilm produced by microorganisms from ground control and rocket flight

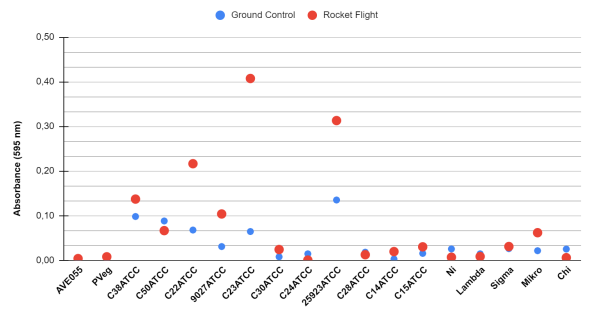

Fig. 10 - Chart summarizing the influence of suborbital rocket flight on durability of biofilm produced by selected strains of microorganisms.

The developed method of ensuring the tightness and separation of 96 wells showed 98.96% efficiency.

5. Discussion

The platform we created shows that we are able to carry out research correlated with the space sector in a more universal, accessible and faster way. That is why AMBER has a major advantage over other platforms where only remote measurements are possible. By minimizing the scale of the flight from orbital to suborbital, we can perform astrobiotechnological research much more frequently and repeatedly.

Further discussion of the research performed will be explained in a separate scientific publication.

6. Conclusions

AMBER as a platform performed its task perfectly giving the opportunity to conduct scientific research and fulfill its purpose.

The results of the research indicate how to select bacterial strains to control their activity in the form of biofilm structuring. Bacteria being exposed to the influence of suborbital flight show different ability to produce biofilm and its different durability. These conclusions can provide important information to be able to perform scientific research in space using it as genetic engineering vectors, protect the ISS from polymer and metal damage, treat astronauts more efficiently or colonize Mars.

Acknowledgements

Research on this project has been part of efforts by SimLE Science Club, Gdańsk University of Technology (Gdańsk Tech). The funding for the experiment has been provided by the Student Council of Gdańsk Tech as well as the Dean of Mechanical Engineering and Oceanography Department.

Special thanks for providing bacterial strains, showing help and substantive support:

Bacteria provided by Bartosz Rybak, MD (Division of Environmental Toxicology, Faculty of Health Sciences with the Institute of Maritime and Tropical Medicine, Medical University of Gdańsk), Beata Krawczyk, PhD (Department of Biotechnology and Microbiology, Faculty of Chemistry, Gdańsk University of Technology), Tomasz Zajkowski, PhD (Blue Marble Space Institute of Science, BMSIS, Polish Astrobiological Society) and Alec Vallota-Eastman, PhD (University of Santa Barbara).

List of references

Number the references (numbers in square brackets) in the list in the order in which they appear in the text.

Examples:

Reference to a website:

[1] Spaceport America Cup- Intercollegiate Rocket Engineering Competition Rules & Requirements Document,

[1]https://www.soundingrocket.org/uploads/9/0/6/4/9064598/sa_cup_irec_rules__requirements_document_20210927_rev_j.pdf (accessed 03.09.2022)

[2]https://solc.gsfc.nasa.gov/modules/launch/mainMenu_textOnly.php#:~:text=A%20payload%20means%20a%20valuable,contained%20within%20the%20launch%20vehicle (accessed 15.09.2022)

[3]https://fiberlogy.com/wp-content/uploads/2021/12/FIBERLOGY_FIBERFLEX_30D_TDS.pdf (accessed 15.09.2022)

[4]https://fiberlogy.com/wp-content/uploads/2022/01/FIBERLOGY_FIBERFLEX_30D_MSDS.pdf (accessed 15.09.2022)

[5]<https://pl.rs-online.com/mobile/p/wentylatory-osiowe/7878936/> (accessed 15.09.2022)

Reference to a journal publication:

[6] S. Arnaouteli, C. E. Mac Phee, N. R. Stanley-Wall, Just in case it rains: building a hydrophobic biofilm the *Bacillus subtilis* way, Current Opinion in Microbiology, Volume 34, December 2016, Pages 7-12, DOI:10.1016/j.mib.2016.07.012

[7] L. Zea, R. J.C.McLean, T. A.Rook, G. Angle, D. Layne Carter, A. Delegard, A. Denvir, R. Gerlach, S. Gorti, D. McIlwaine, M. Nur, B. M.Peyton, P. S.Stewart, P. Sturman, Y. A. V. Justiniano, Potential biofilm control strategies for extended spaceflight missions, Biofilm, Volume 2, December 2020, 100026 DOI:10.1016/j.biofilm.2020.100026

[8] K. Czaczyk, K. Wojciechowska Tworzenie biofilmów bakteryjnych istota zjawiska i mechanizmy oddziaływań, BIOTECHNOLOGIA 3 (62) 180-192 2003, https://rcin.org.pl/Content/133292/POZN271_167975_b_iotechnologia-2003-no3-czaczyk.pdf (in Polish)

[9] L. Zea, Z. Nisar, P. Rubin, M. Cortesão, J. Luo, S. A.McBride, R. Moeller, D. Klaus, D. Müller, K. K.Varanasi, F. Muecklich, L. Stodieck, Design of a spaceflight biofilm experiment, Acta Astronautica, Volume 148, July 2018, Pages 294-300, DOI:10.1016/j.actaastro.2018.04.039

[10] W. Kim, F. K. Tengra, Z. Young, J. Shong, N. Marchand, H. K. Chan, R. C. Pangule, M. Parra, J. S. Dordick, Joel L. Plawsky, C. H. Collins,
Spaceflight Promotes Biofilm Formation by *Pseudomonas aeruginosa*,
Plos One, Published: April 29, 2013,
DOI:10.1371/journal.pone.0062437

[11] L. Zhon, Y. Song, S. Zhou,
The Effectiveness of Nafion-Coated Stainless Steel Surfaces for Inhibiting *Bacillus Subtilis* Biofilm Formation,
MDPI Applied science, 2020, 10(14), Published: 21 July 2020,
DOI: 10.3390/app10145001

[12] A. Ogawa, K. Takakura, N. Hirai, H. Kanematsu, D. Kuroda, T. Kougo, K. Sano, S. Terada, Biofilm Formation Plays a Crucial Role in the Initial Step of Carbon Steel Corrosion in Air and Water Environments,
MDPI Materials, 2020, 13(4), 923, Published: 19 February 2020
DOI:10.3390/ma13040923

[13] G. A. O'Toole, Microtiter Dish Biofilm Formation Assay Journal of Visualized Experiments, Exp. (47), e2437 10.3791/2437, Published: 30 January 2011
DOI:10.3791/2437

[14] B. Rybak, N. Wawrzyniak, L. Wolska, M. Potrykus,
Escherichia coli and *Serratia fonticola* ESBLs as a potential source of antibiotics resistance dissemination in the Tricity water reservoirs,
Acta Biochimica Polonica, Vol. 68 No. 3 (2021),
Published: 24 August 2021,
DOI:10.18388/abp.2020_5740

Reference to a conference/congress paper:

[15] B. Rybacki, M. Grzybowski, J. Pawłowski, M. Jasiukowicz, N. Czortek, P. Podpirko, K. Loret, S. Magrian, D. Rekowski, R. Galikowski, B. Krawczyk, Investigation of Microorganisms in the Stratosphere, 4th Symposium on Space Educational Activities, page 832, https://sseasymposium.org/wp-content/uploads/2022/08/SSEA22_Proceedings.pdf (accessed 18.08.2022)

