

Marine propeller shaft bearings under low-speed conditions: water vs. oil lubrication

Wojciech Litwin

Gdansk University of Technology

Faculty of Ocean Engineering and Ship Technology

ul. Narutowicza 11/12

80-233 Gdańsk

Poland

Abstract:

Bearings used in shipbuilding, the hydropower industry and water pumps have undergone a metamorphosis in recent decades. Due to requirements related to environmental protection, it was necessary to refrain from both lubrication with grease and drip lubrication with mineral oil.

Water-lubricated bearings with polymer bushings or sealed systems lubricated with oil are now standard solutions. When properly designed, assembled and operated, bearings can work reliably for years. It turns out, however, that specific operating conditions, such as when the rotational speed of the shaft is low, may result in intensive wear and premature failure. Therefore, a group of four sliding bearings approved for use in shipbuilding was experimentally tested. The test results showed that the choice of bearing type has a key effect on friction during operation with low speed. In some of the tested bearings, static friction is significant, intense slip-stick phenomena appear and they should not be used in applications where work at low speeds is required.

Keywords:

Water lubricated bearings, oil lubricated bearings, marine bearings, stern tube bearings, slip-stick

1. Introduction

Propeller shaft bearings are very crucial elements of a typical propulsion system in ships. For about one hundred and fifty years, since propeller propulsion was used on a ship for the first time, they have been the source of various problems engineers have had to overcome [1].

From the very beginning, two main types of bearings were tested - bearings lubricated with water and bearings lubricated with plastic grease or mineral oil. Each of these solutions has advantages and disadvantages. Water-lubricated bearings with wooden bushings have been successfully used for decades. Today, most of the wood has been replaced by plastics, although there are manufacturers in the world that still offer the former solution. Bearings lubricated with petroleum-based grease in

contact with marine water are an unacceptable solution today because of the great importance attached to environmental protection. Oil lubrication is widely used, although due to the complex construction needed it is not a cheap solution. Despite well-developed sealing systems, the risk of oil leakage still exists and that is why the engineers are currently working on, among other things, biodegradable oils whose possible leakage would not adversely affect the environment.

It is worth noting that each of the solutions has some advantages and disadvantages. Specific solutions are supported and promoted by corporations and a large group of engineers and scientists. They are an interesting source of information about the benefits of their own products and are happy to point out the disadvantages of competing products.

A properly designed, machined and assembled shaft bearing can work reliably for decades. In practice, however, it turns out that the issue is more complex. Design errors, careless assembly, carelessness of the crew and hard work under adverse weather conditions sometimes cause an almost immediate failure [2][3]. There was a case in which a bushing exchange was made just a few days after launching the ship. Excessive, premature wear is also common. Often, after bearing repairs, the shipowner decides on a different technical solution, transferring responsibility for the failure of the bearing to the bushing material manufacturer. There are also cases when expensive bushings made of white metal in an oil-lubricated bearing were replaced by composite bushings made of resin-bonded fibres. However, this bushing replacement caused the temperature in the lubricant film to increase excessively and the composite bushings were not able to dissipate heat to the environment due to the high coefficient of thermal resistance. Long-lasting, excessive temperature increase in the friction zone caused the destruction of the bushing, which delaminated and, thus, destroyed the surface of the bearing bush.

Water-lubricated marine shaft bearings are now being tested in various centres around the world. Research focuses on the following problems, among others:

- bearing operation in full fluid friction, including the assessment of the maximum hydrodynamic load capacity [4],
- assessment of the impact of the bushing materials and the geometry of the bearing interspace on the hydrodynamic properties of the bearing [5],
- assessment of the impact of shaft and bushing misalignment on bearing properties and durability [6][7][8][9],
- the problem of vibration in the propulsion shaft system [10][11] ,
- the problem of inadequate cooling and working in conditions of insufficient lubrication and cooling [12][13],
- research on new sliding couples [14][15][16],



- application of water lubrication to, among others, thrust ball bearings [17][18],
- operation in mixed friction and the stick-slip phenomena [19][20][21][22][23],
- operation during lubrication by a contaminated liquid [24][25],
- operation under high speed [26][27][28][29].

Some of this research was carried out using a purpose designed and built setups in which the construction and operation conditions refers to real cases; some of them were carried out on various types of tribotesters, which tested small samples, often under conditions different from those of marine shaft line bearings.

2. Problem

In most cases, however, bearings are operated without problems and control is carried out only as part of routine dry dock inspections during the so-called renewal of the class, which is carried out by the classification society supervising navigation safety and the technical condition of ships.

However, there are specific cases when typical solutions do not work, e.g. special ships on which the dynamic positioning technique has been used, allowing the ship to maintain a fixed position, e.g. during underwater works. Problems are caused by submarines cruising silently underwater or by frigates or corvettes searching for them on the surface. Practical experience has shown that, often, after several months of operation of such a vessel, it is necessary to overhaul the bearings of the shaft line, which resulted in a temporary ship shutdown.

The problem of excessive, premature wear of the bushing-shaft slip association in the ship's main shaft bearings often results from low rotational speeds when the bearing operates in the mixed friction regime. The rotational speed of the shaft when manoeuvring or maintaining a fixed position can be low, converting the rotational speed into a linear slip speed. The values achieved can be below 0.3 m/s. It should be noted that ship propeller shaft bearings are of a special type. Due to the need to ensure a high level of safety, classification societies have specified that the stern bearing, located next to the propeller, should have a length corresponding to at least two bushing diameters (condition $L / D = 2$). For rubber bearings, the length of the bushing must be up to four shaft diameters. As a result, in bearings of this type, there are low corresponding pressures, in most cases from 0.2 to 0.4 MPa.

To investigate the properties of various types of bearings operating in the low-speed range, it was decided to carry out experimental investigations. A group of bearings typical for shipbuilding was selected for the test. All tests were conducted for brand new bushes. The bush running-in was done along the procedure suggested by provider (about 10 hours of operation with various speeds and loads) . The test stand used was designed and built specifically for ship bearing tests.

3. Testing

A modernized test stand for low-speed tests is shown in Fig. 1.



Figure 1. Test stand for marine stern tube bearings during tests of oil lubricated bearings

The main shaft of the test stand is supported by two rolling bearings. Between them, there is a bearing test unit (Figure 2). An electric motor with a reduction gear was used for the drive. The motor is equipped with a speed control system. It has a starting torque of about 160 Nm. On the shaft (1), the tested bushing was mounted in a massive housing (2) (the picture shows a bushing with a sliding layer made of white metal). The way in which the lubricant was applied depends on the type of bearing being tested. The oil was supplied through two longitudinal grooves in the horizontal plane of the bearing (Figure 2) and flows out of the bearing on both sides (3). In the case of bearings lubricated with water, as in marine systems, the bearing was supplied unilaterally, forcing the longitudinal flow of the medium. The tested sliding bearing bush is closed on both sides through the covers in which the sealing rings (3) are mounted. The load (L) is exerted by a hydraulic cylinder via a hydrostatic bearing (4). The place where the hydrostatic film appears is shown in Figure 2. Separation of the system exerting the load from the bushing unit using a thin layer of oil under pressure enabled precise measurement of friction force (F_f) on 200 mm long arm (R) and calculation of friction torque and the coefficient of friction. For coefficient of friction calculation basic formula was used:

$$F_f \cdot R = \mu \cdot \frac{D}{2} \cdot L$$

Unfortunately, this way of supporting also has a disadvantage. During the tests, there is no control over the position of the axis of the bushing with respect to the axis of the shaft. The bearing behaves similarly to a self-alignment bearing. In the described case, using an oil-lubricated bearing

there was no noticeable skewing of the axis due to the high construction precision of the shaft and bushing and the symmetric supply of lubricant through the longitudinal groove. In bearings lubricated with water fed longitudinally, some slight shaft skewing occurred during operation in liquid friction. In the analysed cases, when bearings were lubricated with water in mixed friction, the skewing effect did not occur.

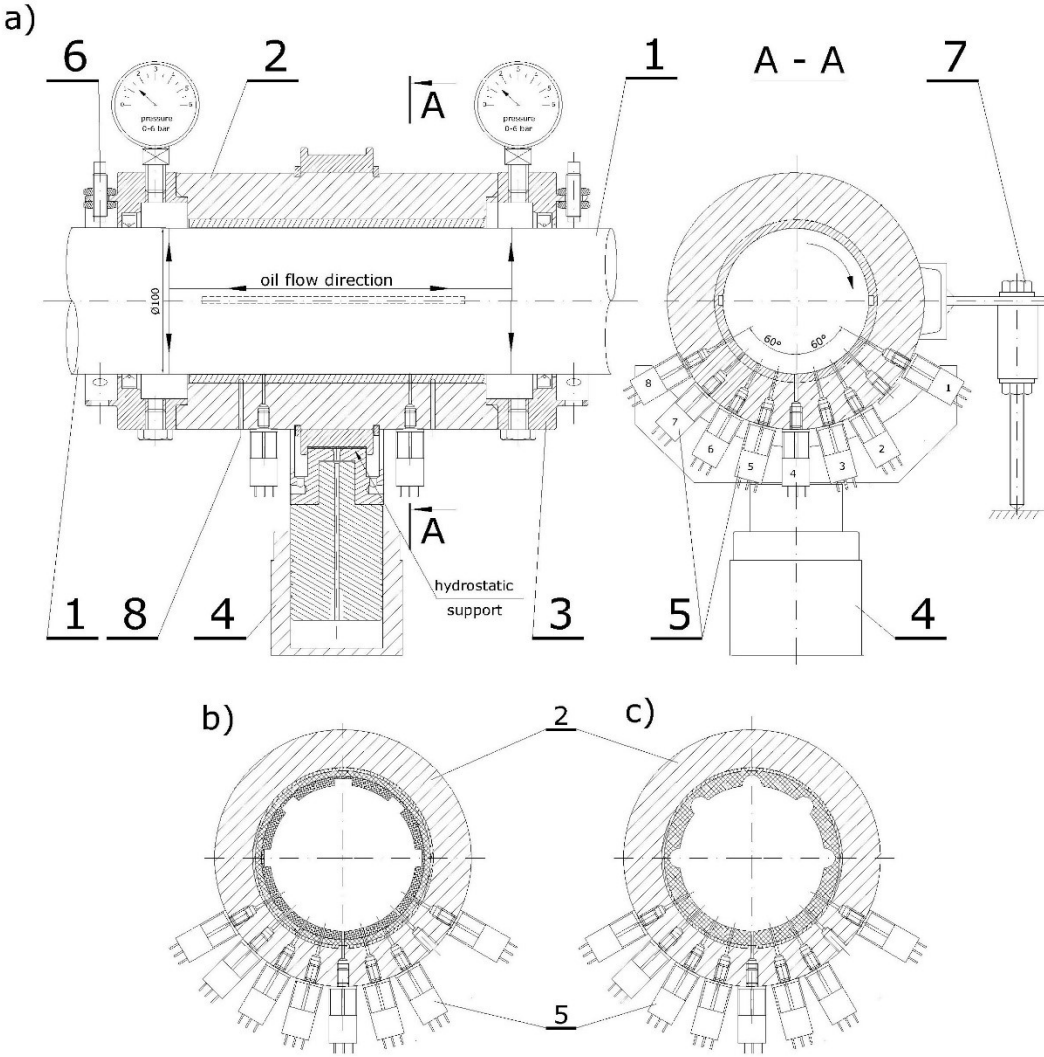

Figure 2. The tested bearing unit, a) cross-section of oil lubricated bearing; 1- main shaft, 2- test bushing assembly, 3- cover with seals, 4 - load exertion system, 5- pressure sensors, 6- distance sensors, 7- friction force sensor, 8 - temperature sensors installed in the bushing sliding layer; b) water lubricated polymer bearing bush unit, c) water lubricated NBR bearing bush

The stand is equipped with two pump units. One uses hydraulic oil to feed the load-applying cylinder (4) and the hydrostatic bearing through which the test bearing is loaded. The radial load value of the tested bearing is controlled by setting a specific supply pressure on the overflow valve. The

second hydraulic unit is used to supply the lubricating oil to the tested bearing. The output of the feed pump and the oil supply pressure can be adjusted. The lubrication system is adapted to mineral oils, synthetic oils and lubricants of a similar viscosity such as esters, glycol, etc. for testing water-lubricated bearings, the lubricant was pumped from the clean water tank and flows into the bearing through the filter.

The movement resistances can be accurately recorded on the test stand thanks to the load exerted by the hydrostatic bearing. Making accurate measurements of the friction force allows the calculation of the coefficient of friction. A small measurement error results from the fact that the friction forces of the bearing and the two sealing rings are registered simultaneously. This is a typical problem and it also appears in other test stands of similar construction. It is believed, however, that the coefficients of friction of the rings are minimal and to further reduce them, the springs pressing the sealing lip were dismantled.

At the test stand, it is possible to measure the distribution of pressure in the lubrication film through sensors installed in the bearing bush. In a typical case, sixteen pressure sensors are installed in the bush, in two groups of eight. The stand is equipped with two pairs of sensors on both sides of the tested bearing, which enables non-contact measurement of the distance between the shaft and the bushing (6). The possibility of rotating the bush loaded by the cylinder on the fixed shaft (after disassembling the friction force sensor) enables the determination of the contact positions of the shaft with the bush so that it is possible to apply the clearance circle diagram to the shaft orbit diagrams. This is a very valuable feature of the test stand and allows for the evaluation of bearing conditions. It is worth to add that usually expected clearance circle is not a perfect circle and it is easy to notice the bushing cylindricity deviation (fig. 9 ÷ 11). What's more for elastic polymers and rubber the bush and journal contact zone expands and becomes bigger.

The test was carried out for four different bearings widely used in the shipbuilding industry (Table 1). All tested bushings are approved by classification societies for use in propeller shaft bearings. The first tested bearing (A) had a white metal bushing and was lubricated with SAE 30 type 3004 engine oil. It is a type commonly used in shipping. For practical reasons, one lubricant is used to lubricate both the internal combustion engine and the shaft tube bearings. This complicated and costly solution, despite the danger it poses for the natural environment, still has a significant group of supporters. The oil was delivered to the bearing via two longitudinal horizontal, non-pass-through grooves.

The other bearings (B, C, D) are water lubricated and can be lubricated by either filtered outboard water or fresh water circulating in a more complex, sealed and closed system. Water was supplied to bearings during testing for one of the covers (figure 2 element 3) forcing longitudinal flow, which is typical for ship propeller shaft bearings lubricated with water. The classic nitrile rubber - NBR (B) was selected for the tests in which longitudinal pass-through grooves were made around the

perimeter. A widely used, flexible polymeric material (C) for tests in which the lubrication grooves were made only in the upper half of the bushing. Tests with a modern three-layered bearing material (D) with a PTFE sliding layer used lubricating grooves, similar to the polymeric bushing (C), only in the upper half of the bushing.

Different bushing geometries for bearings lubricated with water are recommended by specific manufacturers and are intended to obtain specific utility values. The grooves located around the perimeter of the NBR (B) bushing are to allow very good working conditions when lubricating with water containing solid particles. Bushings in which grooves were made only in the upper half (C, D) favour the formation of hydrodynamic phenomena. Tests carried out earlier confirmed the fact that a bearing lubricated with water in typical marine conditions can work in full fluid friction [26,27].

Table 1. Bearing data and operating conditions

		Bearing A	Bearing B	Bearing C	Bearing D
1	Bushing material	White metal (SnSb8Cu3)	NBR	polymer	3 layer (bronze/ NBR/ RTFE)
2	Shaft diameter / bushing length	100 mm / 200 mm			
3	Bearing clearance measured at 20 degrees [mm]	0.27	0.8 ÷ 1 (cylindricity deviation)	0.2 ÷ 0.4 (cylindricity deviation)	0.5 ÷ 0.6 (cylindricity deviation)
4	Sommerfeld number for shaft speed 1 rev/s; oil temperature 40 °C, load 0.4MPa	0.312	-	-	-
5	Bushing geometry	Full bush	grooves	partial arc	partial arc
6	Shaft steel	Carbon steel	X10CrNi18-8 (AISI 301)		
7	Shaft rotational speed	0 – 11 rev/s			
8	Shaft speeds	0.5 rev/s (0.15 m/s) 1 rev/s (0.314 m/s)			
9	Radial load [N] / specific pressure in the bearing [MPa]	4 ÷ 20 kN / 0.2 ÷ 1 MPa	4 ÷ 12 kN / 0.2 ÷ 0.6 MPa		
10	Work temperature	Bushing 50°C Oil 40°C	Ambient 20°C Water 20°C		

The data acquisition system based on PC computer with A/D card and dedicated software. All tests were carried out minimum two times for each bearing to make sure that results are repeatable. The sampling range depended on shaft speed. For every working condition five hundred measurement points were acquired. On diagrams of coefficient of friction calculated uncertainty was placed. All sensors were calibrated before tests.

4. Results

The tests were carried out over a period of about two years when various bearings were subjected to comprehensive tests. This article focuses on the problems of bearing work with low sliding speeds; however, to learn the specifics of the tested bearings, it is worth checking the results of measured resistance of motion/coefficients of friction in a wider, typical work range (Figure 3). The oil

lubricated bearing (A) could be loaded the most and the movement resistance diagram, measured pressure distribution of the film and trajectories of the shaft axis clearly indicated work in the liquid friction regime with a considerable reserve of hydrodynamic load capacity. The coefficient of friction during start-up was not high and amounted to about 0.15. No slip-stick phenomena were found, and even after a longer stop, the shaft resistance during start-up was practically the same.

Water lubricated bearings with a bushing in which grooves were made only in the upper half of the bushing worked in the full fluid friction regime. The full results of this tests were published in previous articles [30][31]. Measured resistance of motion was very low, which results from the low viscosity of the lubricant - water, but the starting resistance was very high and reached 0.5 (C). In the bearing with the polymer layer (C) and with NBR (B), an adhesive slip surface grafting was observed at start-up, the value of which increased with the shutdown time of the shaft. The bearing with an NBR bushing (B) operated in the mixed friction regime in the entire range of working conditions for which measurements were made.

To be clear, for water-lubricated bearings, in particular bearings with NBR (B) and polymer (C) bushings, maximum specific pressures were only 0.6 MPa (12kN). These are the maximum recommended loads defined by the manufacturers. When attempts were made to test for larger loads, it turned out that the stand's maximum torque of 160 Nm is not enough to overcome the resistance to movement during start-up.

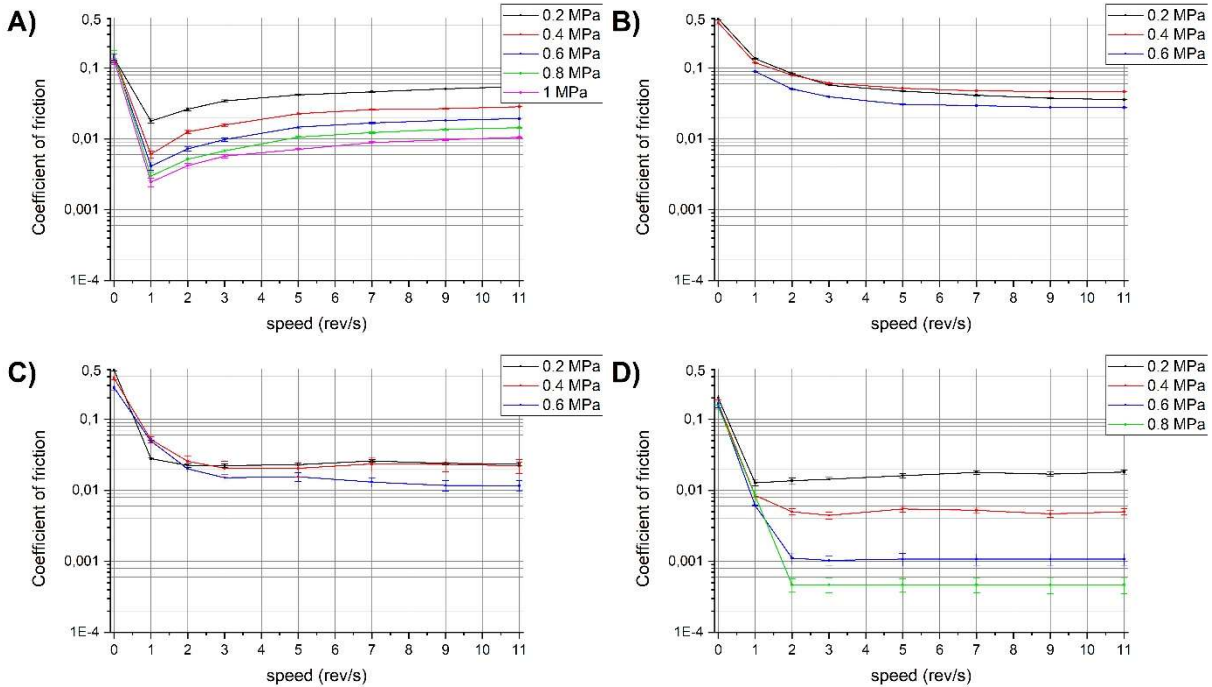

Figure 3. Diagrams of the coefficient of friction; A) oil-lubricated bearing, white metal bushing; bearings lubricated with water: B) NBR bushing, C) polymer bushing, D) 3 layers bushing

The graphs of the friction coefficient recorded for the low shaft rotational speeds of 0.5 and 1 rev/s (linear sliding speed 0.157 and 0.314 m/s) are shown below in Figures 4–7. On each of the graphs, the profile of the coefficient of friction was presented during five consecutive rotations of the shaft. Due to significant differences in the registered values of the coefficient of friction, the graphs were prepared in two different coefficient of friction ranges to present the recorded values and make comparisons easier. Due to very large fluctuations in the friction force for some of the bearings, it was impossible to make precise measurements for loads greater than 0.2 MPa.

For the oil-lubricated bearing (A) and the 3-layer water lubricated bearing (D), the boundary position of a journal in a bushing was identified as a clearance circle, presented in Figures 8 and 9 in the form of two circles defining the contact zone - depending on the pressures and the hard to determine elastic deformation of the bushing. The recorded orbits of the centre of the shaft were placed on the same graph, making it possible to determine the approximate thickness of the lubricating film – if the orbit was located inside of the clearance circles. If the orbit was outside of the clearance, such a case sometimes take place for very elastic bushes, film thickness estimation is impossible. Even if hydrodynamic lubrication appear the film thickness is very low.

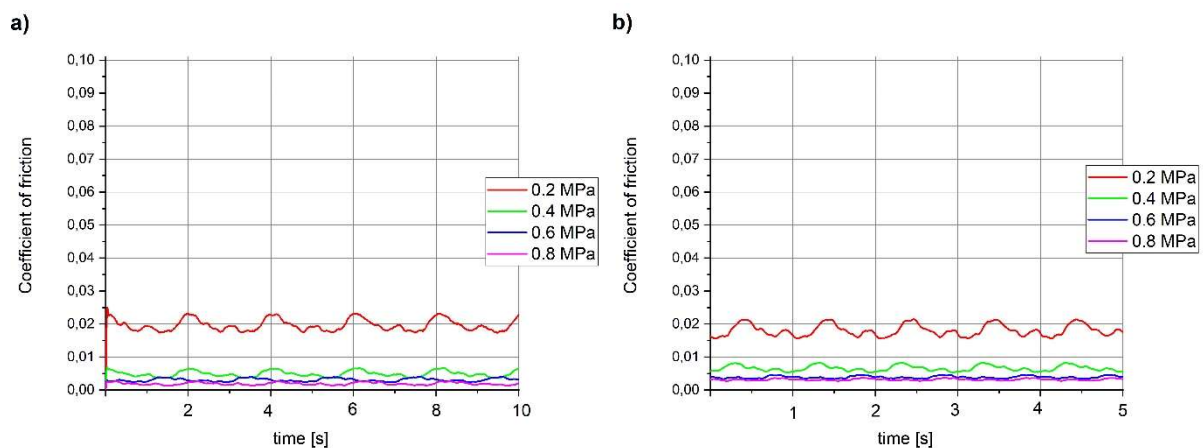

Figure 4. Graph of the coefficient of friction for an oil-lubricated bearing with a white metal bushing (A); a) 0.5 rev/s shaft rotational speed, b) 1 rev/s shaft rotational speed

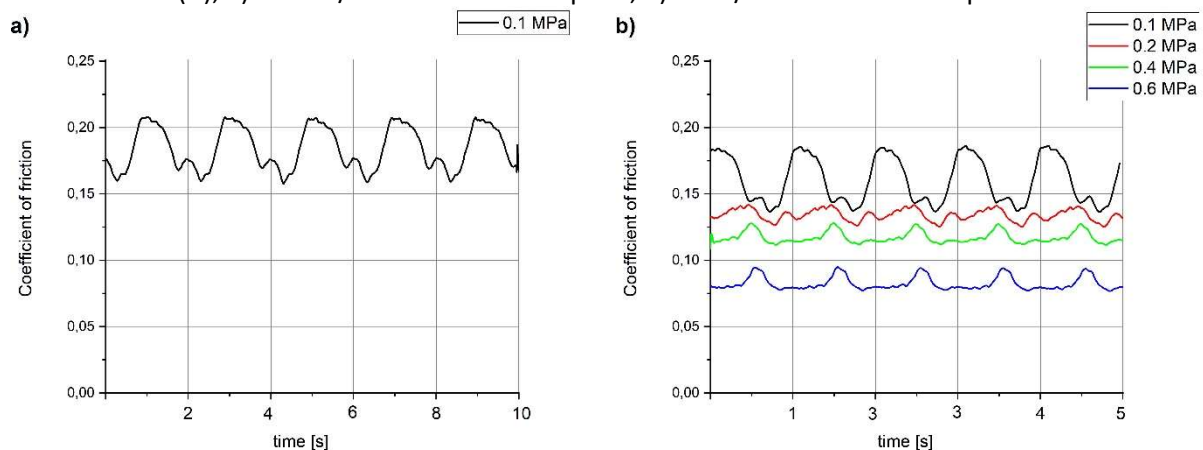

Figure 5. Graph of the coefficient of friction for a bearing lubricated with water with an NBR (B) bushing; a) 0.5 rev/s shaft rotational speed (linear sliding speed 0.157 m/s), b) 1rev/s shaft rotational speed (linear sliding speed 0.314 m/s)

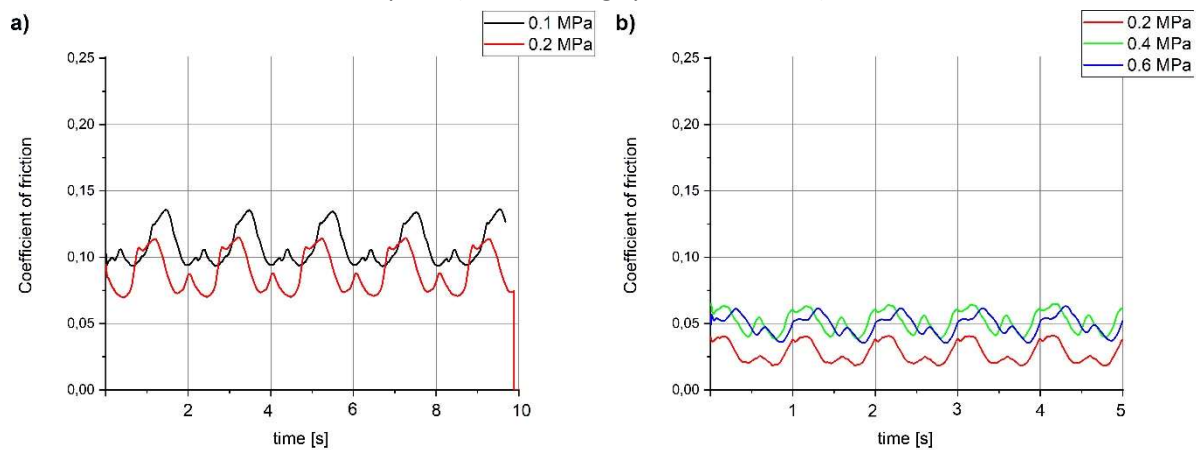

Figure 6. Graph of the friction coefficient for a water-lubricated bearing with a polymer(C) bushing; a) 0.5 rev/s shaft rotational speed (linear sliding speed 0.157 m/s), b) 1rev/s shaft rotational speed (linear sliding speed 0.314 m/s)

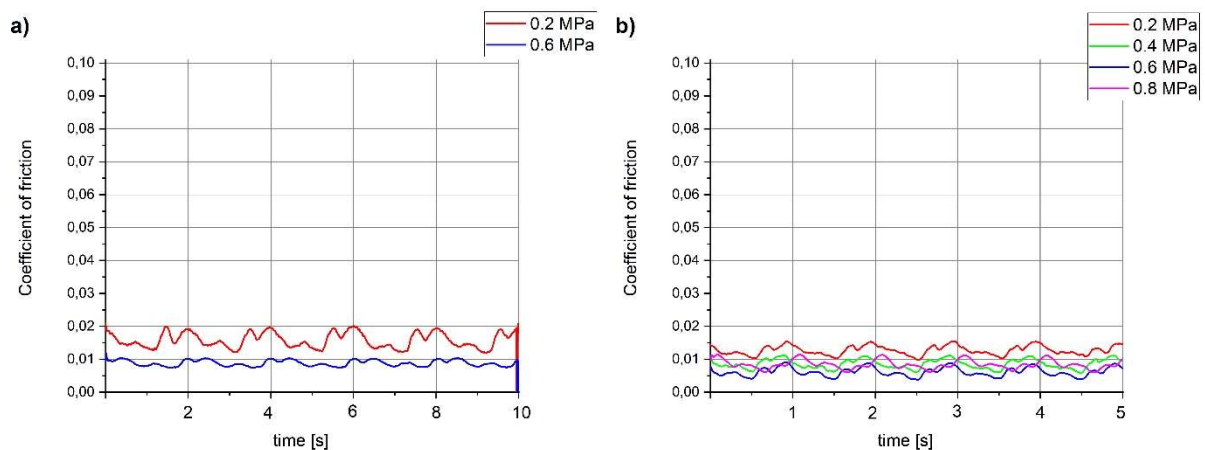

Figure 7. Graph of the coefficient of friction for a bearing lubricated with water with a three-layer bushing (D); a) 0.5 rev/s shaft rotational speed (linear sliding speed 0.157 m/s), b) 1rev/s shaft rotational speed (linear sliding speed 0.314 m/s)

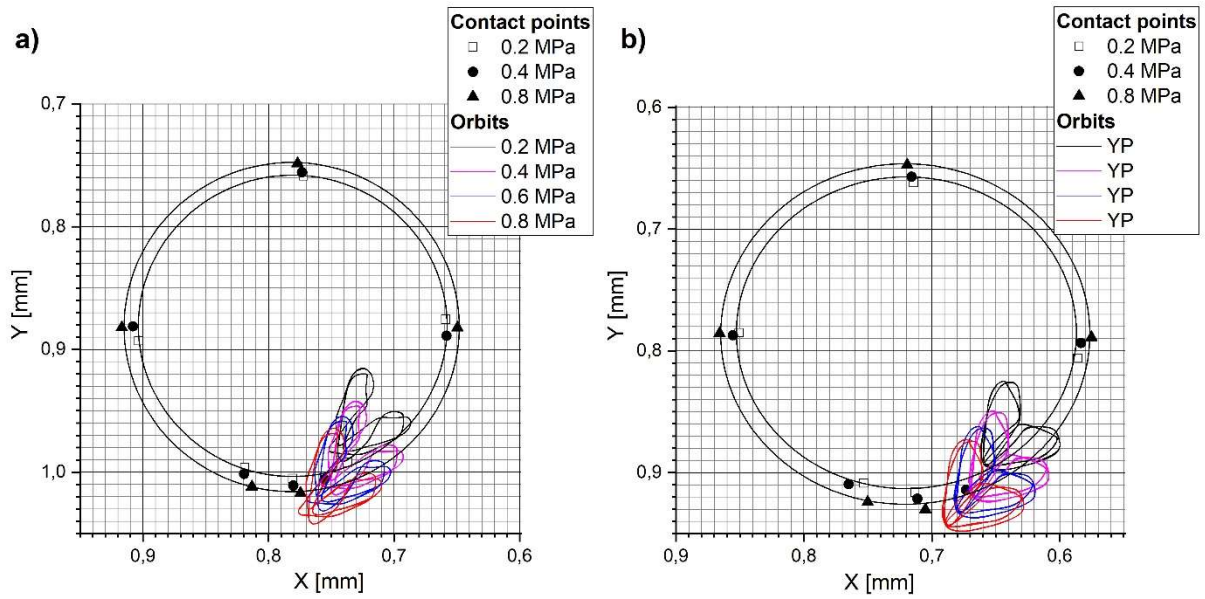

Figure 8. Orbits of the shaft axis for an oil-lubricated bearing for two rotational speeds a) 0.5 rev/s shaft rotational speed (linear sliding speed 0.157 m/s), b) 1 rev/s shaft rotational speed (linear sliding speed 0.314 m/s)

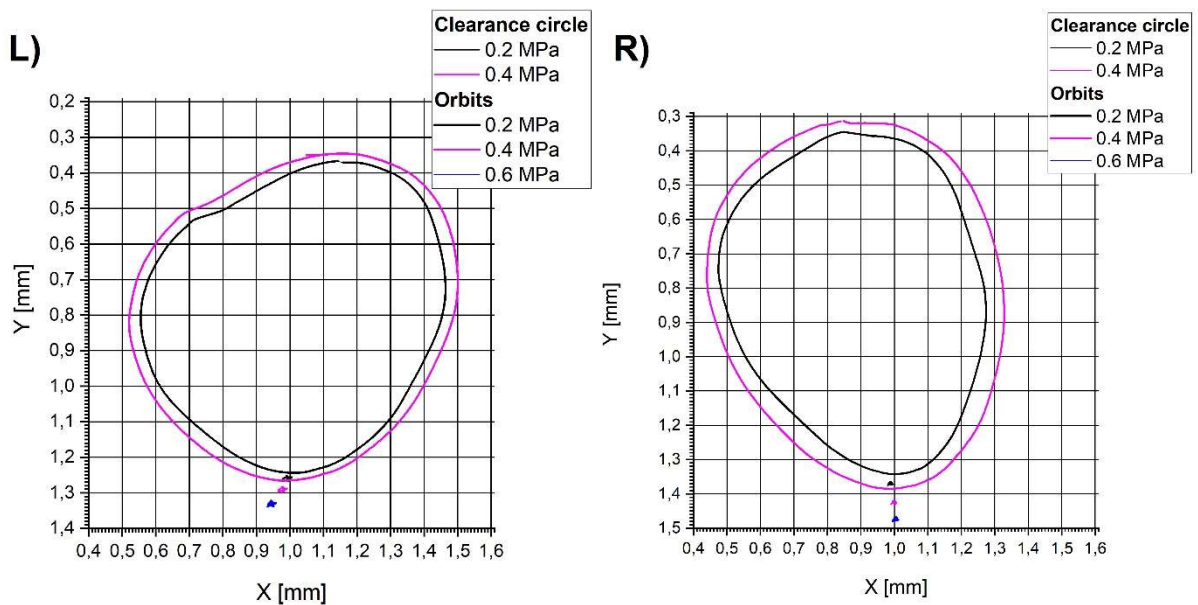

Figure 9. Orbits of the axis of the shaft for a bearing lubricated with water with a NBR bushing on the right (R) and left (L) side of the bearing tested, rotational speed of 1 rev/s

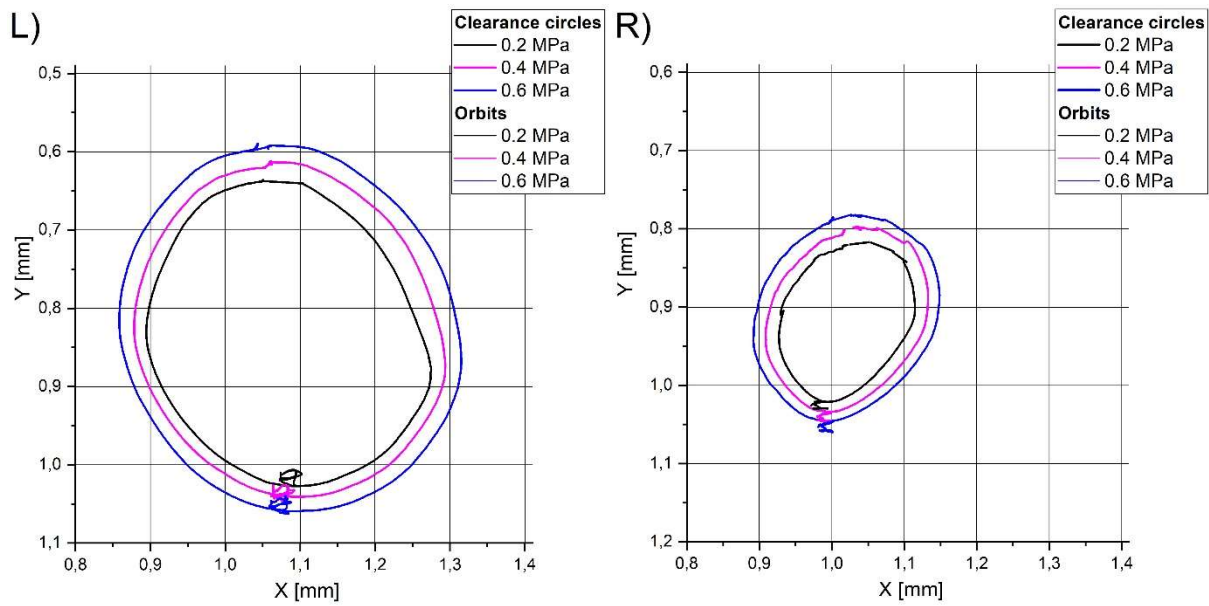

Figure 10. Orbits of the axis of the shaft for a bearing lubricated with water with a polymer bushing on the right (R) and left (L) side of the bearing tested, rotational speed of 1 rev/s

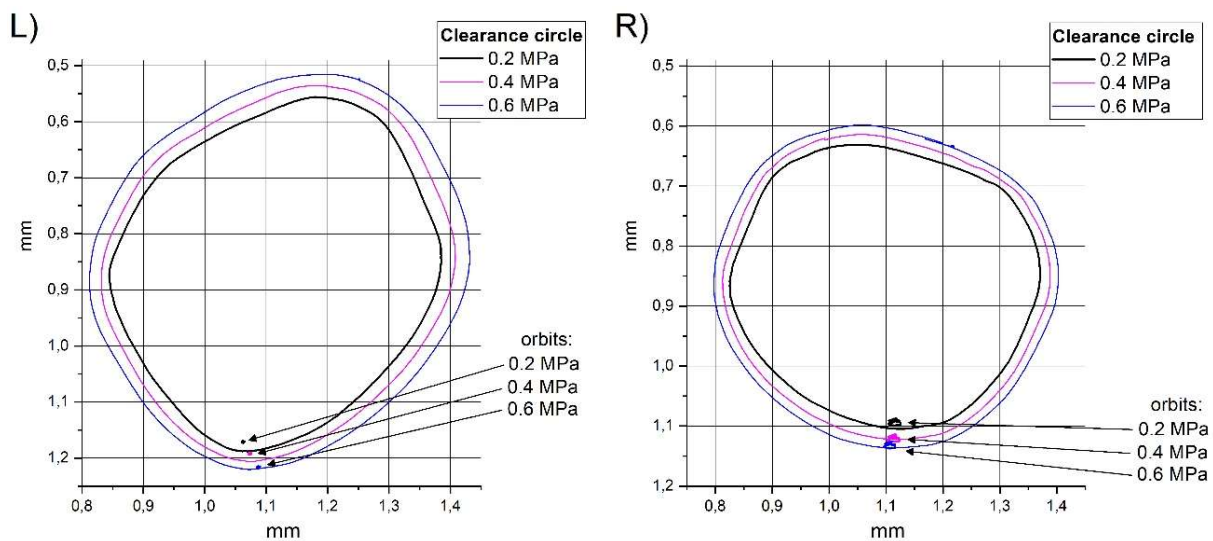

Figure 11. Orbits of the axis of the shaft for a bearing lubricated with water with a three-layer bushing on the right (R) and left (L) side of the bearing tested, rotational speed of 1 rev/s

5. Discussion

The conducted measurements show significant differences between the properties of the tested bearings. Measurements made for typical conditions when the shaft speed is between 3 and 11 rev/s have shown that the oil-lubricated bearing (A), water-lubricated with a polymer bushing (C) and the three-layer bushing (D) operated in the full fluid friction regime. This is confirmed by pressure measurements in the lubricating film [26][27]. Lubricating films in the case of bearings lubricated with water had a lower thickness than in an oil-lubricated bearing, which results from the significant

difference in viscosity of the lubricant and large diameter clearance, three times bigger than in oil lubricated bearing (A). The bearing with the NBR bushing on which the lubrication grooves were made had clearly worse hydrodynamic properties. In the whole range of loads and rotational speeds, it worked in the regime of mixed friction [26][27]. This is due to the geometry of the bushing, which makes it difficult to create a bearing lubricating film, the geometry errors of the bushing and the condition of the surface (roughness), which, despite long operation, remained imperfect. It is also worth mentioning that after operating the bearings lubricated with water with polymer (C) and NBR bushings (B), a slip-stick phenomenon was observed. A few hours standstill with the bearing under load caused the starting resistance to increase up to twofold [26][27]. Coefficients of friction during start-up, shown in the diagrams (fig. 3), were found by calculating the average value from several successive starts performed every few minutes. Therefore, even though the coefficients of friction reach a value of 0.5, this is not the maximum value that can be expected in actual operation, which may be accompanied by longer breaks at work. The significant starting resistances and the presence of a slip-stick phenomenon for water-lubricated bearings with polymeric and NBR bushings (fig. 5 and 6) lead to questions about the durability of the bearing at low rotational speeds.

The measurements of motion resistance and corresponding friction coefficient diagrams are interesting (fig. 4–7). The difference in the coefficient of friction is easy to notice. The lowest motion resistance was recorded for an oil-lubricated bearing and a three-layer water-lubricated bearing with a PTFE sliding surface. The recorded friction force values were so small that one could have concerns about the error caused by the seals. The values of the coefficient of friction presented on the graphs reach a value of about 0.002, which allows us to suppose that they are actually half as much. Therefore, it can be concluded that both bearings (A and D) are best suited for low-speed operation.

The shaft orbits in the oil lubricated bearing (fig. 8) show a relatively large orbit, which is not without significance for the dynamic properties of the power unit, but during operation, the shaft journal does not come into contact with the bush. This means that a fluid film appears in the bearing interspace. Its thickness is difficult to estimate because it is practically impossible to get experimental local deformation of the bushing under the influence of hydrodynamic pressure. The large orbit of the shaft centre indicates a large difference in pressure in the lubricant film (hydrodynamic pressure pulsations).

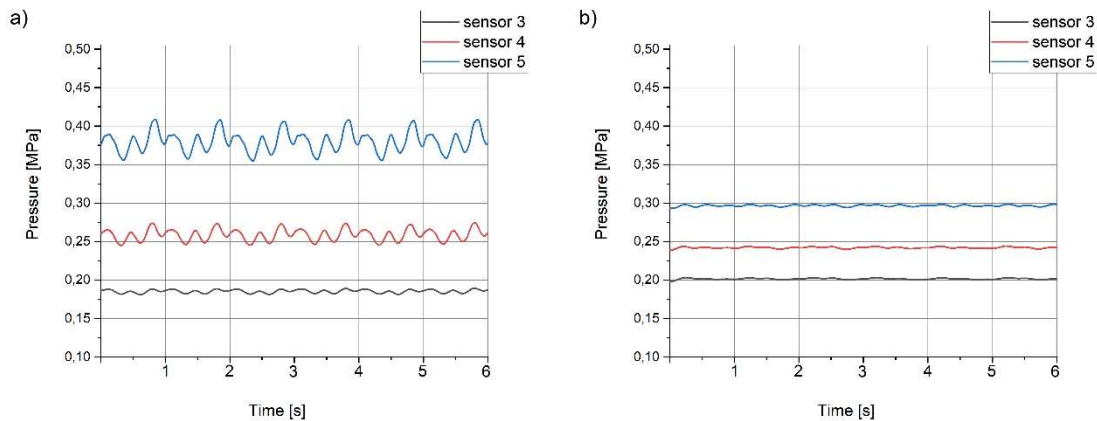

Figure 12. Hydrodynamic pressure pulsation acquired by three bottom pressure gauges 3,4 and 5 in oil lubricated bearing (A), a) shaft speed 1 rev/s, b) shaft speed 9 rev/s (linear sliding speed 2.8 m/s)

For speeds of 0.5 rev/s, the film thickness is probably below 5 μm and for 1 rev/s it amounts to a little over 5 μm . It is worth noting that large pulsations of hydrodynamic pressure can be detrimental to the bearing, especially when thin-walled, multi-layer bushings are used with a thin white metal sliding layer. There were reports on cases where the layers got separated and the bushing was damaged [32].

It is also noteworthy that the experimentally verified shape of the clearance circle (fig. 8) shows the significant advantage of metal bushings and therefore virtually perfect cylindrical shape. The area between the two circles shows the zone of possible contact of the journal and the bushing depending on the size of the applied load and, thus, the elastic deformation of the bushing.

Results acquired for water lubricated bearings are very different (fig. 9 ÷ 11). Differences in clearance circles shape, when compared to a white metal bush are clearly visible. There are two most important differences. The first is shape. Different shape on both bush sides (left and right) shows significant imperfection in bush cylindricity. The second important difference is clearance circles size. This both imperfections are result mostly of manufacturing process (polymer bush internal turning) and water soaking and swelling. It is worth to notice that in real cases such a imperfections are typical and calculations conducted for full fluid bearings with polymer bushes are usually made with assumption of bush cylindricity.

Other important factor is bearing bush elasticity. This parameter is important for bush hydrodynamic properties and in case of shaft misalignment. The acquired clearance circles for non-metal bushes (figures 9 – 11) under various loads (0.2 – 0.6 MPa specific pressure) significantly increased. Such an effect for the same loads is negligible for white metal bush [33].

For water lubricated bearings with polymer bushes it is usually hard to estimate a film thickness even when orbits are very small (fug. 11).

Therefore, in a bearing with an elastic NBR bush, it is not possible to reliably evaluate the thickness of the lubricating film due to the significant deformation of the elastic sliding surface. It is certain that the lubricant film is very thin and locally, especially at the edges of the bushing, it can contact the bush. This phenomenon leads to fast lapping of the edge of the bushing and has been described earlier [7].

Coefficients of friction for bearings lubricated with water with NBR and polymer bushings (B, C) were significantly higher than in previously described cases. The difference was about ten times, with clear differences in the temporary friction coefficient values observed. This results from the slip-stick phenomenon in the bearing.

6. Conclusions

The increase in the public's awareness of the growing pollution of the natural environment is one of the main reasons why ecological solutions are being sought for newly built and refurbished facilities such as ships, water turbines or pumps. It is also important that a lot of attention is paid to the reliability and durability of the solutions used. These are the main reasons for research on increasingly perfect bearings. On the other hand, searching for savings and fierce competition between device manufacturers means that the price of a product is often the first criterion when choosing a specific solution. Modern, environmentally-friendly bearings are today used successfully in many different applications. It turns out, however, that in specific working conditions they do not always show satisfactory durability and reliability.

Low rotational speeds are undoubtedly difficult working conditions. The low slip speed means that a bearing lubricating film is usually not formed in the bearing, especially when the fluid has a low-viscosity, e.g. water. T

he tests have shown that in low rotational speeds, water-lubricated bearings worked in the mixed friction regime; thus, in conditions when the wear process proceeds throughout the whole working time. Additionally, smoothing the surface of the bushing because of the lapping process and then the progressive wear process makes slip-stick phenomena very important. They significantly increase the motion resistance.

The tests showed a certain relationship between the static coefficient of friction and the resistance of movement during operation in the mixed friction regime when the shaft is operated at low rotational speeds. In the case of a bearing with an NBR (B) or polymer (C) bushing, which had by far the highest static friction coefficients, resistance during low-speed operation was also the highest. Among the tested bearings, the oil lubricated bearing and the bearing with a PTFE- sliding layer were the best in terms of operation. The use of a lubricating medium with a viscosity higher than water made the bearing work in the full fluid friction regime. The 3-layer water lubricated bearing (D)

probably worked in the mixed friction regime with a certain degree of full fluid friction. This is indicated by the low values of the coefficient of friction and the registered pressure distribution values in the lubricating film.

These tests will be continued on a newly created test stand that will allow testing at low rotational speeds. The device is designed for high torque to ensure smooth operation and the ability to precisely record motion resistance during start-up.

ACKNOWLEDGEMENTS:

This work was a part of research grant no. 2016/23/B/ST8/03104 entitled "Research on water lubricated sliding couples in unfavourable operation conditions" financed by the Polish National Science Centre.

References

- [1] R. Orndorff, "Water lubricated rubber bearings, history and new developments," *Nav Eng J*, pp. 39–52, 1985.
- [2] H. Hirani and M. Verma, "Tribological study of elastomeric bearings for marine propeller shaft system," *Tribol. Int.*, vol. 42, no. 2, pp. 378–390, 2009.
- [3] S. M. Muzakkir, K. P. Lijesh, and H. Hirani, "Tribological failure analysis of a heavily-loaded slow speed hybrid journal bearing," *Eng. Fail. Anal.*, vol. 40, pp. 97–113, 2014.
- [4] W. Litwin, "WATER LUBRICATED MARINE STERN TUBE BEARINGS – ATTEMPT AT ESTIMATING HYDRODYNAMIC CAPACITY," *Int. Jt. Tribol. Conf.*, pp. 1–3, 2009.
- [5] W. Litwin, "MARINE WATER LUBRICATED STERN TUBE BEARINGS - DESIGN AND OPERATION PROBLEMS," *Int. Jt. Tribol. Conf.*, pp. 1–3, 2007.
- [6] T. He, D. Zou, X. Lu, Y. Guo, Z. Wang, and W. Li, "Mixed-lubrication analysis of marine stern tube bearing considering bending deformation of stern shaft and cavitation," *Tribol. Int.*, vol. 73, pp. 108–116, 2014.
- [7] W. Litwin, "Influence of local bush wear on water lubricated sliding bearing load carrying capacity," *Tribol. Int.*, vol. 103, 2016.
- [8] P. G. Nikolakopoulos and C. a. Papadopoulos, "A study of friction in worn misaligned journal bearings under severe hydrodynamic lubrication," *Tribol. Int.*, vol. 41, no. 6, pp. 461–472, 2008.
- [9] W. Litwin, A. Olszewski, and M. Wodtke, "Influence of Shaft Misalignment on Water Lubricated Turbine Sliding Bearings with Various Bush Modules of Elasticity," *Key Eng. Mater.*, vol. 490, pp. 128–134, 2011.
- [10] T. A. Simpson, F. M. Co, and R. A. Ibrahim, "Nonlinear Friction-Induced Vibration in Water-

Lubricated Bearings,” *J. Vib. Control*, vol. 2, pp. 87–113, 1996.

- [11] S. Liu and B. Yang, “Optimal placement of water-lubricated rubber bearings for vibration reduction of flexible multistage rotor systems,” *J. Sound Vib.*, vol. 407, pp. 332–349, 2017.
- [12] W. Litwin and C. Dymarski, “Experimental research on water-lubricated marine stern tube bearings in conditions of improper lubrication and cooling causing rapid bush wear,” *Tribol. Int.*, vol. 95, pp. 449–455, 2016.
- [13] S. Yamajo and F. Kikkawa, “Development and Application of PTFE Compound Bearings,” *Dyn. Position. Conf.*, 2004.
- [14] W. Litwin and A. Olszewski, “Assessment of possible application of water-lubricated sintered brass slide bearing for marine propeller shaft,” *Polish Marit. Res.*, vol. 19, no. 76, pp. 54–61, 2012.
- [15] W. Litwin, “Influence of local bush wear on properties of water lubricated marine stern tube bearings,” *Polish Marit. Res.*, vol. 18, no. 1, pp. 32–36, 2011.
- [16] Y. Zhimin *et al.*, “Study on tribological and vibration performance of a new UHMWPE/graphite/NBR water lubricated bearing material,” *Wear*, vol. 332–333, pp. 872–878, 2015.
- [17] M. Wodtke and M. Wasilczuk, “Evaluation of apparent Young’s modulus of the composite polymer layers used as sliding surfaces in hydrodynamic thrust bearings,” *Tribol. Int.*, vol. 97, pp. 244–252, 2016.
- [18] M. Wasilczuk, M. Wodtke, and W. Braun, “Centrally Pivoted Tilting Pad Thrust Bearing with Carbon-Based Coated Collar—Experimental Results of Low- and Medium-Speed Operation,” *Tribol. Trans.*, vol. 58, no. 5, pp. 882–893, 2015.
- [19] D. Michalopoulos and A. Dimarogonas, “Stick-Slip of Rotors in Fluid Bearings at Very Low Speeds,” *Wear*, vol. 70, pp. 303–309, 1981.
- [20] S. Maegawa, F. Itoigawa, and T. Nakamura, “Dynamics in sliding friction of soft adhesive elastomer: Schallamach waves as a stress-relaxation mechanism,” *Tribol. Int.*, vol. 96, pp. 23–30, 2016.
- [21] B. Bhushan, “Stick-Slip Induced Noise Generation in Water-Lubricated Compliant Rubber Bearings,” *J. Lubr. Technol.*, vol. 102, pp. 201–210, 1980.
- [22] S. Thörmann, M. Markiewicz, and O. von Estorff, “On the stick-slip behaviour of water-lubricated rubber sealings,” *J. Sound Vib.*, vol. 399, pp. 151–168, 2017.
- [23] C. Dong, L. Shi, L. Li, X. Bai, C. Yuan, and Y. Tian, “Stick-slip behaviours of water lubrication polymer materials under low speed conditions,” *Tribol. Int.*, vol. 106, no. October 2016, pp. 55–61, 2017.
- [24] Z. Guo, C. Yuan, A. Liu, and S. Jiang, “Study on tribological properties of novel biomimetic



- material for water-lubricated stern tube bearing,” *Wear*, vol. 376–377, pp. 911–919, 2017.
- [25] C. Yuan, Z. Guo, W. Tao, C. Dong, and X. Bai, “Effects of different grain sized sands on wear behaviours of NBR/casting copper alloys,” *Wear*, vol. 384–385, pp. 185–191, 2017.
- [26] B. Chen, J. Wang, N. Liu, and F. Yan, “Synergetic Effect of Lubricant Additive and Reinforcement Additive on the Tribological Behaviors of PEEK-based Composites under Sea Water Lubrication,” *Tribol. Trans.*, no. April 2013, p. 130301143734007, 2013.
- [27] R. Colsher, I. Anwar, J. Dunfee, and M. Kandl, “Development of Water Lubricated Bearing for Steam Turbine Application,” *J. Lubr. Technol.*, vol. 105, no. 3, p. 318, 1983.
- [28] S. Dousti, P. Allaire, B. Nichols, J. Cao, and T. Dimond, “Dynamic properties of multi-lobe water lubricated bearings with temporal and convective inertia considerations,” *Proc. ASME Turbo Expo*, vol. 7A–2017, p. 2019, 2017.
- [29] S. Tadayoshi, “Nonlinear Vibration of Saturated Water Journal Bearing and Bifurcation Analysis,” *J. Vib. Acoust.*, vol. 141, no. April, pp. 434–435, 2019.
- [30] W. Litwin, “Properties comparison of rubber and three layer PTFE-NBR-bronze water lubricated bearings with lubricating grooves along entire bush circumference based on experimental tests,” *Tribol. Int.*, vol. 90, 2015.
- [31] W. Litwin, “Experimental research on water lubricated three layer sliding bearing with lubrication grooves in the upper part of the bush and its comparison with a rubber bearing,” *Tribol. Int.*, vol. 82, pp. 153–161, 2015.
- [32] W. Litwin, “Water-lubricated bearings of ship propeller shafts - Problems, experimental tests and theoretical investigations,” *Polish Marit. Res.*, vol. 16, no. 4, 2009.
- [33] W. Litwin, “Experimental research on marine oil-lubricated stern tube bearing,” *J Eng. Tribol. 0(0)*, vol. 0, no. 0, pp. 1–9, 2019. DOI: 10.1177/1350650119846004