

doi:10.15199/48.2015.08.15

Metrological analysis of an computerized system of protection against electric shock in circuits with variable speed drives

Abstract. Drive systems, that can be operated at variable speed, are equipped with power electronics converters. This causes distortion of the earth current, and consequently the need to take into account the use of proper protective devices in relation to earth current harmonics. This paper presents a system for protection against electric shock in circuits with power electronics converters and metrological analysis indicating the requirements for the present measurements for this purpose. The reasons for errors in rms current measurement have also been presented in this paper.

Streszczenie. Układy napędowe o regulowanej prędkości kątowej zawierają przekształtniki energoelektroniczne, które są przyczyną odkształcenia prądu ziemnozwarciowego. Wyższe harmoniczne tego prądu utrudniają dobór zabezpieczeń przeciwporażeniowych i ocenę skuteczności ochrony przeciwporażeniowej. W artykule przedstawiono analizę metrologiczną systemu ochrony przeciwporażeniowej, który może być zastosowany w układach napędowych z przekształtnikami. Zwrócono uwagę na problem detekcji odkształconego prądu ziemnozwarciowego, w szczególności na przyczyny błędów pomiaru wartości skutecznej prądu. (Analiza metrologiczna komputerowego systemu ochrony przed porażeniem w układach napędowych o regulowanej prędkości kątowej).

Keywords: electrical safety, non-sinusoidal currents, touch current, metrological analysis.

Słowa kluczowe: bezpieczeństwo elektryczne, prądy niesinusoidalne, prąd dotykowy, analiza metrologiczna.

Introduction

Every electric circuit must be designed and performed in a way that gives effective protection against electric shock. In case of direct or indirect contact, when the risk of electrocution exist, the disconnection of supply should occur. In practice, shock hazard is analyzed almost exclusively for two typical current waveforms: sinusoidal AC (50/60 Hz) and smooth DC. Basic guidance of effect of these currents on a person is included in the document IEC/TS [1]. Figure 1 presents conventional time-current zones of effect of AC current (15÷100 Hz) on person on the basis of this document. The most important is curve c_1 – beyond it ventricular fibrillation may occur. The probability of ventricular fibrillation of about 5% is for currents between c_1 and c_2 , and about 50% is for currents between c_2 and c_3 . Beyond curve c_3 the probability is higher than 50%.

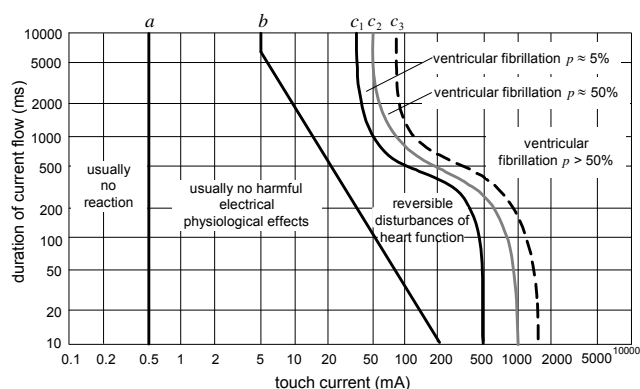

Fig.1. Conventional time-current zones of effect of AC current (15÷100 Hz) on person [1]; p – probability of ventricular fibrillation

Nowadays in electrical installations power electronics converters are commonly used and due to their properties distorted waveforms of earth (touch) currents may flow. Very popular are circuits with variable speed drives. A motor is supplied via frequency converter then (Fig.2) and in case of earth fault or direct contact at the motor terminals strong distorted earth (touch) current flows.

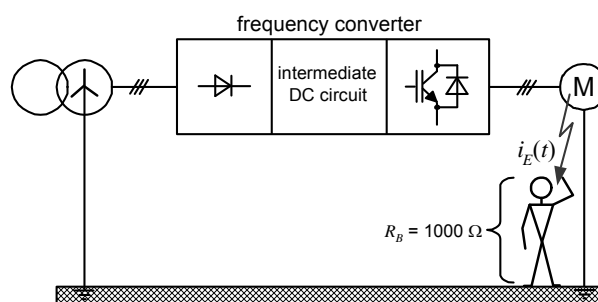

Fig.2. Simplified diagram of the variable speed drive circuit for earth fault current $i_E(t)$ analysis. R_B – human body resistance

The waveform shape depends on actual motor speed and PWM frequency [2-6]. For such distorted current waveform the safety criteria presented in Figure 1 cannot be directly applied. For safety of persons in circuits with variable speed drives, where strong distorted earth current flows, a computer system for evaluation of shock hazard has been performed [7]. The effectiveness of this system mainly depends on accurate data acquisition. An analysis of the accuracy of the computer system is the goal of this paper.

Earth currents in circuit with variable speed drives

In order to recognise current harmonics in a typical circuit with variable speed drive, a laboratory test was performed [8]. One of the motor phase terminal was line-to-earth short-circuited by low inductance resistor $R_B = 1000 \Omega$ (typical human body resistance) and earth current waveform $i_E(t)$ was recorded and analyzed (Fig.2).

Earth fault was performed for PWM frequency 3 kHz and various motor speeds, in particular:

- rated motor speed – motor frequency equal to 50 Hz,
- medium motor speed – motor frequency equal to 30 Hz,
- low motor speed – motor frequency equal to 10 Hz,
- extremely low motor speed – motor frequency equal to 1 Hz.

Figure 3 presents the example oscillograms of the measured earth fault currents.

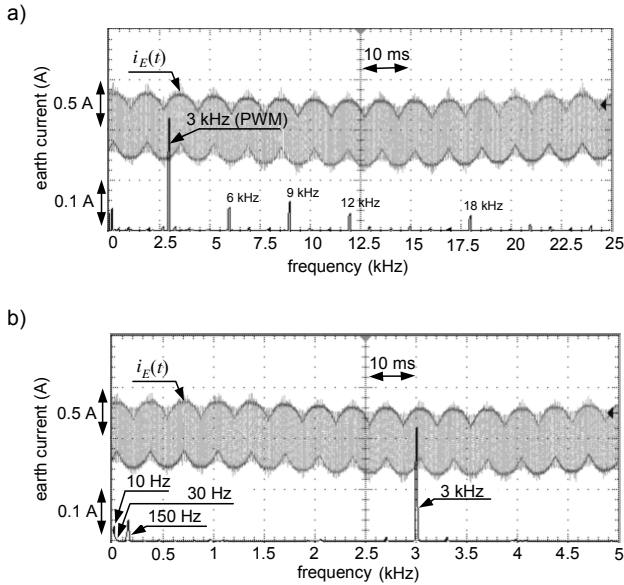

Fig.3. Earth current $i_E(t)$ in the tested circuit with variable speed drive; PWM frequency 3 kHz, motor frequency 10 Hz, current spectrum within the range: a) 0÷25 kHz, b) 0÷5 kHz

The earth fault current comprises a low frequency component which depends on the actual motor speed, a constant 150 Hz component and a component at the PWM frequency and its multiple. The value of the current of motor frequency and the PWM current changes as a function of the motor speed and frequency (Fig.4). For the 50 Hz operating frequency the value of 50 Hz component exceeds the value of PWM component. For very low motor frequency – inversely.

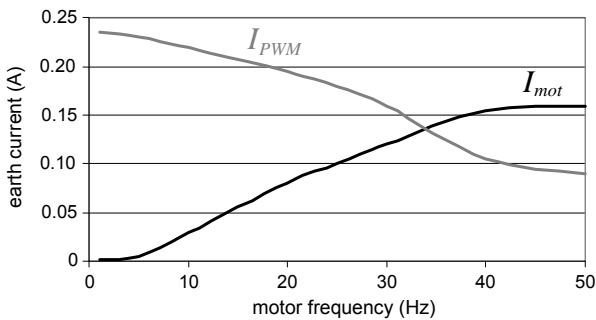

Fig.4. Earth current components as a function of motor frequency: I_{PWM} – PWM frequency component, I_{mot} – motor frequency component

In order to evaluate shock hazard for current with harmonics, the guidance included in the document [9] should be taken into consideration. This document indicates the method of equivalent sinusoidal current I_{eq} calculation (approximate calculation of rms value in terms of the threshold of ventricular fibrillation), when touch current with harmonics flows [9]:

$$(1) \quad I_{eq} = \sqrt{\sum_{h=1}^n \left(\frac{I_h}{F_{fh}} \right)^2}$$

where:

I_h – value of particular harmonic, F_{fh} – frequency factor depending on frequency of particular harmonic.

The values of the frequency factor are presented in Figure 5.

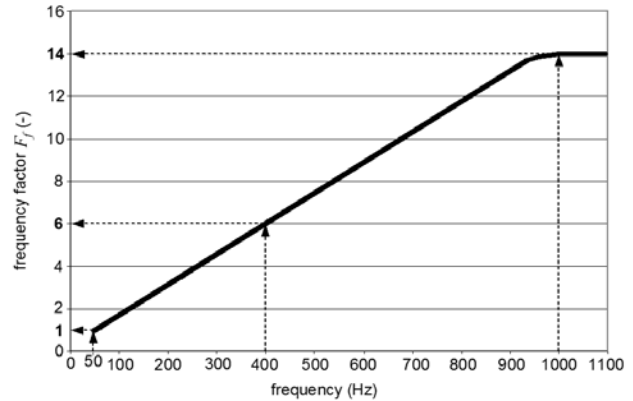

Fig.5. Frequency factor F_f for calculation of the threshold of ventricular fibrillation within the 50 Hz to 1100 Hz frequency range

One can see, that high frequency currents are less dangerous for persons than these of low frequency – e.g. frequency component of 1000 Hz is divided by coefficient equal to 14. The computer system for evaluation of shock hazard in circuit with non-sinusoidal earth currents mentioned above has been performed on the base of the formulae (1) and the graph presented in Figure 5. This system uses LabVIEW environment.

The computer system for safety of persons

Detailed presentation of the computer system is included in [7]. The system is connected to a residual current sensor for detection of residual current in a circuit with a frequency converter (Fig.6). In case of detection of a residual current (earth fault current or touch current), the computer system analyses its waveform, calculates equivalent sinusoidal current I_{eq} according to (1) and decides whether to disconnect or not the supply (via opening a circuit breaker).

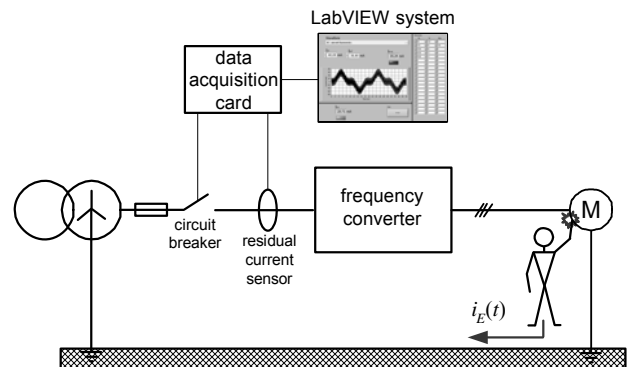

Fig.6. The computer system implemented in a circuit with a variable speed drive

The proposed computer system comprises of:

- a residual current sensor with voltage output,
- a data acquisition module (DAQ-M) with analog-digital converter and digital output,
- a PC computer with LabVIEW environment.

Voltage signal from a residual current sensor is delivered to the analog input of DAQ-M. Taking into account

voltage range of the input signal and sampling frequency, a typical DAQ-M may be used.

When earth fault current reaches a predetermined level and disconnection of supply should occur, appropriate signal from DAQ-M for opening the circuit is delivered to a circuit breaker (or contactor) installed in the main circuit of the frequency converter. In order to initiate disconnection of supply for desired residual current value, very important is proper evaluation every harmonic value of distorted current. The accuracy of this evaluation depends on the implemented data acquisition system.

Selection of the sampling frequency and the number of samples

The main problem with signal acquisition is the proper selection of the sampling frequency and the number of samples. The values of these quantities depend on the assumed width of the spectrum and its resolution.

The width of the f_m spectrum can be determined based on the f_s sampling frequency and the N number of samples according to [10]:

$$(2) \quad f_m = \frac{1}{2} \left(1 - \frac{2}{N} \right) f_s$$

For a large number of N samples it is preferred to use an approximate dependency:

$$(3) \quad f_m = \frac{1}{2} f_s$$

Since, as demonstrated above, the influence of high frequency components is smaller, it is assumed that the component will be included in the range to 10 kHz. Thus, the minimum sampling rate is:

$$(4) \quad f_s = 2f_m = 2 \cdot 10 \text{ kHz} = 20 \text{ kHz}$$

The f_w spectra resolution can be determined as the reciprocal of the length of the T_w time window [10]:

$$(5) \quad f_w = \frac{1}{T_w} = \frac{f_s}{N}$$

Hence, the minimum number of samples to be collected can be determined from the dependency:

$$(6) \quad N = \frac{f_s}{f_w}$$

In the presented case, the resolution, with exact measurements, should be at 1 Hz. Hence, $N = 20 \text{ kHz} / 1 \text{ Hz} = 20000$. Assuming that the number of samples should be a 2 squared (FFT calculation), we obtain $N = 32768$, which gives $f_w = 0.61 \text{ Hz}$ resolution of the spectrum.

In some cases of the discussed protection system, the resolution of the spectrum can be reduced. Therefore, an example will also be included in which the resolution of the spectrum is $f_w = 10 \text{ Hz}$. The minimum number of samples for this assumption is equal to $N = 2000$. Here, too, it is assumed that the number of samples must be the square of 2, which gives $N = 2048$. The resolution for the number of samples is $f_w = 9.8 \text{ Hz}$.

The time delay

As can be seen on Figure 1, the key issue of the presented protection system is the turn-off time – the provision of a short period of time will permit for higher touch current.

In the presented system, the turn-off time t_o can be described as the sum of the time components:

$$(7) \quad t_o = T_w + t_p + t_b$$

where

- T_w – sampling time (the length of the time window),
- t_p – duration of the program, taking into account the calculations time (without time measurement),
- t_b – time of circuit breaker operation.

The sampling time depends on the sampling frequency f_s and the number of samples N :

$$(8) \quad T_w = \frac{N}{f_s}$$

For the considered cases (with sampling frequency $f_s = 20 \text{ kHz}$) this period is $T_w = 1638.4 \text{ ms}$ (for $N = 32768$) and $T_w = 102.4 \text{ ms}$ (for $N = 2048$).

The duration of the program takes into account the implementation of the algorithm and performed calculations, including the calculation of the Fast Fourier Transform, the designation of the components in the power spectrum and the calculation of the current replacement and comparison with the limit value.

The value of this time depends on the structure of the program. If the measurement is performed in "Finite Samples" mode, than the download of each set number of samples must be preceded by the settings regarding the measurement channel and the source and frequency of the clock signal. The task must be stopped after the measurement. This causes quite a considerable delay – on the basis of the tests, the value $t_p = 60 \text{ ms}$ can be set.

This time can be shortened after turning into "Continuous Samples" mode. In this case, the measurement is performed on a continuous basis, and after downloading the specified number of samples may perform the required calculations. This allows for a reduction of time to approximately $t_p = 1 \text{ ms}$.

The operating time t_b of the breaker is the time from the shutdown signal sent from the software to the time of effective circuit interrupt. This time depends mainly on the used contactor. It can be assumed that this time is in the range $t_b = 20...40 \text{ ms}$.

Thus, the off time is approximately $t_o = 1680 \text{ ms}$ or $t_o = 140 \text{ ms}$, depending on a certain number of samples.

For the first time (1680 ms) of these values shown in Figure 1, results the need to reduce the current to about 40 mA. In the case of shortening the time-off to the second of these limits (140 ms), the allowable current can be increased up to ten times.

Errors in calculation of the effective value

In determining the effective value of the measured current, the impact on the accuracy of the measurement time is the selection for the number of the periods measured current. For example, over the length of the time window $T_w = 102.4 \text{ ms}$, assuming that the current frequency is 25 Hz, the recorded portion of the time course of the current period, receive 2.56 (Fig.7).

The calculated effective value will differ from the true rms, calculated for the total number of periods. The error value depends on the position of the time window relative to the measured waveform. Figure 8 shows the value of the error as a function of phase of the beginning of the time window.

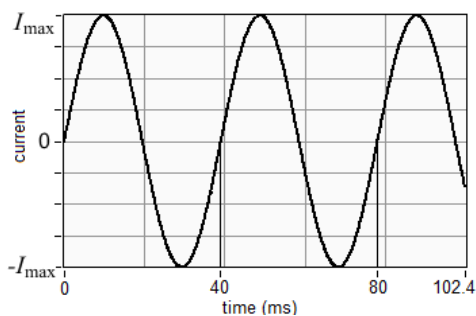

Fig.7. Registered fragment of current waveform at a frequency of 25 Hz, the time 102.4 ms

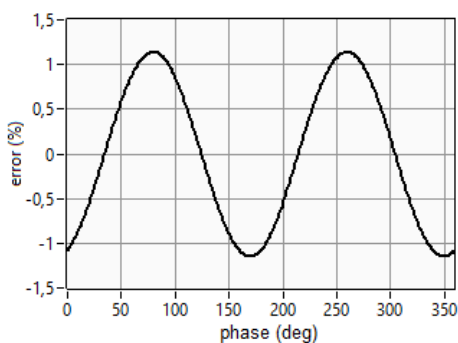

Fig.8. The error with which the effective value of the current waveform with a frequency of 25 Hz, at the time of 102.4 ms in the early phase of the function of the time window

The highest values of errors can occur at very low frequency current. At higher frequencies, the time window we have more current periods, the error will be smaller. In Figure 9, the maximum value of the error with which the effective value of the current waveform at the time of 102.4 ms as a function of the current frequency is presented.

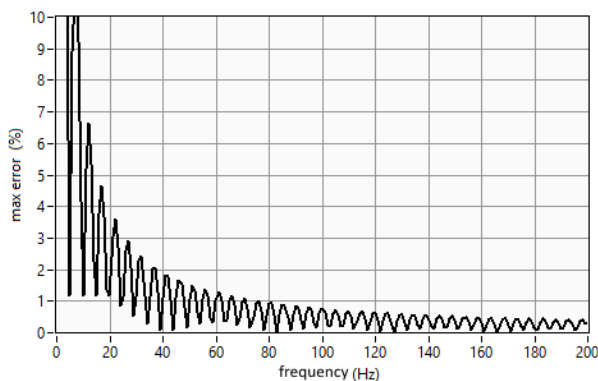

Fig.9. The maximum value of the error with which the effective value of the current waveform at the time of 102.4 ms as a function of the current frequency

The value of this error also depends on the length of the time window. With longer time measurement when we record a larger number of the current period, the error will be smaller. Figure 10 presents the maximum value of the error with which the effective value of the current waveform for the second value over the length of the time window 1638.4 ms, as a function of the current frequency.

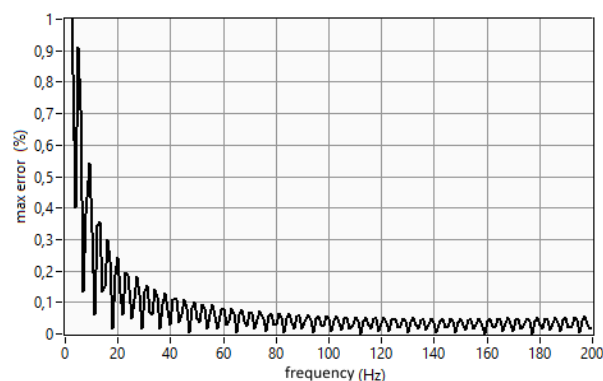

Fig.10. The maximum value of the error with which the effective value of the current waveform during 1638.4 ms as a function of the current frequency

Conclusion

A metrological analysis has been performed allowing the selection of measurement parameters: sampling frequency and number of samples taken. The restrictions are due on the one hand to increasing the range of the analyzed frequency and high-resolution spectrum, which requires a large number of samples, resulting in a long measurement time and a long time of the calculation. On the other hand, we aim to reduce this time to the time of occurrence of a hazard to the time of setting of the breaker was so short that the current operation does not jeopardize human life.

REFERENCES

- [1] Effects of current on human beings and livestock. Part 1: General aspects, IEC/TS 60479-1, (2005)
- [2] Czapp S., Guzinski J., The effect of the motor filters on earth fault current waveform in circuits with variable speed drives, *11th Conf.-Seminar Int. School on Nonsinusoidal Currents and Compensation ISNCC 2013*, Zielona Gora, Poland, 20-21 June, (2013)
- [3] Czapp S., Comparison of residual current devices tripping characteristics for selected residual current waveforms, *Elektronika ir Elektrotechnika*, (2010), n.4 (100), 7-10
- [4] Schoneck J., Nebon Y., LV protection devices and variable speed drives, *Cahier technique* n.204, Schneider Electric, (2002)
- [5] Grünebast G., Allstromsensitive Fehlerstromschutz-einrichtungen. Teil 2: Vorschriftsmässiger Einsatz, *Elektropraktiker* 62 (2008), n.2
- [6] Freschi F., High-frequency behavior of residual current devices, *IEEE Trans. on Power Delivery*, 27 (2012), n.3, 1629-1635
- [7] Czapp S., Swisulski D., Computer system for evaluation of shock hazard in circuits with non-sinusoidal earth currents, *12th Conf.-Seminar Int. School on Nonsinusoidal Currents and Compensation ISNCC 2015*, Lagow, Poland, 15-18 June, (2015)
- [8] Czapp S., Wlas M., Działanie wyłączników różnicowoprądowych przy doziemieniu silnika zasilanego z przemiennika częstotliwości, *Przegląd Elektrotechniczny*, 86 (2010), nr4, 296-301
- [9] Effects of current on human beings and livestock. Part 2: Special aspects, IEC/TS 60479-2, (2007)
- [10] Swisulski D., *Przykłady cyfrowego przetwarzania sygnałów w LabVIEW*. Wydawnictwo Politechniki Gdańskiej, Gdańsk, (2012)

Authors: dr hab. inż. Dariusz Swisulski, Politechnika Gdańska, Wydział Elektrotechniki i Automatyki, ul. Narutowicza 11/12, 80-233 Gdańsk, E-mail: dariusz.swisulski@pg.gda.pl; dr hab. inż. Stanisław Czapp, Politechnika Gdańska, Wydział Elektrotechniki i Automatyki, ul. Narutowicza 11/12, 80-233 Gdańsk, E-mail: stanislaw.czapp@pg.gda.pl