

Article

Modelling Long-Term Transition from Coal-Reliant to Low-Emission Power Grid and District Heating Systems in Poland

Marcin Jaskólski *  and Paweł Bućko 

Faculty of Electrical and Control Engineering, Gdańsk University of Technology (Gdańsk Tech), ul. Gabriela Narutowicza 11/12, 80-233 Gdańsk, Poland; pawel.bucko@pg.edu.pl

* Correspondence: marcin.jaskolski@pg.edu.pl; Tel.: +48-58-347-12-54

Abstract: Energy systems require technological changes towards climate neutrality. In Poland, where the power system is dominated by outdated coal-fired power plants, efforts to minimize the environmental impact are associated with high costs. Therefore, optimal paths for the development of the energy sector should be sought in order to achieve ambitious long-term strategic goals, while minimizing the negative impact on the consumers' home budget. A methodology and a model for the development of the electricity and heat generation structure were developed and implemented in market allocation (MARKAL) modelling framework. Two scenarios were presented, i.e., business as usual (BAU) and withdrawal from coal (WFC) scenarios. The calculations showed a significant role of nuclear energy and offshore wind power in the pursuit of climate neutrality of electricity generation. In the BAU scenario, the model proposes to stay with coal technologies using carbon capture and storage systems. Withdrawal from coal (WFC scenario) makes it necessary to replace them by gas-fired power plants with CO₂ sequestration. Solar energy can be used both in electricity and district heating. In order to build on the latter technological option, appropriate energy storage techniques must be developed. Geothermal energy is expected to be the key option for district heat generation in the long-term horizon. The proposed development paths guarantee a significant reduction in greenhouse gases and industrial emissions. However, complete climate neutrality is uncertain, given the current degree and dynamics of technological development.

Keywords: energy system planning; generation expansion planning; energy system optimization models; MARKAL; energy policy design; reference energy system; decarbonization; bottom-up model



Citation: Jaskólski, M.; Bućko, P. Modelling Long-Term Transition from Coal-Reliant to Low-Emission Power Grid and District Heating Systems in Poland. *Energies* **2021**, *14*, 8389. <https://doi.org/10.3390/en14248389>

Academic Editors: Igor Simone Stievano and Riccardo Trincherò

Received: 13 November 2021
Accepted: 10 December 2021
Published: 13 December 2021

Publisher's Note: MDPI stays neutral with regard to jurisdictional claims in published maps and institutional affiliations.



Copyright: © 2021 by the authors. Licensee MDPI, Basel, Switzerland. This article is an open access article distributed under the terms and conditions of the Creative Commons Attribution (CC BY) license (<https://creativecommons.org/licenses/by/4.0/>).

1. Introduction

This article is devoted to modelling the development of energy systems in terms of the structure of electricity and heat generation. The subject of the work is in line with the idea of sustainable development and helps to set and achieve the goals of the national energy and climate strategy. The need to reduce greenhouse gases and industrial emissions in order to improve air quality and mitigate climate change was reflected in the legal and strategic documents of the European Union. It is also stimulated by the functioning of the EU Emissions Trading System (EU ETS) [1–4]. Climate change and emission trade have a broader dimension as the ETS problem was recently addressed in studies, e.g., in China [5–7]. These policies force the use of sources that apply low- and zero-emission technologies, including those based on renewable energy resources, often with uncontrolled variability of power generation [8]. The implementation of, e.g., solar technologies is therefore a considerable challenge, as the power system operator must maintain power system stability [9] and tackle voltage issues [10]. In order to be able to balance the power systems at all times and meet energy quality standards, sources of various types of operation must be installed. A rapidly growing market of energy storage systems may constitute a promising solution, while batteries themselves may not guarantee

the stable operation of the power system, in which intermittent generation sources will prevail [11]. The growing interest in emission-free modes of transport, in particular electric vehicles, will certainly contribute to a significant increase in demand for electricity. At the same time, the demand for batteries will increase, which may limit their availability for the power industry [12]. However, other solutions can be available, such as the conversion of electricity to hydrogen and its subsequent use, e.g., in fuel cells [13].

The need to use indigenous renewable energy resources and reduce losses in energy supply systems requires the transformation of these systems from a traditional centralized to decentralized structure, planned and coordinated at the local level. However, the total transformation to decentralized systems may not materialize by the middle of this century due to the limitations in technological progress in the field of energy storage and energy management systems, as well as the relatively low energy awareness and activity in the field of energy production in society.

Power systems developed dynamically in the 1960s and 1970s. Initially, they were based mainly on fossil fuels. Currently, many of these systems require modernization, especially in terms of the structure of electricity generation. A similar issue concerns district heating systems. In Poland for instance, heating plants and coal-fired combined heat and power (CHP) plants still dominate. As of the end of 2020, electric installed capacity in Poland was 49.1 GW, of which 46.01% was installed in coal-fired and 17.15% in lignite-fueled utility (public) power plants, the share of gas-based utility power plants was 5.63%, the contribution of industrial autoproducing CHP plants (of which many are still fired with hard coal) was 5.76%, the utility hydro plants share was 4.77%, while wind farms and other renewables share was 20.69% [14]. The domination of coal is even more visible when analyzing annual gross domestic electricity generation. The latter amounted to 152.3 TWh/a in 2020, which was lower than in preceding years, i.e., 158.8 TWh/a in 2019, and 165.2 TWh/a in 2018 [14]. The 2020 shares in total gross domestic annual electricity production were [14]: hard-coal-fired utility power plants—46.97%, lignite-fired utility power plants—24.93%, gas-fueled utility power plants—9.14%, industrial autoproducing CHP plants—6.43%, utility hydro plants—1.77%, wind and other renewables—10.75%. District heat production (not including heat for industrial or commercial processes) totaled 285 PJ/a in 2020, of which public thermal plants (CHP plants and turbines installed in thermal power plants) generated 60%, public heating plants 21%, heat-only boilers in public thermal plants 12%, autoproducing CHP plants 6%, and non-public heating plants 1% [15].

The necessity to change the method of generating and supplying energy to end users creates an opportunity to build an energy system that is environmentally friendly. Past studies [16] indicated that rebuilding a power system based on fossil fuels is also associated with high electricity generation costs. Relying on zero- and low-emission sources is also a financial challenge, but it is worth considering in order to reduce the external costs of energy generation, including the costs of deteriorating health and loss of human life resulting from a polluted environment.

Bearing in mind the above considerations, the authors seek answers to the following questions: (1) How to ensure electricity supply in response to the growing demand in the face of the development of the electric vehicle market? (2) What is an optimal choice of technologies to meet the renewable energy share goals? (3) Should the electricity generation structure completely change from highly centralized to decentralized? (4) What impact will greenhouse gas emission allowance trading schemes have on the choice of electricity and heat generation technologies? (5) When and under what economic conditions will it be justified to build a nuclear power plant? (6) What role should coal play in the transformation of the electricity sector? (7) Is it possible to build a climate-neutral energy system or under what conditions is it feasible?

In order to obtain answers to the above questions, authors developed a methodology that builds on existing modelling frameworks for energy systems optimization, but takes into account modern technologies and market mechanisms. The main area of interest of

this work is generation expansion planning of energy systems, where the supply of carriers takes place through power and heating networks, taking into account distributed energy sources and energy microgrids. Their development will be studied in the long term, i.e., until 2060. The modelling methodology is intended to be a tool supporting decisions in the field of investment planning of energy facilities. These investments are expected to lead to the building of sustainable energy systems, so that the existing fossil fuel resources can serve the needs of future generations, not only in terms of energy supply, but also in the production of other goods.

Simultaneous consideration of all long-term energy policy objectives when planning optimal energy systems is a complex process. The databases on energy systems are impossible to handle without computer help. Therefore the use of supporting tools is recommended and the development of models is an important scientific and engineering problem. The most commonly used modelling frameworks are: market allocation (MARKAL), energy flow optimization model (EFOM), model for energy supply system alternatives and their general environmental impacts (MESSAGE), the integrated MARKAL-EFOM system (TIMES), and open source energy modelling system (OSeMOSYS).

The use of energy modelling tools to address generation expansion planning dilemmas was a subject of the previous scientific work. Dagoumas and Koltsaklis [17] discussed generation expansion planning tools with special emphasis on renewable energy sources integration. Gaur et al. [18] went further in their analyses by means of using a unit commitment module to incorporate short-term operational constraints in energy system planning. Yu et al. [19] analyzed air pollutant reduction paths for China using the integrated MARKAL EFOM system (TIMES). Sarica and Tyner [20] used the MARKAL-MACRO model to study the effect of increased US natural gas imports on the energy system. OSeMOSYS was employed to address the problem of balancing high shares of variable renewables through the use of flexible power generation [21] and to build a global energy system model [22]. One of the tool extensions is OSeMOSYS-PuLP [23] which handles large real-world data sets and incorporates Monte Carlo simulations. Most recent analyses on Polish energy system optimal development involve the contribution of Kaszyński and Kamiński [23], who studied demand for hard coal and brown coal in a long-term perspective (by 2050) in view of the current environmental regulations.

Research presented in this paper contributes in many ways to the scientific debate on energy system development, specifically in Polish conditions characterized by a high share of coal-based electricity and heat. Relative to previous work by the authors [16,24–28] and published literature discussed above, this article: (1) presents the method of modelling carbon capture and storage (CCS) technologies; (2) updates datasets used; (3) adds new technological options to the model, e.g., battery energy storage systems; (4) explains the model of EU ETS based on step-wise supply curve for emission allowances; (5) presents new electricity and heat demand projections based on the dynamics of macroeconomic parameters and taking into account dynamic development of the electric car market; and (6) extends the planning horizon to the year 2060.

This article is structured as follows: Section 2 demonstrates the modelling tool used, reference energy system (RES) description, and datasets used. Section 3 summarizes the results, while Section 4 provides discussion of the most important outcomes. Concise conclusions are drawn in Section 5. In Appendix A, detailed results of the analysis are presented, whereas Appendix B describes the MARKAL modelling framework.

2. Materials and Methods

This chapter describes the assumptions and methodology for modelling the development of sustainable energy systems in Poland. The model allows for the optimization of the production structure of energy carriers corresponding to these systems. It includes the production of electricity and network heat from commercial energy sources, i.e., system power plants, combined heat and power plants, and heating companies, supplemented



with generation of energy from distributed generation sources, i.e., independent power plants and renewable energy sources, as well as microgeneration.

This model searches for a technology structure that meets the optimization criterion, limited by linear constraints that reflect the functioning of energy systems and the assumptions of national and European energy policy. The main results are the technological structure of net attainable power (capacity), annual net electricity and heat generation, and the amount of emissions. The tool the model is implemented in is MARKET ALlocation (MARKAL) [29], described in Appendix B. The model implemented in this tool allows, inter alia, the inclusion of the EU Emissions Trading System (ETS, EU ETS). The mapping of carbon dioxide capture and storage (CCS) technology is proposed.

2.1. Reference Energy System (RES)

The energy system is understood as a network of interconnections of energy resources in various forms with end users through a set of energy technologies. In the described model, the structure of connections between the flows of individual energy carriers and the corresponding technologies is called the reference energy system (RES). This takes into account data availability constraints and the planning horizon. In the models based on the RES concept, the network infrastructure is presented in a simplified manner. The power system and district heating systems are represented by busbars. They are assigned unit variable operating costs and unit investment expenditure, related to the installed capacity in new production technologies, the construction of which is proposed by the optimization procedure. The model user also determines the efficiency of these systems, taking into account transmission and distribution losses. Connections between power grids, e.g., power stations, are mapped. Electricity imports and exports represent trans-boundary power system connections. The RES diagram for the power infrastructure is shown in Figure 1, and for district heating systems it is presented in Figure 2.

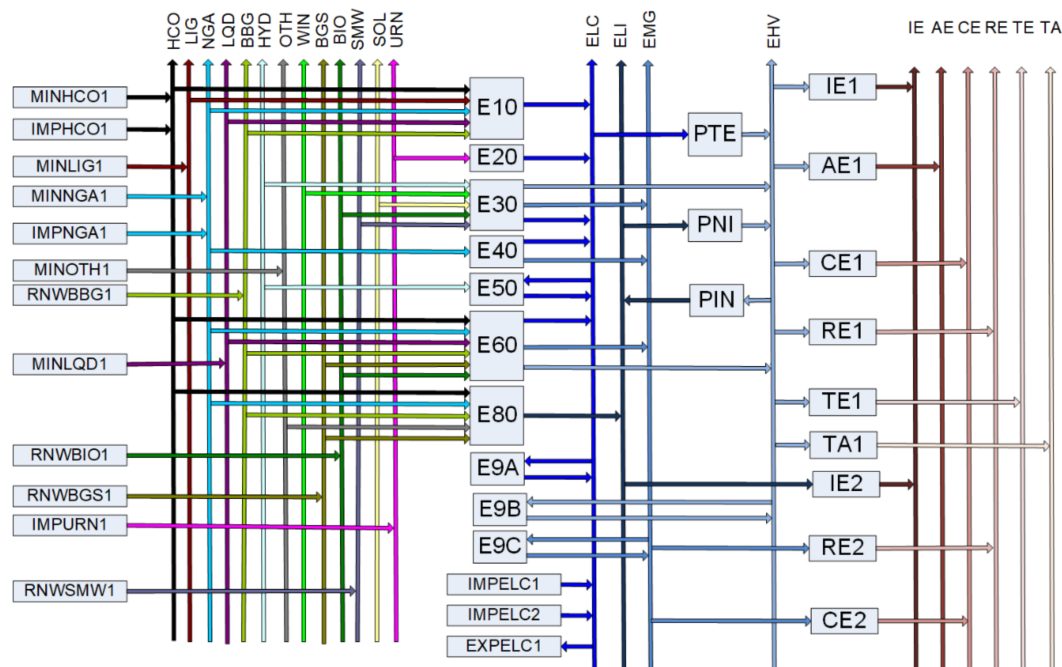

Figure 1. Reference energy system representation of the power grid (own study). Note: demand categories (each category has at least one corresponding demand technology, e.g., IE1)—final electricity in respective economy sectors (and subcategories): IE—industry, AE—agriculture, CE—commercial, RE—residential, TE—transport (excluding electric cars), TA—transport (electric cars); energy carriers: HCO—hard coal, LIG—lignite, NGA—natural gas, OTH—other fuels, BIO—biomass, BGS—biogas, BGG—biomass and biogas (existing plants), HYD—hydro energy, WIN—wind energy, LQD—liquid, URN—nuclear fuel, SOL—solar energy, GEO—geothermal energy, SMW—solid municipal waste; electrical

grids: ELC—transmission public, ELI—industrial autoproduction (separated from public), EMG—microgrids, EHV—distribution public; conversion technologies: power substations: PTE—highest voltages (400 kV, 220 kV)/high voltages (110 kV) substations, PIN/PNI—substations' connection of industrial autoproduction plants with public grid (in both directions); generator technology categories: E10—public coal- and lignite-fired thermal plants, E20—public nuclear plants, E30—independent renewable, E40—public gas plants, E50—public hydro and pumped-storage plants, E60—public and independent combined heat and power (CHP) plants, E80—industrial autoproduction CHP plants, storages: E9A, E9B, E9C—battery storages; resources/transboundary flows: IMPELC1, IMPELC2, EXPELC1—imports and exports of electricity, MINHCO1, IMPHCO1—domestic mining and imports of hard coal, MINLIG1—lignite mining, MINNGA1, IMPNGA1—domestic extraction and imports of natural gas, MINOTH1—extraction of other fuels (“dummy” category for existing plants), RNWBIO1, RNWBSG1, RNWBGG1—extraction of biomass and biogas (the latter is a “dummy” category), IMPURN1—nuclear fuel imports, RNWSMW1—domestic acquisition of solid municipal waste.

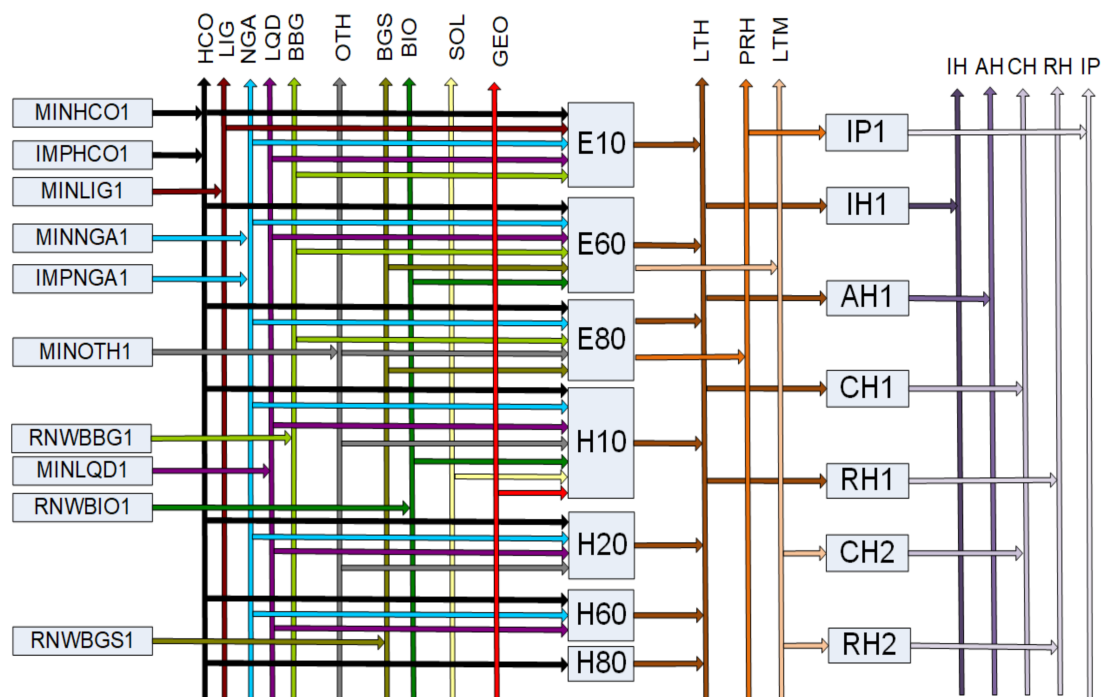

Figure 2. Diagram of the reference energy system for district heating systems (own elaboration). Note: demand category (each having at least one corresponding demand technology denoted, e.g., IH1): low-temperature heat demands in respective economy sectors, i.e., IH—industrial, AH—agriculture, CH—commercial, RH—residential; process heat demand in economy sector i.e., IP—industry; heating plants: H10—public heating plants, H20—private/independent heating plants, H60—heating boilers in power plants and combined heat and power plants, public, independent, and owned by heating companies, H80—heating boilers in industrial autoproduction CHP plants; remaining denotations as in Figure 1.

2.2. Modelling Emission Trading Schemes (ETS)

To reflect European Union Emission Trading Scheme (EU ETS) in the MARKAL model, sets of elements representing the type of emissions (in MARKAL marked as ENV—environmental indicator) were created, which distinguish CO₂ emissions from installations participating in the EU ETS from those outside the ETS (non-ETS). Then, subsets were created reflecting the emissions from various types of installations participating in the EU ETS, mainly due to the division of installations in the plans of free allocation of emission allowances in the first three trading periods.

The EU ETS group includes technologies for which the typically thermal power supplied in the fuel is higher than 20 MW [2]. At the same time, installations using renewable fuels and those with thermal power in fuel below 20 MW belong to the non-ETS group. The MARKAL model, based on information entered by the user (including emission indicators) and the values of variables representing energy production, calculates the

amount of emissions from particular types of technologies. The emissions are constrained in two ways. Firstly, by the number of allowances granted for free (only until 2015 of the model, covering the years 2015–2019), and secondly, by the number of allowances available on the EU ETS market—from the model year 2010 (2010–2014) onwards. The second constraint, however, should additionally take into account the share of allowances available to energy entities covered by the MARKAL model—i.e., power plants, combined heat and power plants, and heating plants in Poland, which in turn would require the inclusion of other EU ETS participants in the model. In the 2010 modelling period, the emission limit was set at the national level, while in the periods 2015–2060—at the level of the entire EU ETS. If the emissions of a given group of installations exceed the limit of free allowances, that group has to buy them at auctions or from other participants in the EU ETS. If the national or European limit of available allowances is exceeded, participants who fail to surrender sufficient number of EUA are fined.

The EU ETS model works as follows. Each electricity- or heat- or both-generating technology in which installations covered by the EU ETS are located, were assigned, apart from the standard CO₂ indicator, an emission equivalent (TC1-TC8), depending on whether they belong to the group of producers, described in Figure 3. One EU emission allowance (1 EUA) is required for each emission unit (1 t). Some of these allowances were allocated to power plants for free, but only until the end of the third trading period in the EU ETS (years 2013–2020). The remaining part must be purchased at auctions that are mapped in the model using the IMPT(X)C(Y) purchase option, where X is replaced by a number from 1 to 8 representing a group of producers, and Y is a number from 1 to 5 representing the allowance price level in a given planning subperiod. The sale of allowances is mapped by the export of goods EXP(X)TC1 and only one price level is assumed here. The selling price must be lower than the lowest purchase price of the allowance in order to avoid the problem of finding the optimal value of the objective function. The minimization of the system costs would then lead to the maximization of exports, which, in the absence of a boundary on the quantity of exported goods, would make the optimization problem unsolvable. The number of allowances granted for free to a given group of producers and the number of allowances available at a given price are limited by equations using the ad hoc relationships (ADRATIO) IMPT(1–8)C(1–5) and EXPT(1–8) C1, which are constraints imposed on the variables representing the quantities of commodities being CO₂ equivalents. Such a mapping of the auction mechanism is a simplification aimed at taking into account the fact that, apart from Polish power plants, combined heat and power plants, and heating plants, there are other participants of the EU ETS, not only in other sectors of the economy, but also in other countries participating in the system.

Allocations of free allowances, made possible in the first three trading periods of the EU ETS, were taken into account as emission limits; if exceeded, emission allowances must be purchased at auctions. In the first two settlement periods, the sum of the allowances granted was the national emission limit. From the third settlement period, the emission limit was established for the entire EU ETS (ETS cap). As its value after the fourth trading period (years 2021–2030) is not known, it can only be forecast on the basis of the reduction targets proposed in the EU's energy policy until 2030 [30] and the decarbonization strategy included in the Energy Roadmap to 2050 [3]. It is a separate issue as to what part of the pool of allowances will be available for purchase by Polish entities. Allowance price forecasts have been linked to the number of allowances available in the EU ETS. Five price levels were proposed for each planning horizon and it was determined what share of the entire allowance pool would be available at that price.

Another method, much more labor-intensive, but allowing for more detailed analysis, is the construction of a multi-regional model, in which Poland would be one of them. This task, however, goes beyond the research presented in this article. The reference energy system for the EU ETS is presented in Figure 3.



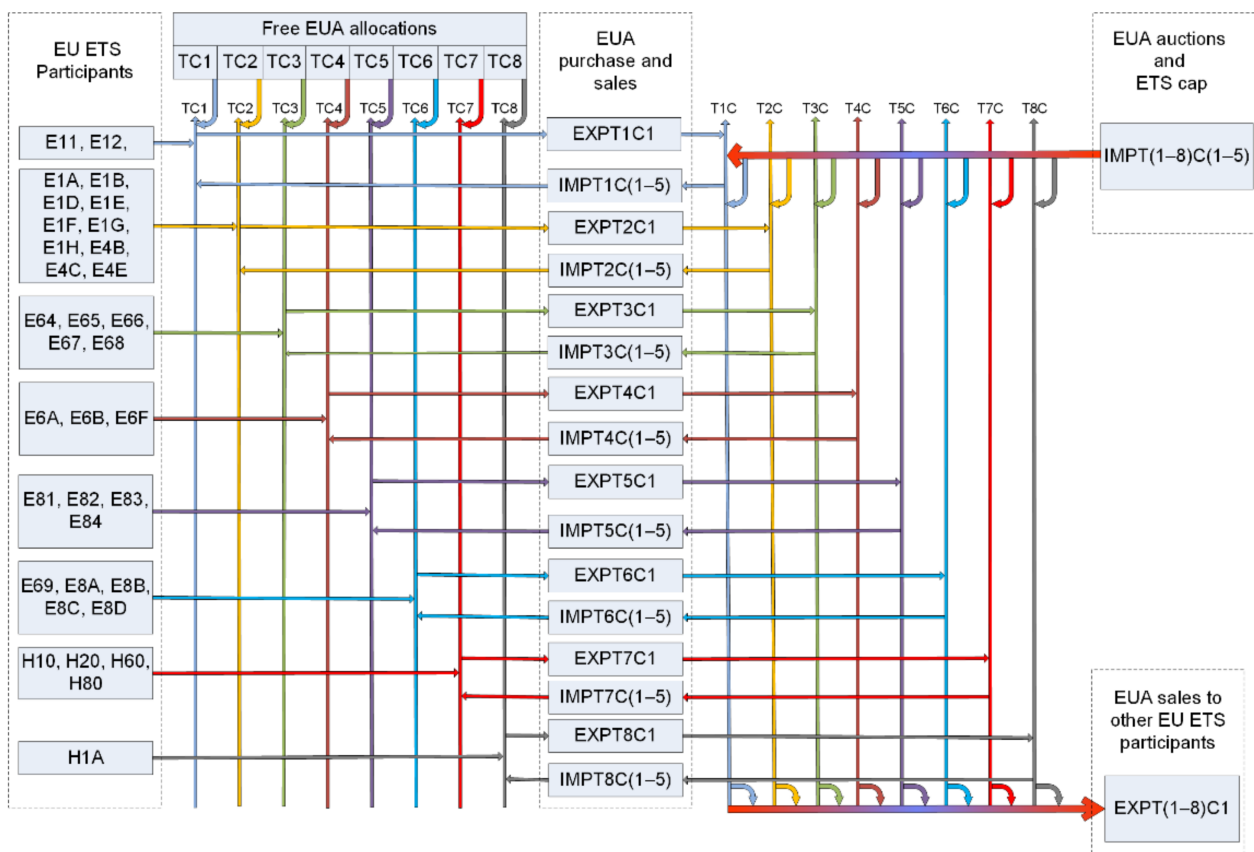

Figure 3. Model structure for European Union Emission Trading Scheme (EU ETS) (own elaboration). Note: TC1–TC8—emission equivalents (environmental indicators): TC1—utility (public) PP—existing, TC2—utility (public) PP—new, TC3—utility (district heating) CHP—existing, TC4—utility (district heating) CHP—new, TC5—industrial autoproduction CHP—existing, TC6—industrial autoproduction CHP—new, TC7—utility DHP—existing, TC8—utility DHP—new; T1C–T8C—corresponding EUA equivalents (energy carriers); IMPT(X)C(Y)—purchase option of EUA, EXP(X)TC1—sales option of EUA.

2.3. Modelling Carbon Capture and Storage (CCS)

In the face of the decarbonization of the energy sector in the EU, CCS technologies are the only chance to preserve coal technologies. They were left in this model to support the decision on whether to leave coal-fired power plants in the power system, e.g., in the case of an absence of other affordable options. The CCS systems have been included in the model by means of a set of technologies and energy carriers (commodities) described in the RES fragment, presented in Figure 4.

The names of energy carriers that allow one to track the sequestration process are written vertically, and the names of emission factors horizontally (The MARKAL model enables processes in which only energy carriers are the input commodities, hence the use of the so-called tracking carriers). Technologies using CCS have been defined in the RES of the MARKAL model, taking into account additional capital expenditure and operating costs as well as lowering the efficiency of electricity generation due to CO₂ capture from flue gas or its separation before gasification [31–33]. Each of the technologies belonging to the group of power plants equipped with a system to separate carbon dioxide (CCS_ELE) was assigned the CCS emission factor—which is the equivalent of the captured amount of CO₂ emissions, the TC2 emission factor—which is the equivalent of the emitted CO₂ (assuming separation efficiency of 90% [33,34]), and the carrier energy CCSOUT tracks the amount of CO₂ captured from the power plant. Subsequently, the CCSOUT tracking medium is the input of the TRNCCS process, which maps the liquefaction (condensation) and transport of liquid CO₂ through pipelines to the place of permanent deposit. The output carrier is

CCSSTR which is the equivalent of CO₂ delivered to the storage site. The next step is to map the injection using the SALAQU, HYDFLD, and CBMCOA processes, the output carriers of which are CO₂ equivalents stored in saline aquifers (CCSAQU), hydrocarbon deposits (CCSHYD), and carbon seams, or by injection with methane recovery from coal beds (CCSCBM). The respective processes EXPCCSAQU1, EXPCCSHYD1, and EXPCCSCBM1 represent the final deposition of CO₂ and have a cumulative limit corresponding to the storage potential of CO₂ determined on the basis of [35].

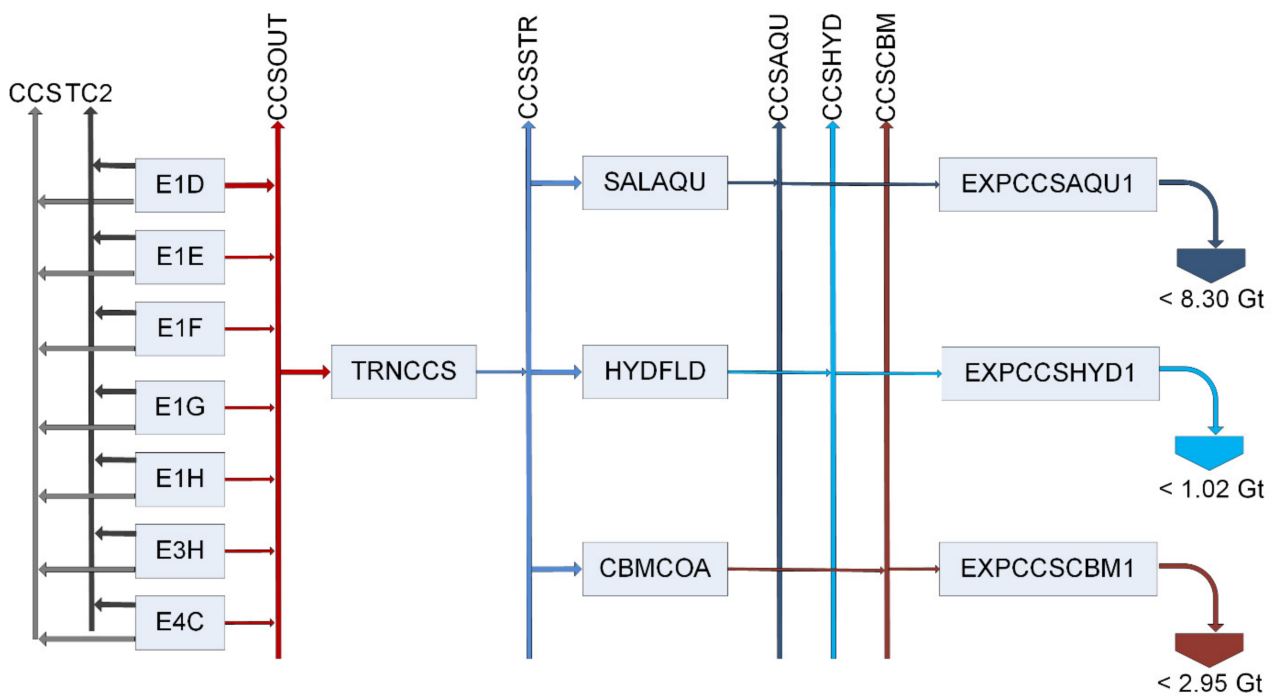

Figure 4. Model structure for carbon capture and storage (CCS) (own study). Note: E1E–E1H—coal-based technologies with CCS, E3H—biomass-based technology with CCS, E4C—gas-fueled technology with CCS, CCSOUT—energy carrier tracking CO₂ captured in power plants, TC2—CO₂ emissions from power plants covered by the EU ETS, CCSTRN—CO₂ tracking medium transported to the permanent deposition site, CCSAQU, CCSHYD, CCSCBM—CO₂ tracking media stored in saline aquifers (AQU), hydrocarbon fields (HYD) and coal seams or by injection with coal bed methane recovery (CBM), TRNCCS—CO₂ transport process from a power plant to a deposit site, SALAQU, HYDFLD, CBMCOA—processes mapping CO₂ storage, EXPCCSAQU1, EXPCCSHYD1, EXPCCSCBM1—technologies denoting the permanent deposition of CO₂ in appropriate deposits.

2.4. Datasets

The time horizon of the analysis was divided into five-year periods. The introduced assumptions and the results of the solution to the optimization problem, e.g., energy production and emissions, are appropriate for the period of one year, but at the same time are equal in the entire five-year period of time. This is a kind of simplification that is allowed in long-term planning analyses due to the uncertainty of the input data and the need to shorten the calculation time of the model. The first period of the model analysis, called the base year, lasts from 2010 to 2014, for which the data on the condition of the energy sector from 2014 are representative. In the MARKAL model, this period is designated as its first year (2010). This is a period of time that is entirely relevant to the past and for which historical data have been provided. The period 2015 (2015–2019) is the calibrating period—the model computes variable values and proposes new capacity additions, where actual investment has taken place, while capacities and annual generations are constrained by historic data from this period. The planning time horizon ends in 2060 (2060–2064).

The division of the year was made by assigning the full months of the seasons to particular model seasons. Winter covers the months of January–March, spring and autumn

(transition season)—April–June and October–December, while summer—July–September. The times of the day (day and night) were selected so that they were equal in all seasons. The day covers the hours from 8.00 am to 7.59 pm, and the night—from 8.00 pm to 7.59 am. The discount rate in the model was set for the entire system at 10%, but energy technologies have individually set discount rates.

Representations of existing power plants and new electricity generation technologies have been drawn up separately. The forecast of changes in the net capacity of the existing power plants and combined heat and power plants was made on the basis of the power transmission system development plan until 2025 [36] and the data contained in the catalogs of public power plants and combined heat and power plants [37] and industrial combined heat and power plants [38]. Data on investments in 2014–2021 were verified on the basis of information on generation resources in the National Power System (NPS) [39]. The operating period of the power unit was determined on the basis of the year of installation and information on the modernization completed. The forecast of changes in electric power is available in the existing utility thermal power plants as well as utility and industrial heat and power plants.

Table 1 presents the technical and economic characteristics of the electricity generation technologies. The forecast of trends in changes in cost indicators was made on the basis of [40]. Discount rates for individual generation technologies were selected on the basis of available studies [41,42].

Table 1. Technical and economic characteristics for new electricity generation technologies used in the MARKAL model. Own study based on the data from: [31,32,40–46]. Note: r, t, p —sets: region, time period, and technology, respectively; t_{start} —first model year technology becomes available; $\lambda_{r,p}$ —technical lifetime; n_s —availability factor; $\eta_{e(r,t,p)}$ —net electrical efficiency; $k_{n(r,t,p)}$ —specific investment cost; $k_{es(r,t,p)}$ —specific operation and maintenance (O&M) cost; u_s —capacity utilization at peak power system load; δ_p —power to heat ratio; $d_{r,p}$ —technology-specific discount rate; $eCO_{2(r,t,p)}$ —emission of CO₂ per unit of generated electricity; PP—power plant, CHP—combined heat and power plant; SC—supercritical; PCC—pulverized coal combustion; IGCC—integrated gasification combined cycle; CCS—carbon capture and storage; FBC—fluidized bed combustion; CCGT—combined cycle gas turbine, PWR—pressurized water reactor; ORC—organic Rankine cycle; NA—not applicable.

Technology Name and Symbol	t_{start} -	$\lambda_{r,p}$ a	n_s %	$\eta_{e(r,t,p)}$ %		$k_{n(r,t,p)}$ €/kW		$k_{es(r,t,p)}$ €/kW/a	u_s -	δ_p -	$d_{r,p}$ -	$eCO_{2(r,t,p)}$ kg/GJ		
				2010	2060	2010	2060					2010	2060	
Thermal PP—hard coal (SC PCC/FBC)	E1A	2015	50	90%	43%	53%	1589	1589	46.8	1.00	NA	0.10	216	175
Thermal PP—lignite (SC PCC/FBC)	E1B	2010	50	90%	43%	53%	2221	2221	46.8	1.00	NA	0.10	260	211
Thermal PP—hard coal (SC IGCC CCS)	E1D	2025	35	90%	32%	42%	3780	2681	99.1	1.00	NA	0.17	76	58
Thermal PP—hard coal (SC PCC CCS)	E1E	2025	50	90%	32%	42%	3600	2553	84.2	1.00	NA	0.17	29	22
Thermal PP—lignite (SC PCC CCS)	E1F	2025	50	90%	32%	42%	3291	2857	84.2	1.00	NA	0.17	26	21
Thermal PP—lignite (SC FBC CCS)	E1G	2025	50	90%	32%	42%	5687	4937	84.2	1.00	NA	0.17	26	21
Thermal PP—lignite (SC IGCC CCS)	E1H	2025	35	90%	32%	42%	5867	5093	99.1	1.00	NA	0.17	26	21
Nuclear PWR generation III/III+	E2A	2030	60	83%	33%	38%	4500	3949	117.0	1.00	NA	0.13	0	0
Wind farms—inland	E3A	2010	25	*	100%	100%	1300	1150	33.5	0.35	NA	0.10	0	0
Wind farms—offshore	E3B	2020	25	**	100%	100%	4500	2829	90.5	0.47	NA	0.14	0	0
Solar farms—PV	E3C	2015	25	***	100%	100%	2000	788	17.9	0.00	NA	0.09	0	0
Microgeneration –PV	E3D	2015	20	***	100%	100%	3240	2598	62.4	1.00	NA	0.13	0	0
Thermal PP—biomass (IGCC GTCC)	E3E	2020	35	83%	58%	58%	3240	3118	26.5	1.00	NA	0.13	0	0
Thermal PP—biomass (IGCC CCS)	E3F	2030	35	83%	34%	34%	3888	3118	99.1	1.00	NA	0.13	0	0

Table 1. Cont.

Technology Name and Symbol	t_{start} -	$\lambda_{r,p}$ a	n_s %	$\eta_{e(r,t,p)}$ %		$k_{n(r,t,p)}$ €/kW		$k_{es(r,t,p)}$ €/kW/a	u_s -	$\mathbf{6P}$ -	$d_{r,p}$ -	$eCO_{2(r,t,p)}$ kg/GJ		
				2010	2060	2010	2060					2010	2060	
Thermal PP—biomass (IGCC)	E3G	2025	35	83%	44%	44%	3240	2598	35.1	1.00	NA	0.13	0	0
Distributed generation—gas engine—biogas	E3H	2015	25	57%	30%	30%	2340	2340	85.0	1.00	NA	0.10	0	0
PP—CCGT—municipal waste	E3J	2015	30	65%	50%	50%	6630	4630	241.8	1.00	NA	0.10	0	0
Intervention units—gas turbines	E4A	2015	35	100%	40%	40%	390	390	15.6	1.00	NA	0.09	138	138
Thermal PP—natural gas (GTCC)	E4B	2015	40	83%	55%	61%	898	778	19.5	1.00	NA	0.09	100	90
Thermal PP—natural gas (GTCC CCS)	E4C	2025	35	83%	53%	53%	2200	1811	35.1	1.00	NA	0.17	10	10
Distributed generation—fuel cells—natural gas	E4E	2020	25	50%	40%	22%	4680	1950	87.4	1.00	NA	0.15	143	143
CHP district heating—hard coal	E6A	2015	40	44%	23%	40%	2317	2317	33.5	0.50	0.40	0.10	407	407
CHP district heating—natural gas	E6B	2015	35	67%	27%	27%	1014	1014	30.4	0.50	0.51	0.09	296	296
CHP district heating—biomass ORC	E6C	2015	30	55%	22%	22%	3151	2894	118.6	0.50	0.40	0.13	0	0
CHP district heating—biogas	E6D	2015	25	46%	35%	35%	7742	6255	88.9	0.50	0.90	0.10	0	0
Small-scale CHP—fuel cells—natural gas	E6E	2020	20	90%	49%	49%	4000	3728	87.4	1.00	2.46	0.15	116	116
Microcogeneration—gas microturbine ($p < 120$ kW)	E6F	2015	25	70%	33%	33%	4000	3118	19.5	0.50	0.70	0.09	242	242
CHP district heating—municipal waste	E6G	2015	25	80%	23%	23%	9999	6000	500	1.00	0.45	0.06	0	0
Industrial CHP—hard coal	E8A	2015	40	44%	23%	23%	2317	2317	33.5	0.50	0.40	0.10	407	407
Industrial CHP—natural gas	E8B	2015	40	67%	27%	27%	1014	1014	30.4	0.50	0.51	0.10	296	296
Industrial CHP—biomass	E8C	2015	40	55%	22%	22%	3151	2894	118.6	0.50	0.40	0.10	0	0
Industrial CHP—biogas	E8D	2015	40	46%	35%	35%	7742	5885	88.9	0.50	0.90	0.10	0	0
Energy storage (battery)—transmission grid	E9A	2020	15	25%	70%	70%	1650	1650	16.5	1.00	NA	0.10	0	0
Energy storage (battery)—distribution grid	E9B	2020	10	25%	75%	75%	2360	2360	16.1	1.00	NA	0.10	0	0
Energy storage (battery)—microgrids	E9C	2020	10	25%	80%	80%	2750	2750	11.2	1.00	NA	0.10	0	0

* Capacity utilization variability for inland wind farms: spring/autumn-day: 0.24; spring/autumn-night: 0.22; summer-day: 0.18; summer-night: 0.15; winter-day: 0.34; winter-night: 0.33; own computation based on [46]. ** Capacity utilization variability for offshore wind farms: spring/autumn-day: 0.38; spring/autumn-night: 0.37; summer-day: 0.31; summer-night: 0.30; winter-day: 0.45; winter-night: 0.45; own computation based on [46]. *** Capacity utilization variability for solar PV systems: spring/autumn-day: 0.18; spring/autumn-night: 0.03; summer-day: 0.25; summer-night: 0.04; winter-day: 0.12; winter-night: 0.01; own computation based on the data from [46].

Figure 5 illustrates the current and forecast fuel prices, including delivery costs, calculated on the basis of the data from [40,43,47].

Figure 6 presents weighted average price of emission allowances. It was obtained on the basis of step-wise supply curves of EUA.

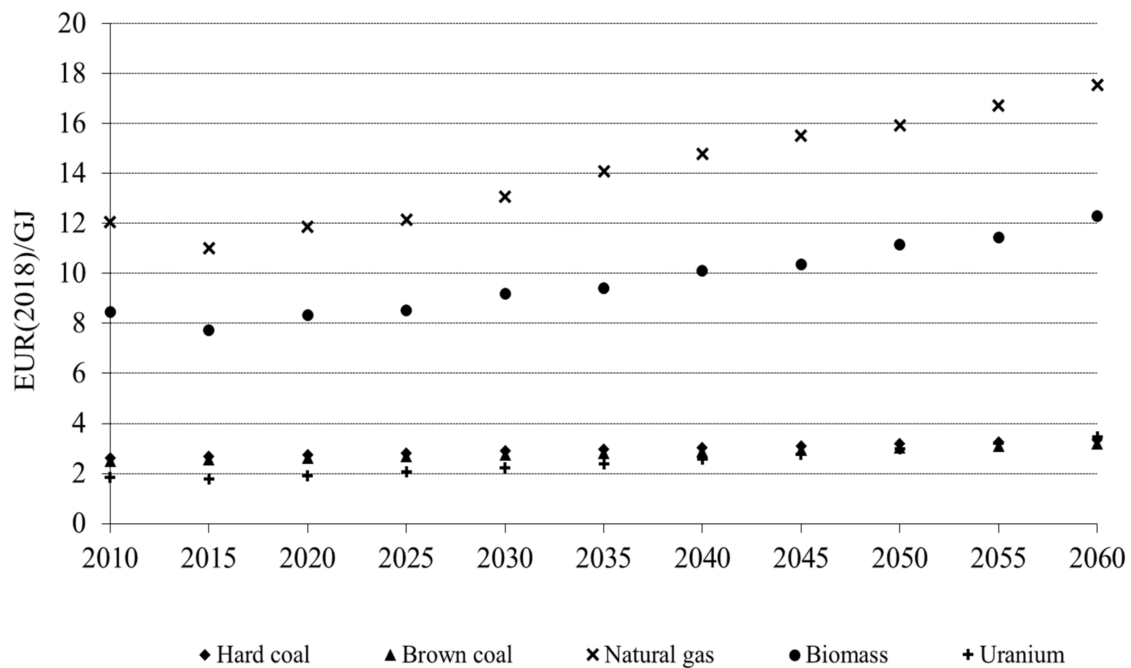

Figure 5. Fuel price forecasts until 2060, own study based on the data from [40,43,47].

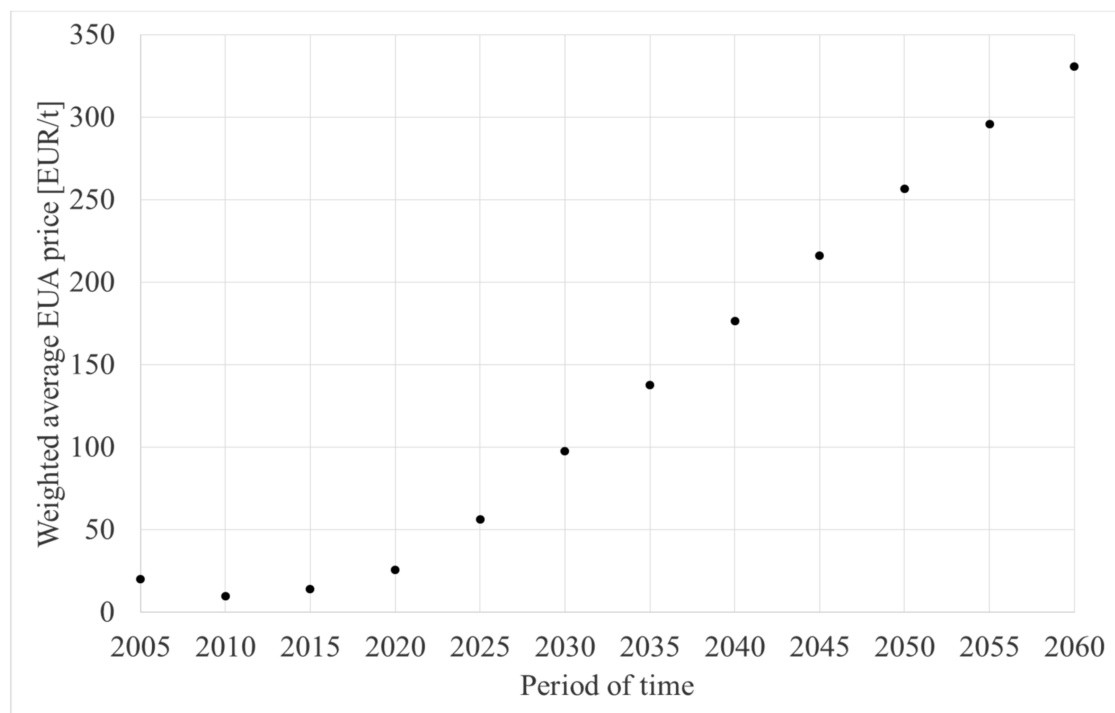

Figure 6. Weighted average of forecast EUA prices (own study based on the data from [40,48,49]).

Forecasts of electricity and heat demand at end users were also prepared. Analysts use various approaches to this problem, from the simplest—based on linear increment—to the more complex one, programmed in models specially adapted for this purpose, i.e., MAED. The authors used an approach that is partly based on the methodology of the MAED model. It was aimed at generating electricity and heat demand paths in various sectors of the economy, taking into account different types of sources in sectors, e.g., industrial heat and power plants in the industrial sector, also due to the need to make



sectoral demand dependent on various macroeconomic factors or taking into account sectoral trends in changes in demand. The demand or the dynamics of the variability of the demand for final electric energy in the relevant sector of the economy was calculated as a dependent variable of multiple regression. In the case of heat demand, due to difficulties in determining the correlation between demand and economic factors, multiple regression was not applied. The dynamics of changes in demand were based on the extrapolation of trends of changes from the past (2006–2016) in individual subsectors. The independent variables of the regression equation were chosen by the authors of the article. They are quantities having a potential impact on the volatility of demand for final electricity or heat in the economy sector. Forecasts of the volatility of the values of these variables in the considered time horizon were prepared by the authors on the basis of functions describing the volatility trend based on data from the past, taken from the databases of Statistics Poland (GUS) [50,51]. It was assumed that by 2060 the share of electric passenger cars would be 100% and trucks 60%. Electricity demand forecasts are presented in Figure 7, and heat demand forecasts in Figure 8. Despite the measures leading to the efficiency improvement of the final electricity use, the value of the latter increases to 350 TWh/a by 2060, which is mainly the result of the growing market of electric vehicles of all kinds, specifically passenger cars and trucks. For comparison, Energy Policy of Poland to 2040 (PEP2040) [52] assumes that in 2040 the final demand for electricity will amount to 192 TWh/a, and the final demand for district heat will be 214,870 TJ/a.

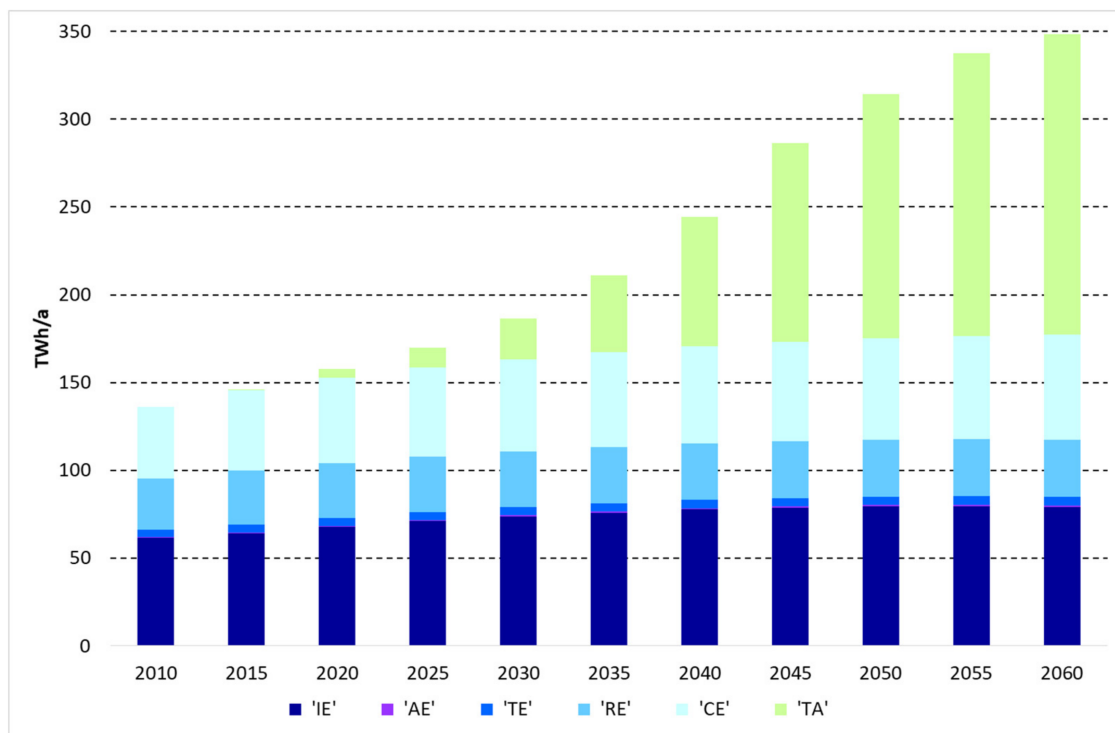

Figure 7. Forecasts of the final electricity demand (own study based on the data from [50,51]). Note: IE—industry, AE—agriculture, TE—transport (excl. electric cars), RE—residential, CE—commercial, TA—transport (electric cars).



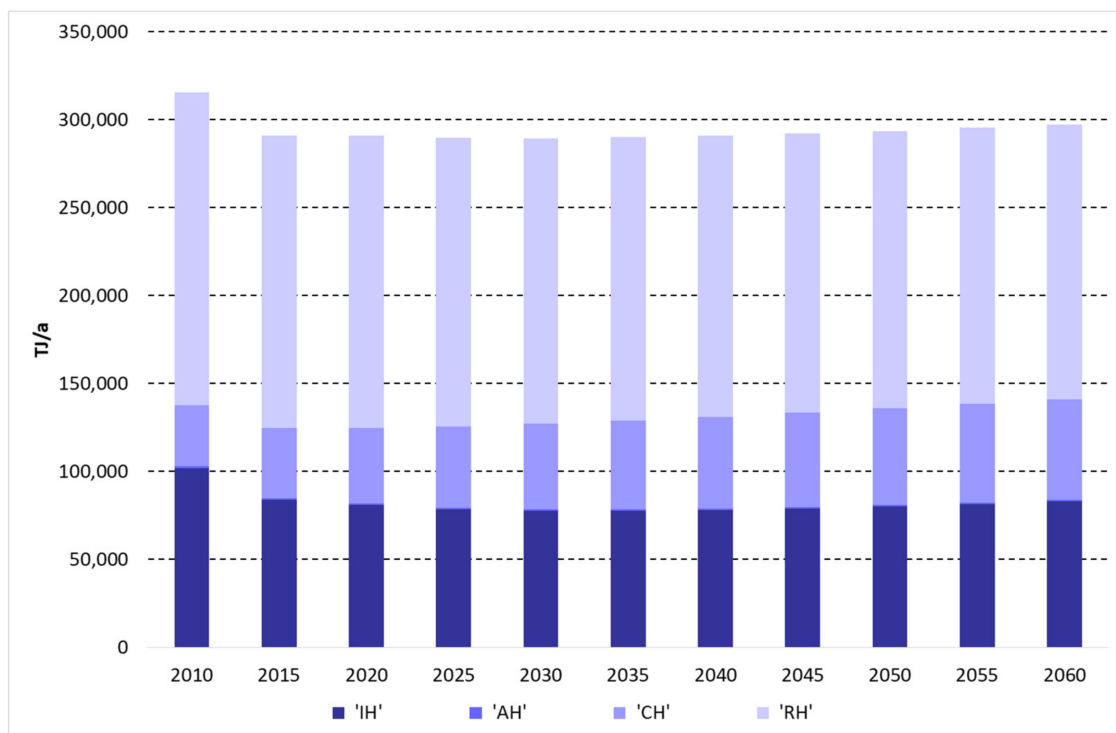

Figure 8. Forecasts of the final demand for district heat (own study based on the data from [50,51]). Note: IH—industrial, AH—agriculture, CH—commercial, RH—residential.

3. Results

3.1. Electricity Generation and Installed Capacity

3.1.1. BAU (Business as Usual) Variant

BAU variant assumes a dynamic increase in demand caused by the growing share of electric vehicles and slow changes in energy efficiency. Therefore, it is a variant that requires large capacity additions in the electricity generation sector. It also chooses the least-cost technology option, taking into account emission cost and boundaries on capacity additions in offshore wind farms and nuclear reactors. Figures 9 and 10 present the electricity generation and net electric attainable power (capacity) for Poland to 2060 by technology groups. More detailed data are presented in Appendix A. Table A1 contains the historical and planned values of electricity production in generation technologies in Poland until 2060. Table A2 shows the historical and planned values of net attainable electric power in Poland until 2060, and Table A3—the utilization factors of these capacities.

The model analysis showed that in the case of significant electrification of transport, assumed in the BAU variant, annual electricity production should be planned at the level of at least 350 TWh/a in 2060, which is more than twice the value recorded in the period 2015–2019. In addition, the model indicates the need to import an additional 20 TWh/a of electricity in 2060. Considering the above conditions and model assumptions, the total net achievable power in 2060 should be over 103 GW, although it should be emphasized that the peak power of solar photovoltaic and microgeneration plants is 39 GW, with the average annual factor of net attainable electric power utilization being 0.10. The restrictions imposed in the model, reflecting the strategic goals of decarbonizing the energy sector, were implemented in the form of assumptions regarding: (1) high prices of CO₂ emission allowances; (2) a limited number of allowances available to Polish generation sources; (3) the indicative target in terms of the share of renewable energy sources in the annual final electricity consumption; (4) tightening environmental standards imposed on power plants and combined heat and power plants.

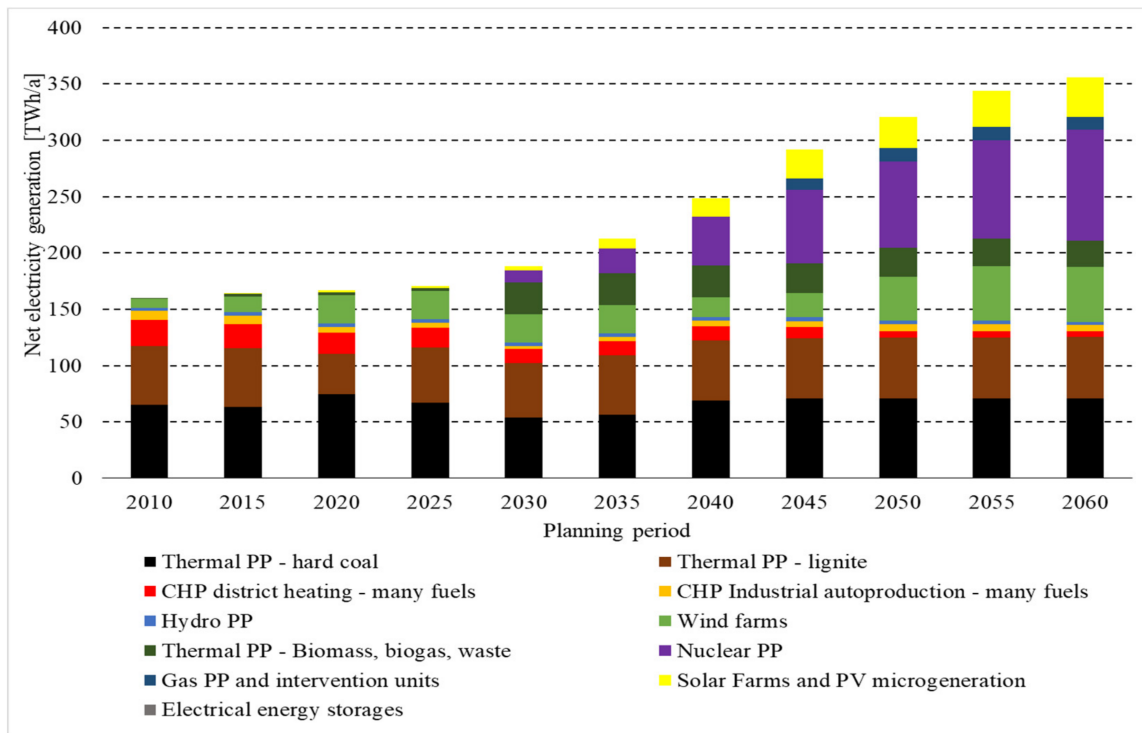

Figure 9. Net electrical energy production planned for Poland by 2060—BAU variant (own study).

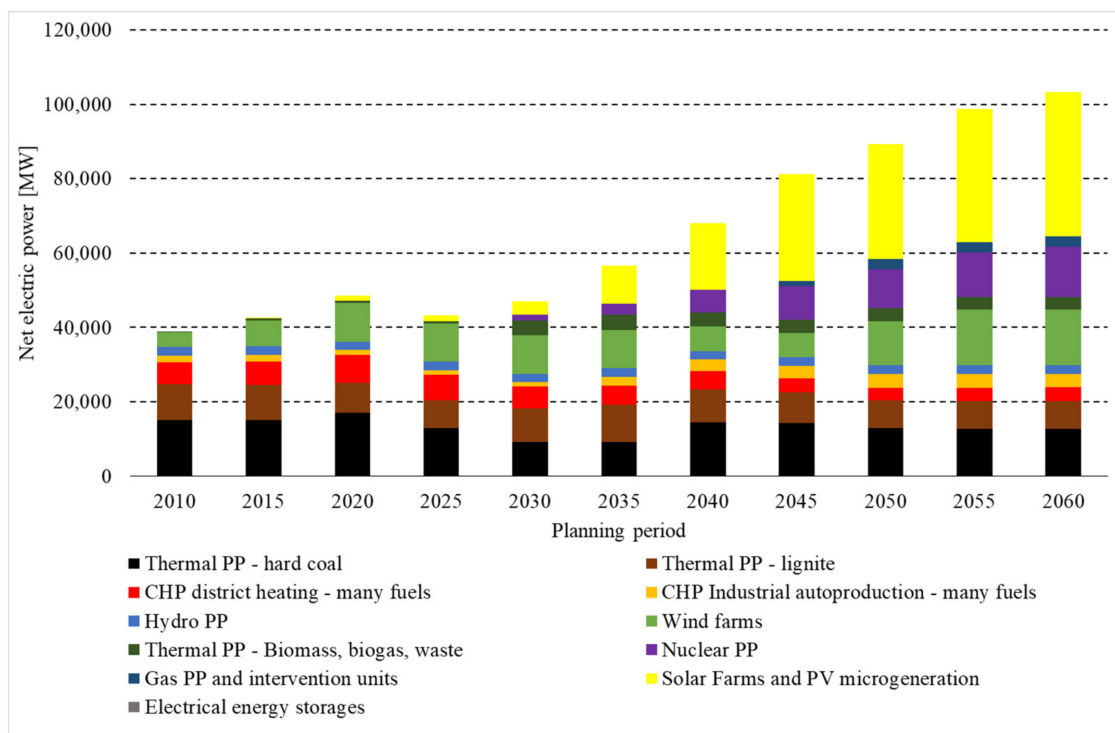

Figure 10. Net attainable electric power planned for Poland by 2060—BAU variant (own study).

The implementation of these assumptions naturally forces the search for low- or zero-emission sources. On the other hand, the developed hard coal and lignite mining industry and experience in the use of coal technologies have allowed Poland to satisfy domestic energy needs for many years, maintaining a high level of security of energy fuel supplies in the long term and electricity security in the short term. The energy transformation in

this variant is gradual, hence the presence of coal technologies throughout the entire time horizon, taking into account new solutions for the capture and storage of CO₂ emissions. Changes in the power system will lead to an increase in the degree of technological diversification, but the whole process is a great challenge in terms of financial expenses for the modernization of the power sector and new solutions in the field of energy storage and management.

Utility thermal power plants built and commissioned by the end of 2014, fired mainly with hard coal and lignite, will be gradually decommissioned until the end of the model time horizon, when they will completely disappear from the electricity generation structure. Constraints imposed on renewable energy sources, in particular wind farms and nuclear power plants, mean that, instead of aging coal-fired power plants, new ones, equipped with CO₂ capture and storage (CCS) systems, should be foreseen, even with high assumed emission allowance prices for CO₂ and constraints on their number. However, the role of such sources will be limited, and the share in the total national net electricity production will be gradually reduced. At the same time, the amount of captured CO₂ in 2060 will amount to 96 million t/a, and in total in the years 2040–2060 it will be 544 million t, which will make use of the assumed CO₂ storage potential at the level of 3.5%.

Hard-coal-fired CHP plants, both utility and industrial, will be partially replaced by gas-fired CHP plants. On the other hand, no new investments in biomass combined heat and power plants are expected after 2024, i.e., after the planned investments are completed. The role of cogeneration in electricity production may decrease despite promoting energy efficiency and supporting the technology itself. High electricity needs, with the simultaneous stabilization of the level of heat demand, will result in the fact that energy resources will be used mainly for the production of electricity, and renewable energy resources will be used for the production of heat in heating plants, which are more difficult to use in the power industry in national conditions, e.g., geothermal energy.

According to the model proposal, assuming a unit capacity of 1500 MW, the first block of a nuclear power plant should be commissioned in the period 2030–2034; the next ones are to be built according to the plan implemented by the author, assuming that in one planning period it is possible to build units with a total capacity of up to 3000 MW. Construction of nuclear power plants in the considered planning horizon requires capital expenditure in excess of (2018) EUR 56 billion in the years 2040–2060.

In order to achieve the assumed indicator targets for the share of electricity in renewable sources (50% by 2060), investments in wind and biomass power plants should be provided for, while the production volume in hydro power plants does not change much in the time horizon under consideration. In line with the applicable law [53], the model has limited investments in onshore wind farms. After 2040, the total available capacity of onshore wind farms is close to zero, and for offshore wind farms it would have to increase to 11 GW in the coming years (by 2024), and then to 15 GW in 2060. The total share of renewable sources in net electricity production in 2060 would amount to 31% in this scenario. Solar power plants, despite their high share in the total net attainable electric power (37.6% in 2060), have a 9.8% share in electricity production in 2060, due to the low average annual capacity utilization factor (0.10—Table A3). Biomass power plants play an important role in the production of electricity (6.6% in 2060), as they are treated as a renewable source with zero net CO₂ emissions. The high share of sources with unpredictable electric power generation characteristics makes it necessary to maintain intervention sources based on gas turbine technology, with a total net attainable electric power of 1.3 GW in 2060. Their capacity utilization is at zero level in the periods 2020–2034 and 2050–2064, which may mean that they will only constitute a reserve of power in the power system during this period.

Although the average annual factor of utilization of net attainable electric power in the entire power system decreases with time, mainly due to the increase in the share of weather-dependent renewable energy sources, this parameter for basic power plants, i.e., nuclear or coal, lignite and biomass-fired power plants, is most often at a level close to the limit

values. The capacity utilization in currently operating coal-fired power plants is decreasing year by year, due to the increasing costs of maintaining these sources, in particular the costs of purchasing CO₂ emission allowances. The investment outlays planned for the period 2020–2060 on electricity generation sources amount to almost (2018) EUR 290 billion, of which most will be needed to build offshore wind farms, photovoltaic power plants, and nuclear power plants. Capital expenditures will increase significantly from the planning period 2035–2039, when they will exceed (2018) EUR 25 billion, and in the next five-year periods, these values will further increase, and may even reach (2018) EUR 59 billion.

3.1.2. Withdrawal from Coal (WFC) Variant

The WFC variant assumes withdrawal from coal-based electricity generation by 2050. Consideration of such a move is the result of the Paris Agreement [54] and the conclusions of subsequent Conferences of the Parties (COPs). Figures 11 and 12 present net electric energy production and net attainable electric power planned for Poland by 2060. More detailed data are presented in Appendix A. Table A4 contains the historical and planned values of electricity production in generation technologies in Poland until 2060. Table A5 shows the historical and planned values of net attainable electric power in Poland until 2060, and Table A6—the utilization factors of these capacities.

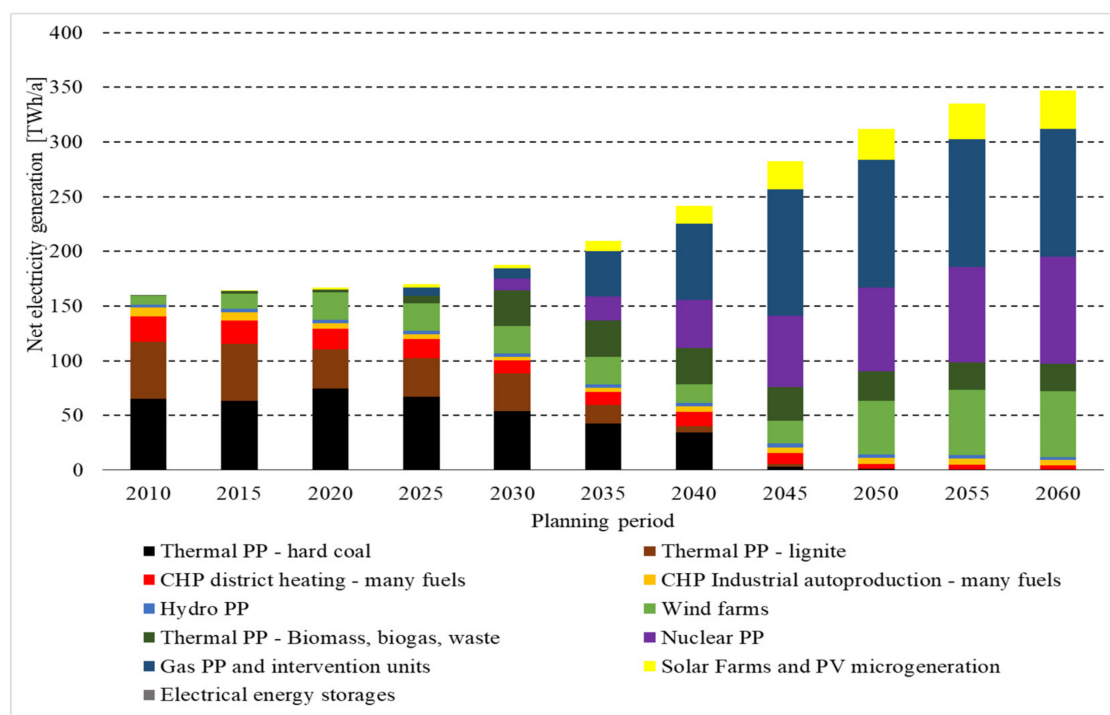

Figure 11. Net electrical energy production planned for Poland by 2060—WFC variant (own study).

The calculations show that coal-based electricity generation is mainly replaced by energy from natural-gas-fueled systems.

3.2. Heat Production

3.2.1. BAU Variant

The structure of district heat production for heating purposes and process heat is presented in Table 2. The growing demand for electricity means that energy resources are mainly used for its production, which forces the search for primary energy sources, the use of which in the power industry is less likely than in heating. Such sources may include geothermal energy. However, building a large number of heat sources of this type in the time schedule proposed in the model may prove to be a considerable challenge.

In the absence of the appropriate potential, it would be necessary to lean towards solar collectors, but these would require a backup source that would compensate for production losses due to low solar levels or significant storage capacities. An alternative solution would be to obtain heat by converting surplus electricity in the power system. With the shutdown of the existing coal and lignite-fired power plants, the production of district heat from these power plants drops to zero in the considered time horizon. A downward trend can be observed in commercial heating plants, but after 2050 it is reversed due to the aforementioned necessity to use a large amount of energy fuels for the production of electricity, as well as due to the high costs of emission allowances.

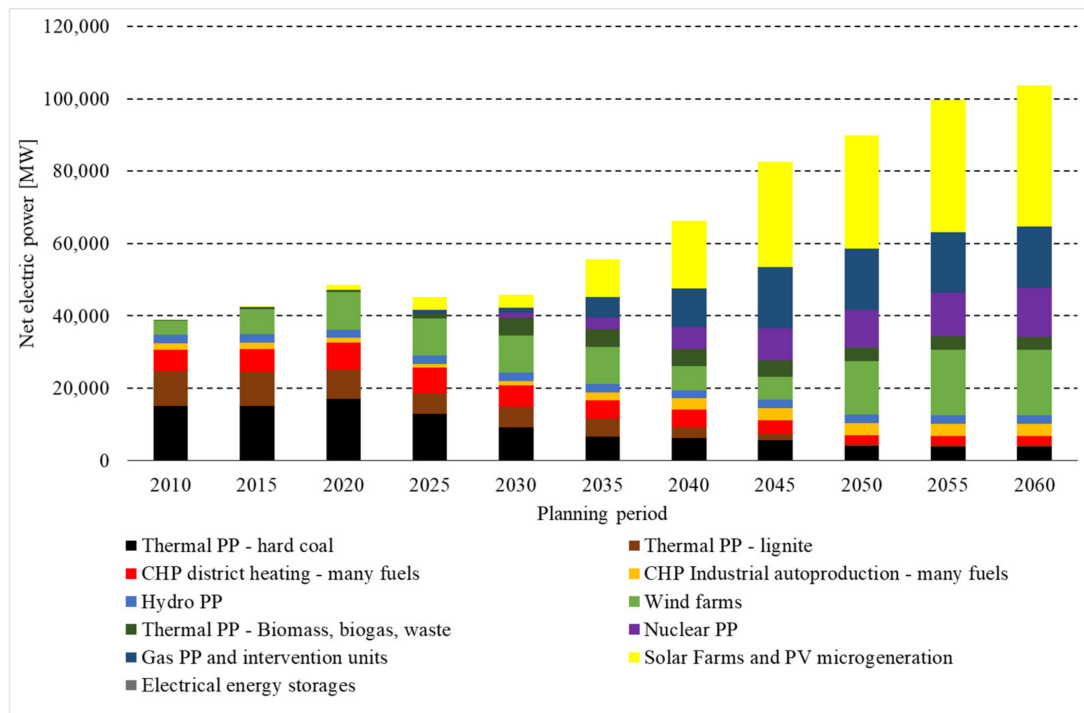

Figure 12. Net electric power (capacity) planned for Poland by 2060—WFC variant (own study).

Table 2. Net heat production from utility and industrial autoproduction plants in Poland to 2060 by technology (PJ/a)—MARKAL-PL—BAU variant (own study).

Technology Group Name	2015	2020	2025	2030	2035	2040	2045	2050	2055	2060
Thermal PP—hard coal, natural gas, biomass (existing)	36.4	25.7	21.5	13.9	3.66	2.50	1.46	0.17	-	-
Thermal PP—lignite, biomass (existing)	16.7	10.4	9.93	5.89	4.14	1.90	0.77	-	-	-
CHP district heating—many fuels (existing)	470	397	316	218	218	225	142	14.4	4.38	3.64
CHP industrial autoproduction—many fuels (existing)	131	86.5	76.4	45.3	48.7	47.4	38.9	33.9	18.8	8.82
CHP district heating—hard coal	0.43	1.73	1.73	1.73	1.73	1.73	0.43	0.86	0.64	-
CHP district heating—natural gas	-	-	17.7	7.8	7.8	7.8	7.8	13.8	13.8	13.8
CHP district heating—biomass	0.27	1.08	1.08	1.08	1.08	1.35	1.01	-	-	-
CHP district heating—waste	1.40	3.11	5.19	7.74	10.3	12.9	20.4	23.0	25.5	25.5
CHP industrial autoproduction—natural gas	-	-	-	0.91	8.14	11.6	11.6	16.2	17.9	12.0
CHP industrial autoproduction—biomass	-	-	-	-	-	7.00	14.0	19.2	26.2	29.1
District heating plants (existing)	61.6	55.0	45.6	34.2	21.3	7.42	4.26	-	-	-
District heating plants—geothermal/solar	-	-	-	-	-	-	84.2	184	201	222
Heating plants—industry and other sectors	-	-	-	-	-	-	3.91	32.1	33.1	33.5
Heat boilers in CHP district heating	14.3	10.7	7.11	3.07	11.3	8.41	6.08	0.64	0.04	0.03
Heat boilers in CHP industrial autoproduction	1.13	0.85	0.56	0.22	0.88	0.79	0.61	0.51	0.43	0.16
Total net heat production	733	592	503	340	337	336	338	339	342	348

3.2.2. WFC Variant

The structure of district heat production for heating purposes and process heat is presented in Table 3. The structures of heat generation are similar in both variants.

Table 3. Net heat production from utility and industrial autoproduction plants in Poland to 2060 by technology (PJ/a)—MARKAL-PL—WFC variant (own study).

Technology Group Name	2015	2020	2025	2030	2035	2040	2045	2050	2055	2060
Thermal PP—hard coal, natural gas, biomass (existing)	36.4	25.7	21.5	13.9	7.30	2.50	1.46	0.17	-	-
Thermal PP—lignite, biomass (existing)	16.7	10.4	9.93	9.78	4.14	1.90	0.77	-	-	-
CHP district heating—many fuels (existing)	470	397	331	214	218	228	149	14.7	4.55	3.80
CHP industrial autoproduction—many fuels (existing)	131	86.5	76.4	45.0	47.0	48.3	38.9	33.9	19.2	8.56
CHP district heating—hard coal	0.43	1.73	3.47	1.73	1.73	1.73	0.86	0.86	0.64	-
CHP district heating—natural gas	-	-	13.8	7.8	7.8	7.8	7.8	7.6	8.0	8.0
CHP district heating—biomass	0.27	1.08	2.17	1.08	1.08	2.17	1.01	-	-	-
CHP district heating—waste	1.40	3.11	5.19	7.74	10.3	12.9	20.4	23.0	25.5	25.5
CHP industrial autoproduction—natural gas	-	-	-	1.25	6.99	12.7	14.0	14.8	16.0	12.7
CHP industrial autoproduction—biomass	-	-	-	-	-	2.06	9.8	15.2	22.5	23.6
District heating plants (existing)	61.6	55.0	45.6	34.2	21.3	7.42	4.26	-	-	14.1
District heating plants—geothermal/solar	-	-	-	-	-	-	77.0	191	208	227
Heating plants—industry and other sectors	-	-	-	-	-	-	6.11	37.0	39.2	25.4
Heat boilers in CHP district heating	14.3	10.7	7.11	3.07	11.3	8.41	6.08	1.28	0.08	0.13
Heat boilers in CHP industrial autoproduction	1.13	0.85	0.56	0.22	0.88	0.79	0.61	0.51	0.43	0.39
Total net heat production	733	592	517	340	338	337	338	340	344	350

3.3. Emissions

Figures 13–16 compare emission levels and reduction paths in relation to the base year (2010) that was arbitrarily chosen to show the effectiveness of the modelling tool in designing low-emission energy systems. Detailed results on emissions of sulfur dioxide, nitrogen oxides, and carbon dioxide in the BAU variant are presented in Tables A7–A9 in Appendix A, respectively. Tables A10–A12 show the emissions of sulfur dioxide, nitrogen oxides, and carbon dioxide, respectively, in the WFC variant.

There is an observable convergence of emission paths in both the BAU and WFC variants. Emissions in the WFC variant are generally lower than in the BAU scenario, as natural gas replaces coal in power generation.

SO₂ emissions from large combustion plants (LCP) mapped in the model amounted to 308 kt/a in 2010, and corresponding NO_x emissions in the same year—190 kt/a. CO₂ emissions from utility power plants and combined heat and power plants totaled 164 million t/a in 1988, the reference year for the emission reduction targets set out in the Kyoto Protocol.

In relation to the year 2010, the SO₂ emissions from electricity and heat generators belonging to the large combustion plants (LCP) group decrease by 2060 by 78% in the BAU variant and 99% in the WFC variant. NO_x reduction in the same period was 61% and 91%, respectively, in the BAU and WFC variant.

Emissions outside LCP also decline due to the slowdown in the development of biomass power plants and CHP plants and a small share of sources emitting these compounds, the power of which does not qualify them for the LCP group. It may also be partly related to the functioning of the EU ETS, although this applies only to the group with thermal power supplied in fuel above 20 MW. Thus, the reduction of SO₂ and NO_x emissions may be a secondary effect of the functioning of the greenhouse gas emission reduction system.

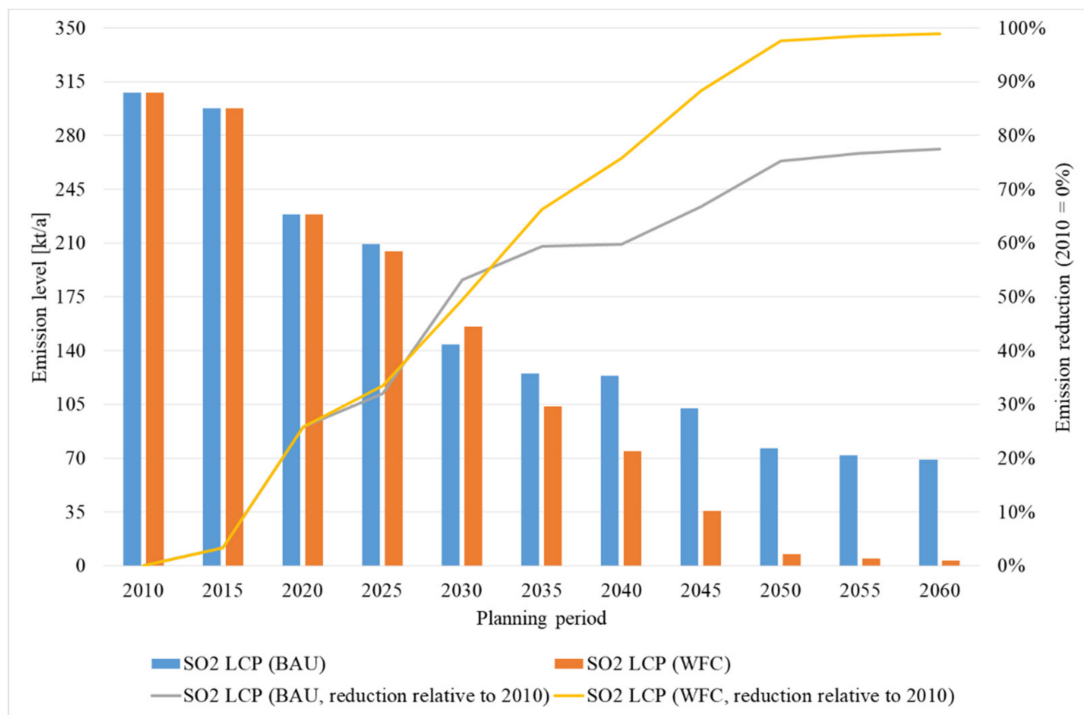

Figure 13. SO₂ emission levels and reduction relative to 2010—power plants, combined heat and power plants, and heating plants falling into the category large combustion plants (LCP).

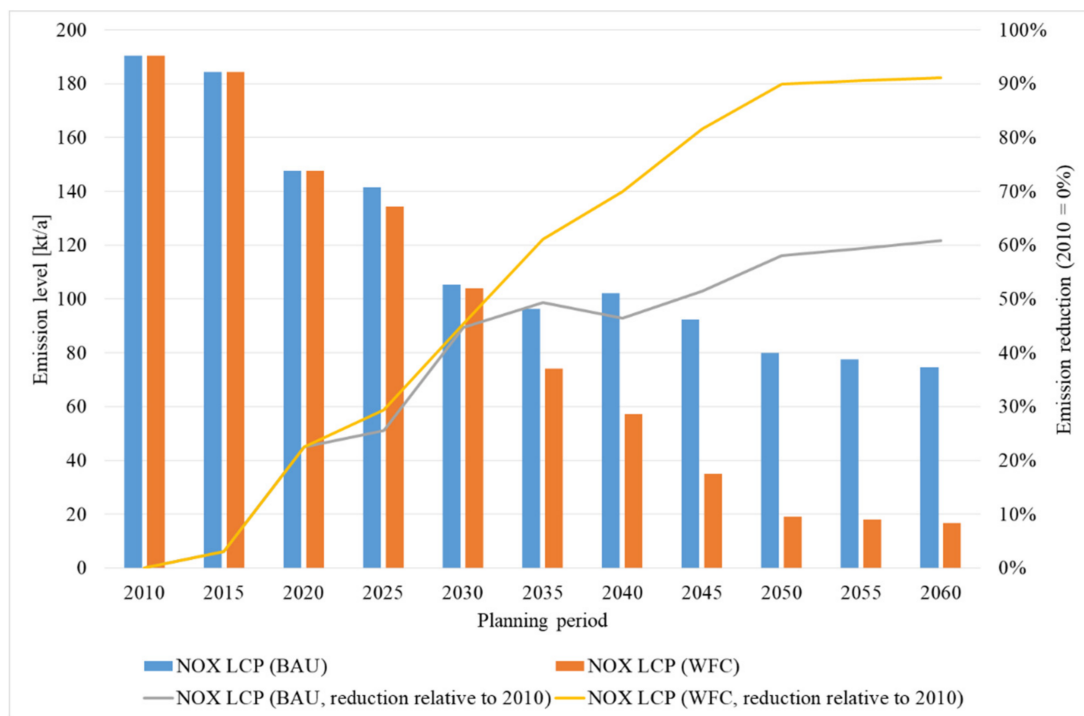

Figure 14. NO_x emission levels and reduction relative to 2010—power plants, combined heat and power plants, and heating plants falling into the category large combustion plants (LCP).

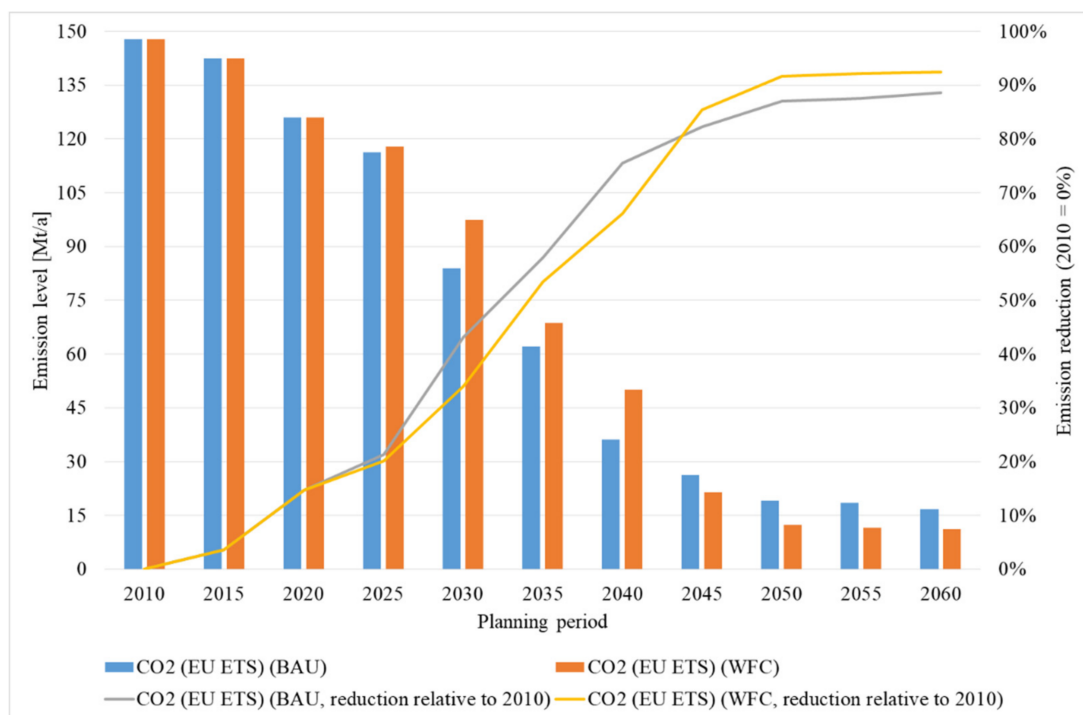

Figure 15. CO₂ emission levels and reduction relative to 2010—power plants, combined heat and power plants, and heating plants participating in European Union Emission Trading Scheme (EU ETS).

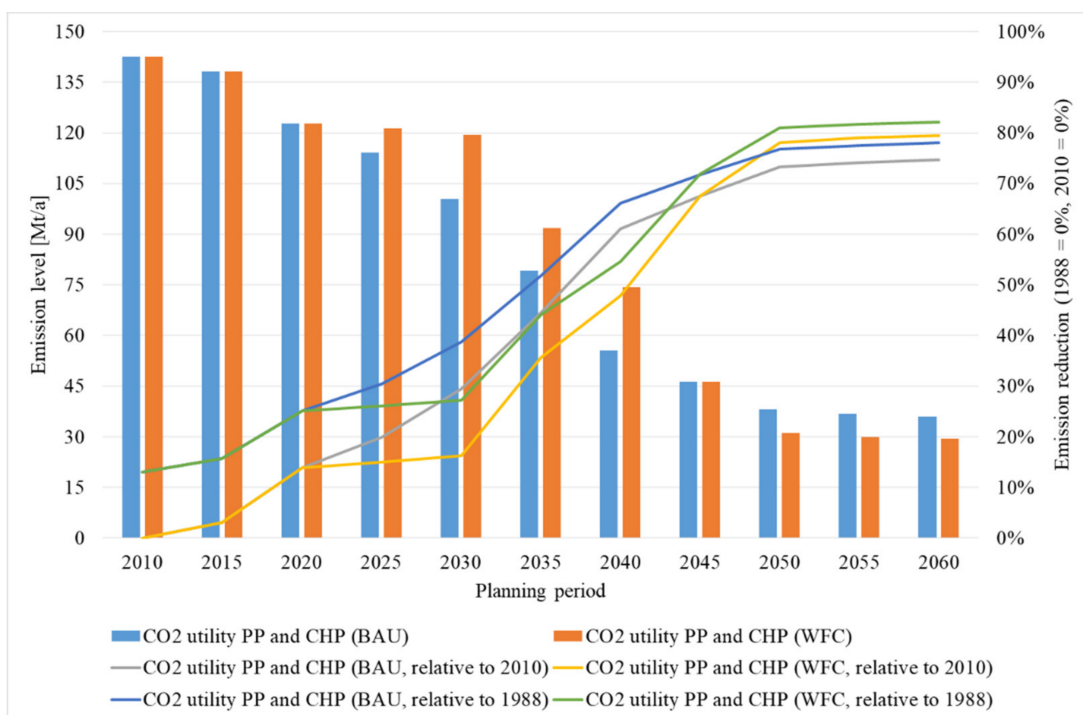

Figure 16. CO₂ emission levels and reduction relative to 1988 and 2010—utility power plants and combined heat and power plants.

In the period 2010–2060, the reduction of CO₂ emissions from energy plants mapped in the model and participating in EU ETS was 89% in the BAU variant and 92% in the WFC variant. The corresponding reduction in utility power plants and CHP plants, belonging to both the ETS and non-ETS sector, was 75% and 79% in the BAU and WFC variant, respec-

tively. If the emission level from the year 1988 (base year for Kyoto Protocol commitments) is used as a reference value, instead of the one from 2010, CO₂ emissions drop by 78% in the BAU and 82% in the WFC variant.

4. Discussion

Referring to the research hypotheses posed in the work, after the model analysis, the authors came to the following conclusions:

1. The electrification of passenger and truck transport will cause a dynamic increase in the demand for electricity, and its pace will depend on the scale of projects aimed at improving the efficiency of end-use energy. It is estimated that gross electric energy demand in 2060 may reach values exceeding 350 TWh/a in the worst case (because it requires the largest investments). New baseload power plants will have to meet demanding emission standards, therefore the model indicates the need to build nuclear power plants, and, if possible, those fired with biomass. In the case of power plants based on fossil fuels, investments in CO₂ capture systems and infrastructure for its transmission and storage will be necessary to keep them in the fuel mix. The power flexibility requirements will promote solutions based on natural gas combustion.
2. Offshore wind farms will be key investments to meet the benchmark target for the share of electricity from renewable sources. However, in the modelling perspective, it was predicted that their total installed capacity would not exceed 15 GW. Another important option will be photovoltaic systems, although due to the low level of peak power utilization, it will be necessary to build a large number of them, which will allow one to obtain the appropriate level of available power. The costs of their implementation may, however, be higher than envisaged in the model, because in order to maintain the safe operation of the power system, it will be necessary to equip them with energy storage systems. The development of “green hydrogen” technology, although it may result in a further increase in costs, is a promising technological option, especially when one uses fuel cells with trace emissions of industrial pollutants and greenhouse gases.
3. The model promotes solutions in the form of centralized power plants, but if it is necessary to completely withdraw from the combustion of coal and natural gas, it is necessary to look for hybrid system solutions, including solar, wind, and fuel cells. Returning to investing in onshore wind farms will be beneficial from the point of view of the power system if one is able to store and manage electricity from these sources. Small nuclear reactors, which are characterized by lower investment risk and create opportunities for cogeneration, could also contribute to the transformation of the structure. The transition to a completely decentralized generation structure does not seem realistic, however.
4. The CO₂ Emissions Trading Scheme is and will be a key tool of the decarbonization policy. The increase in the prices of emission allowances will encourage investors to choose low- and zero-emission technologies. Therefore, in the conditions of a dynamic increase in the price of allowances, the model proposes the construction of nuclear power plants, and in the case of options based on fossil fuels, it is necessary to equip the units with CCS systems. In the district heating sector, technologies based on the use of renewable energy resources, predominantly geothermal energy, should be developed.
5. Taking into account the current pace of technological development, it can be assumed that within 40 years the energy system will be able to function as a set of climate neutral objects. However, looking at the current state of the energy system in general (including transport), the available technological options (including slowly developing fuel cells) and potentially new options (e.g., batteries) are unlikely.

Thus, the model study confirmed the correctness of the research hypotheses. At the same time, the presented vision of development indicates the need to undertake a

number of important projects that are also consistent with the assumptions of the Polish energy policy:

1. Commissioning of the first offshore wind farms by 2025;
2. Preparation of industry and human resources for the construction of nuclear power plants by 2025–2030;
3. Preparation of workforce for the operation of nuclear power plants in the 2035–2040 perspective;
4. Conducting research and development works in the field of energy storage systems and energy management in power transmission and distribution systems, in particular in the face of increasing capacity in photovoltaic systems and offshore wind farms;
5. Detailed studies of the domestic storage potential and possibilities for the development of liquefied CO₂ transport infrastructure;
6. Detailed research on the potential of geothermal energy to produce district heat for large urban agglomerations.

5. Conclusions

Modelling tools for the development of energy systems are an element of supporting investment decisions in electricity and heat generation technologies. It is true that it is difficult to consider them as an oracle and to rely solely on the results of modelling, but one can set directions for the development of generation infrastructure. With this knowledge, one can plan construction projects, capital expenditures, research and development programs, etc. The elaboration of the model results is only one stage of the entire planning process for the development of energy systems. The next stage includes detailed analyses for individual technological options and projects for the construction of specific power plants. Each project must be preceded by a feasibility study, including a detailed technical and economic analysis, which will help to determine the conditions for the profitability of the project. Each investment is burdened with investment risk and the higher the risk, the higher the investment expenditure on a given project.

Despite covering many of the aspects of generation expansion planning in this study, still there are some issues that require further consideration. Long-term models have limited capabilities to address the intermittency of solar and wind installations, which limits the deployment of energy storages in the modelling solution. It is recommended to include in the model the hybrid systems, consisting of intermittent energy sources and energy storages, which should be preceded by detailed techno-economic analyses aimed at sizing storage capacity and determining cost characteristics of a technology. Furthermore, the storage of large amounts of CO₂ may prove to be infeasible over several decades' worth of perspectives. Inclusion of the options that facilitate utilization of CO₂ should be considered in future studies. As the technology is still immature, the techno-economic data, including technology learning rates, are burdened with uncertainty.

Currently, Poland aims at implementing programs that are a part of the national policy document (PEP2040). Construction of the offshore wind farms is at the beginning stage of the investment process, i.e., contracts and agreements are being signed with a perspective of a commissioning by the middle of the present decade. The nuclear program is at the stage of studies of potential localizations, limited to a short list including two sites in Northern Poland. The year 2022 should bring the choice of technology vendor and a final decision regarding the installation of the first nuclear block, which is expected to be completed by the year 2034. The government also commissioned a detailed study on the potential and techno-economic feasibility of carbon capture, utilization, and storage (CCUS) options to examine the possibility of keeping coal-based energy plants in operation. Renewable energy sources are supported by the auctioning system, i.e., specific capacity is commissioned by the president of the Energy Regulatory Office and the winning bid benefits from a premium electricity price (higher than the average wholesale market price) over the 15-year period or until the year 2035. Prosumers (mostly PV system owners) will benefit from net metering until the end of March 2022. After that, excess electricity (not



used by the prosumer) will be cleared using the average wholesale market price. The latter move is expected to decelerate the pace of capacity growth in prosumer installation capacity and encourage them to size PV systems to cover mostly their needs. The major concern is the stability of the network and insufficient capacity in electricity storage systems.

Building sustainable energy systems, although difficult, is feasible, and the condition of the current infrastructure, requiring the reconstruction of a significant part of the power plants built in the second half of the twentieth century, is a chance to realize the dream of low-emission energy production. At stake in this game are the life, health, and wellbeing of society, and these will certainly improve when the negative impact of energy on the environment is reduced.

Author Contributions: Conceptualization, M.J. and P.B.; data curation, P.B.; formal analysis, P.B.; investigation, M.J.; methodology, M.J. and P.B.; resources, M.J.; software, M.J.; supervision, P.B.; validation, M.J. and P.B.; visualization, M.J.; writing—original draft, M.J.; writing—review and editing, P.B. All authors have read and agreed to the published version of the manuscript.

Funding: This research received no external funding. The APC was funded by The Faculty of Electrical and Control Engineering, Gdańsk University of Technology.

Institutional Review Board Statement: Not applicable.

Informed Consent Statement: Not applicable.

Conflicts of Interest: The authors declare no conflict of interest.

Appendix A

Table A1. Net electricity production in Poland to 2060 by technology (TWh/a)—MARKAL-PL—BAU variant (own study).

Technology Group Name	2015	2020	2025	2030	2035	2040	2045	2050	2055	2060
Thermal PP—hard coal, natural gas, biomass (existing)	63.4	44.7	37.3	24.2	6.36	4.34	2.54	0.29	-	-
Thermal PP—lignite, biomass (existing)	52.1	32.2	30.9	18.3	12.9	5.93	2.40	-	-	-
CHP district heating—many fuels (existing)	21.1	17.9	14.3	9.92	9.49	9.93	5.78	0.46	0.14	0.12
CHP industrial autoproduction—many fuels (existing)	7.29	4.79	4.21	2.49	2.69	2.62	2.16	1.87	1.03	0.48
Hydro PP (existing)	2.81	2.81	2.94	2.94	2.94	2.94	3.07	3.07	2.47	2.10
Renewable sources (existing)	8.89	8.89	8.89	8.75	8.89	7.51	0.33	0.33	0.33	0.33
Thermal PP—hard coal	-	29.9	29.9	29.9	29.9	-	-	-	-	-
Thermal PP—lignite	-	3.78	3.78	3.78	-	-	-	-	-	-
Thermal PP—hard coal + CCS	-	-	-	-	20.4	64.8	68.5	70.8	70.8	70.8
Thermal PP—lignite + CCS	-	-	13.8	26.2	39.8	47.0	51.0	53.8	54.2	54.6
Nuclear PP	-	-	-	10.9	21.8	43.6	65.4	76.3	87.2	98.2
Gas PP and intervention units	-	-	-	-	-	-	-	2.01	1.75	1.51
Gas PP with CCS	-	-	-	-	-	-	10.4	10.4	10.4	10.4
CHP district heating—hard coal	0.05	0.19	0.19	0.19	0.19	0.19	0.05	0.10	0.07	-
CHP district heating—natural gas	-	-	2.51	1.11	1.11	1.11	1.11	1.96	1.96	1.96
CHP district heating—biomass	0.03	0.12	0.12	0.12	0.12	0.15	0.11	-	-	-
CHP district heating—waste	0.18	0.39	0.65	0.97	1.29	1.61	2.55	2.87	3.19	3.19
CHP industrial autoproduction—natural gas	-	-	-	0.13	1.15	1.64	1.64	2.30	2.54	1.70
CHP industrial autoproduction—biomass	-	-	-	-	-	0.78	1.56	2.13	2.92	3.24
Wind farms—inland	6.61	6.61	6.61	6.61	6.61	-	-	-	-	-
Wind farms—offshore	-	10.8	10.8	10.8	10.8	10.8	21.6	38.6	48.9	48.9
Solar farms and PV microgeneration	0.27	1.38	1.38	3.27	9.23	16.0	25.8	27.6	32.1	34.8
Thermal PP—biomass	-	0.73	0.73	26.0	26.0	26.0	26.0	26.0	24.1	23.6
Thermal PP—waste	1.37	1.37	1.37	1.37	1.37	1.37	-	-	-	-
Electrical energy storages	-	-	-	-	-	-	-	-	-	-
Total net electricity production	164	167	170	188	213	248	292	321	344	356
Import	3.90	10.5	16.4	17.2	18.1	19.0	19.9	20.9	22.0	23.1
Export	3.29	3.29	3.29	3.29	3.29	3.29	3.29	3.29	3.29	3.29
Total net electricity supply	165	174	184	202	228	264	309	338	363	376

Table A2. Net electric generation capacity of Poland to 2060 by technology (GW)—MARKAL-PL—BAU variant (own study).

Technology Group Name	2015	2020	2025	2030	2035	2040	2045	2050	2055	2060
Thermal PP—hard coal, natural gas, biomass (existing)	15.2	13.2	9.08	5.42	2.84	2.46	1.77	0.25	-	-
Thermal PP—lignite, biomass (existing)	9.44	7.57	5.26	5.26	4.50	2.56	1.32	-	-	-
CHP district heating—many fuels (existing)	5.96	5.69	5.15	3.92	3.23	2.83	1.77	0.20	0.05	0.05
CHP industrial autoproduction—many fuels (existing)	1.77	1.36	1.10	0.99	0.77	0.64	0.54	0.49	0.28	0.16
Hydro PP (existing)	2.23	2.23	2.23	2.23	2.23	2.23	2.23	2.23	2.23	2.22
Renewable sources (existing)	4.17	4.17	4.17	4.17	4.17	3.43	0.09	0.09	0.09	0.09
Thermal PP—hard coal	-	3.80	3.80	3.80	3.80	3.80	3.80	3.80	3.80	3.80
Thermal PP—lignite	-	0.48	0.48	0.48	0.48	0.48	0.48	0.48	0.48	0.48
Thermal PP—hard coal + CCS	-	-	-	-	2.59	8.22	8.69	8.98	8.98	8.98
Thermal PP—lignite + CCS	-	-	1.75	3.32	5.05	5.96	6.47	6.83	6.87	6.92
Nuclear PP	-	-	-	1.50	3.00	6.00	9.00	10.5	12.0	13.5
Gas PP and intervention units	-	-	-	-	-	-	-	1.27	1.31	1.31
Gas PP with CCS	-	-	-	-	-	-	1.43	1.43	1.43	1.43
CHP district heating—hard coal	0.03	0.10	0.10	0.10	0.10	0.10	0.10	0.10	0.08	-
CHP district heating—natural gas	0.15	1.53	1.53	1.53	1.53	1.53	1.53	2.70	2.70	2.70
CHP district heating—biomass	0.01	0.05	0.05	0.05	0.05	0.05	0.04	-	-	-
CHP district heating—waste	0.05	0.15	0.20	0.20	0.20	0.23	0.40	0.51	0.85	1.00
CHP industrial autoproduction—natural gas	-	-	-	0.18	1.59	2.26	2.26	2.78	2.78	2.78
CHP industrial autoproduction—biomass	-	-	-	-	-	0.26	0.43	0.49	0.72	0.72
Wind farms—inland	3.13	3.13	3.13	3.13	3.13	-	-	-	-	-
Wind farms—offshore	-	3.28	3.28	3.28	3.28	3.28	6.57	11.7	14.8	14.8
Solar farms and PV microgeneration	0.30	1.54	1.54	3.65	10.3	17.9	28.7	30.8	35.8	38.8
Thermal PP—biomass	-	0.10	0.10	3.57	3.57	3.57	3.57	3.57	3.47	3.47
Thermal PP—waste	0.24	0.24	0.24	0.24	0.24	0.24	-	-	-	-
Electrical energy storages	-	-	-	-	-	-	-	-	-	-
Total net electric capacity	42.7	48.6	43.2	47.0	56.6	68.0	81.2	89.2	98.7	103

Table A3. Utilization factor of the net electric generation capacity of Poland to 2060 by technology (-)—MARKAL-PL—BAU variant (own study).

Technology Group Name	2015	2020	2025	2030	2035	2040	2045	2050	2055	2060
Thermal PP—hard coal, natural gas, biomass (existing)	0.48	0.39	0.47	0.51	0.26	0.20	0.16	0.13	-	-
Thermal PP—lignite, biomass (existing)	0.63	0.49	0.67	0.40	0.33	0.26	0.21	-	-	-
CHP district heating—many fuels (existing)	0.40	0.36	0.32	0.29	0.34	0.40	0.37	0.27	0.30	0.28
CHP industrial autoproduction—many fuels (existing)	0.47	0.40	0.44	0.29	0.40	0.47	0.45	0.44	0.42	0.35
Hydro PP (existing)	0.14	0.14	0.15	0.15	0.15	0.15	0.16	0.16	0.13	0.11
Renewable sources (existing)	0.24	0.24	0.24	0.24	0.24	0.25	0.42	0.42	0.42	0.42
Thermal PP—hard coal	-	0.90	0.90	0.90	0.90	-	-	-	-	-
Thermal PP—lignite	-	0.90	0.90	0.90	-	-	-	-	-	-
Thermal PP—hard coal + CCS	-	-	-	-	0.90	0.90	0.90	0.90	0.90	0.90
Thermal PP—lignite + CCS	-	-	0.90	0.90	0.90	0.90	0.90	0.90	0.90	0.90
Nuclear PP	-	-	-	0.83	0.83	0.83	0.83	0.83	0.83	0.83
Gas PP and intervention units	-	-	-	-	-	-	-	0.18	0.15	0.13
Gas PP with CCS	-	-	-	-	-	-	0.83	0.83	0.83	0.83
CHP district heating—hard coal	0.22	0.22	0.22	0.22	0.22	0.22	0.05	0.11	0.11	-
CHP district heating—natural gas	-	-	0.19	0.08	0.08	0.08	0.08	0.08	0.08	0.08
CHP district heating—biomass	0.27	0.27	0.27	0.27	0.27	0.34	0.34	-	-	-
CHP district heating—waste	0.40	0.30	0.37	0.55	0.73	0.80	0.73	0.64	0.43	0.36
CHP industrial autoproduction—natural gas	-	-	-	0.08	0.08	0.08	0.08	0.09	0.10	0.07
CHP industrial autoproduction—biomass	-	-	-	-	-	0.34	0.41	0.50	0.46	0.52
Wind farms—inland	0.24	0.24	0.24	0.24	0.24	-	-	-	-	-
Wind farms—offshore	-	0.38	0.38	0.38	0.38	0.38	0.38	0.38	0.38	0.38

Table A3. Cont.

Technology Group Name	2015	2020	2025	2030	2035	2040	2045	2050	2055	2060
Solar farms and PV microgeneration	0.10	0.10	0.10	0.10	0.10	0.10	0.10	0.10	0.10	0.10
Thermal PP—biomass	-	0.83	0.83	0.83	0.83	0.83	0.83	0.83	0.79	0.78
Thermal PP—waste	0.65	0.65	0.65	0.65	0.65	0.65	-	-	-	-
Electrical energy storages	-	-	-	-	-	-	-	-	-	-
Average net electric capacity utilization factor	0.44	0.39	0.45	0.46	0.43	0.42	0.41	0.41	0.40	0.39

Table A4. Net electricity production in Poland to 2060 by technology (TWh/a)—MARKAL-PL—WFC variant (own study).

Technology Group Name	2015	2020	2025	2030	2035	2040	2045	2050	2055	2060
Thermal PP—hard coal, natural gas, biomass (existing)	63.4	44.7	37.3	24.2	12.70	4.34	2.54	0.29	-	-
Thermal PP—lignite, biomass (existing)	52.1	32.2	30.9	30.4	12.9	5.93	2.40	-	-	-
CHP district heating—many fuels (existing)	21.1	17.9	14.9	9.80	9.49	10.1	6.14	0.47	0.15	0.12
CHP industrial autoproduction—many fuels (existing)	7.29	4.79	4.21	2.48	2.60	2.67	2.16	1.87	1.05	0.47
Hydro PP (existing)	2.81	2.81	2.94	2.94	2.94	2.94	3.07	3.07	2.49	2.32
Renewable sources (existing)	8.89	8.89	8.89	8.89	8.89	7.51	0.33	0.33	0.33	0.33
Thermal PP—hard coal	-	29.9	29.9	29.9	29.9	29.9	0.59	0.69	0.38	0.13
Thermal PP—lignite	-	3.78	3.78	3.78	3.8	-	-	-	-	-
Nuclear PP	-	-	-	10.9	21.8	43.6	65.4	76.3	87.2	98.2
Gas PP and intervention units	-	-	7.4	7.4	7.4	-	-	1.83	1.83	1.83
Gas PP with CCS	-	-	-	1.7	34.5	69.7	115	115	115	115
CHP district heating—hard coal	0.05	0.19	0.39	0.19	0.19	0.19	0.10	0.10	0.07	-
CHP district heating—natural gas	-	-	1.96	1.11	1.11	1.11	1.11	1.08	1.13	1.13
CHP district heating—biomass	0.03	0.12	0.24	0.12	0.12	0.24	0.11	-	-	-
CHP district heating—waste	0.18	0.39	0.65	0.97	1.29	1.61	2.55	2.87	3.19	3.19
CHP industrial autoproduction—natural gas	-	-	-	0.18	0.99	1.80	1.98	2.09	2.27	1.80
CHP industrial autoproduction—biomass	-	-	-	-	-	0.23	1.09	1.69	2.49	2.62
Wind farms—inland	6.61	6.61	6.61	6.61	6.61	-	-	-	-	-
Wind farms—offshore	-	10.8	10.8	10.8	10.8	10.8	20.8	48.8	59.7	59.7
Solar farms and PV microgeneration	0.27	1.38	3.21	3.21	9.34	16.8	26.1	28.1	32.7	35.0
Thermal PP—biomass	-	0.73	0.73	26.8	27.1	27.1	27.1	27.1	25.2	25.2
Thermal PP—biogas	-	-	3.77	3.77	3.77	3.77	3.77	-	-	-
Thermal PP—waste	1.37	1.37	1.37	1.37	1.37	1.37	-	-	-	-
Electrical energy storages	-	-	-	-	-	-	-	-	-	-
Total net electricity production	164	167	170	188	210	242	283	312	335	347
Import	3.89	10.5	16.4	17.2	18.1	19.0	19.9	20.9	22.0	23.1
Export	-3.29	-3.29	-3.29	-3.29	-3.29	-3.29	-3.29	-3.29	-3.29	-3.29
Total net electricity supply	165	174	183	201	224	258	299	329	354	367

Table A5. Net electric generation capacity of Poland to 2060 by technology (GW)—MARKAL-PL—WFC variant (own study).

Technology Group Name	2015	2020	2025	2030	2035	2040	2045	2050	2055	2060
Thermal PP—hard coal, natural gas, biomass (existing)	15.2	13.2	9.08	5.42	2.84	2.46	1.77	0.25	-	-
Thermal PP—lignite, biomass (existing)	9.44	7.57	5.26	5.26	4.50	2.56	1.32	-	-	-
CHP district heating—many fuels (existing)	5.96	5.69	5.15	3.92	3.23	2.83	1.77	0.20	0.05	0.05
CHP industrial autoproduction—many fuels (existing)	1.77	1.36	1.10	0.99	0.77	0.64	0.54	0.49	0.28	0.16
Hydro PP (existing)	2.23	2.23	2.23	2.23	2.23	2.23	2.23	2.23	2.23	2.22
Renewable sources (existing)	4.17	4.17	4.17	4.17	4.17	3.43	0.09	0.09	0.09	0.09
Thermal PP—hard coal	-	3.80	3.80	3.80	3.80	3.80	3.80	3.80	3.80	3.80
Thermal PP—lignite	-	0.48	0.48	0.48	0.48	0.48	0.48	0.48	0.48	0.48
Nuclear PP	-	-	-	1.50	3.00	6.00	9.00	10.5	12.0	13.5
Gas PP and intervention units	-	-	1.02	1.02	1.02	1.02	1.02	1.02	1.02	1.02
Gas PP with CCS	-	-	-	0.23	4.75	9.59	15.84	15.84	15.84	15.84

Table A5. Cont.

Technology Group Name	2015	2020	2025	2030	2035	2040	2045	2050	2055	2060
CHP district heating—hard coal	0.03	0.10	0.10	0.10	0.10	0.10	0.10	0.10	0.08	-
CHP district heating—natural gas	0.15	1.53	1.53	1.53	1.53	1.53	1.53	1.49	1.57	1.57
CHP district heating—biomass	0.01	0.05	0.05	0.05	0.05	0.05	0.04	-	-	-
CHP district heating—waste	0.05	0.15	0.20	0.20	0.20	0.23	0.39	0.63	0.89	1.04
CHP industrial autoproduction—natural gas	-	-	-	0.24	1.37	2.49	2.49	2.49	2.49	2.49
CHP industrial autoproduction—biomass	-	-	-	-	-	0.05	0.26	0.42	0.62	0.62
Wind farms—inland	3.13	3.13	3.13	3.13	3.13	-	-	-	-	-
Wind farms—offshore	-	3.28	3.28	3.28	3.28	3.28	6.31	14.8	18.1	18.1
Solar farms and PV microgeneration	0.30	1.54	3.58	3.58	10.4	18.8	29.1	31.3	36.5	39.0
Thermal PP—biomass	-	0.10	0.10	3.68	3.73	3.73	3.73	3.73	3.63	3.63
Thermal PP—biogas	-	-	0.76	0.76	0.76	0.76	0.76	-	-	-
Thermal PP—waste	0.24	0.24	0.24	0.24	0.24	0.24	-	-	-	-
Electrical energy storages	-	-	-	-	-	-	-	-	-	-
Total net electrical capacity	42.7	48.6	45.3	45.8	55.6	66.2	82.5	89.9	99.7	104

Table A6. Utilization factor of the net electric generation capacity of Poland to 2060 by technology (-)—MARKAL-PL—WFC variant (own study).

Technology Group Name	2015	2020	2025	2030	2035	2040	2045	2050	2055	2060
Thermal PP—hard coal, natural gas, biomass (existing)	0.48	0.39	0.47	0.51	0.51	0.20	0.16	0.13	-	-
Thermal PP—lignite, biomass (existing)	0.63	0.49	0.67	0.66	0.33	0.26	0.21	-	-	-
CHP district heating—many fuels (existing)	0.40	0.36	0.33	0.29	0.34	0.41	0.40	0.27	0.32	0.30
CHP industrial autoproduction—many fuels (existing)	0.47	0.40	0.44	0.29	0.39	0.48	0.45	0.44	0.42	0.34
Hydro PP (existing)	0.14	0.14	0.15	0.15	0.15	0.15	0.16	0.16	0.13	0.12
Renewable sources (existing)	0.24	0.24	0.24	0.24	0.24	0.25	0.42	0.42	0.42	0.42
Thermal PP—hard coal	-	0.90	0.90	0.90	0.90	0.90	0.02	0.02	0.01	0.00
Thermal PP—lignite	-	0.90	0.90	0.90	0.90	-	-	-	-	-
Nuclear PP	-	-	-	0.83	0.83	0.83	0.83	0.83	0.83	0.83
Gas PP and intervention units	-	-	0.83	0.83	0.83	-	-	0.20	0.20	0.20
Gas PP with CCS	-	-	-	0.83	0.83	0.83	0.83	0.83	0.83	0.83
CHP district heating—hard coal	0.22	0.22	0.44	0.22	0.22	0.22	0.11	0.11	0.11	-
CHP district heating—natural gas	-	-	0.15	0.08	0.08	0.08	0.08	0.08	0.08	0.08
CHP district heating—biomass	0.27	0.27	0.55	0.27	0.27	0.55	0.34	-	-	-
CHP district heating—waste	0.40	0.30	0.37	0.55	0.73	0.80	0.75	0.52	0.41	0.35
CHP industrial autoproduction—natural gas	-	-	-	0.08	0.08	0.08	0.09	0.10	0.10	0.08
CHP industrial autoproduction—biomass	-	-	-	-	-	0.55	0.48	0.46	0.46	0.48
Wind farms—inland	0.24	0.24	0.24	0.24	0.24	-	-	-	-	-
Wind farms—offshore	-	0.38	0.38	0.38	0.38	0.38	0.38	0.38	0.38	0.38
Solar farms and PV microgeneration	0.10	0.10	0.10	0.10	0.10	0.10	0.10	0.10	0.10	0.10
Thermal PP—biomass	-	0.83	0.83	0.83	0.83	0.83	0.83	0.83	0.79	0.79
Thermal PP—biogas	-	-	0.57	0.57	0.57	0.57	0.57	-	-	-
Thermal PP—waste	0.65	0.65	0.65	0.65	0.65	0.65	-	-	-	-
Electrical energy storages	-	-	-	-	-	-	-	-	-	-

Table A7. SO₂ emissions from electricity and heat-generating plants in Poland to 2060 by technology (kt/a)—MARKAL-PL—BAU variant (own study).

Emission Category	2015	2020	2025	2030	2035	2040	2045	2050	2055	2060
Emissions from PP and CHP (non-LCP)	22.0	15.6	15.3	8.93	9.67	7.73	7.02	5.95	4.01	3.18
Emissions from DHP (non-LCP)	12.2	10.6	8.49	6.01	5.24	2.55	1.67	0.14	0.04	0.04
Emissions from LCP	298	228	209	144	125	124	102	76.3	72.0	69.3
Total emissions from PP, CHP, and DHP	332	255	233	159	140	134	111	82.4	76.0	72.5

Table A8. NO_x emissions from electricity and heat-generating plants in Poland to 2060 by technology (kt/a)—MARKAL-PL—BAU variant (own study).

Emission Category	2015	2020	2025	2030	2035	2040	2045	2050	2055	2060
Emissions from PP and CHP (non-LCP)	11.9	8.52	7.52	14.7	15.1	15.6	14.9	14.9	13.4	12.9
Emissions from DHP (non-LCP)	0.00	0.00	0.00	0.00	0.00	0.00	0.00	0.00	0.00	0.00
Emissions from LCP	184	147	142	105	96.3	102	92.3	79.8	77.4	74.6
Total emissions from PP, CHP, and DHP	196	156	149	120	111	118	107	94.7	90.8	87.5

Table A9. CO₂ emissions from electricity and heat-generating plants in Poland to 2060 by technology (Mt/a)—MARKAL-PL—BAU variant (own study).

Emission Category	2015	2020	2025	2030	2035	2040	2045	2050	2055	2060
PP and CHP (non-EU ETS)	5.66	4.86	4.62	21.4	21.6	23.0	23.6	24.3	23.6	23.4
Utility PP existing (EU ETS)	107	70.6	63.3	39.1	19.0	9.86	4.61	0.23	0.00	0.00
Utility PP new (EU ETS)	0.00	25.7	26.3	26.8	26.0	9.49	10.3	11.1	11.1	10.6
Utility CHP existing (EU ETS)	25.2	21.3	17.0	11.7	11.0	11.7	6.58	0.25	0.03	0.02
Utility CHP new (EU ETS)	0.07	0.28	2.95	1.47	1.47	1.47	1.25	2.22	2.19	2.08
Industrial autoproduction CHP existing (EU ETS)	3.64	2.40	2.06	1.20	1.23	1.16	1.09	0.94	0.49	0.31
Industrial autoproduction CHP new (EU ETS)	0.00	0.00	0.00	0.14	1.23	1.75	1.75	2.45	2.71	1.81
Utility DHP existing (EU ETS)	6.22	5.55	4.61	3.46	2.15	0.75	0.66	1.92	1.99	2.01
Utility DHP new (EU ETS)	0.00	0.00	0.00	0.00	0.00	0.00	0.00	0.00	0.00	0.00
Total emissions (EU ETS)	142	126	116	83.9	62.0	36.2	26.3	19.2	18.5	16.8
Total emission over all categories	148	131	121	105	83.7	59.2	49.9	43.4	42.1	40.2
Total emissions from utility PP and CHP	138	123	114	101	79.1	55.5	46.4	38.1	36.9	36.1

Table A10. SO₂ emissions from electricity and heat-generating plants in Poland to 2060 by technology (kt/a)—MARKAL-PL—WFC variant (own study).

Emission Category	2015	2020	2025	2030	2035	2040	2045	2050	2055	2060
Emissions from PP and CHP (non-LCP)	22.0	15.6	15.5	8.98	9.87	8.14	7.19	5.95	4.09	3.12
Emissions from DHP (non-LCP)	12.2	10.6	8.49	6.01	5.24	2.55	1.67	0.24	0.05	2.32
Emissions from LCP	298	228	205	156	104	74.7	36.0	7.65	4.64	3.24
Total emissions from PP, CHP, and DHP	332	255	229	171	119	85.4	44.9	13.8	8.78	8.68

Table A11. NO_x emissions from electricity and heat-generating plants in Poland to 2060 by technology (kt/a)—MARKAL-PL—WFC variant (own study).

Emission Category	2015	2020	2025	2030	2035	2040	2045	2050	2055	2060
Emissions from PP and CHP (non-LCP)	11.9	8.52	11.27	18.3	19.1	19.3	18.5	14.9	13.5	12.8
Emissions from DHP (non-LCP)	0.00	0.00	0.00	0.00	0.00	0.00	0.00	0.00	0.00	0.00
Emissions from LCP	184	147	134	104	74.0	57.1	35.0	19.1	18.0	16.9
Total emissions from PP, CHP, and DHP	196	156	146	122	93.1	76.3	53.5	34.0	31.4	29.7

Table A12. CO₂ emissions from electricity and heat-generating plants in Poland to 2060 by technology (Mt/a)—MARKAL-PL—WFC variant (own study).

Specification	2015	2020	2025	2030	2035	2040	2045	2050	2055	2060
PP and CHP (non-EU ETS)	5.66	4.86	10.0	26.9	27.5	28.2	28.7	24.3	23.6	23.3
Utility PP existing (EU ETS)	107	70.6	63.3	52.3	24.0	9.86	4.61	0.23	0.00	0.00
Utility PP new (EU ETS)	0.00	25.7	27.6	27.2	27.8	23.0	4.54	5.19	4.98	4.82
Utility CHP existing (EU ETS)	25.2	21.3	17.7	11.7	11.0	11.9	7.03	0.27	0.04	0.03
Utility CHP new (EU ETS)	0.07	0.28	2.65	1.47	1.47	1.47	1.32	1.29	1.31	1.21
Industrial autoproduction CHP existing (EU ETS)	3.64	2.40	2.06	1.21	1.23	1.20	1.09	0.94	0.51	0.30
Industrial autoproduction CHP new (EU ETS)	0.00	0.00	0.00	0.19	1.05	1.92	2.11	2.23	2.42	1.92
Utility DHP existing (EU ETS)	6.22	5.55	4.61	3.46	2.15	0.75	0.80	2.22	2.35	2.95
Utility DHP new (EU ETS)	0.00	0.00	0.00	0.00	0.00	0.00	0.00	0.00	0.00	0.00

Table A12. Cont.

Specification	2015	2020	2025	2030	2035	2040	2045	2050	2055	2060
Total emissions (EU ETS)	142	126	118	97.4	68.7	50.0	21.5	12.4	11.6	11.2
Total emissions over all categories	148	131	128	124	96.2	78.2	50.2	36.6	35.2	34.6
Total emissions from utility PP and CHP	138	123	121	119	91.7	74.4	46.2	31.2	29.9	29.4

Appendix B

MARKet ALlocation (MARKAL) is a computer program for the development of mathematical optimization models that reflect the current and future technological structure of energy systems. It is aimed at an integrated assessment of the development of the energy sector in one area, e.g., a single country or in many geographically or economically separated and interconnected regions [29]. The model joined the family of tools supporting integrated planning of the development of energy systems in the early 1980s [55,56], as a result of the international cooperation within the ETSAP program financed by the International Energy Agency (IEA).

MARKAL makes it possible to build a model of economic “partial equilibrium” and is characterized by balancing the production and consumption of energy carriers and other goods and fixing their prices. The cost of producing an energy carrier or other goods affects the demand for these goods, and at the same time the demand for an energy carrier or other goods affects their price. Market equilibrium is achieved at a certain price, at which the consumer does not want to buy less than what they need, and no producer wants to produce more than their current capabilities. If the market equilibrium is achieved, either profit maximization or cost minimization is sought, and this approach was used in the MARKAL program [29].

The mathematical structure of the standard MARKAL model takes the form of an optimization problem based on linear programming. As a result of solving the optimization problem, the values of decision variables are obtained, which ensure the minimum cost of the energy system, while meeting the constraints on the set of solutions imposed on it in the form of equations containing the variables and parameters of the model. The key decision variables include: the amount of net attainable power in a given group of technologies, as well as the amount of annual energy production, characteristic for a given technology of production or processing of various energy carriers. The model solution, including the proposed investments in new power plants, combined heat and power plants, and heating plants, is considered optimal for the entire time perspective under consideration.

MARKAL is based on the idea of the reference energy system (RES), which connects primary energy resources with a final or useful energy demand through a network of energy technologies as well as primary, secondary, and final energy carriers. RES is the work of the analyst’s creative invention, and its structure depends on the purpose it sets for the model and the level of detail of the available data. The shape of the RES is, however, subject to certain limitations resulting from the specificity of the tool. Technologies reflected in the MARKAL model are divided into three groups: (1) “PRC—processes”; (2) “conversion technologies” (CON); (3) “demand devices” (DMDs). “Processes” are technologies involving energy transformation that output neither electricity nor heat, which in turn are produced by “conversion technologies”, consisting of subcategories, e.g., power plants, combined heat and power plants, and heating plants. Demand devices convert secondary or final energy into useful energy, i.e., heat for space heating, domestic hot water, district cooling for room air conditioning, etc. On the primary energy side, there are options for the supply or exchange of energy or other goods—Source ENergy Carrier Price (SRCENCP).

The optimization procedure balances the RES so that the demand is met in each considered planning period and in each subperiod of the year (season, time of day). The constraining equations and inequalities make it possible to take into account the availability of power in a defined time period, including forced and planned power outages, the ability

of various technologies to meet the peak power demand, the effect of “aging” of the power generation structure, the need to maintain basic power plants, and their share in covering the power demand at night.

The optimization criterion used in the MARKAL model consists in minimizing the net present value of the costs of the energy system operation, reflected in the model. Discounting takes place within a single planning period t , lasting J years, where the cash flows are brought back to the beginning of that period, and then this sum is discounted to the first year of analysis (base year) [29,57]:

$$z = \sum_{r=1}^R \sum_{t=1}^T [(1+d)^{J(1-t)} \sum_{j=1}^J (1+d)^{-j} K_{ann(r,t)}] \quad (A1)$$

where: z —value of the objective function equal to the net present value (NPV) of the energy system costs, mapped in the model [thous. €]; r , R —index and number of regions (geographic areas) mapped in the model; t , T —index and number of planning periods; j , J —index of the year and number of years in one planning period t ; $K_{ann(r,t)}$ —annual costs of the operation of the energy system in the region r , in the year included in the planning period t [thous. €/a]; d —general discount rate for the energy system, mapped in the model [1/a].

The method of calculating the annual costs of the energy system operation, used in the MARKAL model, is based on the classical theory of costs in the energy sector. Fuel costs are not included in the variable operating costs because fuels are part of the energy system and their supply chain to energy facilities can be described in terms of energy resources and energy conversion technologies. Therefore, these costs are recorded in items including the extraction, acquisition (e.g., biomass) and import of fuels, energy conversion (technologies), and the supply of fuel to a specific type of technology. In addition, environmental costs are included, which may include environmental charges or emission allowances, or both. Revenues from the sale of energy commodities or other goods outside the considered area (export) reduce the annual costs of the energy system in the MARKAL model, written using the following relationship:

$$K_{ann(r,t)} = \sum_{p=1}^P (K_{cap(r,t,p)} + K_{fixom(r,t,p)} + K_{varom(r,t,p)} + \sum_{e=1}^E K_{deliv(r,t,p,e)}) + \sum_{s \notin exp} K_{supp(r,t,s)} - \sum_{s \in exp} K_{supp(r,t,s)} + \sum_{v=1}^V K_{env(r,t,v)} \quad (A2)$$

where: p —technology set (1, 2, ..., p); e —energy carrier set (1, 2, ..., E); s —supply option set, characterized by three main features: source, energy carrier, and price level (imp —imports, exp —exports, min —mining, rnw —renewables extraction); v —environmental indicators set (pollutants, greenhouse gases, emission equivalents) (1, 2, ..., V); $K_{cap(r,t,p)}$ —capital costs related to energy technology p ; $K_{fixom(r,t,p)}$ —fixed operation and maintenance costs related to energy technology p ; $K_{varom(r,t,p)}$ —fixed operation and maintenance costs related to energy technology p ; $K_{deliv(r,t,p,e)}$ —delivery cost of energy carrier e to energy plant built in technology p ; $K_{supp(r,t,s)}$ —costs associated with supply option s ; $K_{env(r,t,v)}$ —environmental (emission) costs.

The expansion of the equation describing the stream of annual costs of the energy system operation was formulated as follows:

$$K_r(r,t) = \sum_{p=1}^P [r_{cap(r,p)} k_{inv(r,t,p)} \Delta P_n(r,t,p) + k_{fixom(r,t,p)} P_n(r,t,p) + (k_{varom(r,t,p)} + \sum_{e=1}^E q_{r,t,p,e} k_{deliv(r,t,p,e)}) \sum_{w=1}^W E_n(r,t,p,w) + \sum_{s \notin exp} \sum_{l=1}^L c_{supp(r,t,s,l)} Q_{r,t,s,l} - \sum_{s \in exp} \sum_{l=1}^L c_{supp(r,t,s,l)} Q_{r,t,s,l} + \sum_{v=1}^V k_{env(r,t,v)} G_{r,t,v}] \quad (A3)$$

where:

$$r_{cap(r,p)} = \frac{d_{r,p}(1 + d_{r,p})^{\lambda_{r,p}}}{(1 + d_{r,p})^{\lambda_{r,p}} - 1} \quad (A4)$$

where: w —set of time slices (subdivisions of the year) representing season and the time of the day (1, 2, ..., W); l —set of price levels of a commodity (energy carrier) (1, 2, ..., L); $r_{cap(r,p)}$ —capital recovery factor [1/a]; $k_{inv(r,t,p)}$ —specific investment cost related to installed capacity [thous. €/MW]; ΔP_n —net capacity addition [MW]; $k_{fixom(r,t,p)}$ —specific fixed operation and maintenance costs [thous. €/(MW · a)]; $P_{n(r,t,p)}$ —net capacity [MW]; $k_{varom(r,t,p)}$ —specific variable operation and maintenance costs [thous. €/T]; $E_{n(r,t,p,w)}$ —annual net energy production [T/a]; $k_{deliv(r,t,p,e)}$ —specific delivery cost of energy carrier e to energy plant built in technology p [thous. €/T]; $q_{r,t,p,e}$ —consumption of energy carrier e related to main technology output (electricity—power plants and CHP plants, heat—heat-only plants) [–]; $c_{supp(r,t,s,l)}$ —price level associated with supply option s [thous. €/T]; $Q_{r,t,s,l}$ —annual amount of energy (commodity) associated with supply option s ; $k_{env(r,t,v)}$ —cost of emission of pollutant v (or emission allowance) [thous. €/t]; $G_{r,t,v}$ —annual amount of emitted pollutant v [kt/a]; $d_{r,p}$ —technology-specific discount rate (if not specified, general discount rate of the energy system is applied) [1/a]; $\lambda_{r,p}$ —technical lifetime of a plant built in technology p [a].

The optimal solution, assuming the determination of decision variables at the minimum value of the objective function (Equation (A1)), is limited by typical constraints imposed on these variables:

$$\Delta P_{r,t,p} \geq 0, P_{r,t,p} \geq 0, E_{r,t,p,w} \geq 0, Q_{r,t,s,l} \geq 0, G_{r,t,v} \geq 0 \quad (A5)$$

In addition, the set of solutions is limited by linear dependencies describing, inter alia, the balance of energy carriers and goods as well as the power balance of energy facilities. The mathematical structure of the MARKAL model is complex and its discussion can be found in the documentation for this tool [29]. Additionally, the analyst can create their own equations, using the model variables and entering parameters and the value of the left hand side of the equation, in the MARKAL code defined as ADRATIO (ad hoc relationships). It is also possible to modify the source code of the program by creating new variables and equations, if necessary.

References

1. European Commission. Directive 2010/75/EU of the European Parliament and of the Council of 24 November 2010 on industrial emissions (integrated pollution prevention and control) (Recast). *Off. J. Eur. Union* **2010**, L334, 17–119.
2. European Commission. Directive 2009/29/EC of the European Parliament and of the Council of 23 April 2009 amending Directive 2003/87/EC so as to improve and extend the greenhouse gas emission allowance trading scheme of the Community. *Off. J. Eur. Union* **2009**, L140, 63–87.
3. European Commission. *Communication from the Commission: A Roadmap for Moving to a Competitive Low Carbon Economy in 2050 COM(2011) 112 Final*; European Commission: Brussels, Belgium, 2011.
4. European Commission. *Energy Roadmap 2050 COM(2011) 885 Final of 15 December 2011*; European Commission: Brussels, Belgium, 2012.
5. Lin, B.; Jia, Z. The impact of Emission Trading Scheme (ETS) and the choice of coverage industry in ETS: A case study in China. *Appl. Energy* **2017**, *205*, 1512–1527. [[CrossRef](#)]
6. Lin, B.; Jia, Z. Impact of quota decline scheme of emission trading in China: A dynamic recursive CGE model. *Energy* **2018**, *149*, 190–203. [[CrossRef](#)]
7. Zhang, L.; Li, Y.; Jia, Z. Impact of carbon allowance allocation on power industry in China's carbon trading market: Computable general equilibrium based analysis. *Appl. Energy* **2018**, *229*, 814–827. [[CrossRef](#)]
8. Malkowski, R.; Bucko, P.; Jaskolski, M.; Pawlicki, W.; Stoltmann, A. Simulation of the Dynamics of Renewable Energy Sources with Energy Storage Systems. In Proceedings of the 2018 15th International Conference on the European Energy Market (EEM), Lodz, Poland, 27–29 June 2018; IEEE: Łódź, Poland, 2018; pp. 1–5.
9. Małkowski, R.; Nieznański, J. Underfrequency Load Shedding: An Innovative Algorithm Based on Fuzzy Logic. *Energies* **2020**, *13*, 1456. [[CrossRef](#)]
10. Szultka, A.; Szultka, S.; Czapp, S.; Lubosny, Z.; Malkowski, R. Integrated Algorithm for Selecting the Location and Control of Energy Storage Units to Improve the Voltage Level in Distribution Grids. *Energies* **2020**, *13*, 6720. [[CrossRef](#)]

11. Małkowski, R.; Jaskólski, M.; Pawlicki, W. Operation of the Hybrid Photovoltaic-Battery System on the Electricity Market—Simulation, Real-Time Tests and Cost Analysis. *Energies* **2020**, *13*, 1402. [CrossRef]
12. Han, X.; Liang, Y.; Ai, Y.; Li, J. Economic Evaluation of a PV Combined Energy Storage Charging Station Based on Cost Estimation of Second-Use Batteries. *Energy* **2018**, *165*, 326–339. [CrossRef]
13. Lux, B.; Pfluger, B. A supply curve of electricity-based hydrogen in a decarbonized European energy system in 2050. *Appl. Energy* **2020**, *269*, 115011. [CrossRef]
14. PSE SA Polish Transmission System Operator Report on Polish Power System (In Polish: Raport 2020 KSE). Available online: <https://www.pse.pl/dane-systemowe/funkcjonowanie-kse/raporty-roczne-z-funkcjonowania-kse-za-rok/raporty-za-rok-2020> (accessed on 1 December 2021).
15. Walkowska, K.; Berent-Kowalska, G.; Peryt, S.; Dziedzina, K.; Jurgaś, A.; Kacprowska, J.; Gilecki, R.; Parciński, G.; Boczek-Gizińska, R.; Szymańska, M.; et al. *Gospodarka Paliwowo-Energetyczna w Latach 2019 i 2020 (Energy Statistics in 2019 and 2020)*; Szymańska, K., Luty, P., Eds.; Statistics Poland (GUS): Warsaw, Poland, 2020.
16. Jaskólski, M. Modelling long-term technological transition of Polish power system using MARKAL: Emission trade impact. *Energy Policy* **2016**, *97*, 365–377. [CrossRef]
17. Dagoumas, A.S.; Koltsaklis, N.E. Review of models for integrating renewable energy in the generation expansion planning. *Appl. Energy* **2019**, *242*, 1573–1587. [CrossRef]
18. Gaur, A.S.; Das, P.; Jain, A.; Bhakar, R.; Mathur, J. Long-term energy system planning considering short-term operational constraints. *Energy Strateg. Rev.* **2019**, *26*, 100383. [CrossRef]
19. Yu, Y.; Jin, Z.; Li, J.; Wu, Y.; Jia, L. An Air Pollutant Emission Reduction Path of China’s Power Industry. *Atmosphere* **2020**, *11*, 852. [CrossRef]
20. Sarica, K.; Tyner, W.E. Economic impacts of increased U.S. exports of natural gas: An energy system perspective. *Energies* **2016**, *9*, 401. [CrossRef]
21. Gardumi, F.; Welsch, M.; Howells, M.; Colombo, E. Representation of Balancing Options for Variable Renewables in Long-Term Energy System Models: An Application to OSeMOSYS. *Energies* **2019**, *12*, 2366. [CrossRef]
22. Löffler, K.; Hainsch, K.; Burandt, T.; Oei, P.-Y.; Kemfert, C.; von Hirschhausen, C. Designing a Model for the Global Energy System—GENESYS-MOD: An Application of the Open-Source Energy Modeling System (OSeMOSYS). *Energies* **2017**, *10*, 1468. [CrossRef]
23. Dreier, D.; Howells, M. OSeMOSYS-PuLP: A Stochastic Modeling Framework for Long-Term Energy Systems Modeling. *Energies* **2019**, *12*, 1382. [CrossRef]
24. Jaskólski, M. Application of MARKAL model to optimisation of electricity generation structure in Poland in the long-term time horizon Part I—concept of the model. *Acta Energ.* **2012**, *12*, 15–25.
25. Jaskólski, M. Application of MARKAL model to optimisation of electricity generation structure in Poland in the long term time horizon. Part II. Model and forecasts assumptions. *Acta Energ.* **2012**, *13*, 4–13.
26. Jaskólski, M.; Bućko, P. MARKAL long-term power generation scenarios for Poland—Concept of the model. *Rynek Energii* **2013**, *107*, 108–114.
27. Jaskólski, M. Optimization of Nuclear Power Share in the Structure of Electricity Production in Poland in Time Perspective by 2060. *Acta Energ.* **2014**, *20*, 55–60. [CrossRef]
28. Jaskólski, M.; Bućko, P. MARKAL long-term power generation scenarios for Poland: Increasing the share of renewable energy sources by 2040. *Rynek Energii* **2015**, *117*, 117–125.
29. Loulou, R.; Goldstein, G.; Noble, K. Documentation for the MARKAL Family of Models. Available online: http://www.iea-etsap.org/web/MrklDoc-I_StdMARKAL.pdf (accessed on 31 August 2015).
30. European Commission. *A Policy Framework for Climate and Energy in the Period from 2020 to 2030 COM(2014) 15 Final*; European Commission: Brussels, Belgium, 2014.
31. Kannan, R.; Strachan, N.; Pye, S.; Anandarajah, G.; Balta-Ozkan, N. UK MARKAL Model Documentation. Available online: <https://www.ucl.ac.uk/energy-models/models/uk-markal/uk-markal-documentation> (accessed on 12 October 2015).
32. International Energy Agency IEA-Investment Costs. Available online: <http://www.worldenergyoutlook.org/weomodel/investmentcosts/> (accessed on 4 April 2016).
33. Gerbelová, H.; Versteeg, P.; Ioakimidis, C.S.; Ferrão, P. The effect of retrofitting Portuguese fossil fuel power plants with CCS. *Appl. Energy* **2013**, *101*, 280–287. [CrossRef]
34. Wang, X.; Du, L. Study on carbon capture and storage (CCS) investment decision-making based on real options for China’s coal-fired power plants. *J. Clean Prod.* **2016**, *112*, 4123–4131. [CrossRef]
35. Wójcicki, A. CO2 Geological Storage Potential in Poland. Available online: <https://www.iea.org/media/workshops/2009/ccswarsaw/wojcicki.pdf> (accessed on 17 March 2016).
36. Polskie Sieci Elektroenergetyczne, S.A. Plan Rozwoju w Zakresie Zaspokojenia Obecnego i Przyszłego Zapotrzebowania na Energię Elektryczną na Lata 2010–2025 (Wyciąg). Available online: http://www.pse.pl/uploads/kontener/Plan_Rozwoju_2010_2025.pdf (accessed on 31 August 2015).
37. Agencja Rynku Energii. *Katalog Elektrowni i Elektrociepłowni Zawodowych. Stan na 31.12.2014*; Biczyski -Bicz, W., Wrońska, I., Eds.; Agencja Rynku Energii: Warszawa, Poland, 2015.

38. Agencja Rynku Energii. *Katalog Elektrociepłowni Przemysłowych. Stan na 31.12.2014*; Biczynski-Bicz, W., Wrońska, I., Eds.; Agencja Rynku Energii: Warszawa, Poland, 2015.
39. PSE SA Informacje o Zasobach Wytwórczych KSE (wg Stanu na 30.11.2020). Available online: <https://www.pse.pl/documents/20182/89a41169-b3e1-4ff4-8bff-ce89019297cd?safeargs=646f776e6c6f61643d74727565> (accessed on 1 March 2021).
40. Capros, P.; De Vita, A.; Tasios, N.; Papadopoulos, D.; Siskos, P.; Apostolaki, E.; Zampara, M.; Paroussos, L.; Fragiadakis, K.; Kouvartakakis, N.; et al. *EU Energy, Transport. and GHG Emissions. Trends to 2050. Reference Scenario 2013*; Publications Office of the European Union: Luxembourg, 2014.
41. Oxera. *Discount Rates for Low-Carbon and Renewable Generation Technologies*; Oxera Consulting Ltd.: Oxford, UK; Brussels, Belgium, 2011.
42. García-Gusano, D.; Espegren, K.; Lind, A.; Kirkengen, M. The role of the discount rates in energy systems optimisation models. *Renew. Sustain. Energy Rev.* **2016**, *59*, 56–72. [CrossRef]
43. International Energy Agency; Nuclear Energy Agency. *Projected Costs of Generating Electricity 2010*; OECD Publishing: Paris, France, 2010.
44. Agencja Rynku Energii Budowane i Planowane Elektrownie. Available online: <http://www.rynek-energii-elektrycznej.cire.pl/st,33,335,tr,145,0,0,0,0,budowane-i-planowane-elektrownie.html> (accessed on 6 March 2018).
45. Zakeri, B.; Syri, S. Electrical energy storage systems: A comparative life cycle cost analysis. *Renew. Sustain. Energy Rev.* **2015**, *42*, 569–596. [CrossRef]
46. Ahmad, S.; Tahar, R.M. Selection of renewable energy sources for sustainable development of electricity generation system using analytic hierarchy process: A case of Malaysia. *Renew. Energy* **2014**, *63*, 458–466. [CrossRef]
47. European Commission. *Commission Staff Working Paper. Impact Assessment. Energy Roadmap 2050*; COM(2011) 885 final (SEC(2011) 1566 final; SEC(2011) 1569 final); European Commission: Brussels, Belgium, 2011.
48. Ministerstwo Gospodarki. *Projekt Polityki Energetycznej Polski do 2050 Roku*; Warszawa, Poland, 2015. Available online: https://www.civitas.edu.pl/wp-content/uploads/2015/03/Securitologia_2_2016_105_118.pdf (accessed on 6 December 2021).
49. DECC. *Updated Short-Term Traded Carbon Values Used for UK Public Policy Appraisal*; Department of Energy & Climate Change: London, UK, 2015.
50. Główny Urząd Statystyczny Bank Danych Lokalnych. Available online: <https://bdl.stat.gov.pl/BDL/start> (accessed on 30 March 2018).
51. Główny Urząd Statystyczny Bank Danych Makroekonomicznych. Available online: <https://bdm.stat.gov.pl/> (accessed on 30 March 2018).
52. Ministerstwo Klimatu i Środowiska. *Polityka Energetyczna Polski do 2040 r. Załącznik do Uchwały nr 22/2021 z Dnia 2 Lutego 2021 r*; Ministerstwo Klimatu i Środowiska: Warszawa, Poland, 2021.
53. Sejm Rzeczypospolitej Polskiej. *Ustawa z Dnia 20 Maja 2016 r. o Inwestycjach w Zakresie Elektrowni Wiatrowych*; Dz. U. z 2016 r. poz. 961; Kancelaria Sejmu RP: Warszawa, Poland, 2016.
54. United Nations. *Paris Agreement*; United Nations, 2015. Available online: https://unfccc.int/sites/default/files/english_paris_agreement.pdf (accessed on 6 December 2021).
55. Egberts, G. MARKAL-Ein LP-Modell für die Internationale Energieagentur. *OR Spektrum* **1981**, *3*, 95–100. [CrossRef]
56. Fishbone, L.G.; Giesen, G.; Goldstein, G.A.; Hymmen, H.A.; Stocks, K.J.; Vos, H.; Wilde, D.; Zölcher, R.; Balzer, C.; Abilock, H. *User's Guide for MARKAL (BNL/KFA Version 2.0)*; Brookhaven National Laboratory: Upton, NY, USA, 1983.
57. Jaskólski, M. *Modelowanie Rozwoju Regionalnych Systemów Energetycznych ze Szczególnym Uwzględnieniem Bioenergii*; Politechnika Gdańska, Wydział Elektrotechniki i Automatyki: Gdańsk, Poland, 2006.