

1
2 **1 Modernized cathodic protection system for legs of the production rig –**
3
4 **2**
5 **3 evaluation during ten years of service.**

6
7
8 4 K. Zakowski^a, P. Iglinski^{b*}, J. Orlikowski^a, K. Darowicki^a, K. Domanska^b

9
10 5 ^a Gdansk University of Technology, Faculty of Chemistry, Department of Electrochemistry,
11
12 6 Corrosion and Materials Engineering, 11/12 Gabriela Narutowicza Street, 80-233 Gdansk,
13
14 7 Poland

15
16
17 8 *E-mail address:* krzysztof.zakowski@pg.edu.pl, juliusz.orlikowski@pg.edu.pl,
18
19 9 kazimierz.darowicki@pg.edu.pl

20
21
22 10 ^b LOTOS Petrobaltic S.A., Stary Dwor 9 Street, 80-758 Gdansk, Poland

23
24
25 11 *E-mail address:* piotr.iglinski@lotospetrobaltic.pl, kinga.domanska@lotospetrobaltic.pl

26
27 12 * Corresponding author, *E-mail address:* piotr.iglinski@lotospetrobaltic.pl
28
29
30 13

31
32 **14 ABSTRACT**

33
34
35 15 The modernization of cathodic protection system of the Baltic Beta platform legs is described.
36
37 16 It was that the sacrificial anodes cone-shaped groups were to be placed on the seabed at a
38
39 17 depth of 80 meters. The measurements results of cathodic protection effectiveness during its
40
41 18 ten-years operation are presented. The effectiveness was assessed based on the potential value
42
43 19 along the entire length of the legs from the sea surface to the seabed. The gained experience
44
45 20 indicates that use of sacrificial anode systems mounted on the seabed can be an effective form
46
47 21 of cathodic protection of offshore platforms legs. It is basically the only means of
48
49 22 anticorrosion protection in case of a platform not able to leave its location for renovation
50
51 23 works in a shipyard.
52
53
54
55
56
57 24

58
59 **25 Keywords:**
60
61
62
63
64
65

26 Gas and oil production rig

27 Sea platform

28 Corrosion

29 Cathodic protection

30 Sacrificial anode

31

32 1. Introduction

33

34 Gas and oil production rigs require effective and reliable corrosion protection, without
35 which the material degradation may lead to breakdowns or even disasters (Kiran, 2017;
36 Esaklul and Ahmed, 2009; Melchers, 2005; Wu, 2018). Such protection is achieved through
37 the combined use of protective coatings and cathodic protection. These technologies
38 complement each other: the better the barrier properties of coatings, the lower the demand for
39 cathodic protection current. The use of coatings drastically reduces the cathodic protection
40 current demand of the protection object and hence, the required sacrificial anode weight.

41 Cathodic protection of marine structures can be implemented using systems based on
42 sacrificial anodes (Szabo and Bakos, 2006a), systems with an external power source –
43 impressed current cathodic protection (Szabo and Bakos, 2006b) or by means of hybrid
44 systems combining the two technologies (Larsen, 2019; Hajigholami et al., 2017). Sacrificial
45 anodes designed to work in seawater environment are made of zinc- or aluminum-based
46 alloys. In the classic cathodic protection solutions, cores of anodes are welded to a protected
47 structure, and anodes are arranged so as to provide the protective potential on the entire
48 protected surface (Hartt et al., 2005; Lemieux and Hartt, 2006).

49 Cathodic protection of marine structures is a complex issue. There are no universal
50 solutions for protection systems of this kind. Each structure requires development of an

1
2
3
4
5
6
7
8
9
10
11
12
13
14
15
16
17
18
19
20
21
22
23
24
25
26
27
28
29
30
31
32
33
34
35
36
37
38
39
40
41
42
43
44
45
46
47
48
49
50
51
52
53
54
55
56
57
58
59
60
61
62
63
64
65
66
67
68
69
70
71
72
73
74
75

individual concept for protection implementation. To design a protective installation properly, it is necessary to recognize the corrosion hazards in the facility and estimate the demand for protective current, which is related to the preservation of protective properties of the coatings, seawater temperature (Hong et al., 2018), its oxygenation and salinity (Zakowski and Narozny, 2014), depth, colonization of the constructions by marine organisms (Jeffrey and Melchers, 2003; Liu and Cheng, 2017) and precipitation of calcareous deposits (Zamanzade, 2007; Zakowski, 2013).

During the retrofit of cathodic protection system of the Baltic Beta rig legs, an concept for application of sacrificial anode groups placed on the seabed has been developed (Zakowski, 2011). It was basically the only means of protection in case of a platform not able to leave its location for renovation works in a shipyard. Such solutions have already been used, but in shallow seas (Hartt, 2012; Yin et al., 2019; Rossi, 1998). Meanwhile, the depth of the sea at the workplace of the Baltic Beta rig is about 80 meters.

This publication discusses the main operating experience of the platform's cathodic protection system obtained during its ten-year operation.

1.1 Characteristics of the Baltic Beta production rig

The Dyvi Beta rig (nowadays known as the Baltic Beta) was built for the Norwegian company K / S DYVI DRILLING by the French company Compagnie Francaise d'Entreprises Metalliques (CFEM) at the Dunkirk shipyard in 1975–77 under the ETA Houston Texas license. In the first period of its operation, it was used for development of the Norwegian oil field EKOFISK. Later, it was bought by the Norwegian company Smedvig and used for various purposes, such as construction of a port structure in the area of the Adriatic Sea. In 1994, it was purchased by the Polish company Petrobaltic. Before starting its journey to the

1
2
3
4
5
6
7
8
9
10
11
12
13
14
15
16
17
18
19
20
21
22
23
24
25
26
27
28
29
30
31
32
33
34
35
36
37
38
39
40
41
42
43
44
45
46
47
48
49
50
51
52

76 Baltic Sea, the WEST BETA rig was put on a dry dock, where renovation was carried out
77 focusing mainly on the legs structure. Having moved the platform from the Mediterranean,
78 the Baltic Beta began working on the development of the Polish B3 oil field in the Baltic Sea.
79 Since 1995, the Baltic Beta continuously works on the same location. The depth of the Baltic
80 Sea in the area of the foundation of the oil producing rig is about 80 m.

81 The Baltic Beta rig extracts from beneath the bottom of the Baltic Sea oil, natural gas
82 and associated formation water. At first all three fluids are separated from each other, and
83 each one has its own destiny in a separate technological process. The system responsible for
84 this operations is called GEOSERVICE.

85 Oil is pumped true a underwater pipe line to a storech tanker ship moored near the rig.
86 Once the tanker has reached its capacity, it is sent onshore for discharge or a ship to ship
87 transfer operation is carried out, which allows for a constant production of oil.

88 Formation water is specially prepared, it is deoxygenated, cleared from oil, special
89 chemical are added to kill any bacteria that can contaminate the oil reservoir. All of the
90 produced formation water is pumped back to the oil reservoir by a set of electrically driven
91 plunger pumps by a system called OIL PLUS.

92 The block diagram of the gas processing systems on board Baltic Beta is shown in Fig.
93 1. The natural gas separated from the crude oil is used on board Baltic Beta in three basic
94 processes. The first and most important is the electrical energy production process which
95 powers the rig itself. This is achieved by a gas turbine driving an electrical generator which
96 covers all of the rig power demand. This system is shown in Fig. 2 with field number five-
97 B2G8. The second process is related with the injection of sea water. In this process a second
98 gas turbine is used to drive a centrifugal pump, which injects specially prepared sea water to
99 the oil reservoir in order to sustain the oil pressure at a constant level, this system is called
100 BHPS. The third process uses all of the gas which was not used in the first two processes

101 mentioned above. This remaining gas is dried, filtered and compressed in a four stage
 102 electrically driven piston gas compressor. All component of this system are located on the
 103 stern of Baltic Beta and are shown in Fig. 2 with field number one- SSG.

105 **Tab. 1.** Gas characteristics separated on Baltic Beta.

Components	Unit	Parameters values		
		Min. Value	Max. Value	Average Value
Gas density (at 0 ° C)	kg/m ³	0,904	1,14	1,015
Gas chemical composition:				
CH ₄	% volume	43,4	51,48	46,6
C ₂ H ₆	% volume	22,92	30,26	26,37
C ₃ H ₈	% volume	13,25	18,99	16,2
i-C ₄ H ₁₀	% volume	0,76	1,43	1,06
n-C ₄ H ₁₀	% volume	1,27	4,42	2,91
neo-C ₅ H ₁₂	% volume	traces	0,026	0,002
i-C ₅ H ₁₂	% volume	0,16	2,28	0,48
n-C ₅ H ₁₂	% volume	0,17	1,27	0,48
C ₆ H ₁₂	% volume	0,02	0,73	0,18
C ₇ H ₁₆	% volume	traces	0,251	0,058
ΣC ₅ +	% volume	0,364	3,046	1,196
N ₂	% volume	3,27	7,18	5,45
CO ₂	% volume	0,03	0,52	0,19
He	% volume	traces	0,05	0,031
H ₂	% volume	traces	0,002	traces
Gas calorific value	MJ/m ³	51,26	56,99	54,63

106

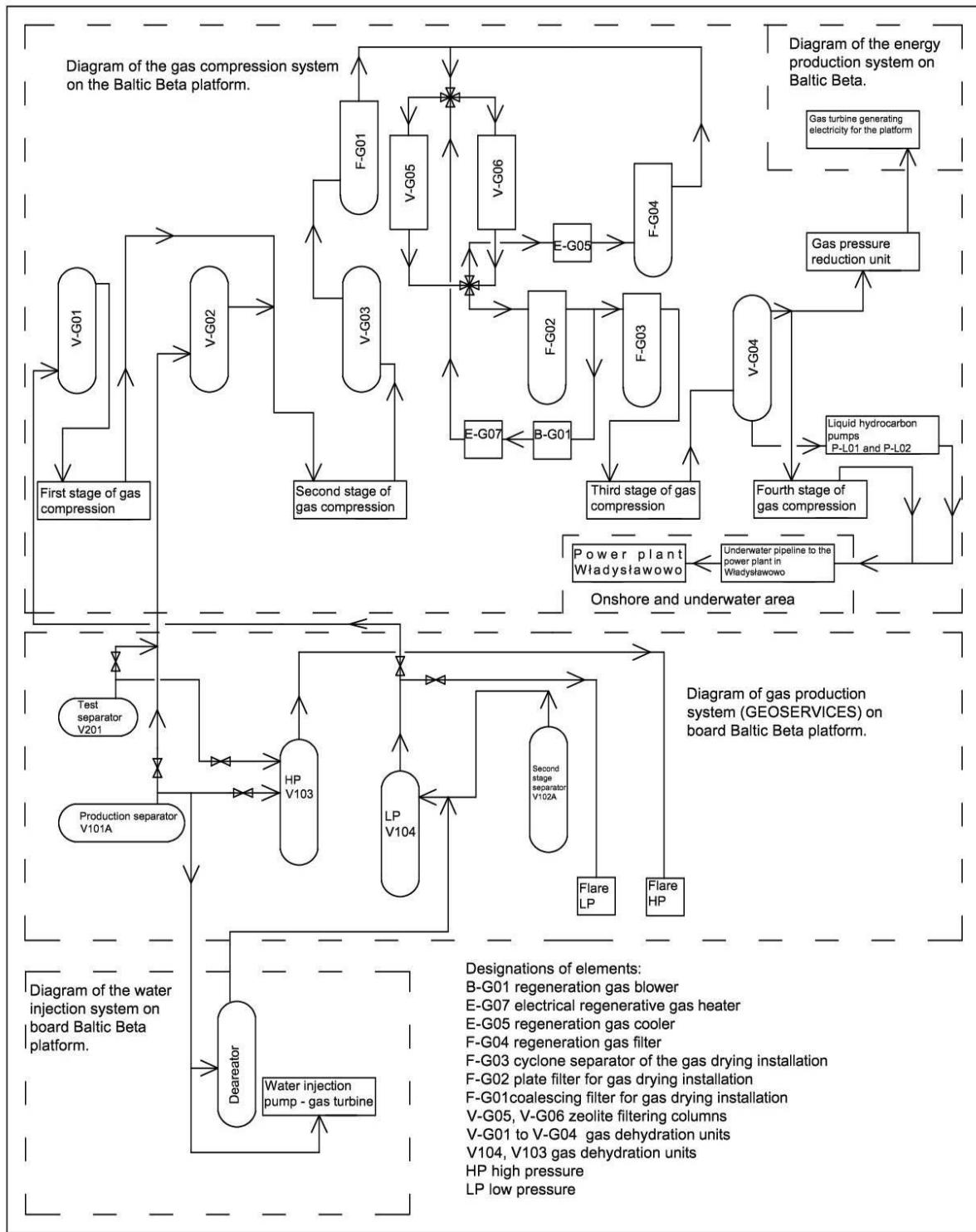

Fig. 1. Block diagram of the gas processing systems on board Baltic Beta.

1
2
3
4
5
6
7
8
9
10
11
12
13
14
15
16
17
18
19
20
21
22
23
24
25
26
27
28
29
30
31
32
33
34
35
36
37
38
39
40
41
42
43
44
45
46
47
48
49
50
51
107
108

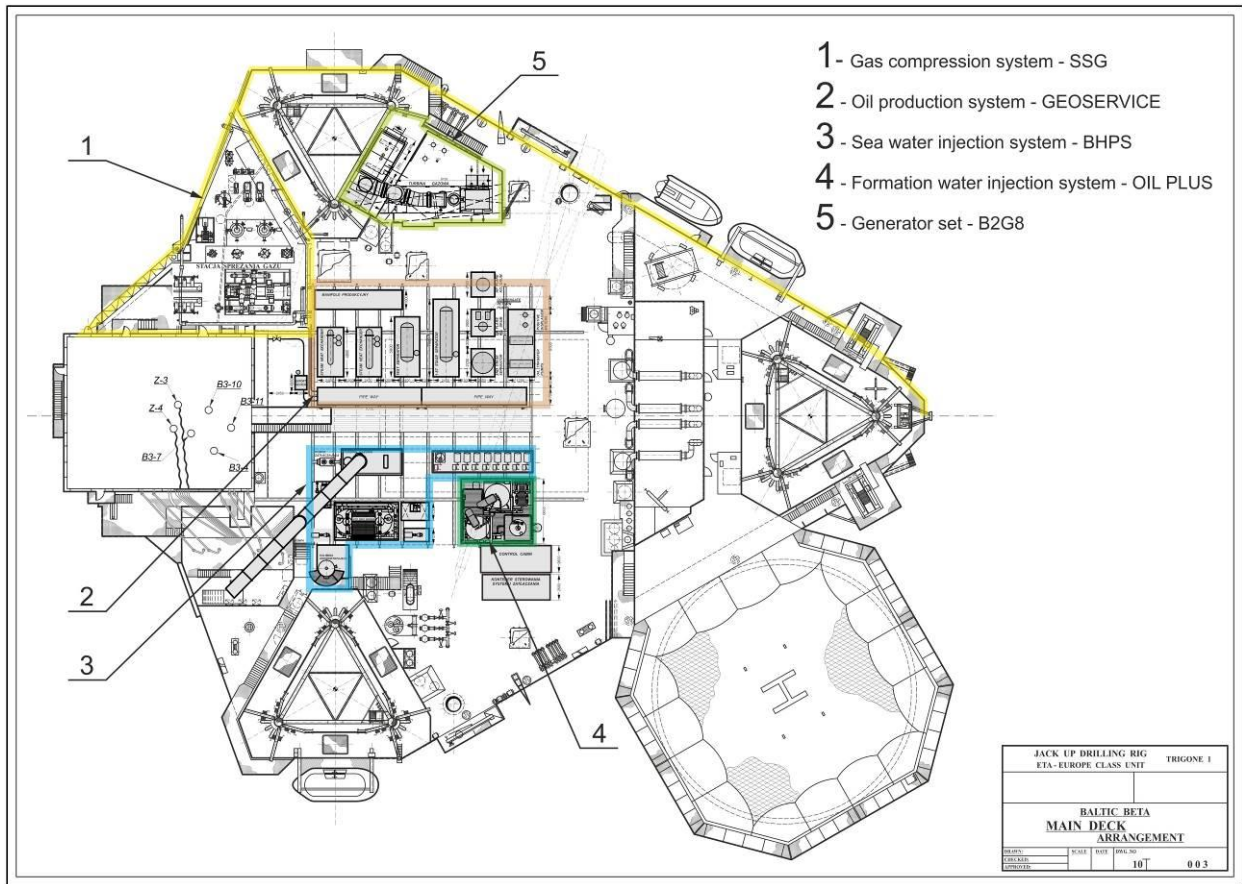
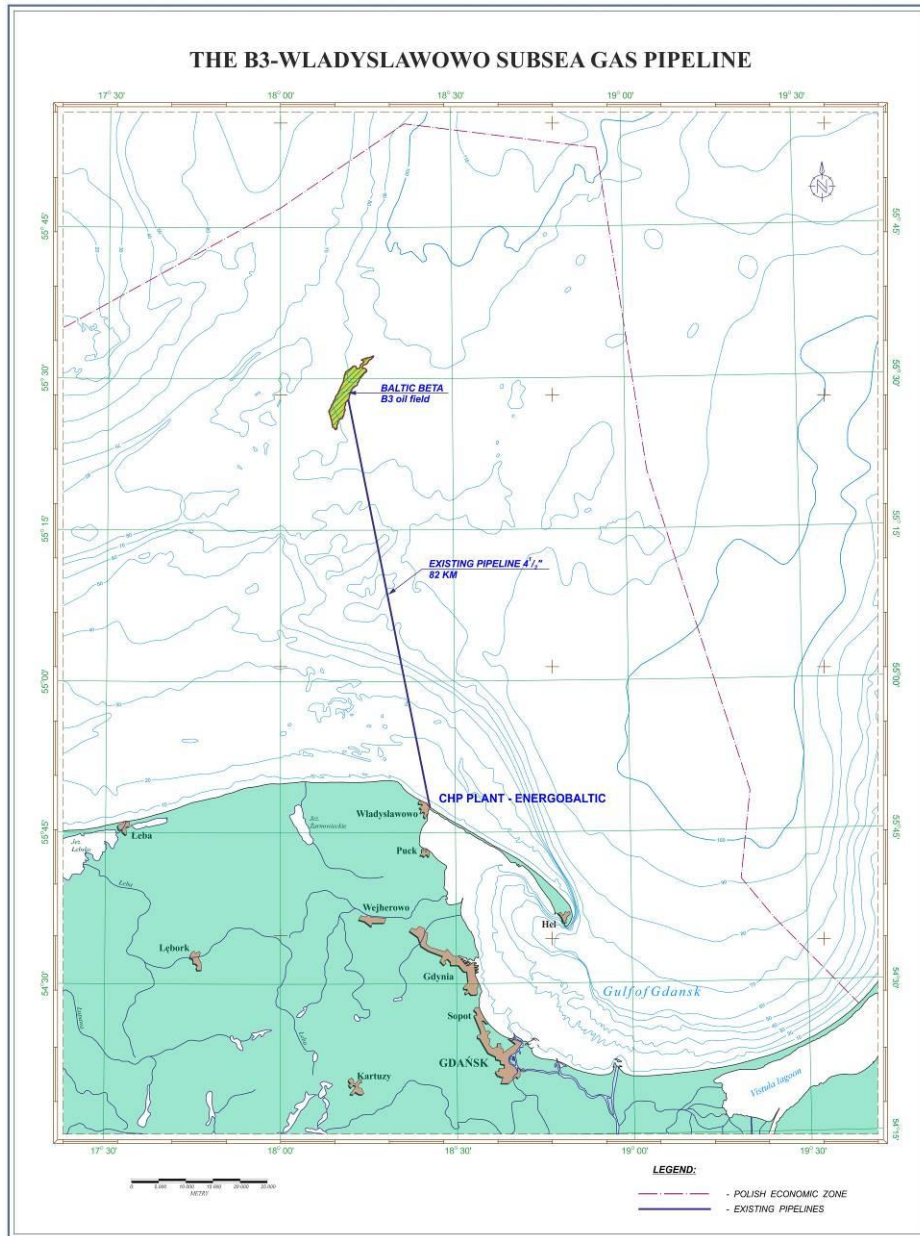

Fig. 2. Main deck arrangement of Baltic Beta with the indication of all five main systems.

After the process of drying and compressing, the so called dense phase gas, which is a suspension of hydrocarbons in dry gas, is transferred by the underwater pipeline to the gas separation station in the heat power plant in Wladyslawowo (Map. 1). The gas pipeline is 82.5 km long and its diameter is 115 mm (4 1/2 "). The pressure of the gas transferred by it reaches 13 MPa.



Map. 1. Map indicating the route of the gas pipeline on the seabed from the platform to the CHP plant onshore.

The production process in the heat power plant is divided into two stages. At the first stage, the heavy hydrocarbons fractions are separated from the gas supplied from the rig, in result of which the liquid propane – butane gas (LPG), natural gas condensate (KGN) and dry gas are obtained. At the second stage the dry gas is used for the production of heat and electrical energy.

125 The work of an oil and gas production rig is continuous by nature, which means that
126 the platform cannot leave the position where it had been originally founded. During
127 exploitation of the reservoir, the platform remains connected to underwater production and
128 water injection wells. In connection to the above, the renovated in the early nineties system of
129 sacrificial anodes welded to the legs and renewal of the rig legs paint coating were the only
130 applied means of the protection of the legs against corrosion.

131 To sum up, in 2019 the Baltic Beta platform will have ended 42 years of active
132 operation, 25 of which are continuous work on the Baltic B3 gas and oil field.

133

134 1.2 *Modernization of the cathodic protection system*

135
136 In 2008 there began work on a modernization project for the cathodic protection of the
137 legs. According to the standard DNVGL-RP-B401:2017 "Cathodic protection design",
138 cathodic protection current density for bare steel in seawater is a function of depth and
139 climatic region (based on surface water temperature). The platform works in a temperate
140 climatic region (water temperature 7-12 °C). Recommended in the standard DNVGL-RP-
141 B401 design current densities needed for the protection of bare steel are 100 mA/m² in depth
142 0-30 meters, and 80 mA/m² in depth 30-100 meters. Cathodic protection current demand is
143 lower when the structure is paint coated, therefore the design calculations of the current
144 densities take into account the thickness and age (wear) of the paint coating. This describes
145 the coating breakdown factor. The design current density is calculated by multiplying the
146 current density for bare steel by this factor. If the factor is equal to zero, then coating is
147 considered to provide full insulation, and if factor is equal to 1, coating has no protective
148 properties and the design current density is the same as for bare steel.

149 The submerged surface area of each of the three legs of the Baltic Beta platform that
1
2 150 requires protection is approximately 1800 m². In accordance with the design calculations
3
4 151 connected with the coating breakdown factor, the demand for cathodic protection current for
5
6
7 152 each leg of Baltic Beta platform totaled about 50 A.
8

9 153 The existing sacrificial anodes welded to the legs of the platform in 1995 turned out to
10
11 154 be used up in about 50%, which has been confirmed by a visual inspection of an underwater
12
13 155 vehicle (so-called ROV – remotely operated vehicle). As an additional source of cathodic
14
15 156 protection current, sacrificial anodes groups were designed in the form of cone-shaped baskets
16
17 157 (see Phot.1-3), two for each leg, which were to be placed on the seabed at the distance of
18
19 158 about dozen meters from the legs (Zakowski, 2011). The anode groups were electrically
20
21 159 connected to the legs with a cable. It was assumed that the anode systems should provide
22
23 160 protection current for the next 10 years, therefore each group contains 30 aluminum anodes,
24
25 161 1.5 meters long and 45 kg each.
26
27
28
29
30

31 162 Works related to mounting and connecting the anode groups were implemented in
32
33 163 September 2009. The task of placing the anode groups on the seabed required a cooperation
34
35 164 of tugboats, rig cranes and divers. The total time for assembly of the anode groups as well as
36
37 165 start-up of the installation was about one week. Photographs taken during the works in 2009
38
39 166 are included herein as Photos 1–3.
40
41
42
43
44
45
46
47
48
49
50
51



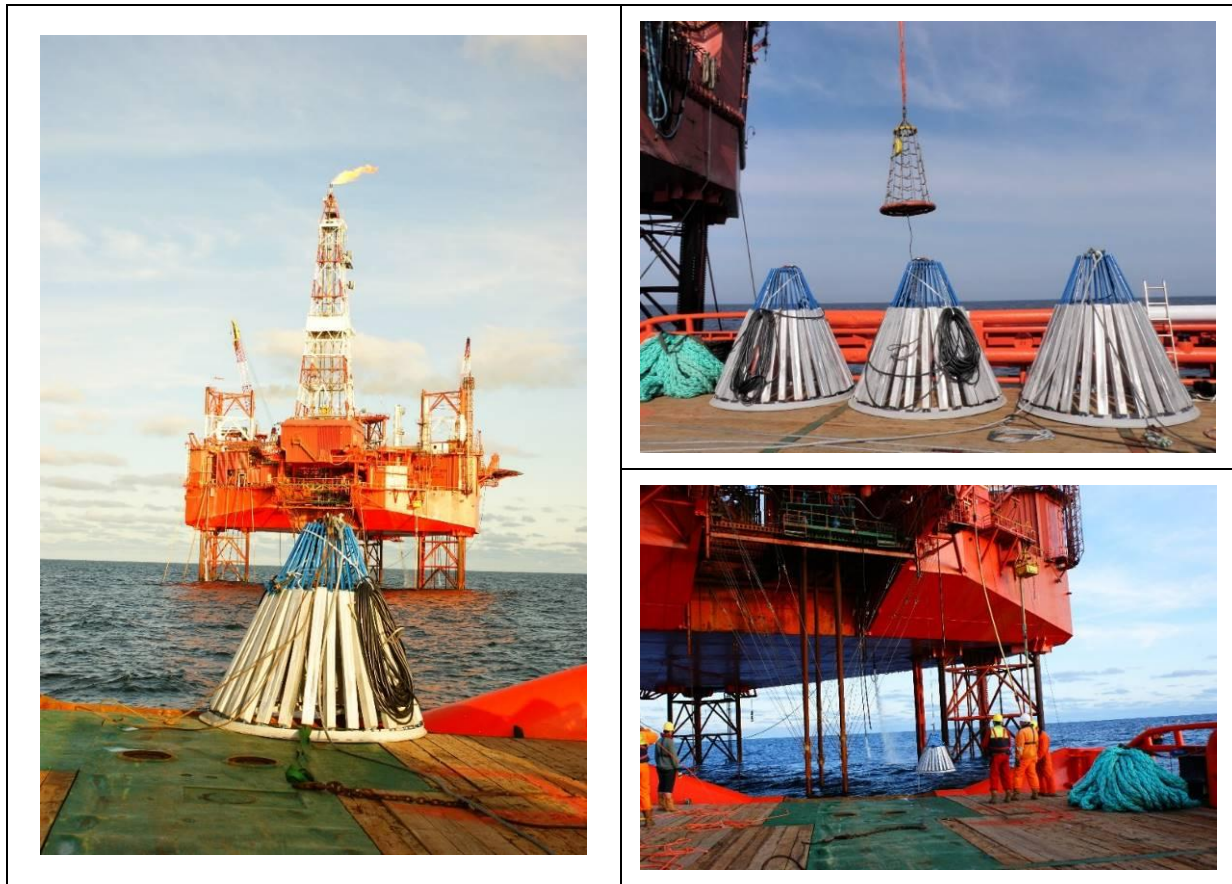

Photos 1–3. *The anode groups system installed during the modernization of cathodic protection system of the Baltic Beta sea platform.*

2. Methodology for assessing the effectiveness of the modernized cathodic protection system

Following modernization of the cathodic protection system, its effectiveness was assessed periodically based on measurements of the platform legs potential (Zakowski, 2011). The measurements were conducted in a way allowing to obtain the potential profiles of each leg over its entire height. The potentials were measured versus the zinc/seawater reference electrode, which was lowered on a measuring line along the entire length of the leg from the



181 sea surface to the seabed, as schematically shown in Figure 3. The results were recorded with
1
2
3
4
5
6
7
8
9
10
11
12
13
14
15
16
17
18
19
20
21
22
23
24
25
26
27
28
29
30
31
32
33
34
35
36
37
38
39
40
41
42
43
44
45
46
47
48
49
50
51
52
53
54
55
56
57
58
59
60
61
62
63
64
65
66
67
68
69
70
71
72
73
74
75
76
77
78
79
80
81
82
83
84
85
86
87
88
89
90
91
92
93
94
95
96
97
98
99
100
101
102
103
104
105
106
107
108
109
110
111
112
113
114
115
116
117
118
119
120
121
122
123
124
125
126
127
128
129
130
131
132
133
134
135
136
137
138
139
140
141
142
143
144
145
146
147
148
149
150
151
152
153
154
155
156
157
158
159
160
161
162
163
164
165
166
167
168
169
170
171
172
173
174
175
176
177
178
179
180
181
182
183
184
185
186
187
188
189
190
191
192
193
194
195
196
197
198
199
200
201
202
203
204
205
206
207
208
209
210
211
212
213
214
215
216
217
218
219
220
221
222
223
224
225
226
227
228
229
230
231
232
233
234
235
236
237
238
239
240
241
242
243
244
245
246
247
248
249
250
251
252
253
254
255
256
257
258
259
260
261
262
263
264
265
266
267
268
269
270
271
272
273
274
275
276
277
278
279
280
281
282
283
284
285
286
287
288
289
290
291
292
293
294
295
296
297
298
299
300
301
302
303
304
305
306
307
308
309
310
311
312
313
314
315
316
317
318
319
320
321
322
323
324
325
326
327
328
329
330
331
332
333
334
335
336
337
338
339
340
341
342
343
344
345
346
347
348
349
350
351
352
353
354
355
356
357
358
359
360
361
362
363
364
365
366
367
368
369
370
371
372
373
374
375
376
377
378
379
380
381
382
383
384
385
386
387
388
389
390
391
392
393
394
395
396
397
398
399
400
401
402
403
404
405
406
407
408
409
410
411
412
413
414
415
416
417
418
419
420
421
422
423
424
425
426
427
428
429
430
431
432
433
434
435
436
437
438
439
440
441
442
443
444
445
446
447
448
449
450
451
452
453
454
455
456
457
458
459
460
461
462
463
464
465
466
467
468
469
470
471
472
473
474
475
476
477
478
479
480
481
482
483
484
485
486
487
488
489
490
491
492
493
494
495
496
497
498
499
500
501
502
503
504
505
506
507
508
509
510
511
512
513
514
515
516
517
518
519
520
521
522
523
524
525
526
527
528
529
530
531
532
533
534
535
536
537
538
539
540
541
542
543
544
545
546
547
548
549
550
551
552
553
554
555
556
557
558
559
560
561
562
563
564
565
566
567
568
569
570
571
572
573
574
575
576
577
578
579
580
581
582
583
584
585
586
587
588
589
590
591
592
593
594
595
596
597
598
599
600
601
602
603
604
605
606
607
608
609
610
611
612
613
614
615
616
617
618
619
620
621
622
623
624
625
626
627
628
629
630
631
632
633
634
635
636
637
638
639
640
641
642
643
644
645
646
647
648
649
650
651
652
653
654
655
656
657
658
659
660
661
662
663
664
665
666
667
668
669
670
671
672
673
674
675
676
677
678
679
680
681
682
683
684
685
686
687
688
689
690
691
692
693
694
695
696
697
698
699
700
701
702
703
704
705
706
707
708
709
710
711
712
713
714
715
716
717
718
719
720
721
722
723
724
725
726
727
728
729
730
731
732
733
734
735
736
737
738
739
740
741
742
743
744
745
746
747
748
749
750
751
752
753
754
755
756
757
758
759
760
761
762
763
764
765
766
767
768
769
770
771
772
773
774
775
776
777
778
779
780
781
782
783
784
785
786
787
788
789
790
791
792
793
794
795
796
797
798
799
800
801
802
803
804
805
806
807
808
809
810
811
812
813
814
815
816
817
818
819
820
821
822
823
824
825
826
827
828
829
830
831
832
833
834
835
836
837
838
839
840
841
842
843
844
845
846
847
848
849
850
851
852
853
854
855
856
857
858
859
860
861
862
863
864
865
866
867
868
869
870
871
872
873
874
875
876
877
878
879
880
881
882
883
884
885
886
887
888
889
890
891
892
893
894
895
896
897
898
899
900
901
902
903
904
905
906
907
908
909
910
911
912
913
914
915
916
917
918
919
920
921
922
923
924
925
926
927
928
929
930
931
932
933
934
935
936
937
938
939
940
941
942
943
944
945
946
947
948
949
950
951
952
953
954
955
956
957
958
959
960
961
962
963
964
965
966
967
968
969
970
971
972
973
974
975
976
977
978
979
980
981
982
983
984
985
986
987
988
989
990
991
992
993
994
995
996
997
998
999
1000

182 the accuracy of 0.1 mV using a digital recorder.

183 The reference electrode was made of high purity zinc (99.99% of weight). It was made
184 in the shape of a cylinder with a diameter of 2.5 cm and a height of 5 cm. The cable
185 connection to the electrode was isolated against water ingress by a resin. The side surface of
186 the cylinder and the cable connection were secured with a heat-shrinkable polyethylene tube
187 with adhesive in such a way that only the base of the zinc cylinder had contact with the
188 electrolyte (sea water). Before the measurements, the potential of the zinc electrode was
189 checked versus a saturated calomel electrode (SCE). The value of the potential of the zinc
190 electrode versus SCE in 1 % NaCl solution was equal to -1020 ± 5 mV. Before measuring the
191 potential of the Baltic Beta platform legs, the zinc reference electrode was immersed in
192 seawater for 30 minutes to stabilize the electrode potential.

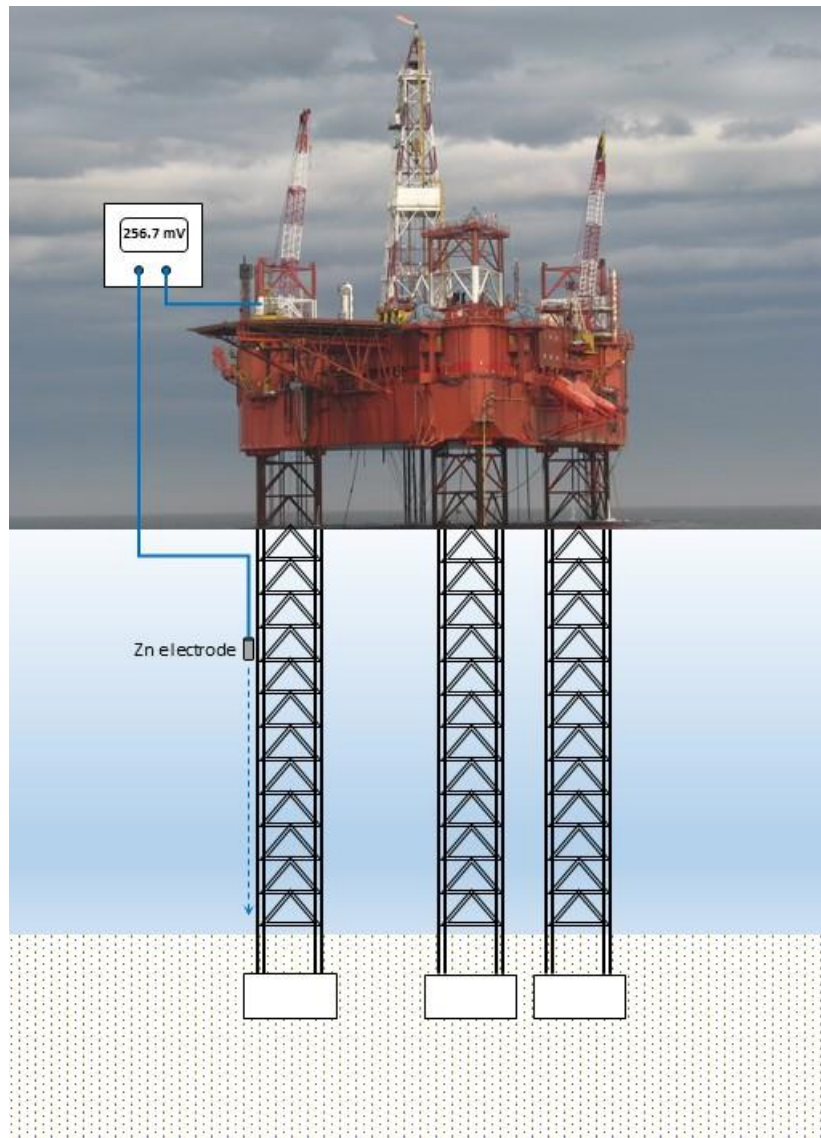

Fig. 3. A way to measure the potential profile of the platform leg.

Typical values of the potential of steel corroding in seawater are approximately +0.50 V versus the zinc reference electrode. A more electropositive potential indicates occurrence of intense corrosion of steel structures on the high seas. According to the standard EN 12473:2014-04 "General principles of cathodic protection in sea water", the protection potential of steel structures is between +0.25 V and -0.05 V vs. Zn electrode (so called full cathodic protection). Recognized engineering practice and some standards (e.g. EN 12954:2019-12 "General principles of cathodic protection of buried or immersed onshore

1
2
3
4
5
6
7
8
9
10
11
12
13
14
15
16
17
18
19
20
21
22
23
24
25
26
27
28
29
30
31
32
33
34
35
36
193
37
38
194
39
40
41
195
42
43
196
44
45
197
46
47
198
48
49
199
50
51
200
201
202
MOST WIEDZY
Pobrano z mostwiedzy.pl

metallic structures") indicate that the linear corrosion rate of the structure polarized to the protective potential is less than 0.01 mm/year – a wall thickness of the structure is reduced annually by 0.01 mm. Potential in the range between 0.25 V and 0.40 V versus Zn electrode indicates a partial cathodic protection of steel. In this state the corrosive processes are then limited, but not completely eliminated, and corrosion rate is greater than 0.01 mm/year.

3. Results and discussion

3.1. Effect obtained after installation of the new anode systems

The potential profiles of the leg on the bow of the rig, measured during the assembly of subsequent anode systems in 2009 are shown in Fig. 4. Before assembling the anode groups, the average value of the potential along the entire length of the leg was approximately 0.34 V versus Zn reference electrode (initial state – red dashed line in Fig. 4). A gradual increase in the size of cathodic polarization (i.e. gradual decreasing the value of the potential) on the subsequent days can be observed, which is associated with assembly of each new anode group. The potential change in relation to the potential from before assembly of the systems (the initial state) was about 100 mV in the lower leg, and about 80 mV in the upper part – see pink line in Fig. 4 (7th day). The potential of the lower part of the leg was 0.23 V and potential of the upper part of the leg was 0.25 V. The lower cathodic polarity of the upper part results from the greater distance from the anode group. It is visible in Fig. 4 that polarization to the protective potential, i.e. below 0.25 V, occurred along the entire length of the leg. So, the effect of effective corrosion protection was obtained.

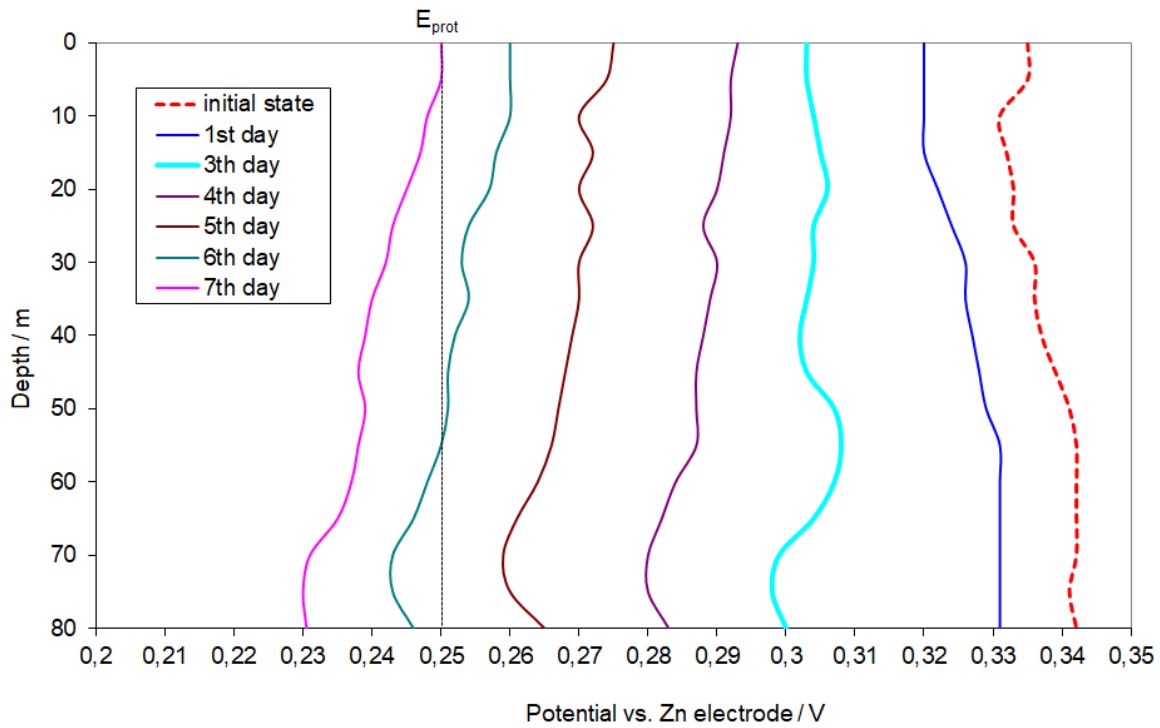

227
228 **Fig. 4.** An example of the potential profile of the platform leg during assembly and start-up of
229 the installation.

230
231 *3.2. Effect obtained during ten-year operation*

232
233 Fig. 5 and Fig. 6 provide examples of potential profiles obtained for the legs located
234 on the platform stern over 10 years of the cathodic protection system's operation.

235
236
237
238
239
240
241
242
243
244
245
246
247
248
249
250
251
Downloaded from mostwiedzy.pl

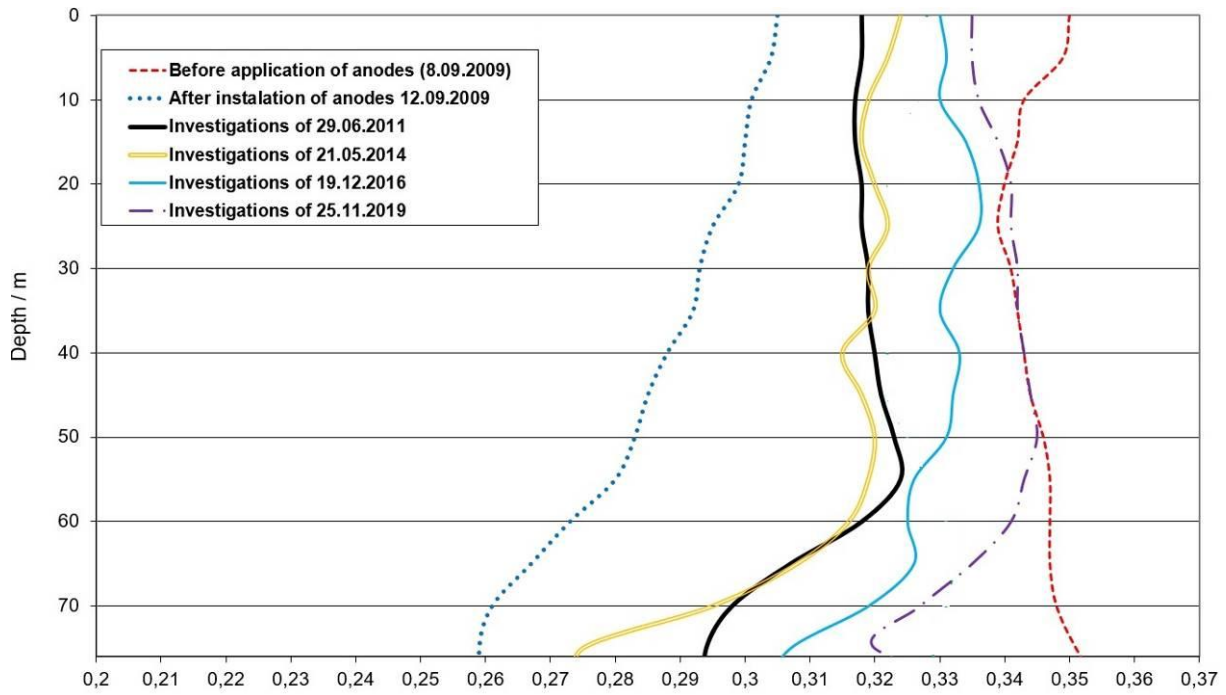

236
237 **Fig. 5.** Potential profiles of the leg located on the left side of the stern, obtained during ten-
238 year operation of the cathodic protection system.

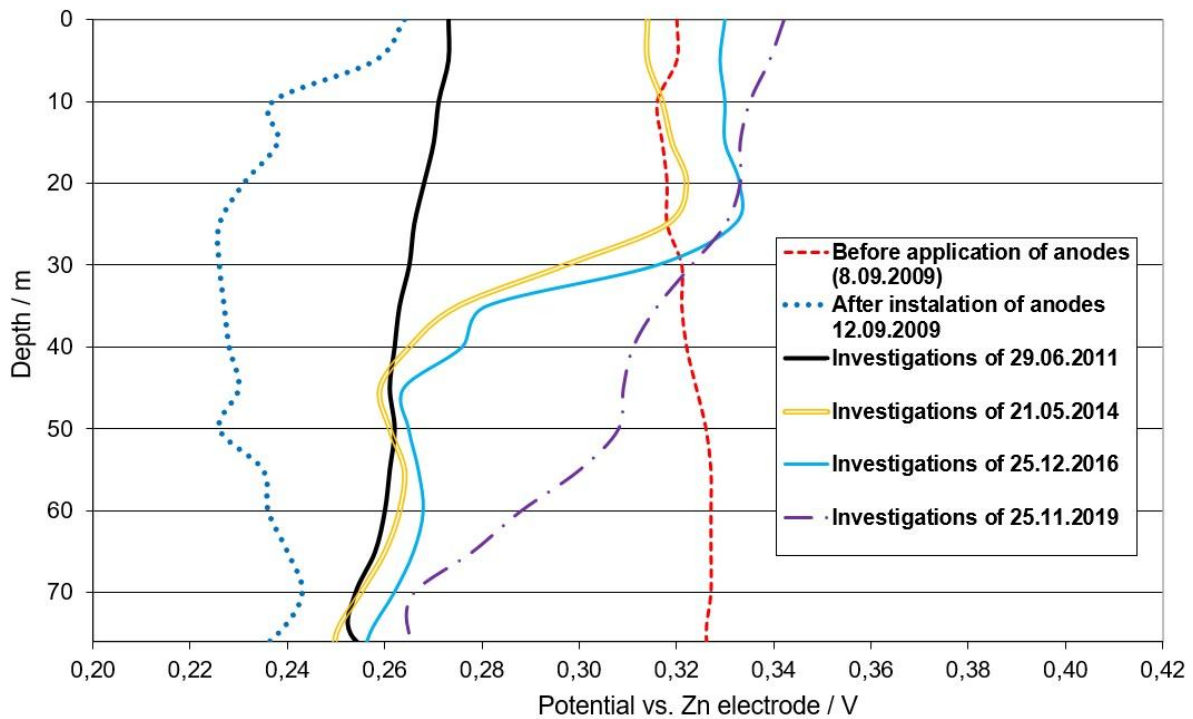

240
241 **Fig. 6.** Potential profiles of the leg located on the right side of the stern, obtained during ten-
242 year operation of the cathodic protection system.

243 In both figures the red dotted line shows the potential distribution over the entire
1
2 244 length of the legs in 2009 before applying new anodes. You can see that old, worn anodes
3
4 245 welded to the legs (in accordance with the original protection scheme developed for the
5
6
7 246 structure) did not provide enough current to polarize the legs to the potential of full cathodic
8
9
10 247 protection. The value of the potential over the entire length of the leg located on the left side
11
12 248 of the stern was in the range 0.34 - 0.35 V (see Fig. 5), and potential of the leg located on the
13
14 249 right side of the stern was 0.32 - 0.33 V versus Zn electrode (see Fig. 6).

16
17 250 After installation of a new anode systems in 2009, the potential of the left leg
18
19 251 decreased to 0.26 V at the bottom, and up to 0.3 V at the sea surface (blue dotted line in Fig.
20
21
22 252 5). The potential of the right leg was 0.24 V and 0.26 V, respectively (see Fig. 6).

23
24 253 In next years, there was a gradual deterioration in the cathodic polarization of the legs,
25
26 254 which progressed with dissolution of the anode material and degradation of the protective
27
28
29 255 coating over the years. At present, in November 2019, the system causes polarity of the left
30
31 256 stern leg to the potential approx. 0.32 V at the seabed, 0.34 V at a depth of 40 m, and 0.33 V
32
33
34 257 at the sea surface (see Fig. 5). For the right stern leg: 0.26 V by the seabed, 0.31 V at a depth
35
36 258 of 40 m, and 0.34 V at the sea surface (see Fig. 6). Thus, an effect of partial cathodic
37
38
39 259 protection of the legs is now obtained.

40
41 260 At the seabed, the potential of the leg located on the left side of the stern is more
42
43 261 negative (0.32 V – Fig. 5 investigation in November 2019) than the leg on the right side of the
44
45
46 262 stern (0.26 V – Fig. 6). This is due to the presence of bare, non-insulated steel casing pipes for
47
48
49 263 the oil and gas extraction system (risers). These pipes capture the cathodic protection current
50
51 264 flowing from the sacrificial anodes, which results in less current flowing to the platform legs.
265 The result is less cathodic polarization, so the potential is more positive.

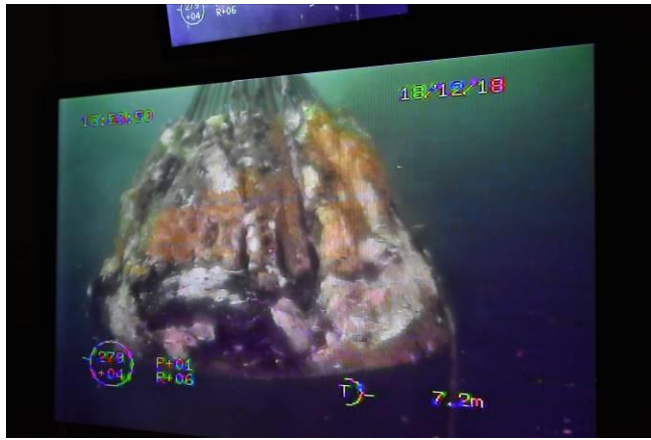

266
267 **Photos 4–9.** One of the cone-shaped anodes basket during a cleaning procedure carried out
268 at sea. The upper three photos show the cone before hydro-cleaning, and the lower three
269 photos show the cone after is cleaned.

270 Every time during potential measurements a close visual inspection of the anode
271 groups (cones) is carried out. These inspections indicated that all cones are working properly,
272 this is due to the fact that some products of aluminium alloy dissolution are overgrowing the
273 surface of the anodes. Such deposits can reduce the flow of protection current from the
274 anodes, this phenomenon is unwanted when it comes to corrosion protection. In order to
275 obtain the original operating parameters of the anodes, it is necessary to clean them of the
276 anode dissolution products. Due to their design, anode cones can be lifted and moved from the
277 seabed, this property has been useful several times before during their lifetime. This ability is
278 very useful and practical for any this type of objects when it comes to operating a platform at
279 sea. In 2018, a decision was made to recover the anodes cones for a cleaning operation.
280 Photos 4-9 show one of the cone during the cleaning process. Removing the overgrown
281 dissolution products was carried out by hydro-cleaning, all of the loose material was rinsed
282 off so that only the hard, unreacted protective alloy remained on the anodes. Information
283 gathered during each previous visual inspection, gave concerns about the amount of alloy left
284 on the anodes. After the cleaning process was finished it was clear that the amount of
285 protective alloy remaining on the anodes is about 50% of the original volume. After the
286 cleaning operation was completed, all of the cones were returned to their previous location on
287 the seabed.

288

289 **4. Conclusions**

290

291 After installation of sacrificial anode groups placed on the seabed, providing
292 complementary protection, the cathodic protection conditions of the platform legs improved
293 significantly. The potential of legs near the seabed was higher than the full protection criterion
294 by approx. 0.01–0.02 V, while closer to the sea surface (at a considerable distance from the

295 anodes) protection conditions were weaker (at the level of 0.04 V above the criterion value).
296 During operation of the system, deterioration of protection conditions could be observed
297 resulting mainly from dissolution of sacrificial anodes and progressing degradation of
298 protective coatings.

299 The experience gained during the ten-year operation of the cathodic protection system
300 indicates that use of sacrificial anode systems mounted on the seabed can be an effective form
301 of cathodic protection of offshore platforms legs. It is basically the only means of protection
302 in case of a platform not able to leave its location for renovation works in a shipyard. The
303 obtained measurement results indicate that sacrificial anode systems located on the seabed can
304 polarize platform legs even over a length of 80 meters.

305 Dissolution of sacrificial anodes means that a periodic assembly of new anodes is
306 necessary. The more degraded the protective coating gets over time, the higher the demand
307 for cathodic protection current, which further accelerates wear of the anode material. The
308 sacrificial anode groups installed on the seabed, anticipated for 10 years of operation, have
309 worn out. Therefore, currently work is underway on the next same renewal of the cathodic
310 protection system of the Baltic Beta platform legs. On the basis of experience presented in
311 this publication, it is planned also to use additional anodes welded to the legs at a depth of 0-
312 10 meters. They will provide a better cathodic polarization effect of the upper part of the legs
313 to ensure polarization to the full cathodic protection potential.

314 Funding: This work was supported by the Ministry of Science and Higher Education of the
315 Republic of Poland in the 'Implementation doctorate' programme.

316
317
318
319

320 **References**

- 1
2 321
3
4
5 322 Esaklul, K.A., Ahmed, T.M., 2009. Prevention of failures of high strength fasteners in use in
6
7 323 offshore and subsea applications. *Engineering Failure Analysis* 16 (4), 1195-1202.
8
9 324 Special Issue. <https://doi.org/10.1016/j.engfailanal.2008.07.012>
10
11 325 Hajjigholami M. et al., 2017. Modeling the Cathodic Protection System for a Marine Platform
13
14 326 Jacket. *Materials Performance* 56 (4), 34-38.
15
16 327 Hartt, W.H., 2012. Cathodic protection of offshore structures-history and current status.
18
19 328 *Corrosion* 68 (12), 1063-1075. <https://doi.org/10.5006/0010-9312-68.12.1063>
20
21 329 Hartt, W.H., Zhang, X., Chu, W., 2005. Issues associated with expiration of galvanic anodes
23
24 330 on marine structures. *Corrosion* 61 (11), 1035-1040. <https://doi.org/10.5006/1.3280619>
25
26 331 Hong, M.S., Hwang, J.H., Kim, J.H., 2018. Optimization of the Cathodic Protection Design in
27
28 332 Consideration of the Temperature Variation for Offshore Structures. *Corrosion* 74 (1),
29
30 333 123-133. <https://doi.org/10.5006/2492>
31
32
33 334 Jeffrey, R., Melchers, R.E., 2003. Bacteriological influence in the development of iron
35
36 335 sulphide species in marine immersion environments. *Corrosion Science* 45 (4), 693-714.
37
38 336 [https://doi.org/10.1016/S0010-938X\(02\)00147-6](https://doi.org/10.1016/S0010-938X(02)00147-6)
39
40 337 Kiran, R, Teodoriu, C. et al., 2017. Identification and evaluation of well integrity and causes
41
42 338 of failure of well integrity barriers (A review). *Journal of Natural Gas Science and*
43
44 339 *Engineering* 45, 511-526. <https://doi.org/10.1016/j.jngse.2017.05.009>
45
46
47 340 Larsen, K.R., 2019. Designing and Managing an Offshore Cathodic Protection System.
48
49 341 *Materials Performance* 58 (4), 26-30.
50
51 342 Lemieux, E., Hartt, W.H., 2006. Galvanic anode current and structure current demand
343
344 determination methods for offshore structures. *Corrosion* 62 (2), 162-173.
<https://doi.org/10.5006/1.3278261>

- 345 Liu, T., Cheng, Y.F., 2017. The influence of cathodic protection potential on the biofilm
1
2 346 formation and corrosion behaviour of an X70 steel pipeline in sulfate reducing bacteria
3
4 347 media. *Journal of Alloys and Compounds* 729, 180-188.
5
6 348 <https://doi.org/10.1016/j.jallcom.2017.09.181>
7
8
9 349 Melchers, R.E., 2005. The effect of corrosion on the structural reliability of steel offshore
10
11 350 structures. *Corrosion Science* 47, 2391–2410.
12
13 351 <https://doi.org/10.1016/j.corsci.2005.04.004>
14
15
16 352 Rossi, S., Deflorian, F., Fedrizzi, L. et al., 1998. Corrosion protection of offshore structures
17
18 353 for oil and gas extraction. *Metallurgia Italiana* 90 (2), 45-50.
19
20
21 354 Szabo, S., Bakos, I., 2006a. Cathodic Protection with Sacrificial Anodes. *Corrosion Reviews*
22
23 355 24 (3-4), 231–280. <https://doi.org/10.1515/CORRREV.2006.24.3-4.231>
24
25
26 356 Szabo, S., Bakos, I., 2006b. Impressed Current Cathodic Protection. *Corrosion Reviews* 24
27
28 357 (1-2), 39-62. <https://doi.org/10.1515/CORRREV.2006.24.1-2.39>
29
30
31 358 Wu, S., Zhang, L. et al., 2018. A leakage diagnosis testing model for gas wells with sustained
32
33 359 casing pressure from offshore platform. *Journal of Natural Gas Science and Engineering*
34
35 360 55, 276-287. <https://doi.org/10.1016/j.jngse.2018.05.006>
36
37
38 361 Yin, P., Liu, F. et al., 2019. Discussion on cathodic protection retrofit technical solution for a
39
40 362 jacket platform in the south china sea. *Corrosion and Protection* 40 (11), 856-860.
41
42 363 <https://doi.org/10.11973/fsyfh-201911014>
43
44
45 364 Zakowski, K., 2011. Studying the effectiveness of a modernized cathodic protection system
46
47 365 for an offshore platform, *Anti-Corrosion Methods and Materials* 58 (4), 167-172.
48
49 366 <https://doi.org/10.1108/00035591111148876>
50
51
367 Zakowski, K., Szocinski, M., Narozny, M., 2013. Study of the formation of calcareous
368 deposits on cathodically protected steel in Baltic sea water. *Anti-Corrosion Methods and*
369 *Materials* 60 (2), 95-99. <https://doi.org/10.1108/00035591311308065>

- 370 Zakowski, K., Narozny, M., 2014. Influence of water salinity on corrosion risk-the case of the
1
2 371 southern Baltic Sea coast. Environmental Monitoring and Assessment 186 (8), 4871-
3
4 372 4879. <https://doi.org/10.1007/s10661-014-3744-3>
5
6
7 373 Zamanzade, M., Shahrabi, T., Yazdian, A., 2007. Improvement of corrosion protection
8
9 374 properties of calcareous deposits on carbon steel by pulse cathodic protection in
10
11 375 artificial sea water. Anti-Corrosion Methods and Materials 54 (2), 74-81.
12
13 376 <https://doi.org/10.1108/00035590710733566>
14
15
16
17
18
19
20
21
22
23
24
25
26
27
28
29
30
31
32
33
34
35
36
37
38
39
40
41
42
43
44
45
46
47
48
49
50
51