

# New Methods for Location Service in the WCDMA System

JACEK STEFAŃSKI

Gdańsk University of Technology  
Department of Radiocommunication Systems and Networks  
ul. Narutowicza 11/12, 80-952 Gdańsk  
jstef@eti.pg.gda.pl

*Received 2008.01.10  
Authorized 2008.03.12*

New methods for a location service (LCS) in the Wideband Code Division Multiple Access (WCDMA) system are elaborated. These methods base on the observed time difference of arrival (OTDOA) algorithm. The classic OTDOA in the WCDMA system, to calculation of the geographical position of a mobile station (MS), needs a knowledge of relative time differences (RTDs) between base stations. In this reason, the LCS implementation is difficult and rather expensive. The proposed methods do not require RTDs. The elimination of the RTD parameters significantly simplifies the localization process in the 3G (3<sup>rd</sup> Generation) real-life cellular networks. The usefulness of the methods for location service implementation is analysed. The simulation model is outlined and simulation results of the proposed methods are presented. These results show that in the extremely bad conditions, i.e. in urban environment, the proposed algorithms fulfil the requirements for emergency calls from cellular phones in relation to accuracy of MS position calculation.

*Keywords:* location service, LCS, location based services, LBS, radio navigation, OTDOA

## 1. INTRODUCTION

The interest in mobile station positioning for cellular networks is rapidly growing. Many services are based on position information LBS (Location Based Services), for instance access to the databases including restaurant addresses, hotels and offices in the vicinity. For a network operator the location information can be used to select channels or for management of handover processes. One of the most important applications of location services is to automatically locate people who make emergency calls from their cellular phone.

To fulfil the requirements for emergency call service in the European Union or in the USA, the location service in cellular phone networks should be based on the observed time difference of arrival (OTDOA) between a MS and a minimum of three (one serving and two auxiliary) base

stations (BSs). Implementation of a location service in the WCDMA system, in the frequency division duplex (FDD) mode, is difficult and rather expensive due to asynchronous operation of the base stations in this system. As depicted in Fig. 1, the Universal Mobile Telecommunications System (UMTS) requires dedicated components to control positioning [1]. Base stations are equipped with an *associated* location measurement unit (LMU) that provides for timing synchronization with neighbouring base station. To prevent accurate measurements in a bad radio conditions, operators can alternatively establish *stand-alone* LMUs. In this context, the LCS in the WCDMA/FDD is based on the actual RTDs between base stations. Each RTD slowly changes with time. The rate of change depends on the frequency differences and jitters between BSs. Therefore, the measurements of this relatively slow rate of drift are needed using the LMUs. The measurement results are then stored in special databases which are later used for the calculation of MS position. The LMUs complicate positioning architecture in WCDMA/FDD system. When the RTD measurements to estimate the position of the MS are not needed, the location service is cheaper.

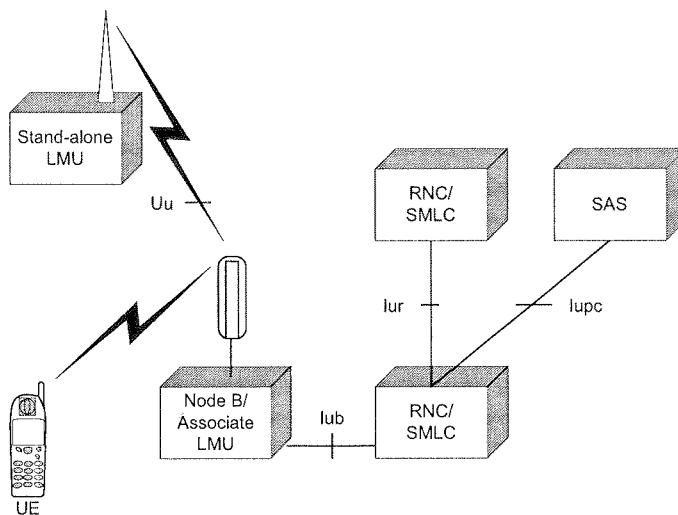

Fig. 1. UMTS positioning architecture. (LMU – location measurement unit; RNC – Radio Network Controller; SMLC – Serving Mobile Location Centre; SAS – Stand-alone SMLC; UE – User Equipment (mobile station);  $Uu$  – radio interface;  $Iub$ ,  $Iur$  and  $Iupc$  – telecommunications interfaces)

In this paper two methods, which enable the calculation of the geographical position of a mobile station without knowledge of relative time differences, are described. There are following methods:

- OTDOA+RTT-LMU, which is supported by round trip time (RTT) [2],
- OTDOA+IPDL-LMU, which is based on idle period downlink (IPDL) mode [3].

The new methods were tested in a finite microcellular environment with outdoor and indoor users – similar to Manhattan structure. The simulation investigations show that the estimation accuracy of the mobile station using the new methods is close to the classic one.

## 2. THE OTDOA+RTT-LMU METHOD

### 2.1. PROPOSED SOLUTION

The classic OTDOA method, in a two-dimensional plane, is reduced to a solution of the following set of non-linear equations [4]:

$$\begin{cases} c \cdot [t_1(n) - RTD_2 - t_2(n)] = \sqrt{[x_1 - x(n)]^2 + [y_1 - y(n)]^2} + \\ \quad - \sqrt{[x_2 - x(n)]^2 + [y_2 - y(n)]^2} \\ c \cdot [t_1(n) - RTD_3 - t_3(n)] = \sqrt{[x_1 - x(n)]^2 + [y_1 - y(n)]^2} + \\ \quad - \sqrt{[x_3 - x(n)]^2 + [y_3 - y(n)]^2} \end{cases} \quad (1)$$

where  $t_1(n)$ ,  $t_2(n)$  and  $t_3(n)$  denote the measured signal of transfer times from the BS<sub>1</sub>, BS<sub>2</sub> and BS<sub>3</sub> to the MS at the same discrete time  $n$ ,  $(x_1, y_1)$ ,  $(x_2, y_2)$  and  $(x_3, y_3)$  represent the co-ordinates of base stations,  $(x(n), y(n))$  are the co-ordinates of a mobile station at the discrete time  $n$ ,  $c$  is a speed of light and  $RTD_2$ ,  $RTD_3$  describe the relative time differences between serving BS<sub>1</sub> and auxiliaries BS<sub>2</sub> or BS<sub>3</sub>. However, the solution of this set of equations (1) is possible only when we know  $RTD_2$  and  $RTD_3$  (in the UMTS standard the  $RTD_2$  and  $RTD_3$  are measured in LMUs.). In connection with this, the second set of non-linear equations at the discrete time  $n+1$  is proposed (2):

$$\begin{cases} c \cdot [t_1(n+1) - RTD_2 - t_2(n+1)] = \\ \quad = \sqrt{[x_1 - x(n+1)]^2 + [y_1 - y(n+1)]^2} + \\ \quad - \sqrt{[x_2 - x(n+1)]^2 + [y_2 - y(n+1)]^2} \\ c \cdot [t_1(n+1) - RTD_3 - t_3(n+1)] = \\ \quad = \sqrt{[x_1 - x(n+1)]^2 + [y_1 - y(n+1)]^2} + \\ \quad - \sqrt{[x_3 - x(n+1)]^2 + [y_3 - y(n+1)]^2} \end{cases} \quad (2)$$

The relative time differences  $RTD_2$  and  $RTD_3$  are the constants at the discrete time  $n$  and  $n+1$ . By transforming the non-linear equations (1) and (2) respectively, we can get the new non-linear set of equations with six variables (3a):

$$\begin{cases} \sqrt{[x_1 - x(n)]^2 + [y_1 - y(n)]^2} - c \cdot t_1(n) = 0 \\ \sqrt{[x_2 - x(n)]^2 + [y_2 - y(n)]^2} - c \cdot [t_2(n) + RTD_2] = 0 \\ \sqrt{[x_3 - x(n)]^2 + [y_3 - y(n)]^2} - c \cdot [t_3(n) + RTD_3] = 0 \\ \sqrt{[x_1 - x(n+1)]^2 + [y_1 - y(n+1)]^2} - c \cdot t_1(n+1) = 0 \\ \sqrt{[x_2 - x(n+1)]^2 + [y_2 - y(n+1)]^2} - c \cdot [t_2(n+1) + RTD_2] = 0 \\ \sqrt{[x_3 - x(n+1)]^2 + [y_3 - y(n+1)]^2} - c \cdot [t_3(n+1) + RTD_3] = 0 \end{cases} \quad (3a)$$

or with four variables (3b):

$$\begin{cases} \sqrt{[x_1 - x(n)]^2 + [y_1 - y(n)]^2} - c \cdot t_1(n) = 0 \\ \sqrt{[x_1 - x(n+1)]^2 + [y_1 - y(n+1)]^2} - c \cdot t_1(n+1) = 0 \\ \sqrt{[x_2 - x(n+1)]^2 + [y_2 - y(n+1)]^2} + \\ - \sqrt{[x_2 - x(n)]^2 + [y_2 - y(n)]^2} - c \cdot [t_2(n+1) - t_2(n)] = 0 \\ \sqrt{[x_3 - x(n+1)]^2 + [y_3 - y(n+1)]^2} + \\ - \sqrt{[x_3 - x(n)]^2 + [y_3 - y(n)]^2} - c \cdot [t_3(n+1) - t_3(n)] = 0 \end{cases} \quad (3b)$$

These results can be used to calculate the geographical position of a mobile station without the knowledge of relative time differences. In the UMTS, the variables of  $t_i(n)$  and  $t_i(n+1)$  can be calculated by measuring the round trip times (RTTs), and the elements  $t_i(n)+RTD_i$  and  $t_i(n+1)+RTD_i$  (for  $i=2,3$ ) by measuring observed time differences in the system frame number SFN [5].

The solution of the above problem is shown in Fig. 2. As we can see, it is necessary to find the coordinates of a mobile station ( $(x(n), y(n))$  and  $(x(n+1), y(n+1))$ ). However, we must assume that we know:

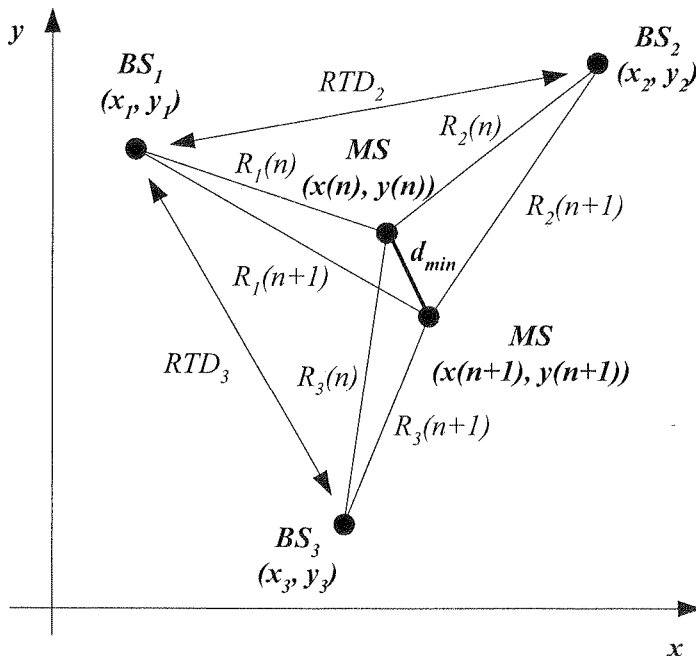

Fig. 2. The graphical illustration of the problem's solution. (MS – mobile station, BS – base station, RTD – relative time difference)

- the coordinates of  $BS_1$ ,  $BS_2$  and  $BS_3$ ,
- the distances between  $BS_1$  and the mobile station ( $R_1(n)$  and  $R_1(n+1)$ ),
- the distance differences between  $BS_2$ ,  $BS_3$  and mobile station ( $R_2(n+1) - R_2(n)$  and  $R_3(n+1) - R_3(n)$ ) at the discrete time  $n$  and  $n+1$ .

The distance,  $d_{min}$ , between two distinct positions of a mobile station at the discrete time  $n$  and  $n+1$ , depends on the resolution of the measured times of transition signals from BSs to MS. It is obvious that the smaller the  $d_{min}$  distance, the more useful is the new algorithm for the position estimation of a very slowly moving mobile station (uncertainty of 10 nanoseconds contributes to the 3 meter error in the position estimation).

## 2.2. CALCULATION OF A POSITION

The resulting relative time differences cause inaccuracies in the calculation of signal transit times and distances. As a result, the distances between  $BS_2$ ,  $BS_3$  and MS are measured, which are known as pseudo distances (PSDs). In this way, the pseudo distances at the discrete time  $n$  and  $n+1$  can be expressed as:

$$\begin{aligned}
 PSD_i(n) &= R_i(n) + c \cdot RTD_i \\
 R_i(n) &= \sqrt{[x_i - x(n)]^2 + [y_i - y(n)]^2} \\
 PSD_i(n+1) &= R_i(n+1) + c \cdot RTD_i \\
 R_i(n+1) &= \sqrt{[x_i - x(n+1)]^2 + [y_i - y(n+1)]^2}
 \end{aligned} \tag{4}$$

where  $R_i$  ( $i = 1, 2, 3$ ) is the real distance between  $BS_i$  and a mobile station,  $RTD_i$  equals zero. The solution of the non-linear equation (3) is difficult. One of the possible ways is the linearization of the equation on the basis of the Taylor-series expansion and then solving it iteratively [6]. In order to solve the set of equations (3), only the first part of the Taylor model is being exploited. After transforming all six equations, we can solve them according to the rules of a linear algebra:

$$\mathbf{g} = \mathbf{A}^{-1} \cdot \mathbf{d} \tag{5}$$

where

$$\mathbf{g} = \begin{bmatrix} \Delta x(n) \\ \Delta y(n) \\ \Delta x(n+1) \\ \Delta y(n+1) \\ RTD_2 \\ RTD_3 \end{bmatrix} \tag{6}$$

$$\mathbf{d} = \begin{bmatrix} PSD_1(n) - R_1(n) \\ PSD_2(n) - R_2(n) \\ PSD_3(n) - R_3(n) \\ PSD_1(n+1) - R_1(n+1) \\ PSD_2(n+1) - R_2(n+1) \\ PSD_3(n+1) - R_3(n+1) \end{bmatrix} \quad (7)$$

$$\mathbf{A} = \begin{bmatrix} \frac{x(n) - x_1}{R_1(n)} & \frac{y(n) - y_1}{R_1(n)} & 0 & 0 & 0 & 0 \\ \frac{x(n) - x_2}{R_2(n)} & \frac{y(n) - y_2}{R_2(n)} & 0 & 0 & c & 0 \\ \frac{x(n) - x_3}{R_3(n)} & \frac{y(n) - y_3}{R_3(n)} & 0 & 0 & 0 & c \\ 0 & 0 & \frac{x(n+1) - x_1}{R_1(n+1)} & \frac{y(n+1) - y_1}{R_1(n+1)} & 0 & 0 \\ 0 & 0 & \frac{x(n+1) - x_2}{R_2(n+1)} & \frac{y(n+1) - y_2}{R_2(n+1)} & c & 0 \\ 0 & 0 & \frac{x(n+1) - x_3}{R_3(n+1)} & \frac{y(n+1) - y_3}{R_3(n+1)} & 0 & c \end{bmatrix} \quad (8)$$

The unknown variables  $\Delta x(n)$ ,  $\Delta y(n)$ ,  $\Delta x(n+1)$ ,  $\Delta y(n+1)$  represent the estimation error. The values obtained from the solution of  $\Delta x(n)$ ,  $\Delta y(n)$ ,  $\Delta x(n+1)$ ,  $\Delta y(n+1)$  are used to recalculate the estimated position of  $x(n)$ ,  $y(n)$ ,  $x(n+1)$  and  $y(n+1)$  in accordance to the equations (9):

$$\begin{aligned} x_{new}(n) &= x_{old}(n) + \Delta x(n) \\ y_{new}(n) &= y_{old}(n) + \Delta y(n) \\ x_{new}(n+1) &= x_{old}(n+1) + \Delta x(n+1) \\ y_{new}(n+1) &= y_{old}(n+1) + \Delta y(n+1) \end{aligned} \quad (9)$$

The estimated values of  $x_{new}(n)$ ,  $y_{new}(n)$ ,  $x_{new}(n+1)$ , and  $y_{new}(n+1)$  can now be substituted into the set of equations (5) by applying the normal iterative process, until the error of components  $\Delta x(n)$ ,  $\Delta y(n)$ ,  $\Delta x(n+1)$ ,  $\Delta y(n+1)$  is smaller than the assumed one. As a result of simulation, depending on the initial estimation of parameters, three to five iterative calculations are generally required to obtain an error of the unknowns of less than 1 cm. The calculated values of  $RTD_2$  and  $RTD_3$  using the equation (5), correspond to the synchronization error of base station and they can be used to reduce the algorithm of a location service in the next steps of position calculations.

A  
differ  
asynch  
simpli

N  
far pro  
transm  
periods  
station  
same f  
period  
Fig. 3.

Fig. 3. Th  
measured  
differenc  
between  
between

### 3. THE OTDOA+IPDL-LMU METHOD

#### 3.1. PROPOSED SOLUTION

As we know, in the WCDMA/FDD system a mobile station measures observed time differences in the system frame number (SFN) for downlink. When the base stations work asynchronously and taken into account the expression (1), the MS measures (in this case, to simplify the notation a symbol of the discrete time,  $n$ , was omitted):

$$\begin{cases} t_{SFN1} = t_1 - t_2 - RTD_2 \Rightarrow t_1 - t_2 = t_{SFN1} + RTD_2 \\ t_{SFN2} = t_1 - t_3 - RTD_3 \Rightarrow t_1 - t_3 = t_{SFN2} + RTD_3 \end{cases} \quad (10)$$

Normally, in order to facilitate the OTDOA location measurements and to avoid near-far problems, the WCDMA/FDD standard includes idle periods in downlink, during which transmission of all channels from a base station is temporarily seized. A typical frequency of idle periods is 1 slot (about 667  $\mu$ s) every 100 ms, i.e. 0.7 % of the time [7]. In this respect the mobile station is able to receive the pilot signal of the neighbour cells even if the best pilot signal on the same frequency is very strong. For elimination of the relative time differences (RTDs), the idle period downlink mode is suggested. A graphical illustration of the proposed method is shown in Fig. 3. This method is based on finding time differences of the radio signal arrival between the

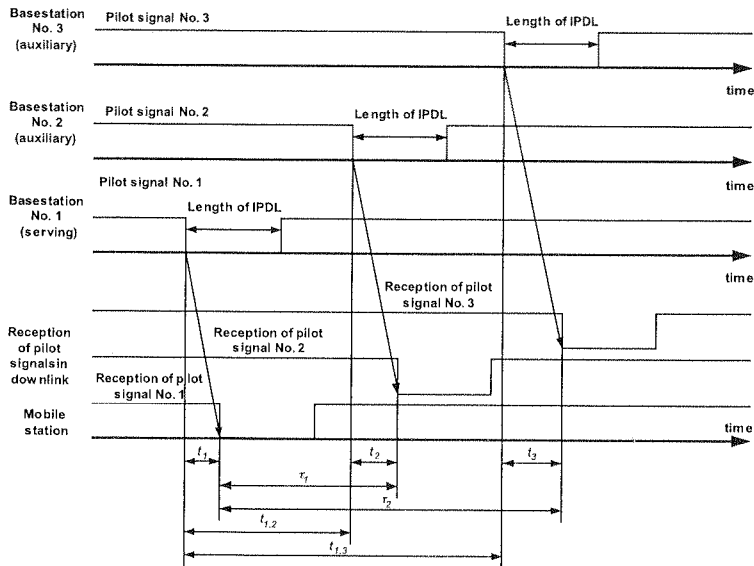

Fig. 3. The graphical illustration of the proposed method. ( $t_1$  – measured signal of transfer times from BS<sub>1</sub> to MS;  $t_2$  – measured signal of transfer times from BS<sub>2</sub> to MS;  $t_3$  – measured signal of transfer times from BS<sub>3</sub> to MS;  $\tau_1$  – time difference between moments of switch off of BS<sub>1</sub> transmission and BS<sub>2</sub> detected by mobile station;  $\tau_2$  – time difference between moments of switch off of BS<sub>1</sub> transmission and BS<sub>3</sub> detected by mobile station;  $t_{1,2}$  – real time difference between moments of switch off of BS<sub>1</sub> transmission and BS<sub>2</sub>;  $t_{1,3}$  – real time difference between moments of switch off of BS<sub>1</sub> transmission and BS<sub>3</sub>; IPDL – idle period downlink; BS – base station; MS – mobile station)

mobile station and base station No. 1 and No. 2, and between the mobile station and base station No. 1 and No. 3. For this purpose, the moments of switch off of pilot channel transmission can be used. In connection with this, according to Fig. 3, we can get the following expressions (11):

$$\begin{cases} t_1 - t_2 = t_{1,2} - \tau_1 \\ t_1 - t_3 = t_{1,3} - \tau_2 \end{cases} \quad (11)$$

where  $t_{1,2}$  and  $t_{1,3}$  represent the real time differences between moments of switch off BS<sub>1</sub> transmission and BS<sub>2</sub> or BS<sub>3</sub>,  $\tau_1$  and  $\tau_2$  denote the time difference between moments of switch off BS<sub>1</sub> transmission and BS<sub>2</sub> or BS<sub>3</sub> detected by a mobile station. In the WCDMA/FDD system all base stations work asynchronously, therefore the variables  $t_{1,2}$  and  $t_{1,3}$  can be expressed as:

$$\begin{cases} t_{1,2} = t_{per1} - RTD_2 \\ t_{1,3} = t_{per2} - RTD_3 \end{cases} \quad (12)$$

where  $t_{per1}$  and  $t_{per2}$  represent the theoretical time differences between moments of switch off of BS<sub>1</sub> transmission and BS<sub>2</sub> or BS<sub>3</sub>, when  $RTD_2$  and  $RTD_3$  equal zero. These variables can be calculated on the basis of the parameters sent to the mobile station via higher layers [7]. By transforming the equations (1) and (10) + (12), we can get the new non-linear set of equations with two variables (13):

$$\begin{cases} c \cdot \left( \frac{t_{SFN1} + t_{per1} - \tau_1}{2} \right) = \sqrt{(x_1 - x)^2 + (y_1 - y)^2} + \\ \quad - \sqrt{(x_2 - x)^2 + (y_2 - y)^2} \\ c \cdot \left( \frac{t_{SFN2} + t_{per2} - \tau_2}{2} \right) = \sqrt{(x_1 - x)^2 + (y_1 - y)^2} + \\ \quad - \sqrt{(x_3 - x)^2 + (y_3 - y)^2} \end{cases} \quad (13)$$

This method can be used to calculate the geographical position of a mobile station without knowledge of RTDs. The solution of the non-linear equation (13) is commonly known [4]. To sum up, the new method consists of:

- measurement of observed time differences of arrival between a mobile station and a minimum of three base stations (BS<sub>1</sub>, BS<sub>2</sub> and BS<sub>3</sub>) in the system frame number for downlink (classic method which is proposed to be implemented in WCDMA/FDD system) – measurement of  $t_{SFN1}$  and  $t_{SFN2}$ ,
- measurement of time differences between moments of switch off of pilot channel transmission for serving base station and BS<sub>2</sub> and BS<sub>3</sub> detected by mobile station during IPDL mode – measurement of  $\tau_1$  and  $\tau_2$ ,
- calculation of  $t_{per1}$  and  $t_{per2}$  variables using parameters which are sent to the mobile station via higher layers,
- the geographical position calculation of the mobile station using equations (13).



3.2. DETECTION OF SWITCH OFF OF BASE STATION TRANSMISSION

The detection of switch off of base station transmission is based on a matched filter correlator (MFC) [8], which is matched to the common pilot channel (CPICH). In the WCDMA, each radio frame consists of 38400 chips (10 ms) and is divided into 15 slots, i.e. 2560 chips per slot. The CPICH is scrambled by the primary downlink scrambling code of the cell. There are 10 pilot symbols within each time slot. The position in the radio frame and the length of idle period downlink mode is expressed in the number of CPICH symbols [7]. Therefore, according to Fig. 4, where the MFC output is presented, the moment of switch off of base station transmission can be measured.

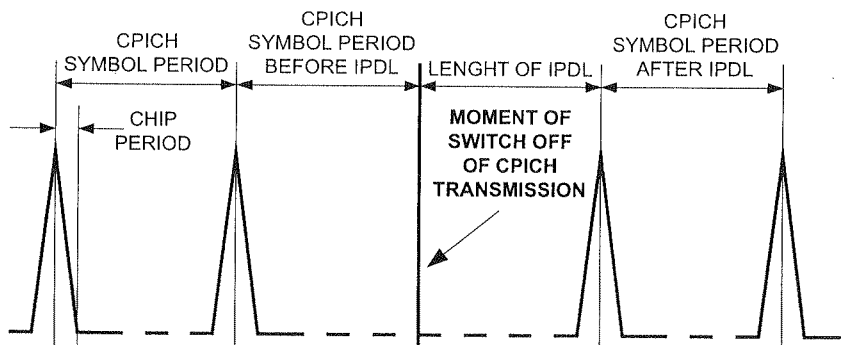

Fig. 4. The MFC output. (IPDL – idle period downlink; CPICH – common pilot channel)

To simplify our analysis, we can consider the single multipath situation where the receiver signal  $r(t)$  is given by [9]

$$r(t) = s(t) + as(t - D_0) + n(t), \quad 0 \leq t \leq T \tag{14}$$

where  $s(t)$  and  $n(t)$  are uncorrelated Gaussian random processes,  $a$  is an attenuation coefficient, and  $D_0$  is a multipath time delay. The autocorrelation function of  $r(t)$ ,  $R_r(D)$ , is

$$R_r(D) = \frac{1}{T} \int_0^T r(t)r(t-D)dt \tag{15}$$

Note that  $R_r(D)$  has a peak at  $D=0$  and peaks at  $D$  close to  $\pm D_0$ . The latter peaks may not be exactly at  $\pm D_0$  due to slight biases caused by the superposition of the various correlograms. We can now determine the error performance (variance) of the multipath time delay estimate via autocorrelation, i.e. we estimate the location of the peak near  $D_0$  by finding where  $R_r(D)/dD$  is equal to zero in the vicinity of  $D_0$ ; we call this point  $\hat{D}$ . A useful approximate result for  $\text{var}[\hat{D}]$  can be found if we assume that  $s(t)$  and  $n(t)$  have uniform, low pass spectra in the band  $|f| \leq B/2$ . For highly resolvable multipath ( $BD_0 \gg 1$ ), large observation time with respect to multipath delay ( $T/D_0 \gg 1$ ), and  $BT \gg 1$  we find [9]:

$$\text{var}[\hat{D}] \cong \frac{1}{BT} \frac{3}{\pi^2 B^2} \frac{[(1+a^2)^2 + a^2]S^2 + 2(1+a^2)SN + N^2}{a^2 S^2} \quad (16)$$

where  $S$  and  $N$  are the spectrum levels of  $s(t)$  and  $n(t)$ .

In Fig. 5, we show estimation variance (normalized by  $T^2$ ) versus SNR (Signal to Noise Ratio) for the autocorrelator. The CPICH has a fixed rate (30 kbps, SF=256 – Spreading Factor), hence  $T=33.3\mu\text{s}$  and  $B=5\text{MHz}$ . Additionally, we assumed that  $D_0$  is equal to  $2.3\mu\text{s}$  – the mean value for typical urban environment, and  $a=1$ . The above analyses can be used to the error of switch off of pilot channel transmission detected by the mobile station.

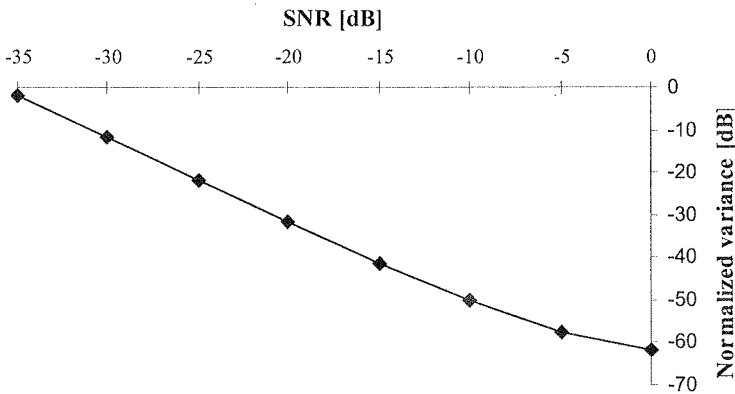

Fig. 5. Normalized variance versus SNR. ( $T=33.3\mu\text{s}$ ;  $D_0=2.3\mu\text{s}$ ;  $B=5\text{MHz}$ ;  $BT=167$ ;  $BD_0=11.3$ ;  $T/D_0=14$ ;  $a=1$ )

## 4. SIMULATION INVESTIGATIONS

### 4.1. SIMULATION MODEL

The experiments were carried out using the simulation model required for the UMTS [10]. This is a typical bad urban environmental model (Manhattan model). The area consisted of 12 by 11 blocks with a total number of 72 base stations. The street width was 30 m and the distance between two street corners was 230 m (see Fig. 6). Base station antennas were placed 10 m above the mobile users but below rooftops. The mobile station was located outdoor (25% of simulation time) and indoor (75% of simulation time). In our implementation, we covered the simulation area with a regular grid with resolution of 10 m. In the simulation model, the effect of a multipath propagation was implemented. The time of radio signal arrival between the mobile station and base stations under the multipath environment was modelled by the sum of true value  $\tau_0$  and non-line of sight (NLOS) error  $\tau_m$  [11]

$$\tau = \tau_0 + \tau_m \quad (17)$$

The variable  $\tau_m$  is defined as mean excess delay and essentially correlated with the root mean squared delay spread  $\tau_{rms}$  [12]

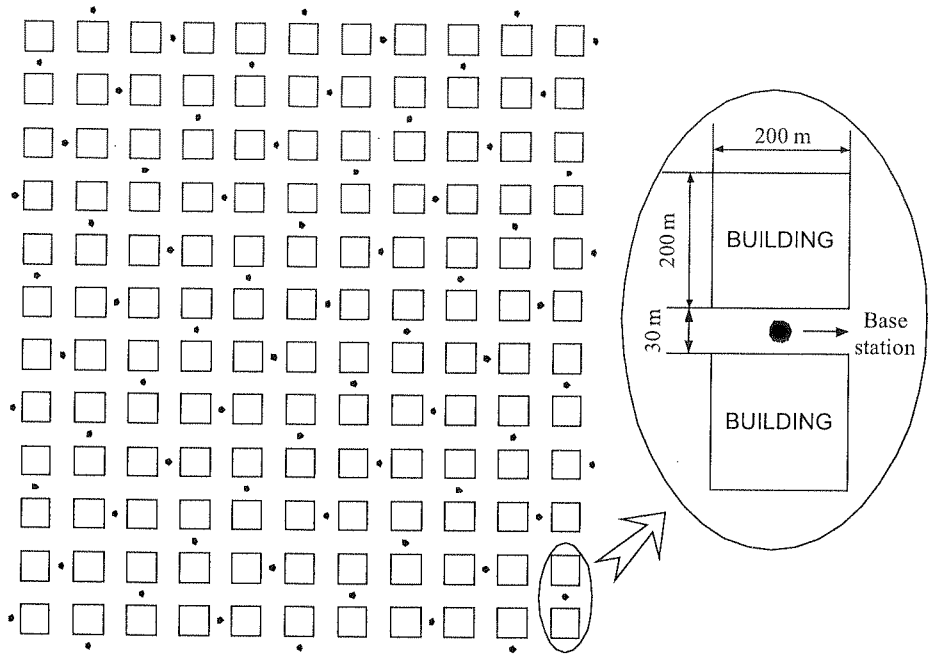

Fig. 6. Simulation model of the bad urban environment (Manhattan model)

$$\tau_m \approx k \cdot \tau_{rms} = k \cdot T_f \cdot d^\epsilon \cdot y \tag{18}$$

where  $k$  is a constant proportional coefficient ( $k=1$  in urban region),  $T_f$  is the median value of  $\tau_{rms}$  at  $d=1\text{km}$  (for urban environment  $T_f=0.7\mu\text{s}$ ),  $d$  is the distance between the mobile station and base station,  $\epsilon$  is an exponent (for urban environment  $\epsilon=0.5$ ) and  $y$  is a lognormal variate. Specifically,  $Y=10\log y$  is a Gaussian random variable over the terrain at the distance  $d$ , having zero mean and a standard deviation  $\sigma_y$  (for urban environment  $\sigma_y=4\text{dB}$ ).

#### 4.2. SIMULATION RESULTS

The cumulative probability distribution functions (CDF) of the absolute position error were obtained from the simulation investigations. The absolute position error is defined as

$$\Delta d = \sqrt{(x - x_0)^2 + (y - y_0)^2} \tag{19}$$

where  $x$  and  $y$  represent the real coordinates of a mobile station and  $x_0$  and  $y_0$  denote the estimated coordinates of a mobile station. All timing values have been assumed to be accurate within  $\pm 1/4$  of a WCDMA chip (the uniform random time error corresponds to a maximum distance error of about  $\pm 19$  m). Additionally for the second method, the error of switch off of pilot channel transmission detected by the mobile station was determined from (16) for two SNR values: -15dB and -20dB.

The simulation results are presented in Fig. 7. The proposed methods (OTDOA+RTT-LMU and OTDOA+IPDL-LMU) were compared with the classical OTDOA method. Our investigation show that all methods in the analysed environment (bad urban) fulfil the US E911 phase II requirements of positioned emergency calls within 125m in 67% of the time [13]. In the classic OTDOA method calls from cellular phones were located within 125m in 75.7% of the time. In the OTDOA+RTT-LMU method cellular phones were located within 125m in 67.7% of the time. In the last method OTDOA+IPDL-LMU, when the SNR decreases, the mobile station was located within 125m in 69.5% (SNR=-15dB) and 41.9% (SNR=-20dB) of the time. When the moment of switch off of pilot channel transmission detected by the mobile station reaches the ideal, for high SNR, the CDF of the proposed OTDOA+IPDL-LMU method converges to the classical one.

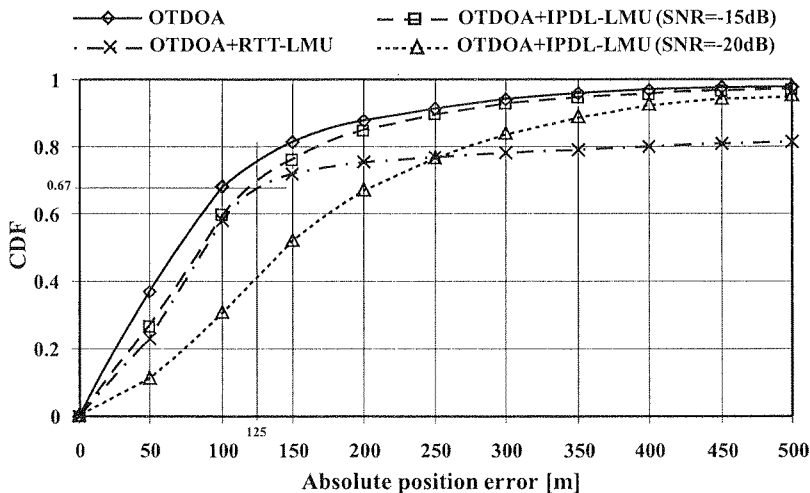

Fig. 7. The CDFs of absolute position error for the classical OTDOA and proposed methods. (CDF – cumulative probability distribution function; OTDOA – observed time difference of arrival; OTDOA+RTT-LMU and OTDOA+IPDL-LMU – OTDOA methods without using location measurement unit; SNR – Signal to Noise Ratio)

All simulation investigation was carried out in the bad urban environment, where a multipath propagation effect is very intensive. In other environments, i.e. urban area or rural area, the US E911 phase II requirements for emergency calls in relation to MS position will be fulfilled in excess.

Even though the proposed methods are worse than the conventional one with respect to the location estimation of a MS, they significantly simplify the localization process in the WCDMA/FDD system.

## 5. CONCLUSIONS

A new approach for the location service in the WCDMA/FDD system are proposed. As a result, the new techniques of calculation of the geographical position of a MS without

Vo  
the  
pr  
ph  
cal  
net  
ini  
 $n+$   
tra  
ext  
mo  
zer  
and  
hav  
pre  
off  
cha  
[15  
ava  
mod  
the  
  
very  
obta  
exer  
  
1. A. I  
2. J. S  
Cor  
3. J. S  
Dif  
4. Y.T  
Proc  
5. 3G  
(FD  
6. W.F  
Mar  
7. 3G  
(FD  
8. W.H  
tion  
pp. 7  
9. J.P.  
Acc

the knowledge of relative time differences are proposed. The complexity of localization processes of these methods is comparable. New methods fulfil the requirements of E911 phase II in the bad urban environment in relation to accuracy of MS geographical position calculation. The OTDOA+RTT-LMU method requires active connection with the cellular network to determine round trip time parameter. The accuracy of this method depends on initial estimation of parameters: co-ordinates of a mobile station at the discrete time  $n$  and  $n+1$ . The OTDOA+IPDL-LMU method is based on the moment of switch off of pilot channel transmission during IPDL mode detected by a mobile station. Therefore, this method needs extra information from higher layer to calculate the theoretical time differences between moments of switch off of base station transmission, when the relative time differences equal zero. The practical usefulness of this method depends on the "hearing" of distant base stations and detection accuracy moment of switch off of pilot channel transmission. Several authors have proved, for example in [14], that the same solutions allow for a good measurement precision of the time of radio signal arrival for distant base stations without using switch off of all channel transmission in a serving BS. Therefore the detection of switch off pilot channel transmission is possible. Moreover, using a modified IPDL method suggested in [15], which improves the system capacity, the proposed method OTDOA+IPDL-LMU can be available in 95% of the area network. In this case, the described method should be slightly modified. Instead of detecting the switch off of pilot channel transmission, we have to detect the moment of switch off of other channels.

Implementation of the OTDOA method for LCS in contemporary cellular networks is very expensive and brought by operators into effect rather reluctantly. Taking into account the obtained results, the proposed new methods for the geographical position of a mobile station exemplifies the low cost alternative to the classic one.

## 6. REFERENCES

1. A. Küpper: *Location-based Services, Fundamentals and Operation*, Wiley & Sons, 2005.
2. J. Stefański: *Simplified Algorithm for Location Service for the UMTS*, Proc. of IEEE 62nd Vehicular Technology Conference, vol. 4, 2005, pp. 2741-2744.
3. J. Stefański: *Method of Location of a Mobile Station in the WCDMA System without Knowledge of Relative Time Differences*, Proc. of IEEE 65th Vehicular Technology Conference, April 2007, pp. 674-678.
4. Y.T. Chan, K.C. Ho: *A Simple and Efficient Estimator for Hyperbolic Location*, IEEE Transactions on Signal Processing, vol. 42, no. 8, August 1994, pp. 1905-1915.
5. 3GPP Technical Specification: *Technical Specification Group Radio Access Network; Physical layer – Measurements (FDD)*, 3G TS 25.215.
6. W.H. Foy: *Position-location solutions by Taylor-series estimation*, IEEE Trans. Aerosp. Electron. Syst., vol. AES-12, March 1976, pp. 187-194.
7. 3GPP Technical Specification: *Technical Specification Group Radio Access Network; Physical layer procedures (FDD)*, 3G TS 25.214.
8. W.H. Sheen, J.K. Tzeng, C.K. Tzou: *Effects of Cell Correlations in a Matched-Filter PN Code Acquisition for Direct-Sequence Spread-Spectrum Systems*, IEEE Tran. on Vehicular Tech., vol. 48, no. 3, 1999, pp. 724-732.
9. J.P. Ianniello: *Large and Small Error Performance Limits for Multipath Time Delay Estimation*, IEEE Tran. on Acoust., Speech, and Sig. Proc., vol. ASSP-34, No. 2, 1986, pp. 245-251.

10. ETSI: *Universal Mobile Telecommunications System (UMTS); Selection procedures for the choice of radio transmission technologies of the UMTS*, TR 101 112, ver. 3.2.0, Apr. 1998.
11. Y. Jeong, H. You, C. Lee: *Calibration of NLOS error for positioning systems*, Proc. of IEEE 53rd Vehicular Technology Conference, vol. 4, 2001, pp. 2605-2608.
12. L.J. Greenstain, V. Erceg, Y.S. Yeh, M.V. Clark: *A new path-gain/delay-spread propagation model for digital cellular channels*, IEEE Trans. on Vehicular Tech., vol. 46, 1997, pp. 477-485.
13. D.N. Hatfield: *A Report on Technical and Operational Issues Impacting the Provision of Wireless Enhanced E911 Services*, Federal Communications Commission, September 2002.
14. E. Grosicki, K. Abed-Meraim, P. Loubaton, J.M. Chaufray: *Comparison of Downlink Mobile Positioning Methods for the UMTS FDD Mode without Using IPDL Periods*, Proc. of 7th International Symposium on Signal Processing and its Applications, vol. 2, 2003, pp. 347-350.
15. S. Moshavi, D. Yellli, J.S. Sadowsky, Y. Perets, K. Pick: *Pilot Interference Cancellation Technology for CDMA Cellular Networks*, IEEE Trans. on Vehicular Tech., vol. 54, no. 5, 2005, pp. 1781-1792.

to a

TH  
which,  
The me  
time in  
We can  
TH  
e.g. S m

\* Artykuł  
praktyczn