



## Research paper

# Numerical analysis on axial capacity of steel built-up battened columns

Paweł Pieczka<sup>1</sup>, Piotr Iwicki<sup>2</sup>

**Abstract:** This paper deals with the numerical analysis aimed at study the bearing capacity of pin-ended steel built-up columns under axial compression. Finite element (FE) models were performed for the columns presented in the literature. The main problem discussed in the article is the shape and magnitude of geometric imperfections introduced into the numerical FE model, necessary to obtain the load capacity consistent with the experimental strength tests. Three types of numerical analysis that can be used in Abaqus program to calculate the load bearing capacity have been described. The imperfections possible to introduce for built-up columns were presented and an equivalent imperfection corresponding to both imperfections recommended by Eurocode 3 (global of the entire column and local of the chord) for built-up members was proposed. The results of the geometrically and materially nonlinear static analysis were compared with the calculations according to the code procedures (Eurocode 3 and PN-B-03200:1990) and the results of experimental tests.

**Keywords:** steel, built-up member, buckling, numerical analysis, axial capacity

<sup>1</sup>MSc., Eng., Gdansk University of Technology, Faculty of Civil and Environmental Engineering, St. Gabriela Narutowicza 11/12, 80-233 Gdańsk, Poland, e-mail: [pawpiecz@pg.edu.pl](mailto:pawpiecz@pg.edu.pl), ORCID: 0000-0003-3939-9816

<sup>2</sup>DSc., PhD., Eng., Prof. GUT, Gdansk University of Technology, Faculty of Civil and Environmental Engineering, St. Gabriela Narutowicza 11/12, 80-233 Gdańsk, Poland, e-mail: [piwicki@pg.edu.pl](mailto:piwicki@pg.edu.pl), ORCID: 0000-0003-1652-2594

## 1. Introduction

For axially compressed columns, the cross-section moment of inertia influences the buckling resistance. One of the possibilities of manufacturing steel columns with relatively large moments of inertia in relation to steel expenditure is the use of built-up members. Such columns consist of parallel chords (hot-rolled or cold-formed) connected by lacings or battens. Connections can be welded or bolted.

The procedures for calculating the buckling capacity of built-up columns proposed in Eurocode 3 (EC3) [4] and PN-B-03200:1990 (PN) [17] have many limitations and do not describe in detail how to design with FEM. The procedure described in EC3 allows the calculation of internal forces in chords and battens by means of code formulas that take into account a global initial bow imperfection. Then the cross-section limit load is calculated for individual elements with assumption that the slenderness of the element is calculated for the chord in the part between the battens, see e.g. [10–12]). The PN procedure for built-up members allows the calculation of the buckling resistance using reduction factors calculated on the basis of the slenderness of both the entire column and the chord in the part between the battens (see e.g. [12]).

The article is a continuation of the considerations described in [16] where Eurocode 3 design procedure for compressed homogeneous members was adopted for the design of the built-up members. The procedure was based on the determination of the member cross-section slenderness on the basis of linear bifurcation analysis (LBA method) (for similar considerations see e.g., [3,6,19]). In the present paper, the buckling load coefficient was calculated for the shell model of the column, whereas previously it was obtained by the 1D beam model. Second original element of the paper consists in investigation of the imperfection magnitude needed to obtain the calculated load capacity similar to that known from experimental tests [15].

The issue of the buckling resistance of built-up members is still current. There are known articles in the literature dealing with the calculation of the bearing capacity of built-up columns (see e.g. [5, 7, 8, 14]). Furthermore, new types of battens are investigated in terms of both shape and connection methods (see e.g. [2, 18]). Other articles have focused on the determination of imperfections necessary to introduce in the numerical model of built-up members such as to obtain the load capacity results similar to those from strength tests and code calculations (see e.g. [9, 13, 18]).

## 2. Description of the investigated structure

The investigated structure was a built-up column composed of two parallel cold-formed chords of U profile and modular arrangement battens. Battens were made of flat bars and connected to the chords by pretension bolts (one on each side). Strength tests and material properties of the discussed columns were described in [15]. In this article, numerical calculations for 9 types of built-up columns were performed. The columns differ in terms of the length of the member  $L$ , the axial separation between battens  $a$ , and the distance



between the centroids of the chords  $h$ , see Fig. 1. Calculation of the bearing capacity according to the procedures for built-up members presented in EC3 and PN, and using the LBA method modelled by means of 1D elements for the columns in question were presented in the article [16]. In this article, the critical forces obtained from shell models were used to calculate the load capacity with the LBA method. In the article [16], it was shown that the critical forces obtained from both beam and shell models are similar.

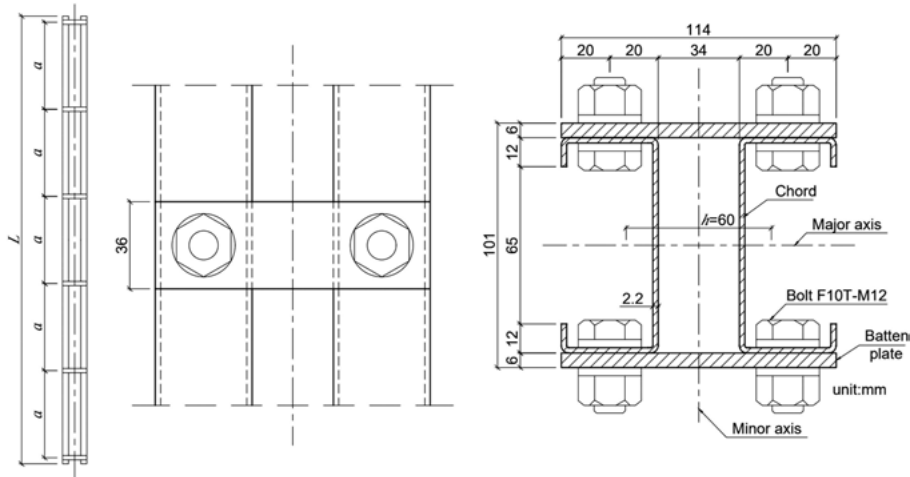

Fig. 1. Scheme and cross-section of the exemplary column based on [15]

Table 1 shows the material properties from the coupon tests of chords and battens used in [15], where:  $E$  is Young's modulus;  $f_y$  is the yield stress;  $f_u$  is the ultimate stress. The cross-sectional area of the column  $A$  consisting of two chords was  $396 \text{ mm}^2$ . The moment of inertia of the chord on the weak axis  $I_{ch}$  was  $86220 \text{ mm}^4$ . The results of the strength tests described in [15] are presented in Section 4.3.

Table 1. Material properties from coupon tests [15]

Parts	$E$ [MPa]	$f_y$ [MPa]	$f_u$ [MPa]
Chord	201600	306	456
Batten	213100	309	446

### 3. Code calculations

#### 3.1. Eurocode 3 procedure for built-up members

The EC3 [4] presents the code procedure for the design of built-up members. Calculating the load capacity of a column consists in checking the load capacity conditions of individual

elements (chords and battens). The method of calculating internal forces in the chords and battens is based on the moment  $M_{Ed}$  depending on the structure and load of the column, Eq. (3.1).

$$(3.1) \quad M_{Ed} = \frac{N_{Ed}e_0 + M_{Ed}^I}{1 - \frac{N_{Ed}}{N_{cr}} - \frac{N_{Ed}}{S_v}}$$

where  $N_{Ed}$  is the design value of the compression force applied to the built-up member,  $e_0 = L/500$ ,  $L$  is the length of the column,  $M_{Ed}^I$  is the design value of the maximum moment in the middle of the built-up member,  $N_{cr}$  is the critical force (elastic buckling) of the built-up member,  $S_v$  is the shear stiffness of the battened panel, and can be calculated by using Eq. (3.2).

$$(3.2) \quad S_v = \frac{24EI_{ch}}{a^2 \left(1 + \frac{2I_{ch}h}{nI_b a}\right)} \leq \frac{2\pi^2EI_{ch}}{a^2}$$

where  $E$  is Young's modulus,  $I_{ch}$  is in plane second moment of area of one chord,  $I_b$  in plane second moment of area of one batten,  $n$  is the number of battens,  $h$  is the distance between the centroids of the chords,  $a$  is the axial separation between the battens.

The chords are calculated in terms of compression with bending. For the compressive resistance, a reduction factor for buckling  $\chi$  must be taken into account. The design chord force  $N_{ch,Ed}$  should be determined from Eq. (3.3).

$$(3.3) \quad N_{ch,Ed} = 0.5N_{Ed} + \frac{M_{Ed}hA_{ch}}{2I_{eff}}$$

where  $A_{ch}$  is the cross-sectional area of one chord,  $I_{eff}$  is the effective second moment of area of the built-up member.

### 3.2. PN-B-03200:1990 procedure for built-up members

The code procedure presented in PN [17] consists in calculating the global buckling resistance of the entire column according to Eq. (3.4). This procedure is applicable only for columns whose failure mechanism is global buckling.

$$(3.4) \quad N_{Rd} = \varphi_m A f_y$$

where  $A$  is the cross-sectional area of the column,  $\varphi_m$  is the reduction factor for buckling and can be calculated by using Eq. (3.5).

$$(3.5) \quad \varphi_m = \left(1 + \bar{\lambda}_m^{2k}\right)$$

where  $k$  is a parameter dependent on the buckling curve, according to [17],  $\bar{\lambda}_m$  is the relative equivalent slenderness of the column and should be determined from Eq. (3.6).

$$(3.6) \quad \bar{\lambda}_m = \frac{1}{\lambda_p} \sqrt{\lambda_z^2 + \frac{m}{2} \lambda_v^2},$$



where  $\lambda_p = 84\sqrt{215/f_y}$  ( $f_y$  in MPa),  $m$  is the number of chords,  $\lambda_z$  is the slenderness of the column in relation to the minor axis (see Fig. 1),  $\lambda_v$  is the slenderness (obtained from  $I_{\min}$ ) of one chord in the section between the battens.

### 3.3. LBA method

This method was proposed in [16] and was based on the assumption that a built-up batted member can be treated as homogeneous. With this assumption, the global buckling resistance of the column  $N_{b,Rd}$  can be calculated according to point 6.3.1 of the EC3 [4] (Eq. (3.7)).

$$(3.7) \quad N_{b,Rd} = \frac{\chi A f_y}{\gamma_{M1}}$$

where  $\gamma_{M1} = 1.0$  is partial safety factor. A reduction factor for buckling  $\chi$  can be calculated by using Eq. (3.8). The imperfection factor for which the calculation results are the closest to the strength test results is  $\alpha = 0.49$  (buckling curve:  $c$ ). The non-dimensional slenderness  $\bar{\lambda}$  (Eq. (3.9)) can be calculated by using the elastic critical force of the entire column  $N_{cr}$  obtained from the linear buckling analysis performed on both the beam and shell models. For a Class 4 cross-section, the effective cross-sectional area  $A_{eff}$  must be calculated.

$$(3.8) \quad \chi = \frac{1}{\Phi + \sqrt{\Phi^2 - \bar{\lambda}^2}} \leq 1.0$$

$$\Phi = 0.5 \left[ 1 + \alpha (\bar{\lambda} - 0.2) + \bar{\lambda}^2 \right]$$

$$(3.9) \quad \bar{\lambda} = \sqrt{\frac{A f_y}{N_{cr}}}, \quad \text{for Class 1, 2 \wedge 3 cross-sections}$$

$$\bar{\lambda} = \sqrt{\frac{A_{eff} f_y}{N_{cr}}}, \quad \text{for Class 4 cross-sections}$$

## 4. Numerical analysis

Numerical models of the 9 types of columns described in [15] were made in the FEM commercial program Abaqus [1]. Four-noded shell elements (S4R) with reduced integration and six degrees-of-freedom per node were used to model the chords and the battens. Mesh size of 5 mm with a shape close to a square was selected for all models (see Fig. 2a). Due to the use of pretension bolts, it was assumed that the connection chord-batten were fixed. Fixed connections were introduced by tying the adjacent surfaces of the chord and the batten (each node of the chord was connected to only one node of the batten), see Fig. 2b. The material properties were assumed as elastic-plastic according to the data given



in the article [15]. The column was loaded with a concentrated force at one end. At both ends of the column pinned supports (on the minor axis) were modelled with a rigid body option, available in the ABAQUS library. The models consisted of about 80000 elements.

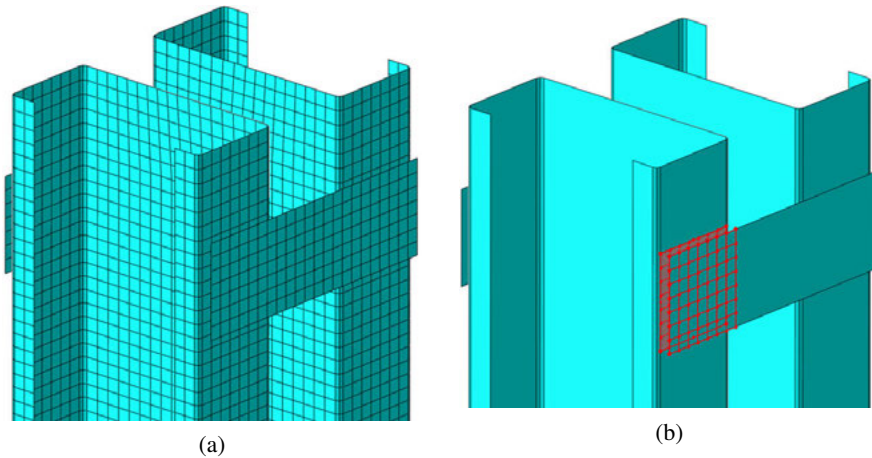

Fig. 2. Finite element model: a) meshing; b) nodes used in fixed connection chord-batten

#### 4.1. Type of analysis

Three types of analyses available in the Abaqus program [1] were used to calculate the column limit load: static general with load control, static general with displacement control, and static riks – arc length control.

In the first type of numerical analysis, a concentrated force was applied at one end of the built-up column. This force was greater than the limit load of the column. In the first calculation step, the initial part of the target force was applied (e.g. 1%), then in the following steps this force was increased until the solution convergence was lost. The calculation was interrupted when the limit load was reached.

Due to the displacement control used in the experiment, the second type of analysis corresponds best to the test set-up [15]. Load was applied to the column using a displacement of an upper support. The displacement increased incrementally while the reaction force results depend on the stiffness of the built-up member and can be read as a lower support reaction. After reaching the maximum reaction, the displacements continue to increase and the reaction in the column begins to decrease (stiffness decreases).

The last type of analysis solves simultaneously for loads and displacements. The progress of the solution is measured in the arc length along the static equilibrium path in load-displacement space. This type is useful for problems with the unstable post buckling path.

The load capacity for 9 built-up members using three types of analysis was calculated. Initial bow imperfection with  $L/500$  amplitude was introduced to each model. The results

for 2 ( $L3700\ a400\ h60$ ,  $L4500\ a880\ h60$ ) columns are shown in Fig. 3 and Fig. 4. All three methods provide the same load capacity results (maximum value in the load-displacement plot). Due to the lack of differences in the obtained results and the speed of calculation, the static general – load control analysis was used for further analyses.

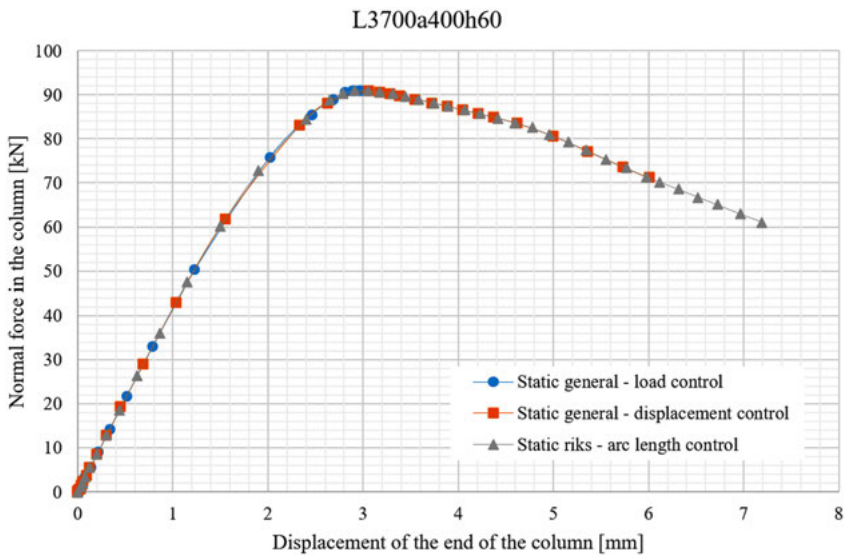

Fig. 3. The force-displacement graph for  $L3700\ a400\ h60$

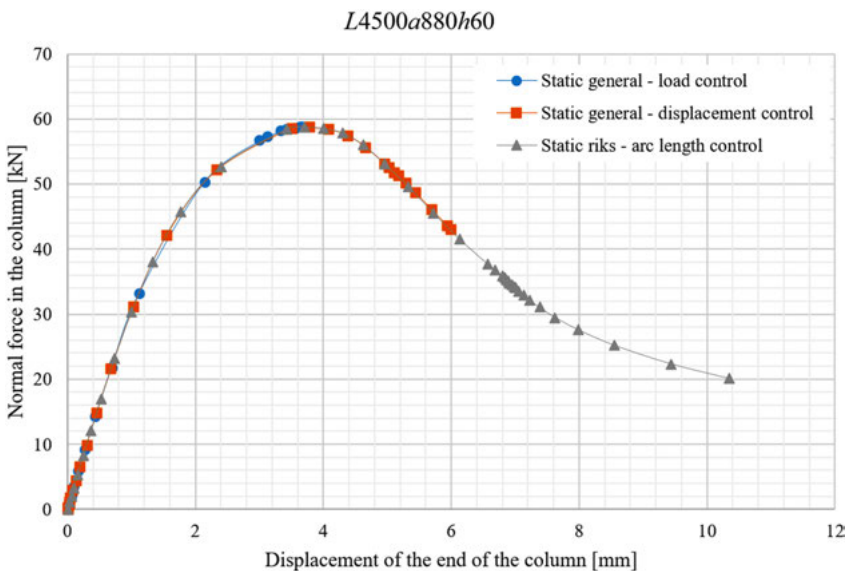

Fig. 4. The force-displacement graph for  $L4500\ a880\ h60$





## 4.2. Assumption of initial geometric imperfections

Numerical calculations were performed for the column with the initial geometric imperfection. Imperfections were assigned by importing nodal displacements from the linear buckling analysis with a set maximum displacement. Fig. 5 shows example imperfections used in analyses. To create a model corresponding to the EC3 code calculations, the initial global bow imperfection of  $L/500$  amplitude and the imperfection related to the possibility of buckling of a single chord should be introduced. Due to the use of a cold-formed C-section (class 4 cross-section) as a chord, it is recommended by EC3 to use bow chord imperfection  $a/200$  and to check the possibility of local and distortion buckling.

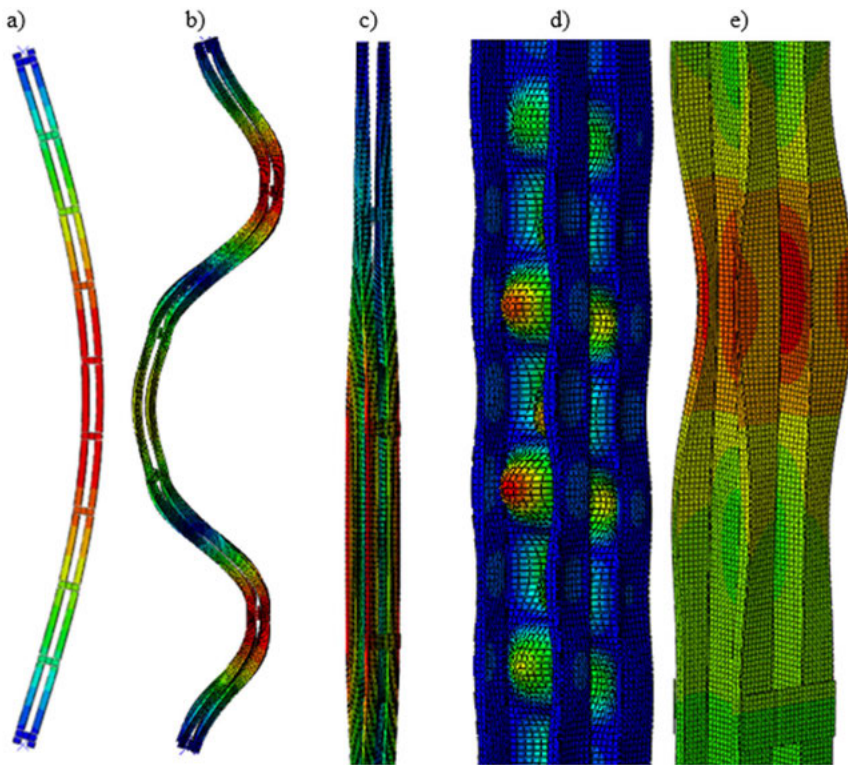

Fig. 5. Example imperfections used in analyses: a) global bow imperfection; b) global three-half wave imperfection; c) global torsional imperfection; d) local imperfection of the chord web; e) local bow imperfection of the chord with distortion of the cross-section

On the basis of preliminary analyses, it was found that:

- Introducing the global torsional imperfection of the entire column leads to an increase in the load capacity.
- Global three-half wave imperfection has a lower bearing capacity effect than global bow imperfection.



- Local imperfection of the chord web has an insignificant effect on the bearing capacity (e.g. 1% at 1 mm amplitude).
- Due to the difficulty of finding the proper buckling mode for the local chord buckling, it is possible to introduce an equivalent bow imperfection with an amplitude equal to the sum of the global and local amplitudes, see Fig. 6.

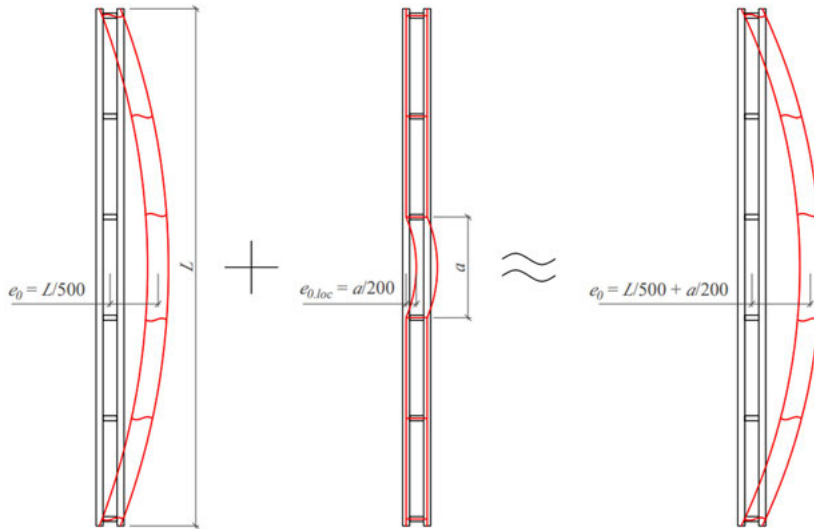

Fig. 6. An equivalent bow imperfection

### 4.3. Calculation of the load capacity

The load capacity was calculated for all columns assuming two imperfection cases, the first one recommended by EC3 for built-up members with  $(L/500)$  amplitude and the second one taking into account the additional possibility of buckling of the chord in the section between the battens with equivalent amplitude  $(L/500 + a/200)$ , see Fig. 6. The failure modes for the columns in question are shown in Fig. 7. In all cases, the mechanism of column failure was the exhaustion of the bearing capacity in the more compressed chord (left one in Fig. 7).

The summary of the strength tests results, the load capacities calculated using the code procedures (EC3 and PN), the LBA method (proposed in [16]), and numerical analyzes using both imperfection amplitudes are shown in Fig. 8. In all cases, both code procedures give load capacity results lower than the strength tests results. The load capacity obtained with the LBA method is on average closer to the load capacity from the strength tests, in some cases it is too high. On the basis of the obtained results, it is impossible to unequivocally state what imperfection amplitude should be entered into the model to obtain the load capacity close to the average of the measurements. Then, iteratively checked for which value of the global bow imperfection amplitude the load capacity from numerical analysis equal to the mean from the experiments, see Fig. 9.

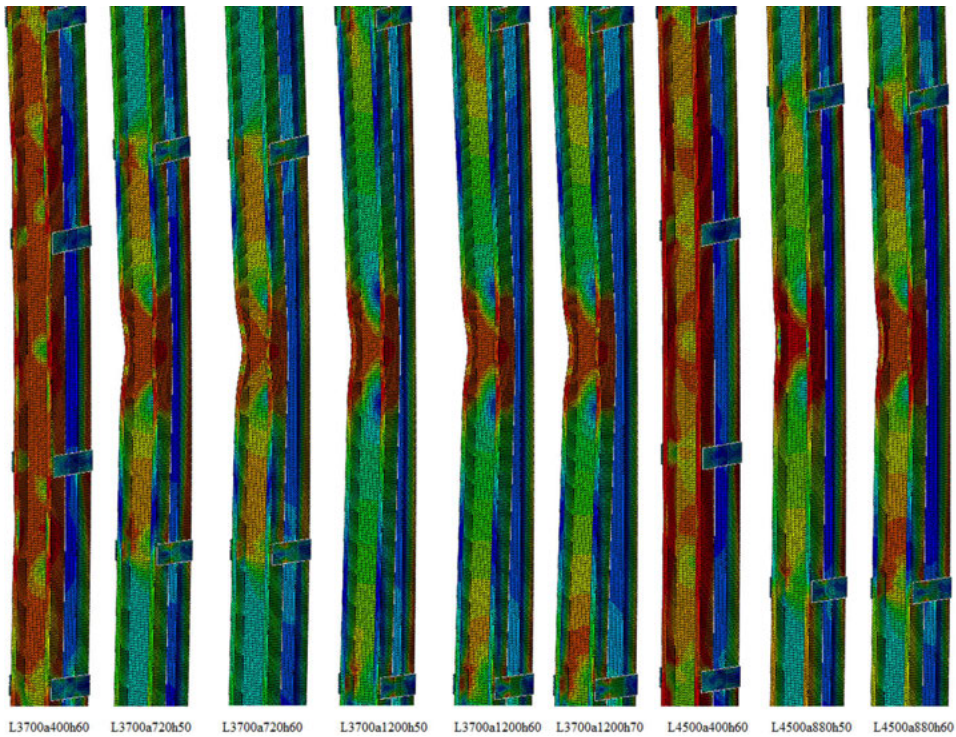

Fig. 7. Von Mises stresses distribution after exceeding the ultimate load capacity (displacement of the column end equal to 6 mm)

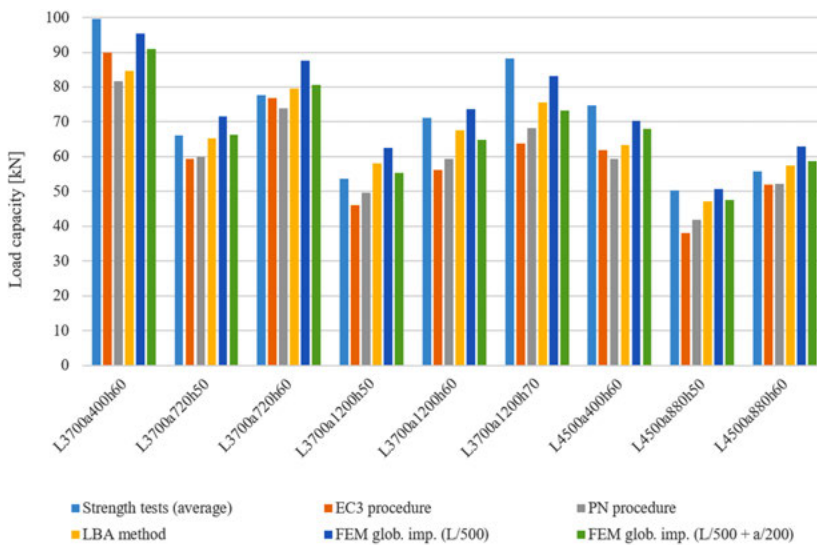

Fig. 8. Load capacities obtained by various methods

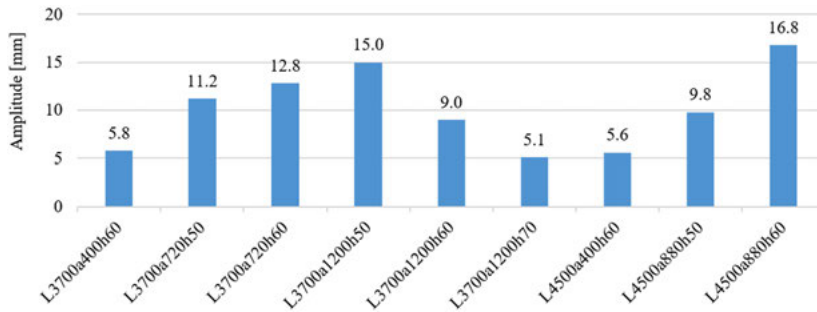

Fig. 9. Bow imperfection amplitudes which provided the calculated FEM bearing capacity equal to the average from the strength tests [mm]

The obtained amplitudes do not allow for the determination of a simple formula depending on the parameters of the built-up member, such as  $L/500$  or  $(L/500 + a/200)$ . Assuming that the formula for the amplitude value would depend only on the height of the column, Eq. (4.1) can be obtain.

$$(4.1) \quad \text{amplitude} = \frac{L}{\text{denominator}}$$

Table 2 shows the denominators of Eq. (4.1) for the columns in question.

Table 2. Denominator of the amplitude equation

Column	L3700 a400 h60	L3700 a720 h50	L3700 a720 h60	L3700 a1200 h50	L3700 a1200 h60	L3700 a1200 h70	L4500 a400 h60	L4500 a880 h50	L4500 a880 h60
Denominator of the amplitude equation	638	330	289	247	411	725	804	459	268

## 5. Conclusions and discussion

Based on the performed numerical analysis the following conclusions may be drawn:

- Introducing the imperfections recommended by EC3 into the shell model does not lead to obtaining results consistent with the strength tests. In some cases, the calculated load capacities were higher than the average from the strength tests, and it should be remembered that due to the dispersion of the results, some samples obtained lower load capacities;
- The LBA method can be used to calculate the global buckling resistance of a built-up column;



- Based on the presented analyses, it is impossible to define a simple formula for the imperfection amplitudes that should be entered into the model. This may be due to inaccuracies in the model, such as the lack of specific stiffness in the connection chord-batten;

Currently, the authors are conducting research on determining the stiffness of a connection made with a single pretension bolt. Another planned study is the performance of strength tests for types of built-up battened columns other than those presented in the article [15].

## Acknowledgements

The numerical calculations were performed using the computing resources of CITASK at Gdańsk University of Technology.

## References

- [1] *Abaqus, Theory Manual. Version 6.8.* Hibbit, Karlsson, and Sorensen Inc., 2008.
- [2] M. Anbarasu, M.A. Dar, “Axial capacity of CFS built-up columns comprising of lipped channels with spacers: Nonlinear response and design”, *Engineering Structures*, 2020, vol. 213, DOI: [10.1016/j.engstruct.2020.110559](https://doi.org/10.1016/j.engstruct.2020.110559).
- [3] M. Anbarasu, M.A. Dar, “Improved design procedure for battened cold-formed steel built-up columns composed of lipped angles”, *Journal of Constructional Steel Research*, 2020, vol. 164, DOI: [10.1016/j.jcsr.2019.105781](https://doi.org/10.1016/j.jcsr.2019.105781).
- [4] EN 1993-1-1 *Eurocode 3: Design of Steel Structures. Part 1.1: General rules and rules for buildings.* CEN (European Committee for Standardization), 2005.
- [5] M. Dabaon, E. Ellobody, K. Ramzy, “Experimental investigation of built-up cold-formed steel section battened columns”, *Thin-Walled Structures*, 2015, vol. 92, pp. 137–145, DOI: [10.1016/j.tws.2015.03.001](https://doi.org/10.1016/j.tws.2015.03.001).
- [6] M. Dabaon, E. Ellobody, K. Ramzy, “Nonlinear behaviour of built-up cold-formed steel section battened columns”, *Journal of Constructional Steel Research*, 2015, vol. 110, 2015, pp. 16–28, DOI: [10.1016/j.jcsr.2015.03.007](https://doi.org/10.1016/j.jcsr.2015.03.007).
- [7] M.A. Dar, D.R. Sahoo, A.K. Jain, S. Sharma, “Monotonic tests and numerical validation of cold-formed steel battened built-up columns”, *Thin-Walled Structures*, 2021, vol. 159, DOI: [10.1016/j.tws.2020.107275](https://doi.org/10.1016/j.tws.2020.107275).
- [8] M.A. Dar, N. Subramanian, M. Anbarasu, A.F. Ghowsi, P.A. Arif, A.R. Dar, “Testing and FE simulation of lightweight CFS composite built-up columns: Axial strength and deformation behaviour”, *Thin-Walled Structures*, 2021, vol. 167, DOI: [10.1016/j.tws.2021.108222](https://doi.org/10.1016/j.tws.2021.108222).
- [9] M.A. El Aghoury, A.H. Salem, M.T. Hanna, E.A. Amoush, “Ultimate capacity of battened columns composed of four equal slender angles”, *Thin-Walled Structures*, 2013, vol. 63, pp. 175–185, DOI: [10.1016/j.tws.2012.07.019](https://doi.org/10.1016/j.tws.2012.07.019).
- [10] M. Giżejowski, S. Wierzbiński, I. Kubiszyn, “Projektowanie elementów zginanych według PN-EN 1993-1-1 i PN-EN 1993-1-5”, *Inżynieria i Budownictwo*, 2008, vol. 64, no. 3, pp. 134–145.
- [11] J. Goczek, Ł. Supeł, M. Gajdzicki, *Przykłady obliczeń konstrukcji stalowych.* Łódź: Politechnika Łódzka, 2010.
- [12] E. Grochowska, A. Matysiak, “Konstrukcje stalowe ze słupami dwugałęzowymi z przewiązkami wg norm PN i EN”, *Przegląd Budowlany*, 2014, no. 9, pp. 41–45.
- [13] S. Kherbouche, A. Megnounif, “Numerical study and design of thin walled cold formed steel built-up open and closed section columns”, *Engineering Structures*, 2019, vol. 179, pp. 670–682, DOI: [10.1016/j.engstruct.2018.10.069](https://doi.org/10.1016/j.engstruct.2018.10.069).
- [14] P. Lorkowski, B. Gosowski, “Experimental and numerical research of the torsion problem of built-up steel columns laced in a single plane”, *Engineering Structures*, 2018, vol. 160, pp. 566–580, DOI: [10.1016/j.engstruct.2018.01.049](https://doi.org/10.1016/j.engstruct.2018.01.049).



- [15] K. Mitsui, A. Sato, "Flexural Elastic Buckling Stress of Batten Type Light Gauge Built-Up Member", *Civil and Environmental Engineering Reports*, 2017, vol. 25, no. 2, pp. 161–172, DOI: [10.1515/ceer-2017-0027](https://doi.org/10.1515/ceer-2017-0027).
- [16] P. Pieczka, P. Iwicki, "Axial capacity of steel built-up battened columns", in *Modern Trends in Research on Steel, Aluminium and Composite Structures, Proceedings of the XIV International Conference On Metal Structures (ICMS2021), Poznań, Poland*, 2021, pp. 442–448, DOI: [10.1201/9781003132134-57](https://doi.org/10.1201/9781003132134-57).
- [17] PN-B-03200:1990 *Konstrukcje stalowe. Obliczenia statyczne i projektowanie*. PKN (Polish Committee for Standardization), 1990.
- [18] R. Rahnvard, H.D. Craveiro, L. Laím, R.A. Simões, R. Napolitano, "Numerical investigation on the composite action of cold-formed steel built-up battened columns", *Thin-Walled Structures*, 2021, vol. 162, DOI: [10.1016/j.tws.2021.107553](https://doi.org/10.1016/j.tws.2021.107553).
- [19] J. Uziak, M. Gizejowski, "Coupled buckling design of steel laced columns", *Botswana Journal of Technology*, 2009, vol. 18, no. 2, pp. 42–48, DOI: [10.4314/bjt.v18i2.52261](https://doi.org/10.4314/bjt.v18i2.52261).

## Analizy numeryczne nośności osiowej stalowych słupów złożonych z przewiązkami

**Słowa kluczowe:** stal, słup złożony, wyboczenie, analiza numeryczna, nośność osiowa

Streszczenie:

Artykuł dotyczy analiz numerycznych mających na celu zbadanie nośności stalowych słupów złożonych z przewiązkami poddanych ścisaniu osiowemu. Dla słupów znanych z literatury wykonano modele numeryczne w programie Abaqus. Przedstawiono sposób modelowania połączenia między przewiązką a gałęzią słupa (zakładając, że ze względu na sprężenie śruby połączenie jest sztywne). Głównym problemem poruszonym w artykule są wprowadzone do modelu imperfekcje geometryczne, niezbędne do uzyskania nośności zgodnej z badaniami wytrzymałościowymi. Opisano trzy rodzaje analiz numerycznych możliwych do wykorzystania w programie Abaqus do obliczenia nośności słupa, a następnie przedstawiono najkorzystniejszą z nich (ze względu na szybkość wykonywania obliczeń). Zaprezentowane zostały imperfekcje możliwe do wprowadzenia do modeli słupów złożonych oraz zaproponowano zastępczą łukową imperfekcję odpowiadającą obu imperfekcjom zalecanym przez Eurokod 3 dla słupów złożonych (globalna całego słupa oraz lokalna gałęzi). Obliczone zostały nośności dla dziewięciu typów słupów zgodnie z procedurami normowymi dla słupów złożonych (Eurokod 3 and PN-B-03200:1990), metodą zaproponowaną w artykule [16] (obliczenie nośności na wyboczenie dla całego słupa zgodnie z procedurą EC3 dla elementów jednorodnych) oraz za pomocą geometrycznie i materiałowo nieliniowych analiz statycznych. Otrzymane wyniki porównano z wynikami z testów wytrzymałościowych znanych z literatury. Podjęto próbę określenia imperfekcji koniecznych do wprowadzenia do modeli numerycznych w celu uzyskania nośności zbliżonych do tych uzyskanych z badań wytrzymałościowych.

Received: 04.02.2022, Revised: 09.02.2022

