

---

# Potential changes in an electric field and electrolytic corrosion

---

*K. Zakowski and  
K. Darowicki*

---

## The authors

K. Zakowski and K. Darowicki are based at the Department of Anticorrosion Technology, Gdansk University of Technology, Gdansk, Poland.

---

## Keywords

Electrical fields, Corrosion, Metals

---

## Abstract

Sources have been described of corrosively hazardous electric fields and methods of determination of the corrosion hazard to metal structures caused by electrolytic corrosion. Results of potential and impedance investigations in the field of stray currents flowing out of a tram traction and in the presence of a defined electric field of low frequency have been presented. Uncertainties have been indicated relating to the generally accepted interpretation principles of measurement results in the presence of electric fields. The possibility has been indicated of incorporating the impedance spectroscopy technique to potential-voltage investigations, allowing estimation of the real corrosion interaction of stray currents on underground structures.

## Introduction

Electrolytic corrosion of metal underground structures caused by interaction of DC and AC electric fields is an important economic problem (e.g. repair costs), as well as an ecological one (e.g. leaks of aggressive media from pipelines and tanks to the ground) (Zakowski and Darowicki, 1999a). Hence, detection on the basis of field measurements of corrosively endangered places on structures becomes an important problem. Detection of such places allows prevention of breakdowns by applying local electrochemical anticorrosion protection (electric polarised drainage or impressed current cathodic protection).

Corrosive interaction of electric fields, frequently called current interference or stray current interaction, is investigated by methods based on potential measurements (Zakowski and Darowicki, 2000a). Structure potential changes recorded in the field vs the reference electrode are associated with electrolytic corrosion processes, occurring as a result of current flow through the metal-environment phase boundary.

Identification of potential changes with the intensity of electrode processes on the surface of the metal raises doubts. The aim of this work is the presentation of investigation results indicating that the adopted measures of electrolytic corrosion hazards are not always in compliance with the real corrosion interaction of electric fields.

## Current interference sources and determination of the corrosion hazard

Current interference on metal structures can be caused by DC currents (stray currents) and AC currents. The latter occur mainly in the neighbourhood of overhead power lines (Gummow *et al.*, 1999). A voltage is induced in metal structures laid parallel to the lines. In the case of pipelines covered with a high resistance insulation the potential difference between pipe ends can reach several tens of volts. Accelerated corrosion occurs in places of damage of the protective coating of the structure (Kajiyama and Nakamura, 1999).

---

This work has been supported by grant No. 3 T09B 012 18 from the Polish Committee for Scientific Research.

---

The main sources of corrosively hazardous electric fields are (Zakowski and Darowicki, 1999b):

- electric tractions powered by a DC current (tram, rail tractions, metro) (Moody, 1994),
- high voltage HVDC power transmission lines (Fitzgerald and Kroon, 1995),
- DC industrial equipment (e.g. welding machines) (Nikolakakos, 1998), and
- metal infrastructure cathodic protection systems.

In the vicinity of an electric field connected with the flow of stray currents places are formed on metal structures where intensive electrolytic corrosion processes occur. These are the so called anodic zones on the structure. For example, in regions of interaction of electric tractions these places are most frequently located near connections to rails of the return circuit (to the negative end of the traction substation). In other regions cathodic zones are formed on metal structures, in which corrosion processes are hindered.

HVDC lines can be either monopolar or bipolar (Fitzgerald and Kroon, 1995). The monopolar systems transmits energy in a single cable and uses the ground as a return conductor. Such lines transmit a direct current of the order of several kiloamperes. Bipolar systems transmit energy using two or more conductors, while only compensation currents flow in the ground. Currents from HVDC lines flowing in the ground can cause electrolytic corrosion on metal structures, especially long structures (pipelines, telecommunication cables, earthing systems). The places of corrosion attack are on the ends of structures located nearer the cathode, to which currents flow through the ground.

In the case of interference of cathodic protection, part of the current flowing out of the anode to the protected structure flows also to the neighbouring pipeline, and flows out of places of intersection or close proximity to the protected structure. In these places electrolytic corrosion of the unprotected pipeline occurs.

Standards and regulations propose adopting the value of the structure potential and the magnitude of its variations as an electrolytic corrosion hazard criterion (Polish Standard; TRbF, 1988). Conclusions concerning the hazard of corrosion caused by stray currents should be drawn on the basis of

calculated mean values of the potential shift in the positive and negative direction in relation to the stationary potential value (in the period of lack of stray currents). This method allows determination of only an approximate value of the electrolytic corrosion hazard – mainly due to burdening of measurement results with the IR component (ohmic voltage drop on the resistance between the structure and the reference electrode). The IR burden is the overriding factor and must be eliminated. Numerous methods are applied to achieve this (Zakowski and Sokolski, 1999b).

Investigation methods outlined in brief below are those most frequently applied in regions of interaction of dynamic stray currents flowing from DC sources.

- Measurement for a few minutes of the underground structure potential and the current flowing through a coupon connected to the structure (Martin and Brinsmead, 1995). By using the linear regression method the potential corresponding to the zero value of the current is determined. This potential is assumed to be the structure polarisation potential. This method would allow a close approximation of the IR free potential in the presence of DC interaction.
- Measurement at the same time of structure potentials and electric traction rail potentials (Park *et al.*, 1995). The activity of stray currents is determined by reporting mean values of these potentials and their standard deviations: greater fluctuations of potential means that activity of stray currents is greater.
- Extrapolation of the functional dependence after a several minute measurement of the structure potential and the gradient of the electric field in the ground in a direction perpendicular to the structure (Galimberti *et al.*, 1999). The potential value obtained by extrapolation is assumed to be the real potential devoid of the IR component.
- In Poland the correlation method is used for investigating stray currents (Zakowski and Sokolski, 1999a, b). The structure potential and voltage in relation to the current source are measured. Next, the mutual correlation spectrum potential-voltage is analysed. From the shape of the spectrum, its slope, concentration areas, discontinuities, perturbations, bends,

shifts – conclusions are drawn as to the character of interaction of stray currents in the measurement region.

In the above methods many doubts are raised by the assumed measure of the electrolytic corrosion hazard. The magnitude of the asymmetry coefficient does not always have to be in compliance with the intensity of electrode processes on the metal surface. Also, during anodic polarisation periods not only ionisation of metals occurs, but also a number of other electrode reactions.

## Experimental

The aim of the experiment was checking, if potential changes recorded in the presence of an electric field are connected with corrosion processes occurring on the metal surface, or if they result from field changes (i.e. they are changes of the potential IR component).

### Field measurements

Measurements were performed over a 10 year old underground  $\phi 400$  steel gas pipeline in a bituminous insulation, laid parallel to a tram traction powered by a DC source. The distance from pipe to railway was 30 m. Pipeline depth: 2 m. Soil resistivity:  $45 \pm 5 \Omega\text{m}$ . The following were recorded simultaneously: pipeline potential vs the buried copper sulphate reference electrode and the pipeline voltage in relation to tram rails. The buried electrode was placed 20 cm over the pipeline. Measurements were performed with a portable computer equipped with an AD converter card described earlier, with a 12 bit resolution and input resistance of  $10 \text{ M}\Omega$ . The sampling frequency of measured signals was 10 Hz and the duration of each recording was 30 min. The schematic diagram of the measurement system is shown in Figure 1.

Additionally, in order to investigate the general properties of the pipeline/reference electrode system, measurements were performed by the electrochemical impedance spectroscopy (EIS) technique. EIS investigations were performed in a two electrode system, in which the copper sulphate electrode was the investigated electrode, and a pipeline was used as the auxiliary electrode. These tests were performed with a Solartron 1260 analyser. The amplitude of the perturbation signal was

**Figure 1** Schematic diagram of the field measurement system

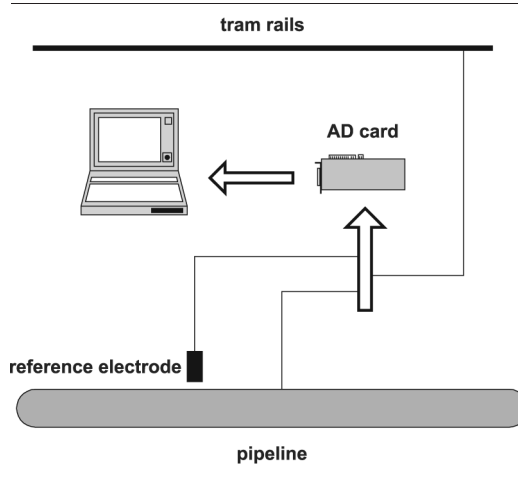

equal to 5 V. The measurement frequency range was from 10 kHz to 0.1 Hz.

### Laboratory measurements

Iron, silver and copper sulphate electrode potential changes vs the copper sulphate reference electrode were investigated in sand of different moisture content (resistivity). Potential measurements were performed in the presence of a low frequency (from 0.1 to 2 Hz) AC field with an amplitude of 10 to 50 mV. The choice of the frequency range was made on the basis of earlier investigations (Zakowski and Darowicki, 2000b) which had shown that only components of frequency lower than 1 Hz are present in signals measured in stray current fields flowing from a tram traction.

Electrode potentials were measured in the function of distance from the reference electrode (from 0 to 1 m). Measurements were performed by a computer equipped with an analogue-digital converter card of 12 bit resolution and  $10 \text{ M}\Omega$  internal resistance. The sampling frequency of the measured potential was 10 Hz. The duration of each single potential measurement was 5 min. An AC generator was the electric field source. The generator and measurement card ground were separated. The schematic diagram of the measurement system is shown in Figure 2.

In order to check the general properties of the investigated system impedance spectroscopy measurements were performed by a Solartron 1260 analyser. The amplitude of the perturbation signal was equal to 100 mV. The measurement frequency range was from 10 kHz to 10 MHz. The investigated

**Figure 2** Schematic diagram of a laboratory potential measurement system

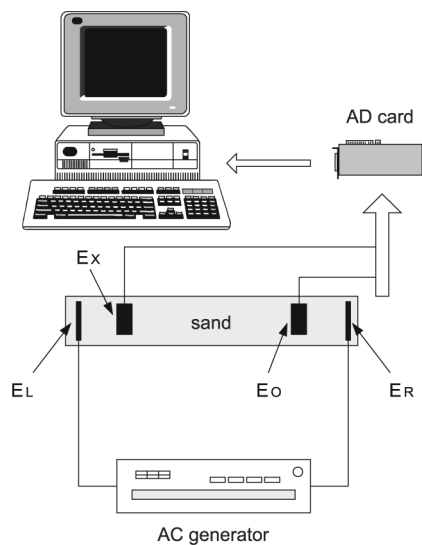

**Note:**  $E_L, E_R$  – platinised titanium electrode  
 $E_X$  – investigated electrode (Fe, Ag, Cu/CuSO<sub>4</sub>)  
 $E_O$  – reference electrode (Cu/CuSO<sub>4</sub>)

and reference electrodes acted as auxiliary electrodes.

## Results and discussion

### Field measurements

Figure 3 shows an example of results of simultaneous recording of pipeline-rail voltage  $U$  and pipeline potential  $E$  vs

the copper sulphate reference electrode in a stray current field from a tram traction. The dynamics of change of both signals were very high. In accordance with standards (Polish Standard; TRbF, 1988) and method (Park *et al.*, 1995) the intensity of stray current interaction and the electrolytic corrosion hazard to the pipeline were high. Similarly, correlation analysis  $E = f(U)$  of both measured signals in accordance with method (Zakowski and Sokolski, 1999a) gave a value of 63 per cent for the pipeline asymmetry potential in relation to the stationary potential. In accordance with the criterion adopted for this technique, this points to a high electrolytic corrosion hazard to the pipeline.

However, the above conclusions raise doubts. They result from the fact that potential and voltage changes in the function of time shown in Figure 3 are analogous. This creates a suspicion that the structure potential changes were exclusively changes of the IR component. This component is proportional to the voltage between the structure and the stray current source (tram traction rails in this case).

In Figure 4 the impedance spectrum has been presented of the pipeline/stationary electrode system on the Nyquist graph. For low frequencies, characteristic for stray currents associated with tram tractions (Zakowski and Darowicki, 2000b), the value

**Figure 3** Example changes:  $U$  - pipeline voltage vs tram rails and  $E$  - pipeline potential vs the copper sulphate stationary electrode

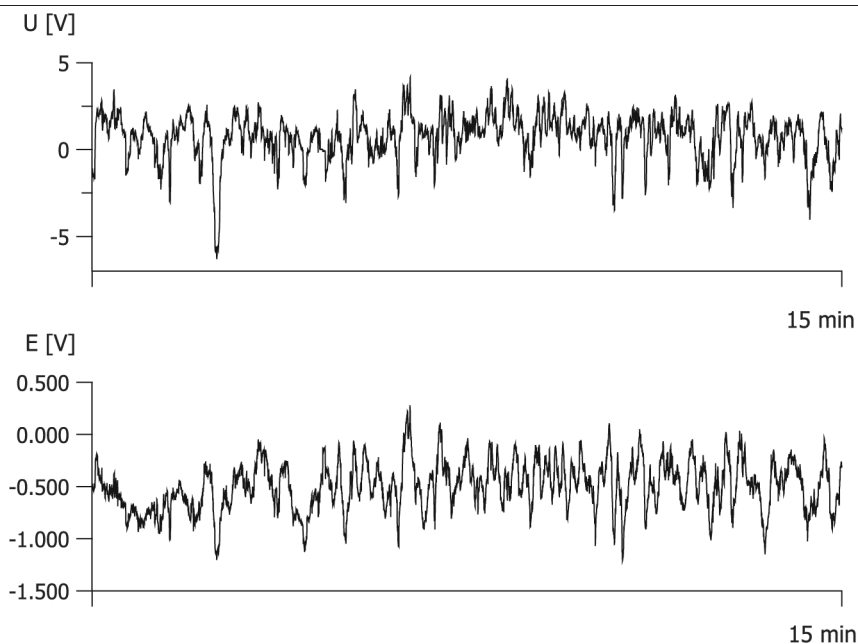
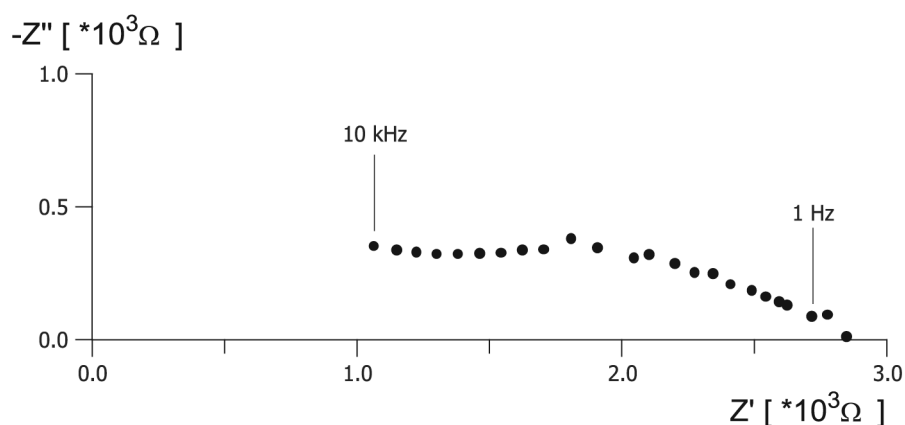

Figure 4 Impedance spectrum of the pipeline-stationary reference electrode system



of the imaginary component of impedance  $Z$  is close to zero. This indicates that the pipeline potential measurement result (Figure 3) was not affected by any capacitive effects in the pipeline-electrode system. The high resistance of this system for low frequencies (approx.  $3 \text{ k}\Omega$  - Figure 4) shows that the potential IR component was very high. From the obtained data it results that in the investigated system for a stray current of only approx.  $0.3 \text{ mA}$  the IR component would have been as high as  $1 \text{ V}$ . Indirectly obtained measurement results in Figures 3 and 4 thus show that in the investigated location stray currents are very small. The area of pipeline insulation defects through which these currents may flow is unknown. It is hard to accept that such a low current could become a corrosion hazard for the investigated over 10 year old pipeline with bituminous insulation (expected high total area of insulation defects). Hence, dynamic variations of pipeline potentials resulted solely from changes of the IR component, and electrolytic corrosion processes on the metal surface practically did not occur. This conclusion is contradictory to the results of analyses presented above after application of methods of electrolytic corrosion hazard determination described in the paper.

As can be seen from the above, incorporation of the impedance spectroscopy technique for analysis of stray current interaction on metal structures added many significant information. It allowed a more precise estimation of the real stray current interaction on the investigated structure in the place of performing measurements.

#### Laboratory investigations

Examples of investigation results of the electrolytic environment properties by

impedance spectroscopy have been presented in Figure 5. A pair of platinised titanium electrodes was connected to the generator, placed in sand of  $390 \Omega\text{m}$  resistivity at a distance of  $0.5 \text{ m}$  and  $1 \text{ m}$  from each other. The impedance spectra obtained point to dielectric properties of the sand layer. No effects connected with the capacitance of the investigated system at frequencies of approx.  $1 \text{ Hz}$  occur at which potential measurements which were carried out at these frequencies are also presented in this paper. The result of potential measurements presented later, therefore, depended only on the resistance of the system: investigated electrode – electrolytic environment – reference electrode.

In Figure 6 the results of potential measurements of an iron electrode vs the copper sulphate electrode in conditions with no electric field and in an electric field formed between  $E_L$  and  $E_R$  electrodes in sand of  $350 \Omega\text{m}$  resistivity are presented.

Potential oscillations are visible. The frequency of these oscillations corresponds to oscillations of the generated electric field. According to standards (Polish Standard; TRbF, 1988) and method (Park *et al.*, 1995) the recorded potential changes are connected with polarisation and are a measure of the susceptibility of an iron electrode to corrosion processes. According to the method (Zakowski and Sokolski, 1999a), the potential asymmetry potential equal here to 50 per cent (symmetric changes in relation to the stationary potential value) points to a very high electrolytic corrosion hazard to the steel electrode.

In Figure 7 a silver electrode potential recording has been presented in the same conditions as above. Identical potential

**Figure 5** Impedance spectrum of a sand layer between platinised titanium electrodes

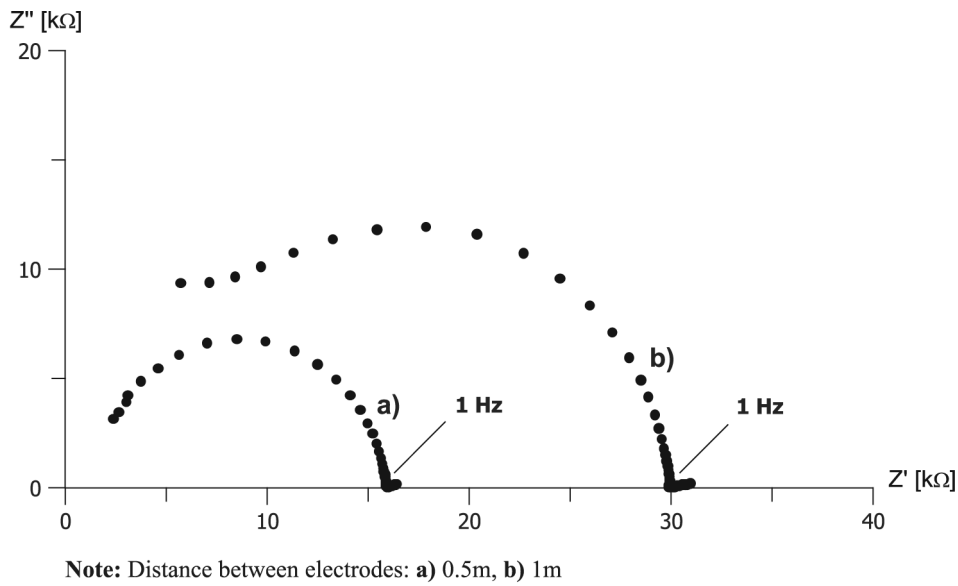

**Figure 6** Iron electrode potential changes vs the copper sulphate electrode in the following conditions: sand resistivity = 350  $\Omega m$ , distance between electrodes = 1 m, electric field:  $f = 1$  Hz, amplitude  $U_0 = 20$  mV

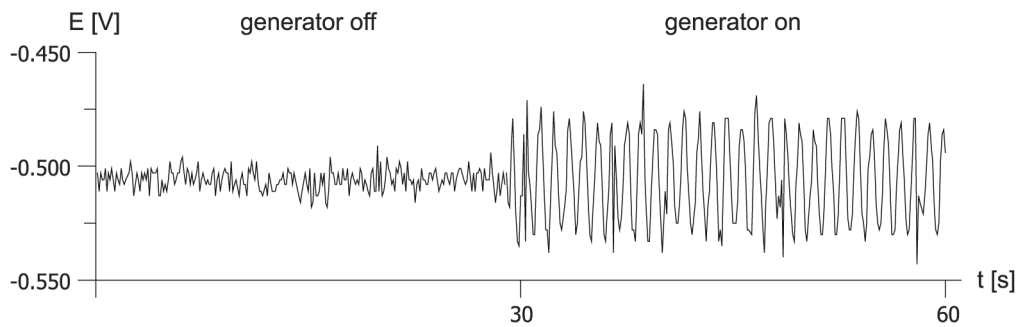

**Figure 7** Silver electrode potential changes vs the copper sulphate electrode in the following conditions: sand resistivity = 350  $\Omega m$ , distance between electrodes = 1 m, electric field:  $f = 1$  Hz, amplitude  $U_0 = 20$  mV

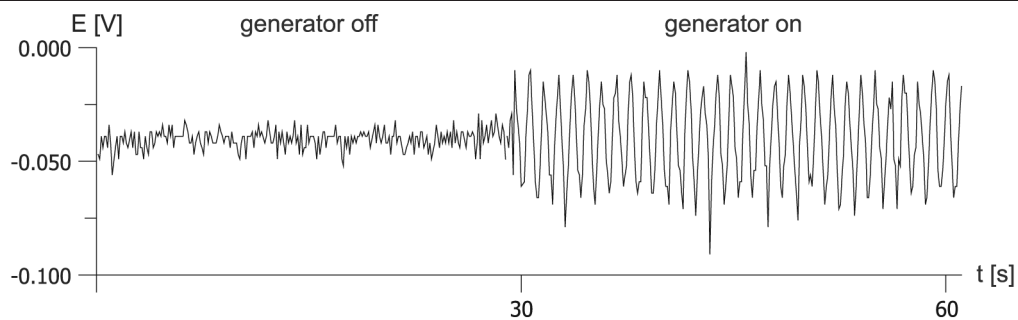

changes have been obtained, as in Figure 6. However, in the case of the silver electrode, as a noble material, it is difficult to discuss its susceptibility to corrosion.

The result of potential measurement of a copper sulphate electrode vs a copper sulphate electrode in the same conditions as above is a direct proof that the recorded

oscillations cannot be related to polarisation of the investigated electrode (Figure 8).

Next, the effect was investigated on the potential measurement result of the distance of the tested electrode to the reference electrode. In Figure 9 recorded potential changes have been shown in the presence of an electric field for several distances between

**Figure 8** Potential changes of a Cu/CuSO<sub>4</sub> electrode vs a Cu/CuSO<sub>4</sub> electrode in the following conditions: resistivity of sand= 350 Ωm, distance between electrodes = 1 m, electric field: f = 1 Hz, amplitude U<sub>0</sub>=20 mV

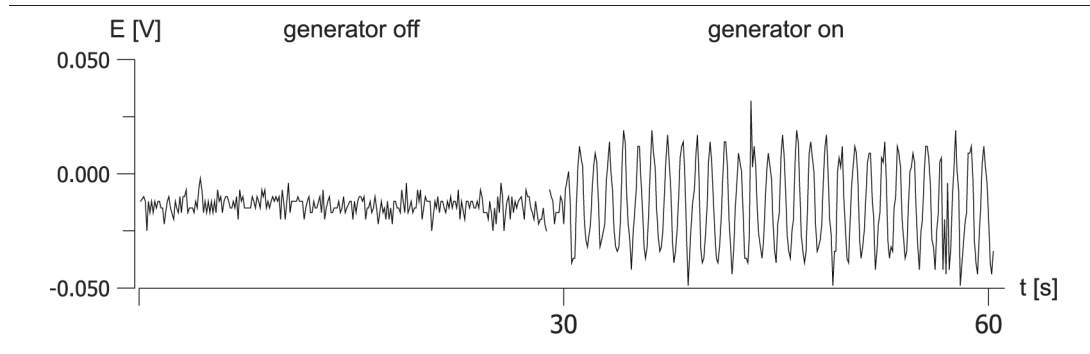

**Figure 9** Measured potential changes for different electrode distances

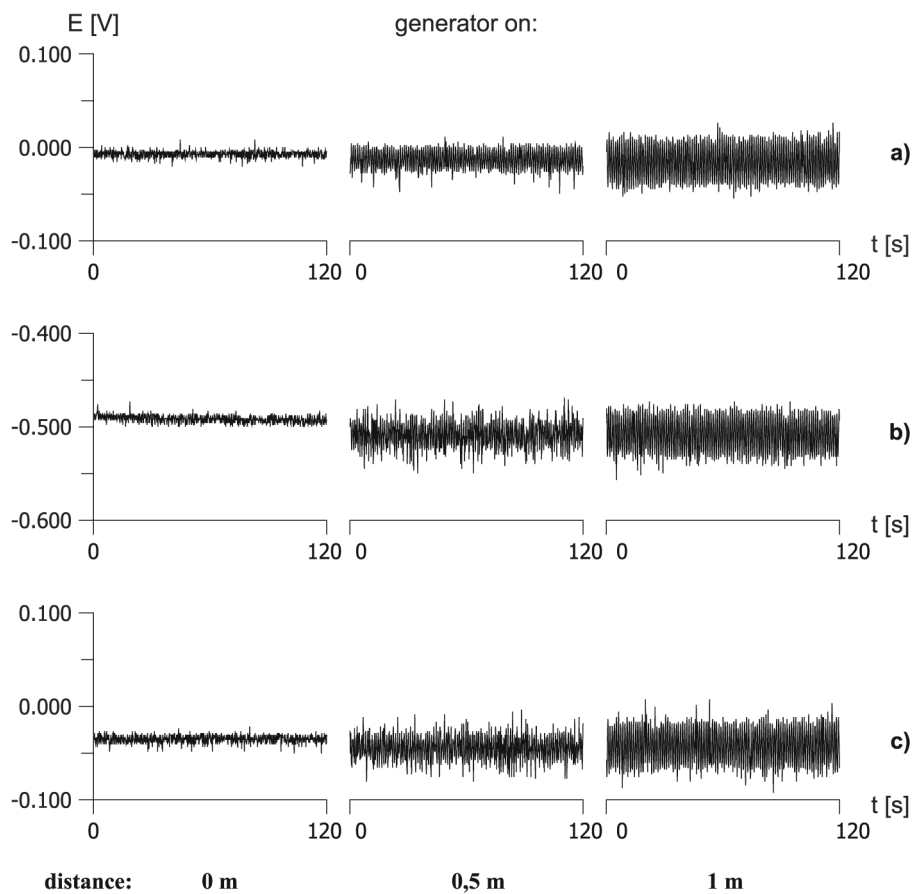

**Note:** a) copper sulphate electrode vs. the copper sulphate electrode,  
 b) iron electrode vs. the copper sulphate electrode,  
 c) silver electrode vs. the copper sulphate electrode

electrodes (environment and electric field identical as in Figures 6-8). The presented measurement results again show that analogous potential changes have been recorded independent of the investigated system. The dynamics of potential changes (standard deviation) grow with the increase of the distance between the investigated electrode and the reference electrode. They

are thus strictly connected with the resistance of the investigated system. Meanwhile, according to cited references (Polish Standard; TRbF, 1988; Park *et al.*, 1995) the greater the potential change dynamics the greater is the intensity of stray current interaction.

The magnitude of the measured potential depended on the ratio of the internal



**Figure 10** Electric schematic diagram of the measurement system (refers to Figure 1)

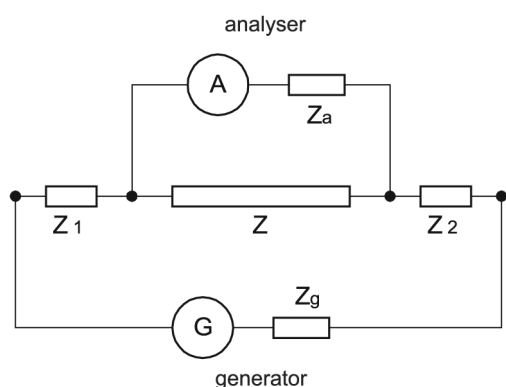

**Notes:** G – generator,  $Z_g$  – generator impedance,  
 A – analyser,  $Z_a$  – analyser impedance,  
 Z – impedance of investigated system,  
 $Z_1, Z_2$  – impedance between auxiliary  
 electrodes of the generator and  
 investigated electrodes

impedance of analyser and the impedance of the investigated system. This results from the analysis of the electric schematic diagram in Figure 10, corresponds to the applied measurement system (Figure 2).

If processes would have occurred in the investigated system connected with the presence of capacitance, then their presence should have been visualised by measurement results obtained for different electric field frequencies. Investigations performed (Zakowski and Darowicki, 2001) have shown lack of dependency of the measured electrode potential from the frequency of the electric field, in the presence of which measurements were carried out. This means that only the resistance of the investigated system had an effect on the result of potential measurements.

## Summary

The simple experiments and analyses presented earlier are an example of situations in which potential variations recorded in an electric field need not always be related to the intensity of electrode processes (polarisation) on the metal surface. Measurement results in a stray current field should therefore be interpreted with very high caution. In experiments presented in this work potential variations were strictly connected with the resistance of the investigated system (mainly the resistance of the environment between

investigated electrodes). The recorded potential changes were exclusively the changes of the generated electric field, in the presence of which the potential was measured. In other words, changes of the measured signal were exclusively the changes of the IR component. The current flowing in the investigated systems was not faradaic in character, i.e. it did not cause metal dissolution. Electrolytic corrosion processes did not occur. Hence, the corrosion hazard to metal structures in a stray current field need not always be directly correlated with the magnitude of potential variations, as proposed in methods (Polish Standard; TRbF, 1988; Park *et al.*, 1995), nor the asymmetry of potential changes, as proposed in method (Zakowski and Sokolski, 1999a).

In the paper it has been shown that application of the impedance spectroscopy technique for investigations of electric field interaction on underground structures can bring in new information, useful for determination of the real corrosion interaction of stray currents.

Further studies are necessary to verify the adopted and applied electrolytic corrosion hazard measures since (as shown in the paper) they are not always in compliance with the real stray current interaction.

## References

- Fitzgerald, J.H. III and Kroon, D.H. (1995), *Materials Performance*, Vol. 34 No. 6, p. 19.
- Galimberti, P., Gaddi, F., Alberizzi, M. and Lazzari, L. (1999), *Materials Performance*, Vol. 38 No. 3, p. 26.
- Gummow, R.A., Wakelin, R.G. and Segall, S.M. (1999), *Materials Performance*, Vol. 38 No. 2, p. 24.
- Kajiyama, F. and Nakamura, Y. (1999), *Corrosion*, Vol. 55 No. 2, p. 2000.
- Martin, B. and Brinsmead, H. (1995), *Ind. Corr.*, Vol. 3 No. 3, p. 10.
- Moody, K. (1994), *Materials Performance*, Vol. 33 No. 6, p. 15.
- Nikolakakos, S. (1998), *NACE Corrosion/98*, Paper No. 559.
- Park, K., Cho, Y., Jeon, K., Lee, S. and Kho, Y. (1995), *Journal of the Corrosion Science Society of Korea*, Vol. 24 No. 3, p. 176.
- Polish Standard PN-90/E-05030/01: "Corrosion protection. Electrochemical cathodic protection. Underground metallic structures. Requirements and tests".
- TRbF 522 (1988), Richtlinie für den lokalen kathodischen Korrosionsschutz (LKS) von unterirdischen Tankanlagen und Rohrleitungen aus metallischen Werkstoffen (LKS-Richtlinie).
- Zakowski, K. and Darowicki, K. (1999a), *Polish Journal of Environmental Studies*, Vol. 8 No. 4, p. 209.



---

Zakowski, K. and Darowicki, K. (1999b), *Proc. The European Corrosion Congress EUROCORR '99*, Aachen.

Zakowski, K. and Darowicki, K. (2000a), *Polish Journal of Environmental Studies*, Vol. 9 No. 4, p. 237.

Zakowski, K. and Darowicki, K. (2000b), *Proceedings International Society of Electrochemistry ISE 2000*, Warsaw, Paper No. 561.

---

Zakowski, K. and Darowicki, K. (2001), *Corrosion Reviews*, Vol. 19 No. 1, p. 55.

Zakowski, K. and Sokolski, W. (1999a), *Corrosion Science*, Vol. 41, p. 2099.

Zakowski, K. and Sokolski, W. (1999b), *Corrosion Science*, Vol. 41, p. 2213.