

PROFILE IRREGULARITIES OF TURNED SURFACES AS A RESULT OF MACHINE TOOL INTERACTIONS

Adam Boryczko

*Gdańsk University of Technology, Faculty of Mechanical Engineering, G. Narutowicza 11/12, 80-233 Gdańsk, Poland
([✉aboryczk@pg.gda.pl](mailto:aboryczk@pg.gda.pl), +48 58 347 1478)*

Abstract

The paper describes the influence of the machining operation on a surface, which disturbs the projection of the tool profile in the form of its relative movements with respect to the object. The elements of the machine tool undergo constant wear during the machining process, it is therefore important to recognize the effects of their influence on the surface's irregularities. Amplitude-frequency analysis of lateral profiles has been used to evaluate and changes of turned lateral profiles. The results of simulation of radial and axial effects of the machine tool on surface and their spectral components were analyzed. Surfaces obtained in similar machining conditions on lathes operated in various time periods were analyzed spectrally. From the analysis of surface irregularity changes caused by disturbances in movements of the tool against the object, testifying the wear of main machine elements during its operation, the modulated, amplitude-frequency character of changes in surface irregularities of workpiece can be noticed.

Keywords: surface irregularities, geometrical structure of surface, machine tool interaction, spectral analysis.

© 2011 Polish Academy of Sciences. All rights reserved

1. Introduction

The machine tool and the machining process determine to a large degree the accuracy and quality of obtained surfaces. As the machine tool elements undergo the wear and friction process during exploitation, it is essential to know the effects of their influence upon surface irregularities. Such analyses can be conducted comparatively in short and long working periods of the machine tool. For the purpose of surface analysis in short working time, a diagnostic search for the effect of the machine tool upon the surface can be carried out, and it can be used for a determination of working conditions, choice of a machine tool with defined technical accuracy or optimization of the technology for desired effects on the surface. Distinct differences in changes of surface of workpiece can be expected from comparative analyses carried out in a long time of operation of the machine tool. Tests of surfaces machined on machine tools of the same type, but with different intensity and exploitation time, as well as on a machine tool in various and longer working times gave a series of observations regarding changes of the geometrical surface structure (GSS) and their causes.

An evaluation of the influence of the technical condition of the used machine tool on the surface condition is required. This is a very complex issue because of indirect and multi-parametric interactions. Also because of ambiguous evaluation of surface irregularities, such evaluation becomes problematic and difficult to classify. There are many prerequisites from practice and simulation tests which confirm the influence of machine tool exploitation (wear) on the formation of GSS. This problem ought to be analyzed to find reasons of cause-and-

result of differences in irregularities on surfaces turned on machine tools with various exploitation periods.

The authors of [1-3] see the necessity of differentiating the components of waviness and roughness of surfaces. Contemporary decompositions of surface irregularities by wavelet methods in [4-6] do not provide practical technological and useful interpretations. Analyses of filtered irregularities are incomplete in diagnosing their origin [4, 7], also the use of standard roughness or waviness parameters does not lead to an analysis of the cause of irregularities [1, 8, 9]. Analyzing the irregularities with amplitude-frequency functions, the influence of the machine tool upon the object's surface can be grasped to a fuller degree [10-12]. The experience with spectral analysis of surface profiles and publications [6, 13, 14] lead to a wideband spectral formulation of surfaces.

2. Influence of the machine tool upon the workpiece

To analyze the influence of the machine tool on surface quality, machining with a single-point tool, characteristic for the often-found turning process, was chosen. Working movements of the machine tool with disturbances have essential influence on shaping surface irregularities of the workpiece. The main elements of the machining tool system (MTS) are: the workpiece (W), tool (T), linked by the cutting process (CP) and the machine tool (MT) constituting the dynamic machining structure (Fig. 1).

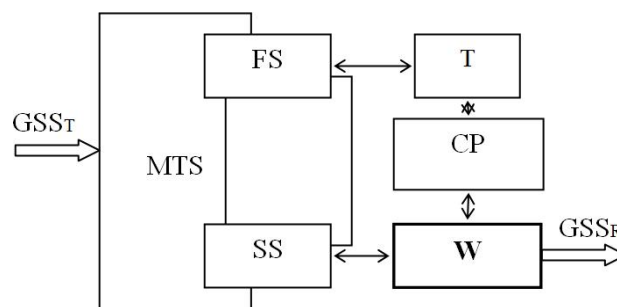

Fig. 1. Diagram showing formation of the real geometrical surface structure (GSS_R).

Interactions between them influence the formation of the real geometrical surface structure (GSS_R), as a matter of fact profile components in the form of error of form, waviness and roughness [2]. For a turned workpiece, the geometrical surface structure represented by transverse profiles is useful with regard to accuracy and quality. They contain the effects of the dynamic machining system in the machining process and they can be used for their identification and search for sources of essential errors on the surface. It is a formulation of “quasi”-dynamic effects of the machining system causing surface irregularities of stationary and ergodic character, treated as results of a short-lived process, registered on the surface in a “post-process” easy-to-analyze form [12]. Analyzing the surface with regard to the influence of the machine tool in utilization, one should take into account surfaces formed in similar machining conditions with greater spacing between their successive measurements. With the assumption that the technical state of individual elements of the machine tool system changes in time due to wear processes, we can make conclusions about their effect on GSS formed in the process. Influence of the tool on surface irregularities with tool tip without wear ought to be assumed. To analyze changes in shaping transverse GSS profiles, displacements of tool outline mapping in profile irregularities in the radial “x” direction and axial “y” direction for its successive revolutions were used (Fig. 2).

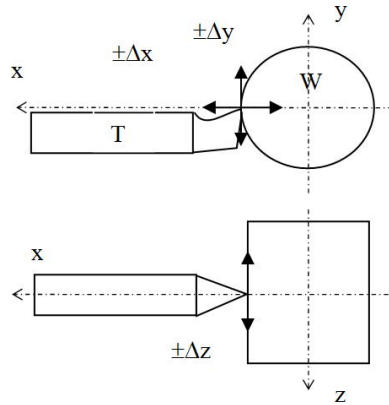

Fig. 2. Displacements of the tool with respect to the workpiece, as machine tool effect.

Displacements in the form of relative shifts of the tool to the workpiece (T-W) occur in a real turning process and they depend on the state of the machine tool. The more the machine tool is exploited, the greater the amplitude values of these changes and their frequency character is changing. It should be noted that relative T-W shifts can have a complex character and besides the direction perpendicular to the surface they have also a tangent (axial of the workpiece) direction, represented by distortions along the profile length.

3. Amplitude-frequency analysis of turned surface irregularity profile

Standard height parameters Ra , Rq used to describe the profile, do not characterize explicitly changes introduced to the profile by the process, particularly along the surface length. Profile parameter groups such as horizontal, point or bearing surfaces functions do not include a systematic and complex analysis of irregularity features of the measured surface profile [7]. Using height and other normative surface irregularity parameters, it is difficult to evaluate changes in their shaping which are highly visible on surfaces machined on longer-exploited machine tools. To satisfy these requirements, the amplitude-frequency analysis of irregularity changes in the form of their spectral functions described in [4, 7, 12] should be used. These functions describe which part of irregularity profile amplitudes belongs to individual frequencies of surface components in the broad range of their occurrence for roughness and waviness of the surface.

3.1. Theoretical irregularity profile from tool outline mapping

Theoretical irregularities of a transverse profile are appropriate for a surface turned on a new machine tool. Their irregularities include a repeating and regular mapping of the cutting edge with radius r_ϵ . Irregularities are characterized by constant heights Rt with periodic values equal to the tool feed per object rotation f , as shown in Fig. 3a and expressed by relationship [6]:

$$Rt = r_\epsilon - \frac{1}{2} \sqrt{4r_\epsilon^2 - f^2}, \quad (1)$$

where: Rt – theoretical height of surface profile irregularity, r_ϵ – radius of tool cutting edge rounded corner, f – tool feed per workpiece rotation.

The tool feed frequency ν_f is represented in spectral analysis by component [7]:

$$\nu_f = \frac{1}{f}. \quad (2)$$

The amplitude spectrum of theoretical irregularity from an undisturbed cutting edge contour is represented by components v_f , $2v_f$, $3v_f$, shown by the continuous line in Fig. 3b.

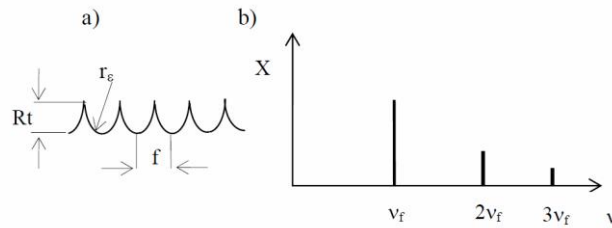

Fig. 3. Exemplary irregular profile of a theoretical surface (a) and its amplitude spectrum (b) X – amplitude spectrum of irregularities.

3.2. Real profile of surface irregularity of workpiece

In turning, surface irregularities are disturbed by effects from the machine tool and their character is very complex. Fig. 4 presents an exemplary profile of a turned surface and its amplitude spectrum with surface distortion components. Additional components shown by a broken line in Fig. 4b are distortions of surface profile coming from the lathe system.

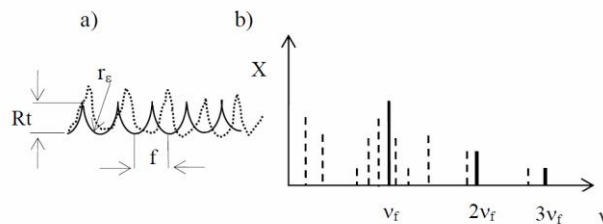

Fig. 4. Exemplary irregularity profiles of a surface (a), theoretical – solid line, distorted – broken line, and their amplitude spectra (b).

Changes of tool displacement with respect to the workpiece modulate two types of irregularities from tool profile. Directly in amplitude, increasing or reducing the heights of irregularities, and indirectly, to a lesser degree, shifting the vertices of the irregularities in the direction of profile length as their amplitude-frequency modulation. To simplify the simulation of the character of the influence of the machine tool on the surface, they were divided into two kinds, as relative displacements of the tool against the object in directions [7]:

- radial (amplitude modulation of theoretical irregularity),
- axial (amplitude-frequency modulation of theoretical irregularity).

Analyzing the theoretical GSS_T profile (solid line in Fig. 4a), simulated for an ideally realized machining process in comparison with real surfaces (broken line in Fig. 4a), the divergences between them can be shown as presented in amplitude spectra in Fig. 4b.

4. Analysis of machine tool effects on workpiece surface

4.1. Radial influence of the machine tool system on the surface of the workpiece

An example of modeling the roughness of a surface profile for mapping the tool contour with relative disturbances of the tool with respect to the object in the axial “x” direction is shown in Fig. 5.

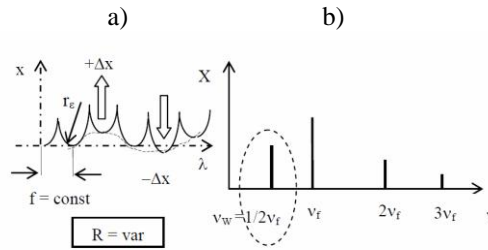

Fig. 5. Example of simulation of radial effects of the tool on the workpiece: (a) profile roughness, (b) amplitude spectrum of profile irregularity.

Radial T–W displacement for typical radial vibrations of the tool is the result of inaccuracy of the workpiece’s rotation system and dynamic changes of the cutting process, and on the surface modulates in amplitude the heights of profile roughness. Where: Δx – is the value of radial T–W displacement per object rotation, the sign “+” denotes carrying of the tool away from the object, “–” denotes drawing it nearer to it. Radial displacements of the mapped tool in the surface’s profile disturb indirectly the irregularities by modulating them at low frequency with small amplitude. This is invisible in the feed frequency v_f but manifests itself in the wideband presentation of irregularities as low-frequency surface waviness in the range $v_w \leq v_f$.

An example of disturbances of this kind, with explicit waviness of vertices of irregularities whose envelope forms an additional low-frequency $\frac{1}{2} v_f$ components, is presented in Fig. 5b. This component carries information on low-frequency disturbance of the surface in the radial direction of the object [3, 7]. Together with wear of elements in the object’s turning system, perpendicular displacement of the tool with respect to the object leads to such a character of changes whose values increase with an increase of the wear in exploitation [8]. In reality, such changes occur in a wider and lower band than the tool feed frequency v_f as an irregularity wave group and can be recognized in the spectrum. If it is highly difficult to conclude about the existence of this type of disturbances, from an analysis of normative parameters this is even more difficult, sometimes outright impossible.

4.2. Axial influence of the machine tool on the surface of the workpiece

Changes in displacement of the tool in the direction perpendicular to the surface “z” lead to irregular traces of its mapping in the profile and are caused by inaccuracies of the feed system and disturbances in realization of tool feed movements [8, 13]. They modulate in frequency the displacement of indentations along the length of the profile and indirectly, to a lesser degree, the heights of irregularities in the form of amplitude modulation, as presented in Fig. 6.

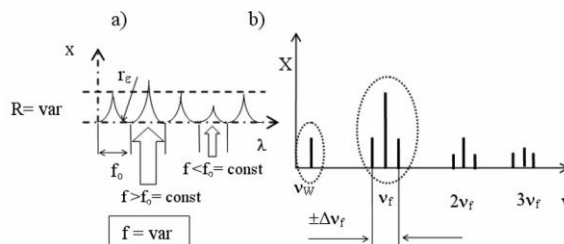

Fig. 6. An example of simulation of axial effects of the tool with respect to the workpiece: (a) profile irregularities, (b) amplitude spectrum of profile irregularities.

The placement of indentations in the irregularities is constant (Fig. 6a) and the heights of apices are modified in such a way that their envelope forms a long-term waviness evidenced in the irregularity spectrum by the low-frequency component ν_W (Fig. 6b). The tool tip frequency ν_f and its harmonics $2\nu_f, 3\nu_f, \dots$, are accompanied by a “sideband”, defined as deviation, representing inconsistencies in tool movement per object rotation. The values of these changes depend on the degree of irregularity of tool feed and they attest the wear and exploitation changes of the machine tool feed system [11, 14].

5. Irregularity types of turned surfaces with machine tool effects

Analyzing surfaces obtained in similar machining conditions on new machine tools and machine tools exploited in various periods, we should take into account different effects on the surface, recognized in the presented modeling. We ought to assume a long time between the compared GSS irregularities, machined on the same machine tool and in the same conditions. As changes introduced to the shaping of surface irregularities in different exploitation periods cannot be recognized explicitly through evaluation by normative parameters, the determination of irregularities should be carried out functionally with a common reference quantity in the whole range of irregularities, in the form of amplitude spectra of the surfaces. To prove this, spectra have been used of measured transverse profiles, executed in the same machining conditions on differently exploited machine tools.

For a surface turned on a new lathe, there appears a line mapping the contour of the tool tip with a feed frequency $\nu_f = 1/f$ together with subsequent harmonics $m\nu_f$ for $m = 2, 3, \dots$, approximately as presented in Fig. 3b for a theoretical turned surface. In the case of new machine tools, the level of disturbances of formed surface irregularities distorts them to a small degree, which gives also insignificant changes in the character of the irregularity spectrum. The spectra presented in Fig. 7 and Fig. 8 for profiles turned on lathes exploited for longer periods of time differ significantly by the form and participation of irregularity frequency components.

5.1. Effects of surface irregularities from radial T – W displacements

Fig. 7 presents amplitude spectra of a surface turned on a lathe which has been exploited for 16 years, in order to compare them with a theoretical irregularity for ideal mapping of the tool. The character of the diagram has changed radically in the low-frequency part of the spectrum marked by the broken line frame. This is connected with the appearance of a clear irregularity wave group and several dominating lines at frequencies with numbers $k = 1; 4; 12; 15; 27; 48$ as main waviness components in the surface profile. The amplitudes of three low-frequency waviness components exceed the value of the tool feed frequency ν_f for $k = 96$. The frequency for irregularity component k can be determined from equation [7]:

$$\nu = \frac{k}{N \cdot h_p}, \quad (3)$$

where: k – is the successive number of the frequency component; $k = 1, 2, \dots, N/2$, N – the number of samples in the profile length, h_p – the sampling section of profile irregularity.



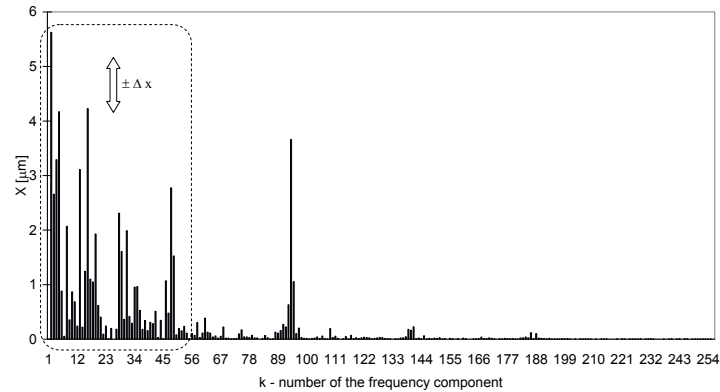

Fig. 7. Amplitude spectrum of an exemplary surface turned on a lathe with exploited workpiece turning system.

This is an amplitude spectrum of a very disturbed surface with the appearance of low-frequency components. This irregularity is an example of amplitude modulation of the tool contour by machine tool disturbances in the radial direction of the object “*x*”. They are caused by inaccuracy of operation the exploited spindle turning system and its bearing.

5.2. Effects of surface irregularities from axial *T–W* displacements

For a surface obtained on a machine tool exploited for four years, shown in Fig.8, in its spectrum we see an explicit “spectrum line broadening” of the tool feed v_f with the frequency number $k = 84$ in the range of 18 components and subsequent harmonics, e.g. $2v_f$ with $k = 168$. This constitutes $\pm 10\%$ of tool feed irregularity from the feed system and the uneven realization of this quantity testifies the degree of its wear. There is also a narrow band of several low-frequency components of profile waviness with small amplitudes. This is disadvantageous, because of significant surface errors in relation to the feed component in the roughness range. This confirms the frequency modulation of tool contour mapping with intermediate amplitude changes as envelopes of height changes of irregularity apices. This is an example of frequency modulation of the tool contour mapping by machine tool disturbances in the axial direction of the object “*z*”, resulting from uneven movement of the exploited tool feed system.

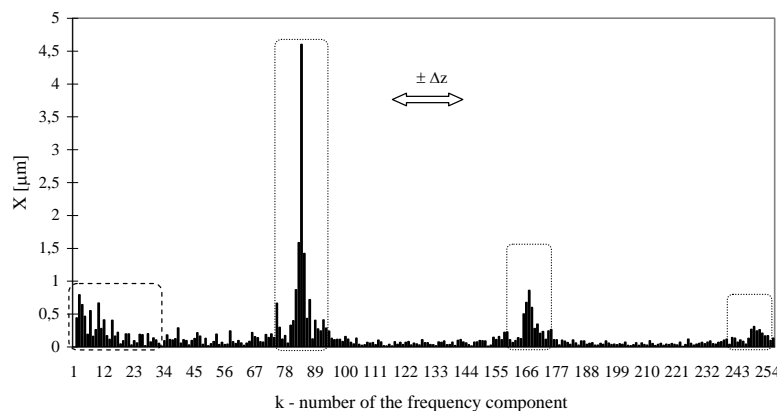

Fig. 8. Amplitude spectrum of an exemplary surface turned on a machine tool with exploited tool feed system.

6. Conclusions

The presented types of modulation illustrate the complex character of irregularities, at the same time the modulations in amplitude are to a higher degree significant for surface inaccuracies. They appear in the low-frequency range and show the character of long-term surface waviness, or even shape error along the profile length. Disturbances with frequency modulation are disadvantageous for surface accuracy and the amplitude-frequency modulation of irregularity apices distorts the surface with additional low-frequency waviness components with smaller amplitudes.

From the analyses of irregularity changes caused by disturbances in the displacement of the tool with respect to the workpiece, which testify to the wear of main parts of the machine tool during its exploitation, we can observe the modulating, amplitude-frequency character of surface irregularity of the surface of workpiece turned on it (Table 1).

Table 1. Types of tool displacement, surface irregularity and turned surface profile components.
Where: MT(SS) – machine tool (spindle system), MT(FS) – machine tool (feed system), CP – cutting process, T – tool, W – workpiece.

Type of tool displacement	Direction of tool displacement	Disturbances from displacement / parameters	Parameters and surface components	Disturbances type from tool	Source of disturbances
Radial $\pm\Delta x$	Perpendicular to the axis of workpiece	Amplitude / Heights	Form, waviness, (roughness)	Amplitude modulation (frequency modulation)	MT(SS) T CP W
Axial $\pm\Delta z$	Parallel to the axis of workpiece	Frequency / Lengths	Form, waviness, roughness, micro-irregularities	Frequency modulation (amplitude modulation)	MT(FS) T CP W
Tangent $\pm\Delta y$	Tangential to the workpiece	–	micro-irregularities	–	CP T W

A frequency analysis of the surface can be used to recognize the type of influence of the machine tool, by the shape and placement of spectrum components in relation to the basic ν_f tool feed frequency.

In reality, the presented types of surface disturbances appear in a broad band of profile frequency components, as irregularity wave groups. They can be recognized in the spectrum in the ranges of roughness, waviness and even shape error components of the surface profile.

References

- [1] Raja, J., Muralikrishnan, B., Shengyu, Fu. (2002). Recent advances in separation of roughness, waviness and form. *Precision Engineering*, 26, 222-235.
- [2] Boryczko, A. (2010). Distribution of roughness and waviness components of turned surface profiles. *Metrology and Measurement Systems*, 17(4), 611-620.
- [3] Jang, D.J., Choi, Y-G., Kim, H-G., Hsiao, A. (1996). Study of the correlation between surface roughness and cutting vibrations to develop an one-line roughness measuring technique in hard turning. *Int. J. Mach. Tools and Manufact.*, 36(4), 453-464.

- [4] Haosheng, LI., Su, WU., Kratz, H. (2007). FFT and Wavelet-Based Analysis of the Influence of Machine Vibrations on Hard Turned Surface Topographies. *Tsinghua Science and Technology*, 12(4), 441-446.
- [5] Lingadurai, K., Shunmugam, M.S. (2006). Metrological characteristic of wavelet filter used for engineering surfaces. *Measurement*, 39, 575-584.
- [6] Whitehouse, D.J. (2002). *Surfaces and their Measurement*. Hermes Penton Ltd. London.
- [7] Boryczko, A. (2003). Adjust parameters of digital measurement of inequality profile of the nature of the surface of the object. *Measurement Automation and Monitoring*, 56(9), 1063-1066. (in Polish).
- [8] Bigerelle, M., Gautier, A., Hagege, B., Favergeon, J., Bounichane, B. (2009). Roughness characteristic length scales of belt finished surface. *Journal of Materials Processing Technology*, 209, 6103-6116.
- [9] Boryczko, A. (2003). The method of frequency analysis turned surface irregularities in the diagnosis of machining. Monographs 42. *Publisher Gdańsk University of Technology*, Gdańsk. (in Polish)
- [10] Sata, T., Li, M., Takata, S., Hiraoka, H., Li, C.Q., Xing, X.Z., Xiao, X.G. (1985). Analysis of Surface Roughness Generation in Turning Operation and its Applications. *Annals of the CIRP*, 34/1, 473-476.
- [11] Boryczko, A. (2010). Cylindrical surface irregularities presented by frequency spectra of relative tool displacement to the workpiece. *Measurement*, 43(4). 586-595.
- [12] Bendat, J.S., Piersol, A.G. (1971). *Random Data; Analysis and measurement procedures*, Wiley InterScience, New York.
- [13] Boryczko, A. (2010). Profile irregularities of turned surfaces resulting from machine tool interactions. 3rd International Conference MANUFACTURING 2010. Contemporary problems of manufacturing and production management. *PROCEEDINGS abstracts, Poznań University of Technology*. (in Polish)
- [14] Moon, K.S., Sutherland, J.W. (1994). The Origin and Interpretation of Spatial Frequencies in a Turned Surface Profile, *Journal of Engineering for Industry*, 116, 340-347.