

RESEARCH INTO FLOWS IN TURBINE BLADE SEALS PART III: NUMERICAL CALCULATIONS VERSUS EXPERIMENT

KRZYSZTOF KOSOWSKI¹, ROBERT STEPIEŃ¹,
MARIAN PIWOWARSKI¹ AND JANUSZ BADUR²

¹*Faculty of Ocean Engineering and Ship Technology,
Gdansk University of Technology,
Narutowicza 11/12, 80-952 Gdansk, Poland
{kosowski,rstepien}@pg.gda.pl*

²*Institute of Fluid-Flow Machinery, Polish Academy of Sciences,
Fiszera 14, 80-952 Gdansk, Poland
jb@imp.gda.pl*

(Received 31 January 2003; revised manuscript received 10 April 2003)

Abstract: Experimental and theoretical investigations of the pressure field in the shroud clearance were performed on a one-stage air model turbine of the impulse type. Measurements of pressure distribution were carried out for various rotor speeds and turbine loads. 3D calculations of flows in this turbine were performed using the FLUENT CFD code. The calculations were carried out for variants which had been measured experimentally. The experimental data have been compared to theoretical results obtained with 3D codes for turbomachinery calculations. The Sliding Mesh and Multiple Reference methods have given very similar results of average values of pressure distribution and the velocity field in the shroud clearance. These results correspond to the experimental data. The pressure pulsations were determined only by the Sliding Mesh method, and these results have also been compared with the experiment. Stage flow calculations carried by the Sliding Mesh method with a structural shroud mesh and with a minimum number of 2–2.5 million cells have given a range of non-stationary pressure pulsations corresponding to the experimental data.

Keywords: turbine seals, CFD calculations, experimental investigations

1. Introduction

The investigations were carried out to show how a CFD code can cope with determining the pressure field in a rotor blade shroud clearance. In part I of the paper, the experimental stand and the calculating methods have been described, while detailed numerical analysis is presented in part II. The experimental investigations of the pressure field in the shroud clearance were performed on a one-stage air model

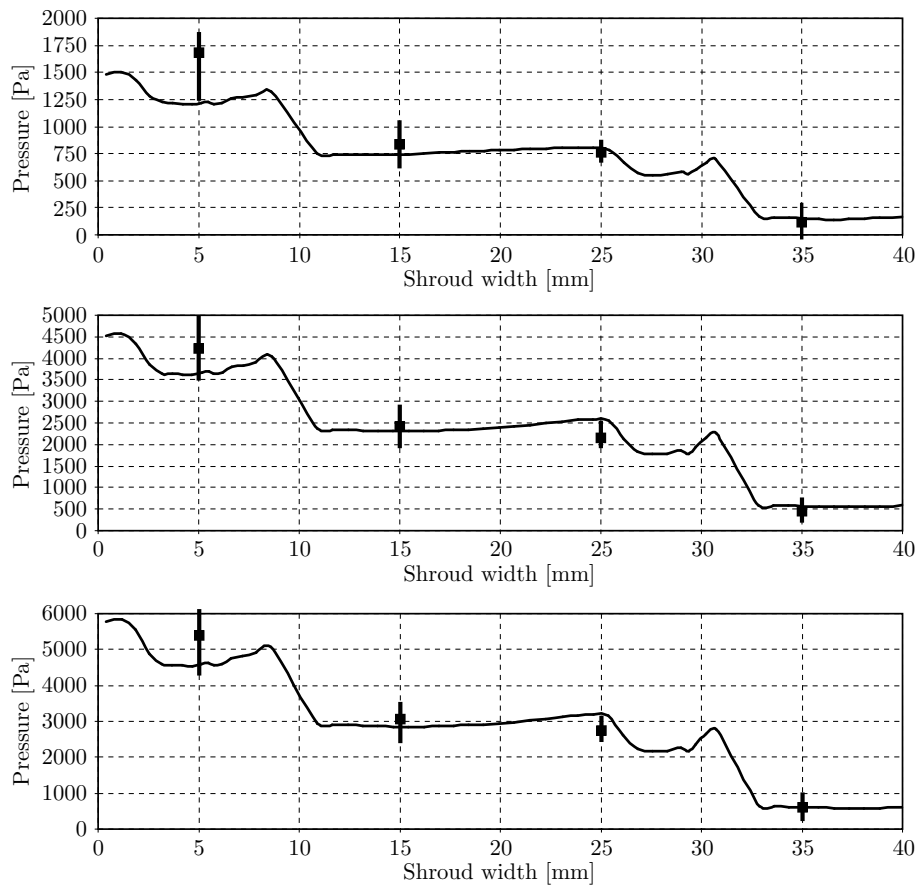

Figure 1. Pressure distribution along the shroud width: solid line – average pressure calculated by the SM method, bars – range of pressure changes according to the experimental data (from top to bottom: $\omega = 311 \text{ rad/s}$, $\omega = 566 \text{ rad/s}$ and $\omega = 645 \text{ rad/s}$)

turbine of the impulse type (described in part I). Measurements of pressure distribution were carried out for various rotor speeds and turbine loads. 3D calculations of flows in the model turbine were performed using the FLUENT CFD code. The Multiple Reference Frame method, the Mixing Plane method and the Sliding Mesh method were applied, and meshes of various types and configurations were used in the investigations. Calculations of flows in the model turbine were carried out for the variants of rotor speed and the corresponding inlet and outlet air parameters which had been measured experimentally. A comparison of experimental and calculated results, followed by a discussion, is presented in this part of the paper.

2. Pressure distribution

2.1. Averaged pressure

According to the results of our calculations, the Sliding Mesh and Multiple Reference methods give very similar results of average values of pressure distribution and the velocity field in the shroud clearance (see part II). The results obtained by these methods correspond to the values of pressure at the measuring points recorded

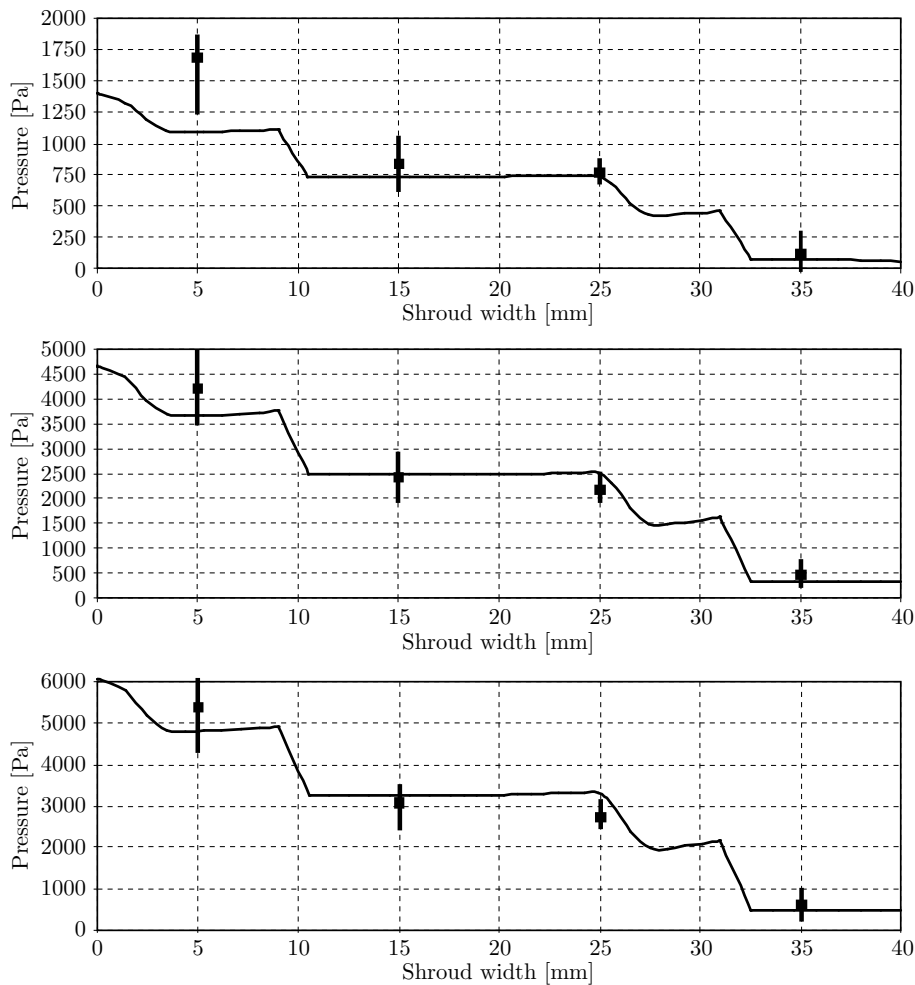

Figure 2. Pressure distribution along the shroud width: solid line – average pressure calculated by the MRF method, bars – range of pressure changes according to the experimental data (from top to bottom: $\omega = 311\text{rad/s}$, $\omega = 566\text{rad/s}$ and $\omega = 645\text{rad/s}$)

during the experiment. This conclusion is confirmed by data presented in Figures 1 and 2 for the Sliding Mesh and Multiple Reference methods, respectively. The solid lines in these figures show the calculated mean pressure distributions in the blade shroud clearance for various rotor speeds, while the measured range of pressure pulsations is marked with bars. The calculated results obtained by applying the SM and the MRF methods correspond to the experimental data, especially for high rotor speeds (closer to the nominal value of the turbine rotor speed).

2.2. Pressure pulsations

Only the Sliding Mesh technique has appeared to describe non-stationary effects and the pressure pulsations in the turbine flow channels and clearances. In Figures 3 and 4, the pressure pulsations determined by the Sliding Mesh method are compared to the experimental results. In Figure 3, the range of calculated pressure pulsations is compared with the range of the pressure changes recorded during the experiment for

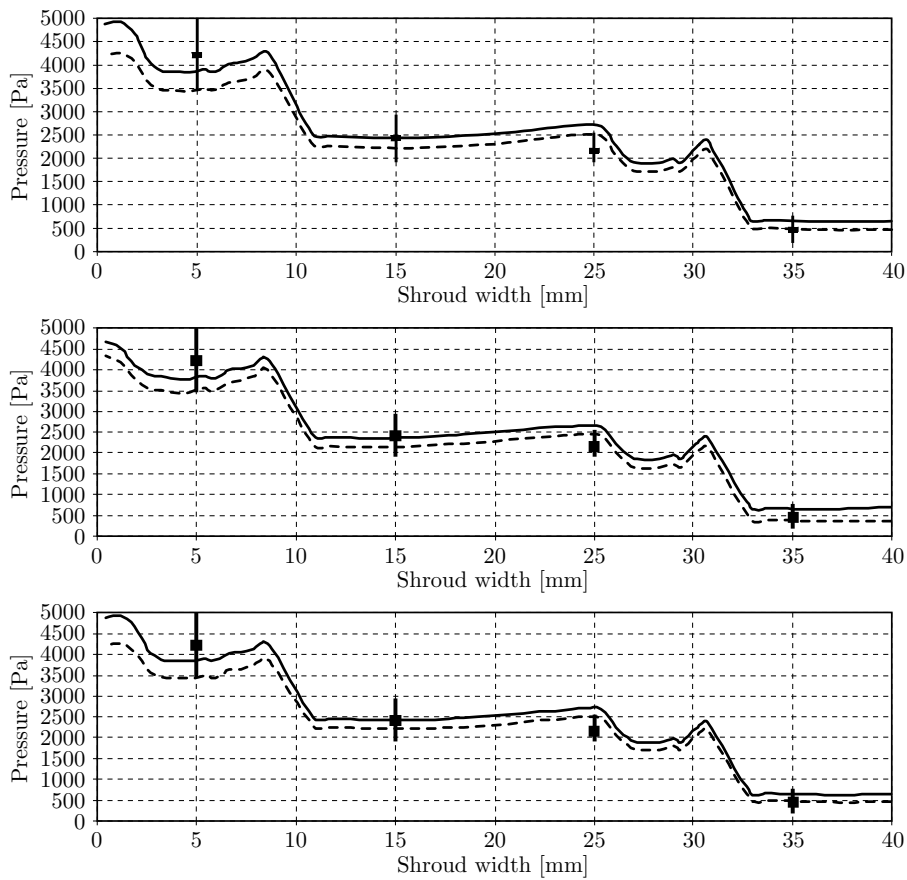

Figure 3. Pressure distribution along the shroud width ($\omega = 566 \text{ rad/s}$): solid line – maximum pressure calculated by the SM method, dashed line – minimum pressure calculated by the SM method, bars – range of pressure changes according to the experimental data (types of grid interfaces from top to bottom: A, B, C)

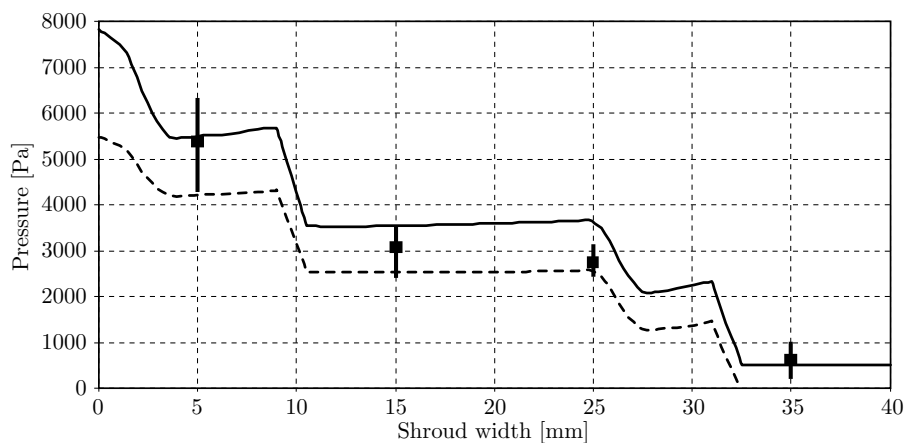

Figure 4. Pressure distribution along the shroud width ($\omega = 645 \text{ rad/s}$): solid line – maximum pressure calculated by the SM method, dashed line – minimum pressure calculated by the SM method, bars – range of pressure changes according to the experimental data

a turbine rotor speed equal to $\omega = 566 \text{ rad/s}$. The calculated pressure amplitudes are much lower than the recorded values. Similar results have been obtained for all the considered types of meshes and grid interfaces (see Figure 3, the types of meshes and grid interfaces have been described in part II). For the higher rotor speed (of 645 rad/s), the calculated pressure changes correspond to the measured ones, as shown in Figure 4. This confirms the statement that the best convergence between the numerical and experimental results is obtained for nominal conditions of machinery performance.

3. Discussion and conclusions

Comparing the 3D numerical calculations with the results of experiments performed in the real turbine, we should take into account some important aspects which influence the results of both methods. In our case we must be aware that:

1. The calculations were performed using an “ideal” geometrical model of the turbine, while according to manufacturing accuracy and working conditions the real turbine geometry is not so perfect and symmetrical. This refers to profile shapes and dimensions, blade heights, cascade spacing, seal dimensions, clearance distributions, *etc.*
2. The calculations were carried out for a turbine rotor located in the center of the casing. During normal turbine work, changes of rotor-stator eccentricity, rotor-stator misalignment and rotor-stator axial gaps are observed (Figure 5). Moreover, the rotor performs quite a complicated trajectory, an example of which is presented in Figure 6.

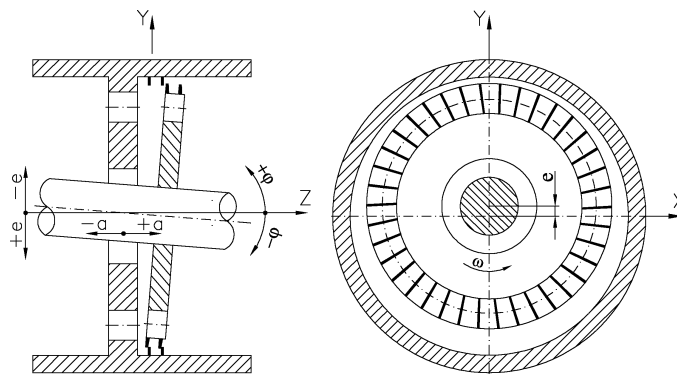

Figure 5. Rotor eccentricity (e), axial gap (a) and rotor-stator misalignment (φ)

3. The calculations were performed assuming uniform, steady-state flow conditions at the stage inlet, while in the experiment the air was delivered to the turbine from a compressor through pipes. The compressor itself generated pressure pulsations, and pressure pulsations occurred at the turbine inlet due to both turbine and compressor work. An example of pressure pulsations recorded at the turbine inlet is presented in Figure 7. Thus, comparing the calculated pressure amplitudes to the measured ones, it should be taken into account that the compressor contributes to the pulsations observed during the experiment.

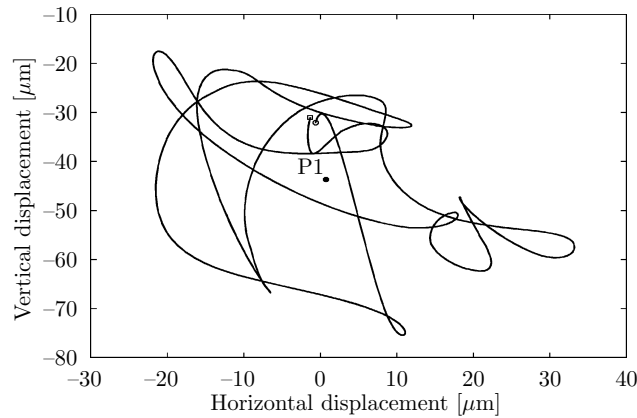

Figure 6. An example of the model turbine rotor trajectory; P1 – mean rotor location

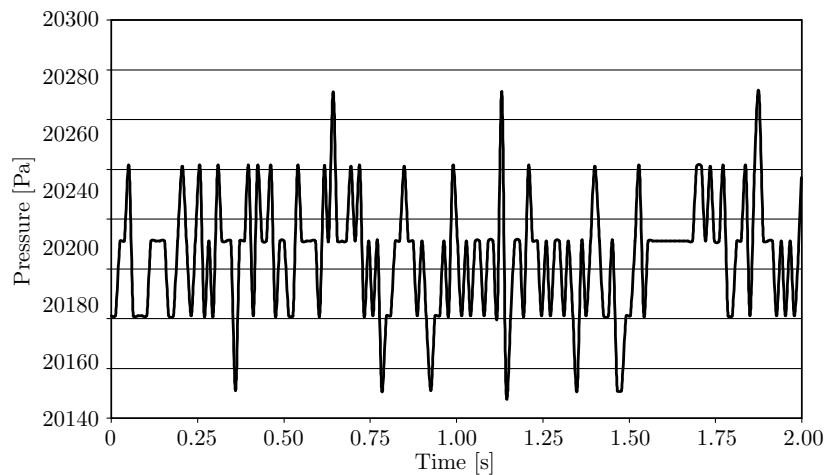

Figure 7. Pressure pulsations at the turbine stage inlet (experimental, $\omega = 645 \text{ rad/s}$)

4. The values recorded during the experiments are also measured with limited accuracy. The accuracy of the whole measuring system should be considered, including the pressure probes, the connecting tubes, the pressure-electric signal converters, the extension cards, the signal transmission system and the computer system of data processing (signal filtering).

Comparing the theoretical results to the experimental data presented in the whole of this paper and taking into account results of many other examined variants, we may draw the following conclusions:

- a) In our case of a turbine stage (relatively short blades), the stage flow calculations carried out using the Sliding Mesh and the Multiple Reference Frame methods with a structural shroud mesh have given results of averaged pressure distribution which correspond well to the time-averaged values of pressure recorded during the experiment. The worst results have been obtained by the Mixing Plane method.
- b) The Sliding Mesh method has given a range of non-stationary pressure fluctuations, which fairly corresponds to experimental data. The best convergence

between the numerical and experimental results has been obtained for nominal conditions of machinery performance, while the greatest differences between the calculated pressure distribution and the measured data have appeared for an unmoving rotor ($\omega = 0$).

- c) 3D numerical methods of flow calculations can cope very well with the task of determining the flow parameters, not only in turbine profile cascades, but also in turbine stage clearances, including shroud seals.

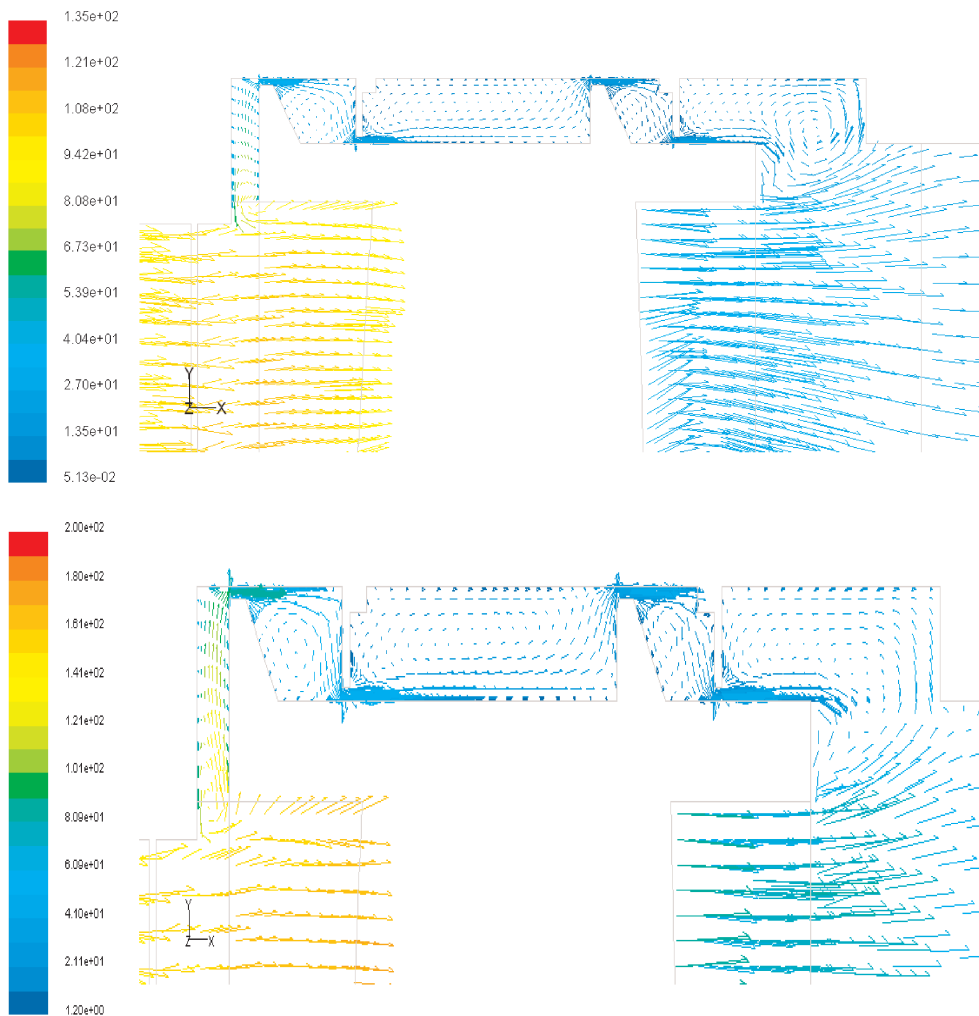

Figure 8. Velocity vectors in the shroud clearance: $\omega = 311 \text{ rad/s}$ (top), $\omega = 645 \text{ rad/s}$ (bottom)

All mechanical probes have limited dimensions and, as a rule, cause some flow disturbances. Thus, it is nowadays impossible to measure the continuous distributions of flow parameters in all elements of turbomachinery systems. For example, the determination of flow velocity vectors in the case of the turbine shroud clearance appears to be a problem of great experimental complication, but we may investigate this phenomenon using numerical calculations. Examples of velocity vectors for



the considered model turbine obtained by the Sliding Mesh method are presented in Figure 8. From the same calculations we may obtain similar distributions of Mach numbers, temperature, density, entropy or loss coefficients. Until the achievements of nanotechnology enable the application of spread sensors in turbomachinery monitoring or research systems, it will be impossible to perform simultaneous measurements of different parameters (like pressure, temperature and velocity) at a single point. Therefore, in many cases 3D calculations can supplement or even replace experiments and provide data which are nowadays very difficult to obtain by experimental methods.

