

Simultaneous handover scheme for IEEE 802.11 WLANs with IEEE 802.21 triggers¹

Przemyslaw Machan, Jozef Wozniak

Gdansk University of Technology, Faculty of Electronics, Telecommunication and Informatics, Narutowicza 11/12, Gdansk, Poland

Abstract Handover performance in wireless networks is important, especially nowadays, when multimedia services are becoming increasingly available over the wireless devices. However, users expect uncompromised mobility when using the service. Thus, the support of multimedia services is not possible if handover is inefficient. At the same time it is clear that a strict separation between IP Layer and the Link Layer results in built-in sources of delay. The paper discusses the IEEE 802.11 and Mobile IPv4 handover performance in practical scenarios. We introduce a new simultaneous handover scheme with IEEE 802.21 triggers. In order to verify the handover performance, simulation experiments have been conducted, whose results are also presented and discussed.

Keywords: *Handover · IEEE 802.11 · WiFi · IEEE 802.21 · Triggers · Mobile IPv4 · Simulation · ns-2*

Introduction

With the growing speed of wireless networks, multimedia services are becoming increasingly available for mobile users. Wireless devices expect service continuity even when they move between points of attachment. Handover performance is a crucial factor for multimedia services support. These types of services are very sensitive to the channel disruption, handover delays or packet losses. All these factors will significantly lower the quality of multimedia services. Because of this, it is not possible to support multimedia services without fast enough and transparent handover procedures.

The network layer protocol - Mobile IPv4 (MIPv4) was designed without any assumptions about the link layer operation and that has negative implications on handover delay. The strict separation between IP Layer and Link Layer (according to the principles of layered architectures design) results in built-in sources of delay. The first reason is that Mobile Host (MH) can only exchange messages with a directly connected Foreign Agent. In consequence the MH cannot communicate with a new FA until layer 2 handover is completed. There are two sources of delay: layer 2 handover and event propagation latency to the IP layer. The second one mainly consists of the Mobile IPv4 Registration process latency. During this period the MH is unable to send or receive any IPv4 packets **Błąd! Nie można odnaleźć źródła odwołania..**

The paper is structured as follows. The next section reviews the related work. The following sections describe handover performance in both IEEE 802.11 and MIPv4. Then the IEEE 802.21 draft is discussed. The description of simultaneous handover procedures for layer 2 and layer 3 is subsequently presented. Finally, simulation test-bed is described and results of simulation experiments are presented and discussed.

Related Work

There is a large number of MIPv4 handover architectures proposed in the literature. One of the most matured extensions to MIPv4 is Low Latency Handoff (LLH) for Mobile IPv4, described in **Błąd! Nie można odnaleźć źródła odwołania..** There are three techniques presented, however the last one is combination of two previous techniques. Pre-Registration handover method allows MH to prepare its registration state in a new Foreign Agent (nFA) via the old Foreign Agent (oFA), before layer 2 handover commences. The second method is a network-assisted handover that can be either network-initiated or mobile-initiated. Link layer triggers are used on both MH and FA to invoke particular handover events.

¹ The work was supported in part by Polish National Center for Research and Development under project PBZ-MNiSW-02/II/2007.

Fast Handover for Mobile IPv4 (FMIPv4) is an adaptation of the Fast Handover for Mobile IPv6. The intention is to utilize the same design for IPv4 networks, however new packet formats for MIPv4 should be standardized. The main idea behind Fast Handover is to obtain a new Care-of Address (CoA) prior to carrying out the handover, and start to use this address just after layer 2 handover is completed. The tunnel is established between the old Access Router (oAR) and the new Access Router (nAR) to enable MH to send and receive data while the handover proceeds. The main assumptions about network architecture, for Fast Handover, are related to layer 2 and layer 3 interactions. The Access Router must be able to extract the IPv4 address of the nAR from the layer 2 address of the new Access Point (nAP). Similarly to LLH, MIPv6 Fast Handover stack receives a layer 2 trigger when a nAP is discovered.

Both methods assume tightly coupling of layer 2 and layer 3 protocols. Using Pre-Registration protocol from LLH is questionable with IEEE 802.11 as the scanning phase prevents MH from selecting the new Access Point (nAP) without leaving our current point of attachment **Błąd! Nie można odnaleźć źródła odwołania..** On the other hand, establishing the tunnel between oAP and nAP delays the MIP registration. When the layer 2 handover is completed, the MH remains registered with the oFA. However, packets destined to the MH arrive at the oFA, are tunneled to the nFA and are delivered through the nAP.

Both LLH and FMIPv4 are strongly dependent on unspecified layer 2 trigger when handover begins. This trigger cannot be trustworthy in IEEE 802.11 networks as handover detection is the protocol bottleneck and can take more than one second. This delay can lead to a situation when MH loses its connection with oAP before the Pre-Registration procedure is completed.

The simultaneous handover for Mobile IPv4 over IEEE 802.11 (SMIPv4) was originally proposed in **Błąd! Nie można odnaleźć źródła odwołania..** The author suggested extending the IEEE 802.11 specification with the MIPv4-Registration-Request (MIPv4-Reg-Req) Information Element (IE) that can be conveyed in IEEE 802.11 Association Request or IEEE 802.11 Reassociation Request frames. As the described procedure adheres to both Association and Reassociation frames we will use the (Re)Association name to refer to both cases. The IE is extracted by nAP and sent to the nFA as Registration Request. When Registration Response is received at nAP it is compacted into MIPv4-Registration-Reply (MIPv4-Reg-Repl) IE and send back to the MH along with (Re)Association Response message. The new Information Elements have the same fields as MIPv4 Registration related messages.

There are some architectural implications related to the proposed solution. Mobile Host MIP layer must be able to pass its parameters to MAC layer on request. Layer 2 must be able to construct MIPv4 Information Elements. Mobile Host puts its Home Address, as the source address, in the MIPv4-Req-Req IE. The destination address is the multicast address of Mobile-Agents, as defined in MIPv4 specification **Błąd! Nie można odnaleźć źródła odwołania..**

IEEE 802.11 Access Point must be able to extract MIPv4 IEs and send them to nFA. If the nFA is co-located with nAP, the MAC and MIP must be able to exchange MIPv4 IEs. If nAP and nFA functionalities are separated nAP operates as proxy for MH. In this paper we will concentrate on the co-located model.

The authors of **Błąd! Nie można odnaleźć źródła odwołania.** optimized the simultaneous handover scheme by allowing the nAP to respond to the Association Request message without waiting on MIPv4 Registration Response. This will eliminate the need for MIPv4-Reg-Repl IE and avoid association timer expiration in MH.

The simultaneous handover scheme has a strong advantage over LLH and FMIPv4 solutions. We will propose the extended solution based on standard layer 2 handover end trigger. The advantage of handover end trigger over the handover begin trigger is that the first one can be determined with a high confidence. Although simultaneous handover procedure has strong architectural dependencies, being the clear and tight coupling of layer 2 and layer 3, it is a necessary compromise for an efficient handover. Moreover, because MIPv4 devices are becoming more and more popular, one can expect IEEE 802.11 and MIPv4 solutions to be available on a "single chip" **Błąd! Nie można odnaleźć źródła odwołania..**

IEEE 802.11 Handover

The handover process has the following phases: detection, search, authentication and association. The handover delay can be expressed by formula (1).

$$T_{802.11} = T_{802.11\text{-detect}} + T_{802.11\text{-scan}} + T_{802.11\text{-auth}} + T_{802.11\text{-(re)assoc}} \quad (1)$$

The detection phase is the time needed for MH to determine when handover must be performed. During this period the network connection can deteriorate or become unavailable. When the network configuration forces the MH to change the AP before the channel condition deteriorates the detection time will not affect handover delay. However, network configuration is not always optimized for handover performance. IEEE 802.11 standard does not provide a shared control channel for this information distribution, so the client must scan channels for prospective APs. The next step is the handover execution: authentication and association; these procedures are defined in the IEEE 802.11 standard. If stations support the IEEE 802.11e extension the handover can be delayed with QoS messages. Moreover, if WPA or WPA2 procedures are in use the key derivation and exchange messages will additionally influence the handover delay.

The described delays differ between implementations and depend on network equipment interoperability and environment conditions **Błąd! Nie można odnaleźć źródła odwołania..** Empirical studies were conducted to estimate the values of parameters **Błąd! Nie można odnaleźć źródła odwołania.****Błąd! Nie można odnaleźć źródła odwołania.****Błąd! Nie można odnaleźć źródła odwołania.**; the corresponding data was collected and is shown in Table 1.

Table 1. IEEE 802.11 Handover procedure delays

Parameter	Value
$T_{802.11-detect}$	300 – 600 ms
$T_{802.11-scan}$	58 – 400 ms
$T_{802.11-open-auth}$	Less then 10 ms
$T_{802.11-(re)assoc}$	Less then 10 ms

The detection phase delay differs when handover is station-initiated or network-initiated. The AP can initiate handover by sending IEEE 802.11 Deassociation Request message. However, in a typical case the station decides to handover when transmission conditions deteriorate. For station-initiated handover the length of detection phase depends strongly on station algorithm.

The explanation for the maximum detection time presented in Table 1 is as follows. If the transmission fails the station assumes collision and retransmits packet at a lower data rate. If the transmission remains unsuccessful, the station assumes signal fading and sends IEEE 802.11 Probe Request to verify the link state. After several unanswered requests the station starts scanning phase.

Generally, there are two groups of detection algorithms, based on: either failed transmissions or received signal strength reported by PHY layer **Błąd! Nie można odnaleźć źródła odwołania..** An example of the algorithm that belongs to the first class is a case when station detects a loss of the connection with an old Access Point (oAP) after three subsequent frames are not sent successfully. In this case T_{detect} refers to a time needed to send three frames. If the station only receives data or does not send or receive data at all, it can monitor reception of IEEE 802.11 Beacon frames. As typical Beacon frame interval is 100 ms the detection time can be estimated as 300 ms.

The algorithms based on signal strength utilized Received Signal Strength Indicator (RSSI) provided by PHY layer – as defined in IEEE specification **Błąd! Nie można odnaleźć źródła odwołania..** The MH can also use SNR metric. However, a technique to acquire noise level is not covered by the standard. The detection methods based on signal strength typically do not provide the accepted performance because of dynamic nature of wireless channel. Although a number of techniques to shorten detection time is provided in the literature **Błąd! Nie można odnaleźć źródła odwołania.****Błąd! Nie można odnaleźć źródła odwołania..**, this is one of the most important bottlenecks.

The active scanning algorithm is described in IEEE 802.11 standard **Błąd! Nie można odnaleźć źródła odwołania..** This procedure is responsible for a significant part of the handover delay. The station sends Probe Request over a particular channel and waits for either medium busy detection within MinChannelTime or MaxChannelTime timer expiration. The procedure is repeated for each channel to be scanned. However, the standard does not define the timer values and the number of channel to be scanned.

$$T_{802.11-scan} = \sum_{c=1}^{NumChannels} (1-P(c)) \cdot T_{MinChannelTime} + P(c) \cdot T_{MaxChannelTime} + T_{switch} \quad (2)$$

The scanning delay can be represented by equation (2). T_{switch} parameter refers to the switch time to a new frequency, resynchronize and start demodulating packets in a new channel. $P(c)$ is

the probability that at least one AP will send Probe Response on the selected channel. The described timers are different between implementations and depends on network equipment interoperability and environment conditions.

The number of algorithms is presented in the literature to limit the scanning delay. For example, the authors of SyncScan **Błąd! Nie można odnaleźć źródła odwołania.** configure wireless network that the interval between Beacon frames in neighbour channels is constant. According to this scenario Mobile Host can passively scan the next channel in the limited time.

The time for open authentication and reassociation procedures can be modeled as a trivial frame exchange. The measurements show that each procedure takes no more than 10 ms.

MIPv4 Handover

The MIPv4 handover delay (T_{MIPv4}) is expressed by equation (3). The delay consists of detection delay, new CoA acquirement and redirection time **Błąd! Nie można odnaleźć źródła odwołania.**

$$T_{MIPv4} = T_{MIPv4\text{-detect}} + T_{MIPv4\text{-coa}} + T_{MIPv4\text{-redirect}} \quad (3)$$

The detection time is defined as an interval between the time instance when link layer connection is reestablished with a new AP and the beginning of CoA acquisition procedure. In the next step the station needs to retrieve information about a new care-of-address and the default gateway to resume communication on the new subnet. The time for this procedure is referred to as $T_{MIPv4\text{-coa}}$. Once the required IP level information is obtained, the station redirects its upstream and downstream flows ($T_{MIPv4\text{-redirect}}$). The timing of MIPv4 handover is presented in Fig. 1.

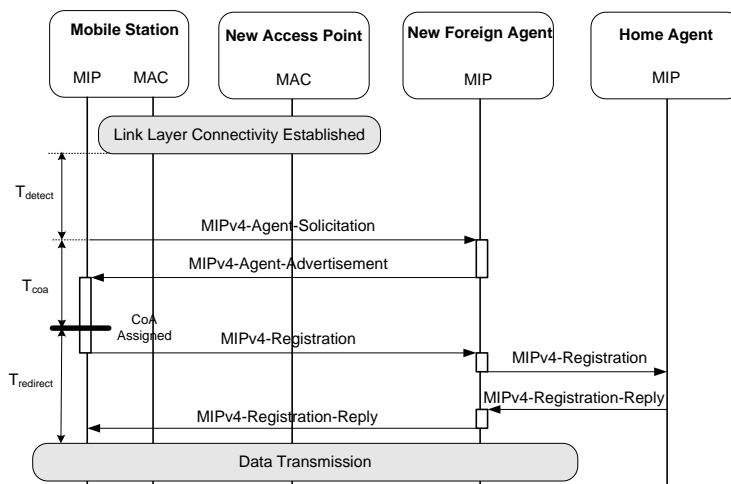

Fig. 1 MIPv4 Handover Timing

To evaluate the handover performance, the more detailed assumptions must be accepted. Detection time depends on the move detection algorithm used. There are three mechanisms proposed for Mobile IPv4 draft: Lazy Cell Switching (LCS), Prefix Matching (PM), and Eager Cell Switching (ECS) **Błąd! Nie można odnaleźć źródła odwołania.** In our experiment the mobile station uses the ECS method. The station records the lifetime received from Agent, with which MH is currently registered. If the lifetime expires until the next Agent Advertisement (AA) is received the station assumes that connectivity with this Agent is lost and the station should perform CoA retrieval procedure. However, MH can attempt to register with another agent if Agent Advertisement from nFA is received before the lifetime of the current Agent expires. Assuming that the advertisement lifetime is T_{AD-LT} and Agent Advertisements period is T_{AD} the detection time is presented by equation (4). The assumption behind equation (4) is that layer 2 handover is instant. In fact the MIPv4 detection period begins along with IEEE 802.11 handover process, but the first is typically longer.

$$T_{MIPv4\text{-detect(LCS)}} = \frac{\min(T_{AD-LT}, T_{AD})}{2} - \frac{\min(T_{AD-LT}, T_{AD})^3}{6T_{AD-LT}T_{AD}} \quad (4)$$

The evaluation of detection time depends directly on Agent Advertisement period. Advertisement lifetime should be at least three times higher than AA period. The AA rate was initially limited to one per second **Błąd! Nie można odnaleźć źródła odwołania.** to save the wireless bandwidth. However, with the increasing wireless network speed and the demand for seamless handover, the AA period can be lowered. The authors assumed AA period to be one second. Both $T_{\text{MIPv4-coa}}$ and $T_{\text{MIPv4-redirect}}$ can be modeled as frame exchange and not introduce a significant delay to the MIPv4 handover procedure. The handover phase delays are collected in Table 2.

Table 2. MIPv4 Handover procedure delays

Parameter	Value
$T_{\text{MIPv4-detect(LCS)}}$	100 – 1000 ms
$T_{\text{MIPv4-coa}}$	Less than 10 ms
$T_{\text{MIPv4-redirect}}$	Less than 40 ms

IEEE 802.21 Framework

The IEEE 802.21 standard introduces Media Independent Handover (MIH) Function that is considered a shim layer in the network stack of both network node and the network elements that provide mobility support **Błąd! Nie można odnaleźć źródła odwołania.** MIH Function provides abstracted services to the upper layers and communicates with lower layers through technology-specific interfaces. Handover control, handover policies and other algorithms involved in handover decision-making are handled by communication system elements and are not part of the IEEE 802.21 specification. The key components of IEEE 802.21 architecture are presented in Fig. 2.

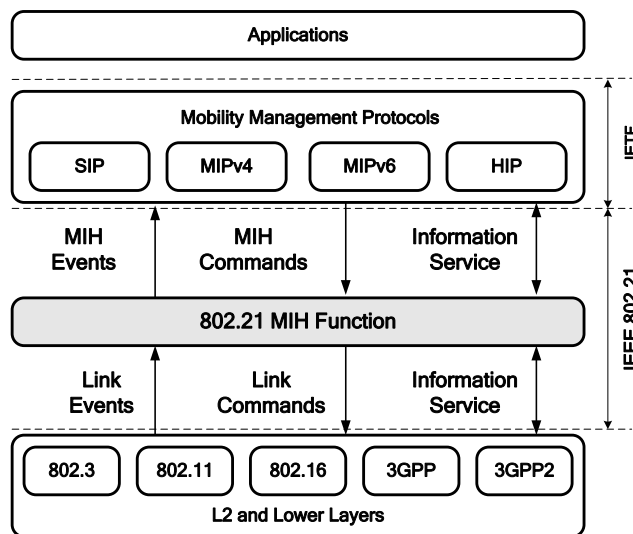

Fig. 2 IEEE 802.21 architecture

The scope of IEEE 802.21 standard will include a universal architecture that provides service continuity while a MN switches between heterogeneous link-layer technologies. The MIH Function provides the following services: Media Independent Event Service (MIES), Media Independent Command Service (MICS), and Media Independent Information Service (MIIS).

Media Independent Event Service

The events are mainly divided into two categories: Link Events and MIH Events. Link Events are defined as originated in the layers below MIH Function and typically terminate at MIH Function. The latter are events propagated by MIH Function to upper layers. MIES provides both local and remote events and triggers to the upper layers of MN. Event model is based on subscriptions basis, the upper layer can define events that must be notified. Media Independent Event Service was designed to support both node-initiated and network-initiated handover. Link Events can be generated on local machine and passed to MIH Function or sourced on remote host and transported via MIES to the host when handover algorithm is located on. The security



considerations are important for such a protocol. The multicast events must be supported because there can be a number of hosts registered for the same event.

There can be two general types of events: Link Events and MIH Events. Both event types traverse from a lower to higher layer. Link Events originates at network layers below the MIH Function and terminate at the MIH Function. MIH Events are propagated by the MIH Function to the upper layers. Link Events may be forwarded to the upper layers, with or without processing, and become MIH Events. Both types of events are illustrated in Fig. 3.

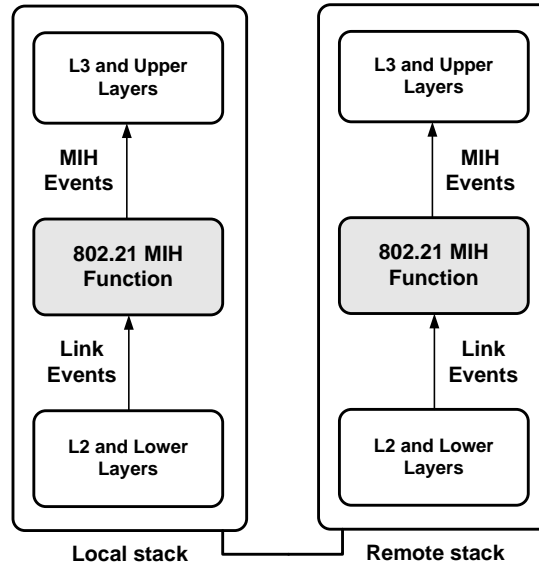

Fig. 3 MIH and Link Events

Media Independent Event Service can support the following specific event types:

- MAC and PHY State Change events relates to network layer state change, e.g. “Link Up” event.
- Link Parameters events relates to the change of Link Layer parameter. The event can be generated both synchronously and asynchronously. The example of Link Parameter event is “Link Parameter Change”.
- Predictive events describe the probable change of Link Layer parameter in near future. The change is anticipated on the base of past and current conditions. Since that type of events relate to the future the event canceling mechanism is required. Predictive events must have at least two parameters: time boundary and predicted event confidence.
- Link Synchronous events give indications of precise timing of L2 handover events that are useful to upper layer mobility management protocols. Link Synchronous events are deterministic and relates to the present Link Layer condition.
- Link Transmission events relate to the transmission status of the higher layer data. That type of events can be used to enhance buffer maintenance. For example during the handover process some packets are usually lost after the connectivity is restored because they are stored in L2 layer buffers and are not correctly addressed or fragmented. Link Transmission events may support process of low-loss handover by providing a fast indication on whether a particular frame was transmitted or not. The upper layer can quickly prepare for selective retransmission of the lost data, without waiting for a retransmission timer expiration or end-to-end feedback.

Event registration differs for Link events and MIH Events. Link Events registration is performed by MIH Function with L2 Layer and determinates events that particular link can provide. MIH Users (i.e L3 and Upper Layers) register MIH Events with MIH Function.

The Media Independent Event Service is the entity responsible for handling local and remote events. The assumption is that handover may be initiated either by a mobile node or a network. In consequence events that may indicate handover may originate at the mobile node or at the network point of attachment. The reason for the event may be a node mobility, state change of the environment or network management. Thus, a transport protocol for both local and remote events is required as every event may have the multiple recipients.

Media Independent Command Service

MICS provides functions to gather the status of links and invoke commands to control handover process. The commands receiver can be both local and remote. Typical commands are MIH Poll used to poll physical links or MIH Configure used to configure connected links. As with events, MIH Commands are sent from upper layer to MIH Function and Link Commands propagates from MIH Function to link layers. Upper layers can utilize MIH commands to determine status of links or to configure optimal handover policy.

Media Independent Information Service

MIIS defines access to network database that contains information used to aim handover process. The network information is stored in platform independent description language and can be static or dynamic. Static information examples are network and provider name, whilst dynamic information comprises a channel, security configuration and MAC addresses.

To describe network MIIS provides a set of information, information structure and its representation and a query/response type algorithm. The information service provides access to both static and dynamic network information. The database should contain not only L2 information but also parameters describing higher layers. The common way MIIS uses to present information across different technologies are XML and ASN.1.

Simultaneous Handover with IEEE 802.21 triggers

The concept of simultaneous handover assumes tight coupling of layers 2 and 3 protocols that should result in improved handover efficiency. In the paper we extend the procedure proposed in **Błąd! Nie można odnaleźć źródła odwołania.** by the usage of the standard MIH Link Up trigger. This will make it possible to simplify the implementation of protocol on MH. MIPv4 instance does not need to pass parameters to MAC layer and can operate transparently. The handover procedure for MIPv4 over IEEE 802.11 is depicted in Fig. 4.

The handover procedure begins when Mobile Host MAC detects the handover that is marked as L1 Trigger, i.e. layer 1 trigger. The trigger is not defined in IEEE 802.11 standard, in consequence differs between implementations **Błąd! Nie można odnaleźć źródła odwołania.** The trivial trigger is received signal strength drop below the receive threshold. The more complex implementation may utilize beacon statistics, the number of retransmissions, dropped frames statistics, etc. The active scanning procedure is invoked in the next step and nAP is selected. The station performs authentication procedure. To trigger simultaneous handover Link Up event is passed to the MIH layer and propagated to the MIH client (MIP). When the event is received the Mobile IPv4 layer sends the Registration Request message. The message is addressed to the broadcast address of all foreign agents. The RR message is transformed into Registration-Request-IE in the MAC layer. The nAP extracts MIPv4 Registration Request and sends it to the nFA. The access point responds with Reassociation Response message. The other operations are the same as in the base protocols.

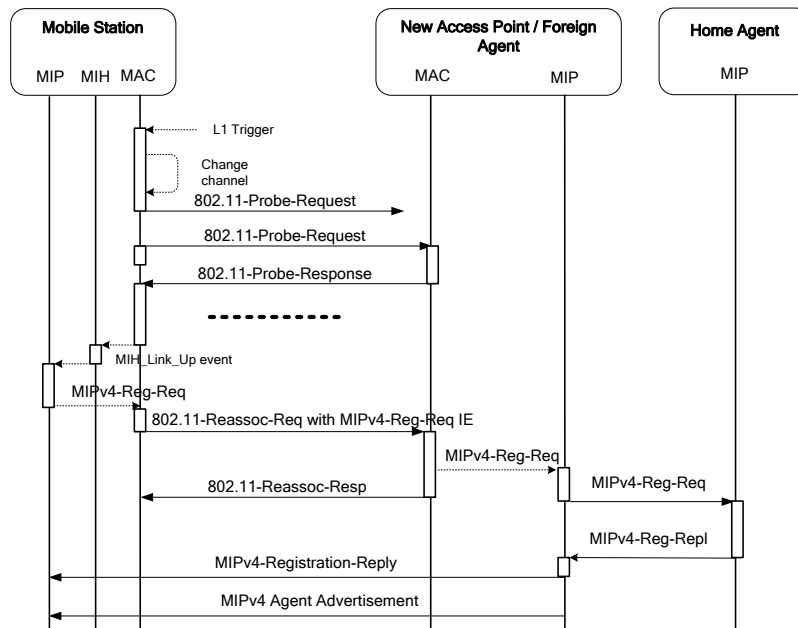

Fig. 4. Simultaneous handoff for IEEE 802.11 and MIPv4

Test-bed Implementation

The model of simultaneous handover with our extension was implemented in widely used ns-2 simulator. We based on handover support developed for Seamless and Secure Mobility project **Błąd! Nie można odnaleźć źródła odwołania..** For the purpose of the simulation the model of a “city market” was created, as presented in Fig. 5. There are three Mobile Routers (MR), each of them have both IEEE 802.11 Access Point and MIPv4 Foreign Agent functionalities. The stations move within an area of 180 x 60 meters with the velocity of 1m/s. The number of stations and traffic load was changed to verify correctness of the protocol operation. The experiments were conducted using 10 different, random mobility patterns.

Mobile stations were downloading CBR stream using 1000-bytes-long fixed-size UDP packets. The reason for using UDP, and not TCP, is that TCP infers congestion from packet loss and scales back its send window accordingly. The experiments aimed at how throughput, handover delay and packet loss are affected by handover algorithms, rather than due to protocol-induced throughput reductions. Although TCP is used for many network applications, the majority of real-time multimedia services are based on UDP.

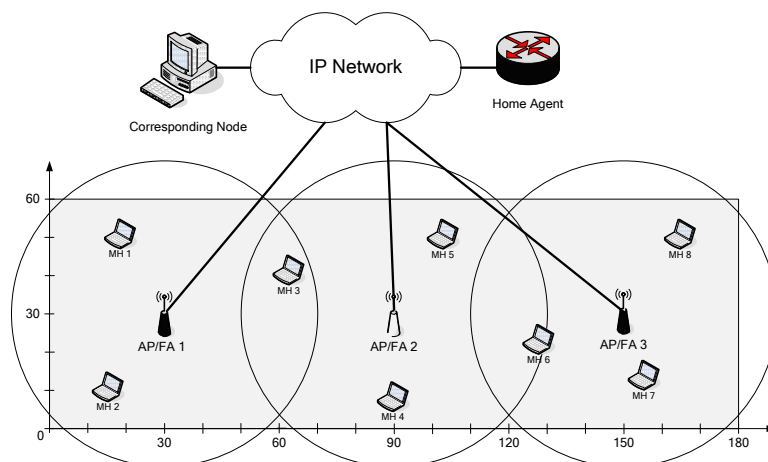

Fig. 5. Simulation scenario for simultaneous handover

Simulation Results

The experiments were conducted to compare the handover performance using original and simultaneous handover procedures. The handover delay measurements are presented in Fig. 6 and 7. Station number in the experiments is marked in the legend as n . The delay was measured as time between last packet received by MH through the old MR and the first packet received via the new MR. The handover delay does not depend on the network load or the number of stations, but results were presented for consistency. The regular handover scenario is implemented without any handover-optimized mechanisms. MIPv4 handover proceeds independently of IEEE 802.11 handover. The variation of handover delay for regular handover is higher than using simultaneous handover. The reason is that regular MIPv4 handover time is dependent on T_{AD-LT} and T_{AD} timers as described previously.

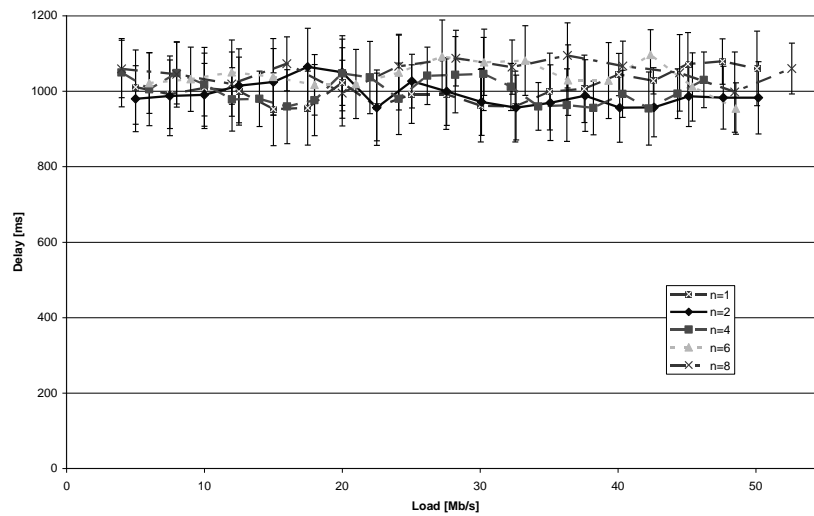

Fig. 6. Handover delay vs. network load in the regular algorithm

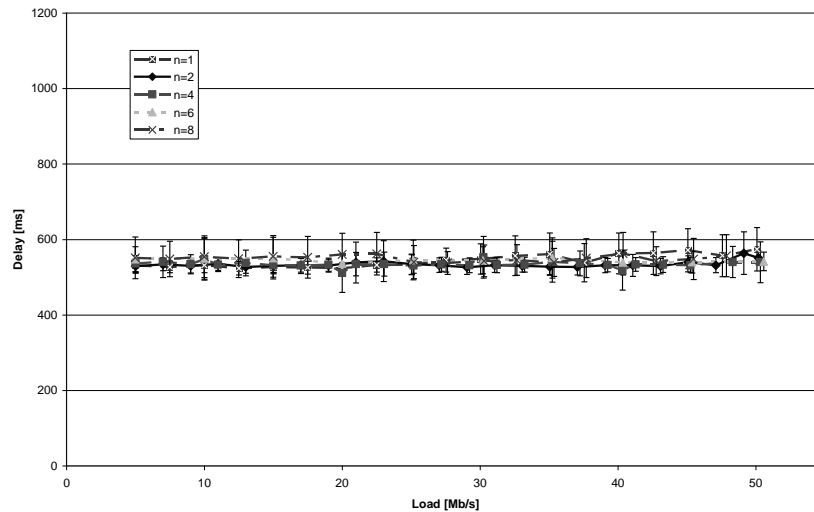

Fig. 7. Handover delay vs. network load in simultaneous handover scenario

The detection delay ($T_{SMIPv4-detect}$) is, in the case of simultaneous handover procedure, the time between the IEEE 802.11 (Re)Association Response message is received by MH and MIH Link Up trigger is received by MIPv4 layer. The detection delay strongly depends on internal MH design and its value, in our experiments, was below 1 ms. In turn, the total delay for simultaneous handover ($T_{SMIPv4-802.11} = 550$ ms) was about 45% lower when compared with the regular scenario ($T_{MIPv4-802.11} = 1000$ ms). However, the value of $T_{SMIPv4-802.11}$ is still not accepted for multimedia services. Using simultaneous handovers the layer 3 handover delay T_{SMIPv4} is optimized to less

then 30 ms, compared to $T_{MIPv4} = 450$ ms when using the regular protocols. In further investigations we plan to optimize $T_{802.11}$ - the layer 2 handover.

The results of handover delay can be roughly compared with LLH and FMIPv4 performance. The simulation results presented in **Błąd! Nie można odnaleźć źródła odwołania.** show that packets sent during the handover with LLH or FMIPv4 experience the delay not longer then 100 ms. Although the simulation scenarios were different, we can estimate that SMIPv4 handover delay is shorter compared with the LLH and FMIPv4 protocols.

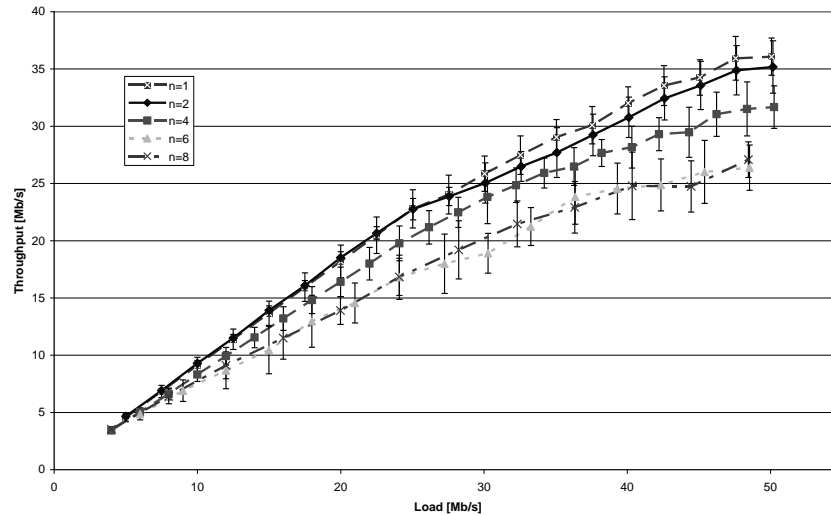

Fig. 8. Data throughput vs. network load in the regular handover scenario

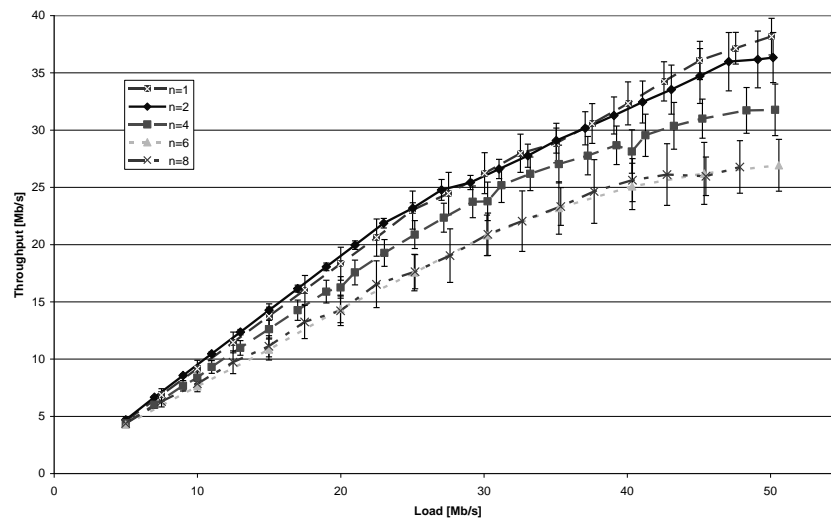

Fig. 9. Data throughput vs. network load in the simultaneous handover scenario

The data throughput variations vs. network load are presented in Fig. 8 and Fig. 9. The charts show only user data; protocol messages were not measured. The effective throughput of the network with SMIPv4 handover is slightly higher when compared to MIPv4 case because of the shorter handover delays.

Protocol messages load is depicted in Fig. 10 and Fig. 11. The examples of messages are IEEE 802.11 Management and Control frames or MIPv4 Registration frames. That type of traffic is referred as signal traffic and consists of all the other messages apart from messages that convey user data in MIPv4 and IEEE 802.11 protocols. The signal traffic is slightly higher in the modified scenario comparing to the basic algorithm. The difference is related to simultaneous handover extensions – additional information elements added to the beacon, probe response and association and reassociation messages in the IEEE 802.11 protocol. However, the user data throughput is increased and handover delay is limited when simultaneous handover is used. That leads to the conclusion that higher signal load is a fair cost for improved protocols benefits.

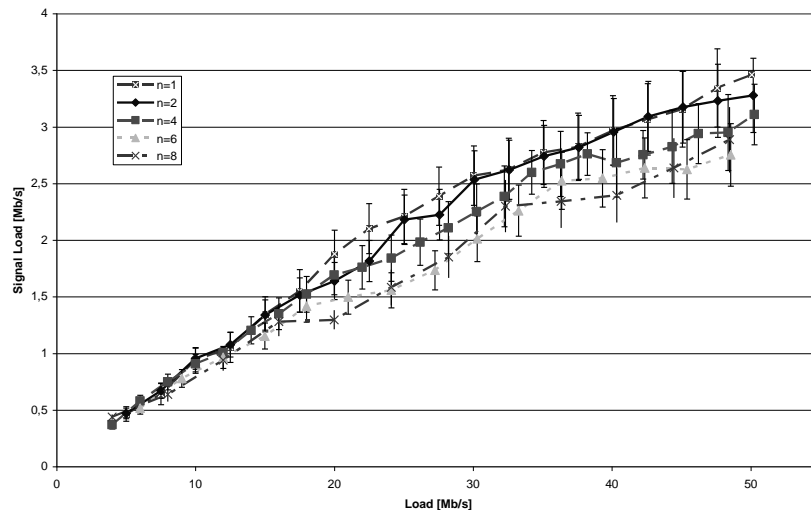

Fig. 10. Signal traffic load vs. network load in the regular handover scenario

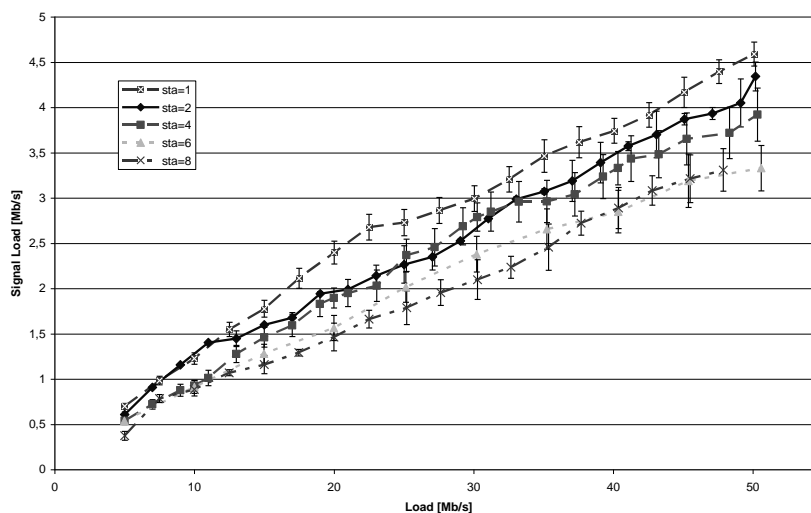

Fig. 11. Signal traffic load vs. network load in the simultaneous handover scenario

Conclusions

The article presents a handover performance analysis with respect to the overall delay. The delay components in each layer were selected and described. The main interest was in the comparison and performance analysis of MIPv4 protocols. Existing protocols that claim to support fast handovers are based on the layer 2 trigger indicating handover begin. This IEEE 802.21 trigger is unreliable when handover is typically station-initiated, as is the case in IEEE 802.11. We have proposed and described the simultaneous handover procedure that uses the layer 2 handover end trigger. The main advantage of our solution over the previously described is that handover end can be trustfully determined in IEEE 802.11 networks. The simultaneous handover protocol was modeled using ns-2. The results show that layer 3 handover was optimized; the total handover delay was shortened from 1050 ms to 550 ms in typical scenarios.

References

1. Blondia, C., Casals, O., Cerdà, L., Van den Wijngaert, N., & Willems, G. (2004). Performance evaluation of layer 3 low latency handoff mechanisms. *Mobile Networks and Applications*, 9, 633–645.

2. De Cleyn, P., Van den Wijngaert, N., Cerdà, L., & Blondia, C. (2004). A smooth handoff scheme using IEEE802.11 triggers—design and implementation. *Computer Networks*, 345–361.
3. El Malki, K. (Ed.) (2007). Low-latency handoffs in mobile IPv4, RFC 4881.4. Goswami, S. (2003). Simultaneous handoff of mobile-IPv4 and 802.11 (Internet Draft).
5. IEEE Comp Society (1999). Part 11: Wireless LAN medium access control (MAC) and physical layer (PHY) specifications.
6. IEEE Comp Society (2007). P802.21/D05.00: Draft IEEE standard for local and metropolitan area networks: Media independent handover services.
7. Love, J. (2005). Thinking big: These single-chip switch processors take on enterprise wired/wireless LANs. <http://www.eeproductcenter.com/test-measure/review/showArticle.jhtml?articleID=60402054>. Accessed 24 March 2008.
8. Matusz, P., Machan, P., & Wozniak, J. (2003). Analysis of profitability of inter-system handovers between IEEE 802.11b and UMTS. In *IEEE conf. on local comput. netw.*
9. Mishra, A., Shin, M., & Arbaugh, W. A. (2003). An empirical analysis of the IEEE 802.11 MAC layer handoff process. *ACM SIGCOMM Computer Communication Review*, 93–102.
10. Mun, Y., & Park, J. (2004). In LNCS: Vol. 3043. The layer 2 handoff scheme for mobile IP over IEEE 802.11 wireless LAN (pp. 1144–1150). Berlin: Springer.
11. NIST (2007). Seamless and Secure Mobility. <http://www.antd.nist.gov/seamlessandsecure.shtml>. Accessed 01 June 2008.
12. Perkins, C. (Ed.) (2002). IP mobility support for IPv4. RFC 3344.
13. Ramani, I., & Savage, S. (2005). SyncScan: Practical fast handoff for 802.11 infrastructure networks. In *IEEE infocom conf.*
14. Rückforth, T. (2004). AAA context transfer for fast authenticated inter-domain handover. Bern: Swisscom SA Innovations Broadband Network.
15. Vatn, J. O. (2000). Improving mobile IP handover performance. Stockholm: Royal Institute of Technology.
16. Vatn, J. O. (2003). An experimental study of IEEE 802.11b handover performance and its effect on voice traffic. Stockholm: Royal Institute of Technology.
17. Velayos, H., & Karlsson, G. (2004). Techniques to reduce the IEEE 802.11b handoff time. In *IEEE Int. Conf. on Commun.*