

Smart heating system for home extending utilization of renewable energy sources

Adam Bujnowski

*Faculty of Electronics,
Telecommunications and Informatics
Biomedical Engineering Department
Gdansk University of Technology
Gdansk, Poland
adabujno@pg.edu.pl*

Jan Wajs

*Faculty of Mechanical Engineering
Department of Energy and
Industrial Apparatus
Gdansk University of Technology
Gdansk, Poland
janwajs@pg.edu.pl*

Kamil Osinski , Mariusz Kaczmarek

*Faculty of Electronics,
Telecommunications and Informatics
Biomedical Engineering Department
Gdansk University of Technology
Gdansk, Poland
kamilosinski1@gmail.com, markaczm@pg.edu.pl*

Marcin Jewartowski, Jan Stasiak, Waldemar Targanski

*Faculty of Mechanical Engineering
Department of Energy and
Industrial Apparatus
Gdansk University of Technology
Gdansk, Poland*

marjewar@pg.edu.pl, jstasiak@pg.edu.pl, wtargans@pg.edu.pl

Abstract—In the paper a modern approach to smart home heating is presented. Proposed solution utilizes at least two low-polluting energy source technologies. The main idea is to connect well known ecological energy sources in a way that they can support each other and minimize risks of failure when using single system or even both of them but managed in separate way. Considered energy technologies, used separately, have disadvantages, that can be reduced by smart interconnection between them. We are showing that adequately selecting supplementary energy sources can benefit in lower pollution and lower costs of system usage including higher reliability.

Heating systems, heat pump, Solar energy, smart control, IoT

I. INTRODUCTION

Increase of environmental awareness of inventors with the large legal and political pressure put on a reduction of the costs of energy led companies to investigate area of latest technologies for domestic heating systems. The majority of domestic energy consumption is related to maintaining so called heat comfort. This means heating or cooling interiors and preparation of warm water for hygienic purposes.

Objectives and technological problems to be solved in relation to climate change, are among the others depletion of fossil fuels resources [1] and the agenda for development of the alternatives energy environment saving model based on renewable energy resources (RES) and stabilizing CO₂ and other pollutants concentration in the atmosphere.

Taking into account the European Technology and Innovation Platform on Renewable Heating and Cooling Programme

This work was partially supported by Statutory Funds of Electronics, Telecommunications and Informatics Faculty, Mechanical Faculty, Gdansk University of Technology and by BMB Santech Ltd. company.

(ETIP-RHC) SANTECH Ltd. with Gdansk University of Technology (GUT) and financial support from Polish Agency for Enterprise Development (PARP) is developing hybrid and fully automatic control system for building heating. It is assumed that majority of utilized energy will be the solar one. Unfortunately in medium climate there is demand for alternative energy sources utilized in colder period, where solar energy is not sufficient. Authors decided to utilize heat pump as it is regarded as low polluting heat source.

Using energy more efficiently should lead to a financial gain whether this is achieved by individual reducing of heating bills thanks to better thermal insulation and using RES or energy recovery schemes [2]. In this paper we propose smart connection of solar collectors and a heat pump to extend applicability of both sources. In particular, we propose the controller and the control algorithm for the system.

Proposed control algorithm is designed to utilize renewable energy sources first. In addition with connection to the weather forecast station over the Internet it is possible to predict changes of the outside temperature in order to prepare building for increased energy demand. User can interact with the system programming thermal comfort remotely and additionally being informed about energy utilization in smart way - eg. by the application's background color.

The proposed work plan is related to following tasks:

- fundamental studies on more efficient system for house heating with the use of different kinds of energy sources,
- development of modern technology and knowledge in many scientific and engineering issues in the field of energy management,
- implementation of sustainable and more economic co-generation system for heat, power and hot water heating

production,

- development of an IT tools for optimization and on-line control of energy management.

The rest of the paper is structured as follows. Section II presents low polluting energy sources that are used in the study. In section III we propose the methods while Section IV demonstrates initial results. The paper is finalized by conclusion.

II. THE LOW POLLUTING ENERGY SOURCES

Development of energy-efficient systems for domestic heating sector with solar collectors and heat pumps has taken an accelerated pace in recent years. If there is any extra demand for heat it is supplied by electric heater or gas/oil boilers as an alternative solution.

A. Solar energy

Sun is a star located in the center of the Solar System. Distance from the Sun to the Earth is about $149,6 \cdot 10^6 km$. In each second sun is emitting about $3.8 \cdot 10^{26} J$ of energy. The temperature of the solar sphere is about 5800K. Solar constant is annually average energy flux from the solar radiation calculated outside Earth atmosphere. It's value is about $G_{SC} = 1361 W/m^2$ and it varies accordingly to solar activity [3]. After passing the Earth's atmosphere it's amount is reduced to about $G_s = 1 kW/m^2$ for Poland. This is approximate maximal value that can be altered by clouds, sun positions, atmospheric clarity etc.

The amount of energy delivered by the solar panel can be estimated as:

$$Ed = G_s \eta_d \eta_t \eta_l A \cos(\phi) \cos(\theta) \quad (1)$$

where A - absorber area, η_d - efficiency of energy transfer from panel to the system - heat exchanger dependent, η_t - efficiency of absorption - solar panel dependent, η_l - losses due to convection - solar panel construction ϕ - elevation angle - solar panel alignment towards the Sun (elevation), θ - rotation angle - depends on the daytime.

It is estimated that for area of Poland cumulative energy obtained from solar panels ranges from $2999 MJ/m^2$ ($833 kWh/m^2$) to $4316 MJ/m^2$ ($1199 kWh/m^2$). Values are approximate and depend on atmospheric conditions in particular year [4].

From eq. 1 one can conclude that to maximize amount of the energy a good quality solar panel, installed at optimal elevation angle towards south should be selected. It is also clear that amount of received energy is a function of the solar panels area. By increasing the installation area amount of received energy is increased too.

In typical solar installations for residential buildings the area of solar collectors is determined based on demand for domestic hot water. Not all of that demand can be covered by solar energy due to low solar radiation during winter.

On the other hand increase of solar collectors area in order to use them also to cover some part of demand for heating during cold months causes problems during summer, due to

very low demand for heat. This situation is even dangerous - energy that is not used causes overheating of the installation and its malfunction. Temperature rise evokes pressure rise in the installation resulting in leakage of installation fluid (usually glicol).

Determination of optimal from the economical point of view size of solar collectors is not easy task and is a field of research, that can be found in literature [5] [6].

B. Photovoltaics

Another way of solar energy utilization is photo-voltaic (PV) installation. In this situation solar radiation is converted to electric current. Electrical energy can be used for heating purposes as well. Unfortunately efficiency of modern PV panels is much lower than for liquid heat exchangers. To receive the same power as in solar panels PV installations use more space and thus they are more expensive. The biggest advantage of the PV installation is ease of control.

Thee PV panels are utilized for electricity production. It is attractive option, but requires larger area of panels in compare to solar collectors. One of major disadvantages of PV panels is efficiency reduction due to panel heating. There are research pending on various strategies of PV panels cooling. It can be done by means of solar collectors [7].

C. Wind energy

Wind is yet another attractive source of energy. However its utilization becomes popular from one point of view but also have environmental impact. This caused restriction in localization of the high power wind stations. Stations without such restrictions have to little power in order to be considered for heating purposes.

D. Heat pumps

A heat pump is a device that transfers heat energy from a low temperature source of heat a "heat sink" with higher temperature so it moves thermal energy in the opposite direction of spontaneous heat transfer, by absorbing heat from a cold space and releasing it to a warmer one. For this purposes this device uses a small amount of external energy [8], [9].

The lower heat source of heat pump should have proper capacity, stable temperature during a year with possibly high value. Commonly used lower heat source is the ground surrounding the building. Vertical (BTES) and horizontal (GTES) ground heat exchangers can be used. Horizontal ones are less expensive and reliable enough in typical conditions. Capacity of ground heat exchangers depends on the type of soil and its humidity. Sometimes there is a threat of not sufficient ground regeneration during summer, after intensive exploitation in winter.

Major disadvantages of the heat pump are:

- electrical energy utilization to drive the compressor,
- synthetic refrigerant application and possibility of leakages,
- relatively high initial cost of the investment, requiring borehole drilling or heavy soil works



Major advantage of heat pump installation is its economical efficiency. The coefficient of performance (COP) factor is calculated as:

$$COP_{\text{heating}} = \frac{\Delta Q_{\text{hot}}}{\Delta A} \leq \frac{T_{\text{hot}}}{T_{\text{hot}} - T_{\text{cool}}} \quad (2)$$

where ΔQ_{hot} is the amount of heat delivered to a hot reservoir at temperature T_{hot} , ΔA is the compressor's consumed energy and T_{cool} is cold reservoir temperature.

The values of COP_{heating} are always higher than 1, typically for ground exchanger and hot reservoir temperature at level 35°C it ranges between 4 and 5. It means that in comparison to resistive heater it is much more economic [10].

If the ground is used as the lower heat source, efficiency and properties of whole system depend among others on soil properties [11]. Additionally in several cases soil parameters change during usage period of the system. Problems can arise when soil can not regenerate energy during summer period [12], [13]. There are present methods of utilizing excess of heat from solar panels in summertime by heating swimming pools or in similar ways [14].

E. Hybrid, multi-source system

Currently proposed solar panel heating systems are oriented towards preparing hot water for hygienic purposes. Not many installations are prepared for space heating since the efficiency of the solar system is not sufficient during winter. Increasing area of solar collectors causes the need of more intensive heat dissipation for summer period. This can be realized by several techniques.

One of the ways to deal with this problem is to store extra solar energy in the ground and as a result to regenerate the lower source, which energy is used as a cold reservoir for heat pump. Artificial ground regeneration can solve this problem. This solution is known and proposed already for many years [15] and nowadays the advantages of heat storage and lower heat source regeneration are even more interesting [16] [17].

III. MATERIALS AND METHODS

In this paper we propose the cooperation of two most popular, sources of heat. By smart connection of solar collectors and a heat pump it is possible to extend applicability of both sources.

Proposed system is presented in Fig. 1. Increasing the number of solar collectors will ensure higher heat capacity hot tap water in the spring and autumn. In summer, solar collectors will provide accelerated regeneration of the lower heat source of the heat pump. The benefits of using solar collectors are as follows. It is an renewable and environment friendly source of heat, does not require frequent maintenance and small amount of electric energy supply to the circulation pump is needed. Additional disadvantage is the dependence on weather conditions. During winter the efficiency of solar collectors is not sufficient, so heat pump becomes the main source of heat.

Reliable and efficient cooperation of both heat sources can only be achieved through appropriate control that will be

provided by a dedicated controller. The analysis and prediction of outdoor parameters based on weather stations can contribute to significant savings thanks to flexibility of the system.

A. System configuration

Proposed installation, shown in Fig. 1, consists of two main heat sources i.e. ground source heat pump and solar collectors and is open to connection of additional conventional sources like boiler or electric heater. Heat sources are connected through combined storage tank, which contains hot water storage for both heating and domestic hot water in one container. Such a connection enables the use the solar energy for both purposes. Installation is also equipped with photovoltaic cell. Their main purpose is to provide electrical energy for pumps in case of lack of electricity from public grid during blackout. In that case it will not allow overheating of the installation.

Most of system components will be used in the form of commercially available products with the exception of heat pump, which will be built as dedicated for the system. Heat pump (HP) is connected to the lower heat source in the form of ground heat exchanger. Horizontal heat exchanger is preferred due to lower investment cost, but requires larger area of terrain with comparison to a vertical borehole probe. If the ground area is not sufficient, borehole heat exchanger can be installed. Heat from the lower heat source is carried by low-freezing liquid to the evaporator of the heat pump. Liquid temperature and working parameters of the heat pump are monitored by the HP Controller. This one is connected to the Master Controller and switches the heat pump on when there is a demand for heating the water in storage tank. HP Controller switches the heat pump off when set temperature in the storage tank is achieved or due to any alarm. The ground heat exchanger is used by the heat pump as the lower heat source during winter and any time when there is a demand for water heating. During summer the heat exchanger is used for regeneration of the ground thermal energy storage with the heat gained by solar collectors.

B. System controller

The main innovation of the system is the controller and the control algorithm, which through the appropriate management of heat sources reduces the cost of use. The process of selecting individual system components starts with the system calculator, which is available to the company having the described solution. With the help of this tool, the system manufacturer can configure the heating system depending on the needs of the residential building, including the number of inhabitants, building size, wall thickness, window area and presence etc. Calculation of energy consumption of given building is necessary for proper selection of individual system components. In the calculator mentioned above, the priority will be the use of renewable energy sources - see Fig.2.

Basic parameters determining the final configuration of the system are given in a simple way. The surface area of the plot is entered by the client. In the case of small available garden



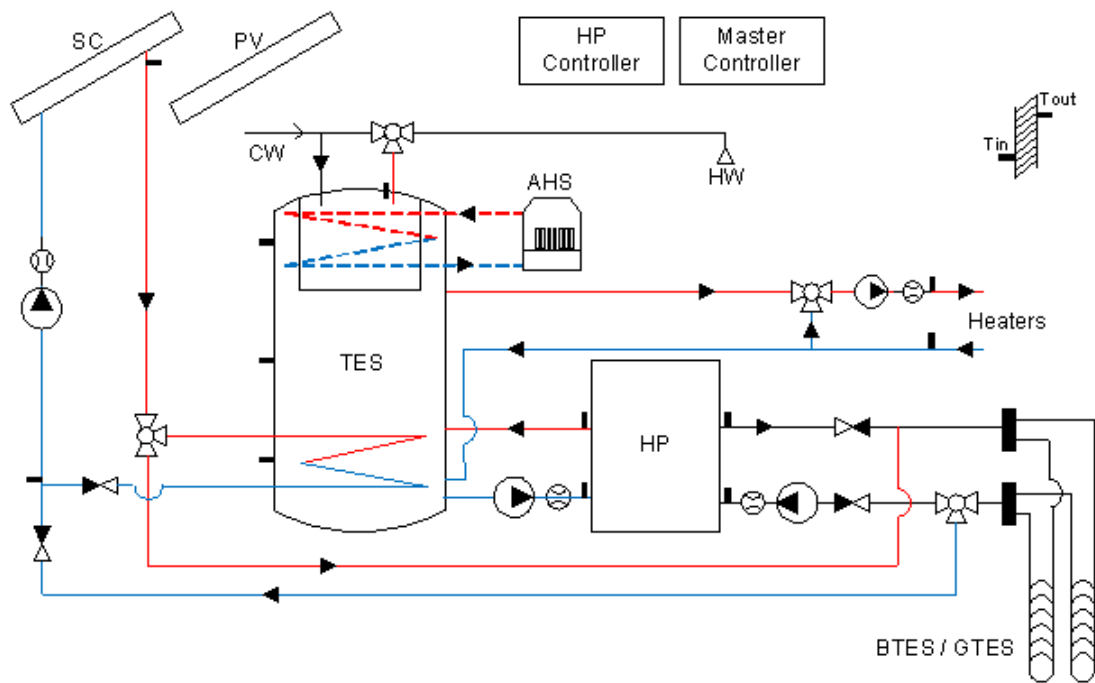

Fig. 1. Layout diagram of the domestic heating system based on the solar collectors and ground heat pump: SC solar collector, HP ground heat pump, AHS additional heat source, PV photo-voltaic cell, TES thermal energy storage tank, BTES/GTES borehole/ground thermal energy storage, CW cold water, HW hot water

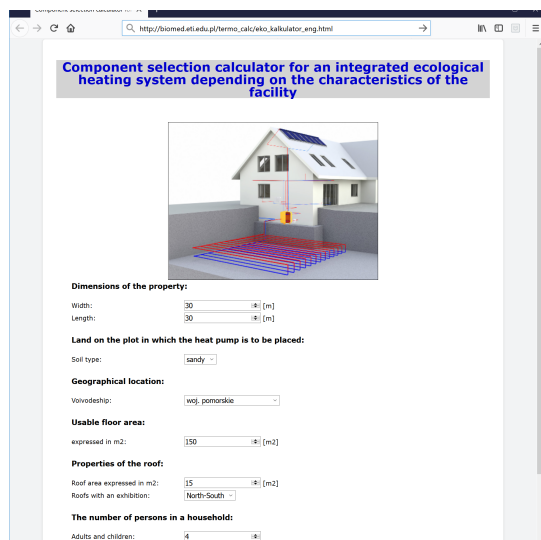

Fig. 2. The configurator of selecting system components

area, the system suggests a heat pump with borehole ground heat exchanger. Another parameter is the type of available soil. This parameter allows to determine the density of pipes in the ground heat exchanger. Data regarding the location of the building and the available roof surface determine the size and quantity of the suggested solar collectors. Building localization allows to download publicly available data on the number of sunny days a year. Then, data on the number of inhabitants is entered in order to determine the estimated demand for

hot water. The last data relates to user-preferred sources of heat. On this basis, all calculations are made. In addition, the calculator will estimate the level of investor's annual savings compared to a conventional heating system.

All default settings of the configurator can be changed so that the investor matches the elements to his needs. These parameters on the one hand define the household's demand for energy, and on the other hand, they determine the possibility of acquiring energy from environmentally friendly technologies.

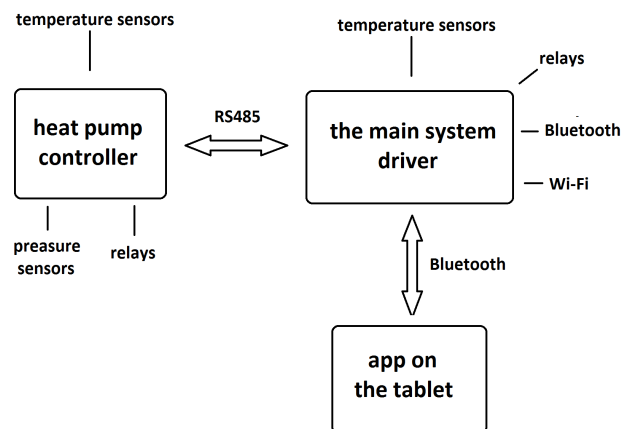

Fig. 3. The operating scheme of the heating system controller

Depending on the selection of individual system components, the main system controller is configured by indicating

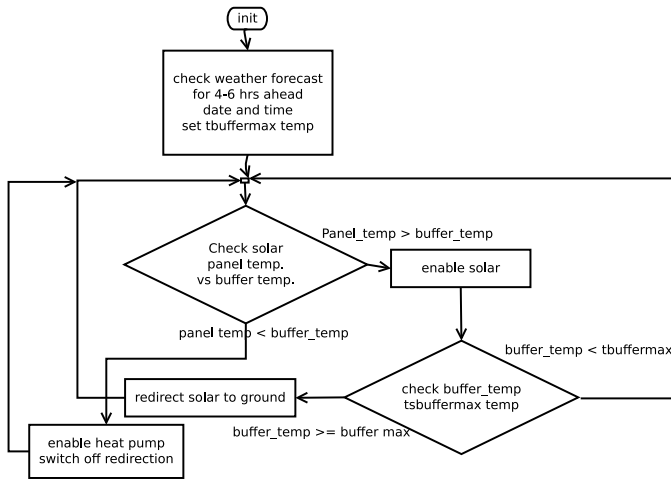

Fig. 4. Simplified control loop selecting power sources for heating

which sources are available in a given configuration. On this basis, the algorithm checks which heat source is the most energy-efficient at any given time. On this basis, it selects the currently operating heat source. An overview diagram of communication between electronic circuits is shown in the Fig. 3.

The whole system will be managed by means of the distributed embedded system. Authors have decided to create distributed system, where separate unit will control the heat pump. It will be supervised by means of master controller (MC). The MC will run main control algorithm. Proposed algorithm checks status of each available energy source. The sources are ranked by their environmental properties and are selected in such manner the green energy must be utilized first. The solar conditions are estimated on the base of the solar panel temperature but also the PV panel power. The decision is also supported by clock and calendar, where sunrise and sunsets hours are available. Decision can be supported by the external weather forecast eg. if temperature outside is expected to drop significantly, both sources can be engaged to accumulate more energy. If solar energy is insufficient then it has to be supported by the heat pump capacity. And if the heat pump is not sufficient with lack of solar energy - an additional heat source can be engaged, upon request. Gas or oil boiler, chimney or electrical heaters can be engaged. This decision will be consulted with the end user individually.

The PV panel is utilized to deliver power for the pumps in solar system. During the summer, when solar energy exceeds user demand, it's excess will be directed towards ground exchanger in order to protect solar installation from overheating and additionally accumulate energy in the ground for winter period.

A simplified version of proposed control algorithm is shown in Fig.4. The main controller will also inform end user about current level of heating costs and pollution caused by the system. Additionally remote interface utilizing Internet is considered. It will allow remote monitoring of the system

performance and control the thermal comfort externally - e.g. by means of the smartphone. Depending on the final agreement data from such system can be accessible to manufacturer. It should allow future modifications and tuning.

IV. RESULTS

In the case of the described system, the process of collecting measurement data takes time. Heating systems are characterized by their period of use during the year [13]. Also, the nature and intensity of their operation strongly depends on the atmospheric conditions and average temperature in the heating season. Well-tested energy gains for various types of heating system control should take several heating cycles. Then the data should be averaged. This task will be performed successively.

As part of the work results, a simulation of changes in the load of individual heat sources is presented. The operation of solar panel will depend on the day length. In Fig. 5 day/night ratio calculated on the base of sunrise and sunset times is shown. In Fig. 6 calculated efficiency of solar panel as a function of solar position is shown. Data are calculated for Gdansk(Poland) region with fixed position of the solar panel (angle of 30° and direction to the south is assumed).

In Fig. 7 main idea of the system is visualized. For given installation (building) normalized monthly energy demand is depicted by the continuous line. The maximal demand for heating energy is during winter months such as December, January, February. Lowest energy demand is in summertime, when energy is utilized form preparing hot water for hygienic purposes.

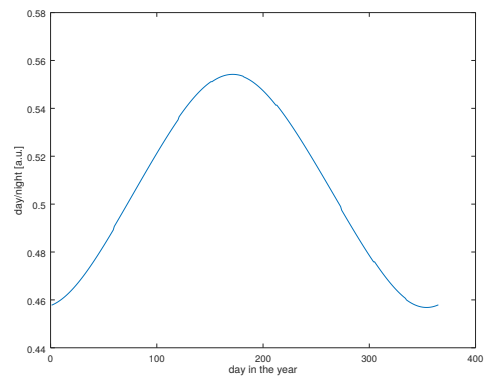

Fig. 5. The calculated day/night ratio over year

Dash-dotted line represents energy production by the solar collectors matched in "traditional" way. Dashed line represents oversized solar collectors area. Here is an example of 5 times oversize (5 times larger area). One can notice extended period of solar energy usage (gray bars below the chart) and grey marked area represents overproduction of the solar energy. In case of proposed system this can be utilized to regenerate heat-pump's lower source. The oversize factor depends on the soil heat absorption, which in general is not known yet and is installation dependent. Authors propose measurement of soil properties and calculation of final oversizing factor in site by



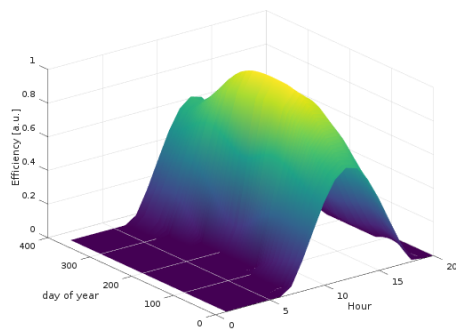

Fig. 6. Calculated efficiency factor for solar panels

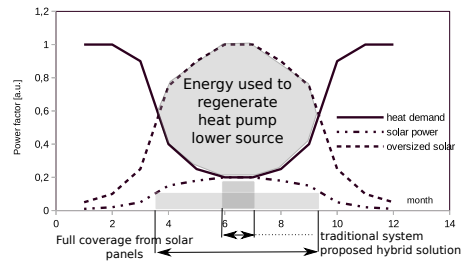

Fig. 7. The operating scheme of the heating system controller - artificially generated data, solar panels oversized 5 times

installation of solar panels in such way, that their area can be easily extended.

V. CONCLUSION

The presented thermal comfort management system for a single-family house or an office can be a solution for problems related to environmental pollution for the moderate climate zone. The most important role is played by the fact that the solar collectors are oversized in combination with the appropriate control, allowing to satisfy the thermal needs in the periods of spring and autumn. It is worth mentioning once again that such a solution is possible only when it is possible to collect excess heat from solar collectors in the summer. This solution can be a good alternative to heating swimming pools.

Hybrid combination of heat pump, solar collectors and emergency PV cells is an excellent solution for building heating by saving primary energy resources and environmental protection with reducing carbon footprint. Additionally the mean time between failures was increased too due to independent power supply obtained from PV panels and reduced risk of solar panel overheating and leakage.

Smart application that can be connected with the applications such as Calendar enables thermal comfort planning. By additional information about actual heat source utilization user is aware of ecology and pending costs.

Installation of the solar collectors should take in consideration both, azimuth and direction of the collector's plane. It is possible to optimize alignment of the collector for given location.

Smart control of the whole system is essential for optimal energy re-distribution in the installation.

The controller monitors the external conditions and switches between RES seamlessly. It is also used to configure system for maximum efficiency and to save our valuable fuel resources and money that could be spent better elsewhere. No more, no less [18].

REFERENCES

- [1] Anil Markandya, Deger Saygin, Asami Miketa, Dolf Gielen, and Nicholas Wagner. The true cost of fossil fuels saving on the externalities of air pollution and climate change.
- [2] Edited by Jovan Mitrovic. *Heat Exchangers - Basics Design Applications*. InTech, 2012.
- [3] G. Kopp and J. L. Lean. A new, lower value of total solar irradiance: Evidence and climate significance. *grl*, 38:L01706, January 2011.
- [4] Tadeusz Rodziewicz, Janusz Teneta, Aleksander Zaremba, and Maria Waclawek. Analysis of solar energy resources in southern poland for photovoltaic applications. *ECOL CHEM ENG S.*, 20(1):177–198, 2012.
- [5] Olczak P., Kryzia D., Augustyn A., and Olek M. The economic profitability of the changing size of solar collectors surface in the case study of the household domestic hot water installation (in polish). *The Bulletin of The Mineral and Energy Economy Research Institute of the Polish Academy of Sciences*, 102:7790, 2018.
- [6] Olek M., Olczak P., and Kryzia D. The sizes of flat plate and evacuated tube collectors with heat pipe area as a function of the share of solar system in the heat demand. *E3S Web of Conferences* 10.
- [7] Milad Mohsenzadeh and Reza Hosseini. A photovoltaic/thermal system with a combination of a booster diffuse reflector and vacuum tube for generation of electricity and hot water production. *Renewable Energy*, 78:245 – 252, 2015.
- [8] Jochen Bundschuh and Guangnan Chen. *Sustainable Energy Solutions in Agriculture*. CRC Press.
- [9] J. Perko, V. Dugec, D. Topic, D. Sljivac, and Z. Kovac. Calculation and design of the heat pumps. In *Proceedings of the 2011 3rd International Youth Conference on Energetics (IYCE)*, pages 1–7, July 2011.
- [10] David Fischer and Hatem Madani. "on heat pumps in smart grids: A review". *Renewable and Sustainable Energy Reviews*, 2017.
- [11] Richard B. Simms, Simon R. Haslam, and James R. Craig. Impact of soil heterogeneity on the functioning of horizontal ground heat exchangers. *Geothermics*, 50:35 – 43, 2014.
- [12] W.H Leong, V.R Tarnawski, and A Aittomki. Effect of soil type and moisture content on ground heat pump performance: Effet du type et de l'humidit du sol sur la performance des pompes chaleur capteurs enterrs. *International Journal of Refrigeration*, 21(8):595 – 606, 1998.
- [13] Krzysztof Kupiec, Barbara Larwa, and Monika Gwadera. Heat transfer in horizontal ground heat exchangers. *Applied Thermal Engineering*, 75:270 – 276, 2015.
- [14] Yan Gao, Rui Fan, HaiShan Li, Ran Liu, XinXing Lin, HaiBao Guo, and YuTing Gao. Thermal performance improvement of a horizontal ground-coupled heat exchanger by rainwater harvest. *Energy and Buildings*, 110:302 – 313, 2016.
- [15] Penrod E. B. and Prasanna K.V. Design of a flat-plate collector for a solar earth heat pump. *Solar Energy*, 6(1):922, 1962.
- [16] Sliwa T. and Rosen M.A. Natural and artificial methods for regeneration of heat resources for borehole heat exchangers to enhance the sustainability of underground thermal storages: A review. *Sustainability*, 7:13104–13125, 2015.
- [17] Androulakis N.D., Armen K.G., Bozis D.A., and Papakostas K.T. Simulation of the thermal performance of a hybrid solar-assisted ground-source heat pump system in a school building. *International Journal of Sustainable Energy*, 37(4):311–324, 2018.
- [18] T.D. Eastop and D.R.Croft. *Energy Efficiency for engineers and Technologists*. Longman Scientific & Technical, Willey and Sons, NewYork, 1990.