

Smart MV/LV distribution transformer for Smart Grid with active prosumer participation

Author

Marek Adamowicz

Keywords

Smart Grid, distribution transformer, power electronics

Abstract

With the development of distribution networks and their gradual transformation into intelligent Smart Grid type networks the relevance and share of controlled power converter systems used as interfaces between energy sources and the grid, and between grid and the recipients, will grow. This paper elaborates on the concept of replacing conventional 50 Hz distribution transformers with intelligent distribution transformers. A solution of a three-stage smart distribution transformer of modular design is proposed, oriented to connecting prosumers as active recipients of electricity with enhanced requirements, and owners of small renewable energy systems (RES). Two active stages: AC-DC on the MV side and DC-AC on the LV side provide the ability to compensate reactive power and shape voltage parameters. The simulation results presented here confirm that the smart transformer's intermediate stage, through the use of isolated DC-DC converters with high-speed semiconductor devices, provides the ability to quickly adjust the power flow between the primary and secondary sides.

1. Introduction

In the coming years distribution grids will be subject to upgrades to improve power supply's reliability and efficiency, and to allow greater consumer involvement in its generation and more effective use. One of the most important European Union policy objectives for 2020 in this respect is to convert the existing distribution grids to Smart Grids [1, 2] that integrate the behaviours and actions of all users connected to them. Among the long-term challenges associated with the objective, the following deserve particular mention: local energy management, full integration of Smart Grids with distributed generation sources, integration with RES and central power plants, and intensification of the distributed generation connected close to end users. The need to deploy new technologies in distribution grids is related not only with the progressive increase in the number and powers of connected RES units, but also with the expected gradual increase in the number of electric car charging stations. In the latter case, particular attention should be paid to proposals of multi-vehicle quick charging stations, which due to their high power inputs might be connected to medium voltage (MV) grids.

With new legislative solutions supporting the RES development, it can be expected that more and more energy consumers will decide to adopt a proactive attitude of prosumers generating electricity in small domestic plants. Also expected is an increased number of RES systems integrated with intelligent buildings.

Distribution grid development strategies, such as those

implemented in the U.S. [3] and Germany [4], assume that in addition to the participation in power generation, prosumers will actively participate in the management of peak load in the system, making available electricity storage in their electric vehicles as part of the so-called vehicle-to-grid (V2G) infrastructure. In Denmark the V2G infrastructure development is closely related to further development of wind power, as exemplified by the E.D.I.S.O.N. pilot project implemented on the island of Bornholm [5, 6]. The E.D.I.S.O.N. project is meant to demonstrate in a separate 10 kV grid supplied from RES the feasibility of smooth interaction of the energy and transport sectors, in the framework of V2G infrastructure with the maximum total peak load of 25 MW. Work towards the transformation of distribution grids in Smart Grid are already in progress also in Poland, e.g. in the Pomeranian region [7].

In Smart Grids, RES and V2G systems can be new elements of the voltage and reactive power control systems, which requires changes in the technologies of the existing power equipment. With the Smart Grids development the relevance and share of controlled power converter systems used as interfaces between energy sources and the grid, and between grid and the recipients, will grow. High-tech power electronic devices must be used, among other applications, in electric vehicle fast charging stations and in intelligent buildings. This relates to many new challenges for power electronic equipment manufacturers [8]. Among the concepts of using modern power electronic systems

in Smart Grid mentioned in the literature, the concept of replacing conventional 50 Hz distribution transformers with smart distribution transformers deserves special attention [9]. Smart MV/LV distribution transformers are characterised by a compact three-stage design, including:

- input stage in the form of controlled power electronic AC-DC converter on the MV side,
- intermediate stage in the form of DC-DC converter with isolation implemented at high frequency in the range of 20 kHz... 50 kHz
- output stage in the form of controlled power electronic DC-AC converter on the LV side.

A smart distribution transformer of modular design consists of a voltage-specific number of serially connected basic low-voltage functional modules called Power Electronics Building Blocks [10], which can be built of commercially available high-speed semiconductor power devices: transistors and diodes with blocking voltages 1.2 kV or 1.7 kV. A generic diagram of the AC-DC/DC-AC power electronics building block with galvanic isolation of the primary and secondary sides, which enables bi-directional energy flow and voltage adjustment, is shown in fig. 1.

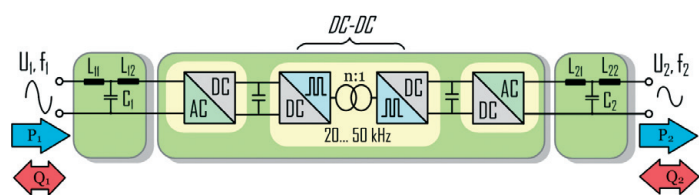

Fig. 1. AC-DC/DC-AC power electronics building block for the application in series per phase on the MV side, and in parallel per phase on the LV side

Another smart transformer design consists in single-phase AC-DC/DC power electronics building block in series on the MV and in parallel on the LV side, that jointly provide a DC circuit on the LV side. Then energy on the LV side is converted by one or more parallel three-phase DC-AC systems with appropriate input power and circuitry. In fig. 2 a concept is shown of a three-stage smart distribution transformer design, made up of a series of single-phase AC-DC/DC modules, and a three-phase four-wire DC-AC inverter on the LV side.

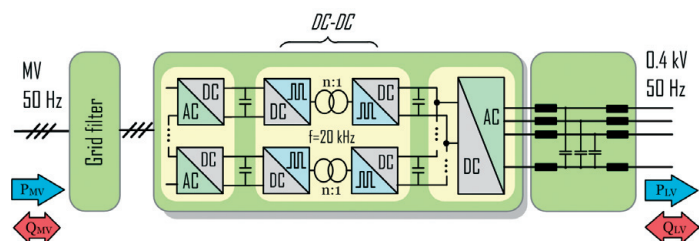

Fig. 2. Concept of three-stage design of smart distribution transformer with modular structure of AC-DC and DC-DC stages and a three-phase DC-AC inverter on the LV side

Active stages: AC-DC on the MV side and DC-AC on the LV side provide the ability to compensate reactive power and shape voltage parameters. Due to its controlled converter systems, a smart distribution transformer can thus be used as the basic actuator in the process of active and reactive power control in distributed generation systems, offering new properties and features [11-15], unprecedented in conventional MV/LV distribution transformers, such as:

- smooth control of supply voltage parameters
- capacity of reactive power compensation
- smooth control of power flow
- balancing of connected systems
- increased resistance to the presence of harmonics in power grid
- capacity of self-regulation in the case of power inflow from connected distributed generation sources.

In addition, with a buffer battery as built-in energy storage, a smart distribution transformer can be directly used, for instance, in fast EV charging systems connected to a MV grid [16], enabling seamless management of demand for power at the point of charging.

Operating frequency of the semiconductor devices in a smart transformer's different AC-DC and DC-AC stages in the order of kHz or tens of kHz allows reducing the size and cost of the passive sinusoidal filters required on the MV and LV sides. Raising the operating frequency of the DC-DC intermediate stage transistors and diodes allows, in turn, significant reduction in the size of the transformer magnetic circuits used in the smart transformer design, compared with the sizes of conventional 50 Hz transformers. Off the shelf availability of semiconductor devices with blocking voltages 1.2 kV or 1.7 kV, including silicon carbide (SiC) high-speed anti-parallel diodes [10], allows reducing the switching losses in individual modules, and achieving a satisfactory smart distribution transformer performance.

It should be noted that fast transistors and diodes, including those of new semiconductor material silicon carbide, for higher blocking voltages in the range of 10 kV [17] and frequencies of tens of kHz, are currently at the development stage of laboratory prototypes. It can be expected that their further development by 2020 will enable designing power electronic devices for an MV grid in a similar way as power electronic converters are now designed for LV grids.

Different topologies of basic functional modules can be found in the literature, as well as different concepts of combining them in the systems of smart MV/LV distribution transformers [9-18]. From a technical point of view, the deployment of smart distribution transformers using currently available high-speed diodes and transistors in MV grids of lowered voltage (3 to 4 kV) is justified, especially in separated pilot systems with RES, MV drives with energy recuperations or vehicle charging stations. The spectrum of processes resulting from changes in the distribution transformer technology, as well as the expected benefits, are so broad that in the coming years they should be verified in separate systems with known parameters, allowing unambiguous assessment of aspects such as reliability, functionality and efficiency. An example may be the pilot system with a smart

3.3 kV/0.41 kV 300 kVA distribution transformer [18] implemented by ABB and Areva at the University of Nottingham as part of the UNIFLEX project.

With the concept of combining functional modules in the structure of a smart transformer, as shown in fig. 2, to the voltage reduced to 3 to 4 kV corresponds the number of three cascaded LV converter modules per phase, which at this stage allows evaluating the device functionality, control dynamics, and suitability for the grid operator with a view to distribution grid code requirements. Only a positive evaluation of the functionality and usability of selected smart transformer topologies in separated lowered voltage grids will substantiate the deployment of full-size devices in 15 kV distribution grids.

2. Smart 3.3 kV/0.4 kV distribution transformer model

Fig. 3 presents a diagram of a model of a three-phase smart 3.3 kV/0.4 kV distribution transformer with 180 kVA rated power and three-stage modular design. The AC-DC input stage on the MV side is a three-phase seven-tier voltage inverter with modular design, which in each phase consists of three connected 20 kVA bridge inverters (H-bridge transistors). Each bridge inverter can generate a three-tier AC voltage component on the MV side. During the smart distribution transformer's operation, the capacitors in DC intermediate circuits of each input stage bridge inverter are charged to the same voltage, in accordance with a specific control algorithm.

AC-DC bridge converters in each module are connected with DC-DC DAB – Dual Active Bridge, providing two-way flow of energy. The number of high frequency transformers of the three-phase n-tier converter made up of cascade interconnected H bridges may be determined by relation $(3(n-1)/2)$. Secondary sides of all DC-DC converters are connected in parallel to form a common

intermediate DC circuit on the low voltage side. Owing to the 1.5:1 pulse transformer voltage ratios, the blocking voltages of the semiconductor devices used in the DC-DC converters on the LV side may be smaller than on the MV side. Basic parameters of the smart distribution transformer model shown in fig. 3 are presented in tab. 1.

The LV output stage of the smart distribution transformer shown in fig. 3, consists of two three-phase four-leg 90 kVA grid converters. The output stage enables the power supply of end-users and prosumers involved in power generation, three-phase and single-phase alike. Compared to the three-leg inverter with split DC capacitor also providing four-wire power supply, the four-leg inverter delivers twice the voltage between phase and neutral of the three-leg inverter, providing better capabilities of neutral conductor current compensation. The use of two DC-AC inverters connected in parallel on the one hand allows obtaining the required power using commercially available highly efficient 1200 V, 225 A IGBT transistor modules, and on the other hand provides redundancy in the case of failure of one of the inverters. By using the LCL output filter and predictive control methods known from the literature [19], the smart transformer's DC-AC output stage is able to ensure high quality AC voltage parameters. As shown in fig. 3, both the output stage's three-phase four-leg DC-AC inverters can use a common LCL filter [20].

Currently applied methods of three-phase four-leg DC-AC inverter control [19] can ensure flexibility of users' power supply and the ability to generate asymmetrical voltages in individual phases, which, among other benefits, allows for:

- symmetrisation of DC-AC output stage currents
- correction of voltage asymmetry on the LV side
- control of AC voltage positive component without asymmetry correction

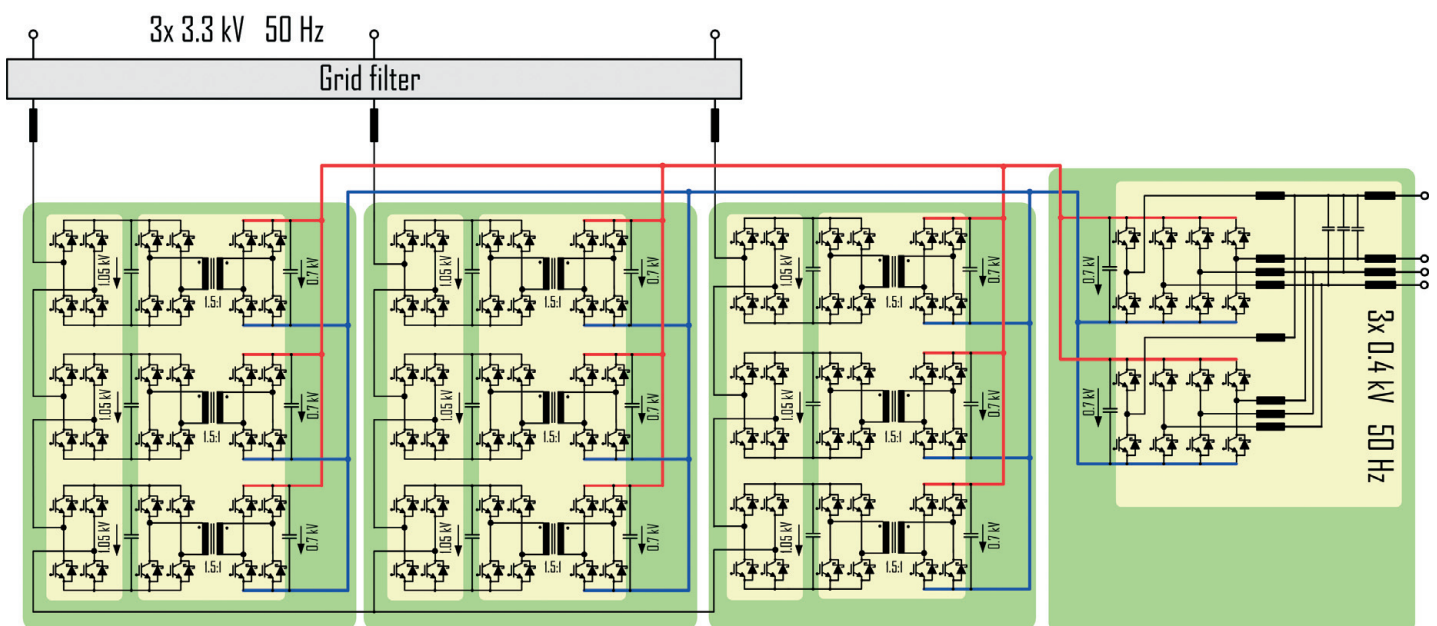

Fig. 3. Diagram of smart 3.3 kV/0.4 kV distribution transformer with three-stage design and 1.5:1 voltage ratio

Number N of modules per phase	Number of MV voltage levels	Power of a single MV module	DC voltage of a single MV module	AC voltage of a single MV module	Blocking voltage and transistor current* on AC MV side	DC voltage of a single LV module	Blocking voltage and DC-DC converter transistor current* on LV side
3	7	20 kVA	1.05 kV	635 V	1.7 kV; 100 A	0.7 kV	1.2 kV; 100 A

* at model overload capacity assumed at 130%

- elimination of AC voltage negative component resulting from voltage dip.

Modern three-phase four-leg DC-AC grid inverters are able to flexibly cope with most problems of voltage and current asymmetry. The properties of four-leg inverters have not so far been fully used in distributed generation and RES systems in the way in which this can be achieved in a smart distribution transformer.

3. Analysis of high frequency isolated DC-DC converter

DC-DC converter with two converter bridges and a high-frequency transformer (dual active bridge) is the key element of a smart distribution transformer, providing galvanic isolation and enabling voltage transformation and bi-directional power flow control. One of the benefits of using high-frequency for voltage transformation is the ability to significantly reduce the transformer's overall dimensions due to the use of modern magnetic materials for its construction, such as amorphous or nanocrystalline cores with adequately high magnetic induction.

Related with the use of modern magnetic cores is an increase in the transistor switching frequencies; in a smart transformer isolation stage it shifts the burden of its design towards accomplishment of the smallest possible switching losses in the DC-DC converter's semiconductor devices. Commercially available silicon carbide (SiC) semiconductor diodes with blocking voltages 1.2 kV and 1.7 kV are characterized by a many times smaller transition charge at switching than ultrafast silicon diodes. Their use and the use of modern methods of so-called ZVS – zero voltage switching allows for isolated DC-DC converter efficiencies above 95%.

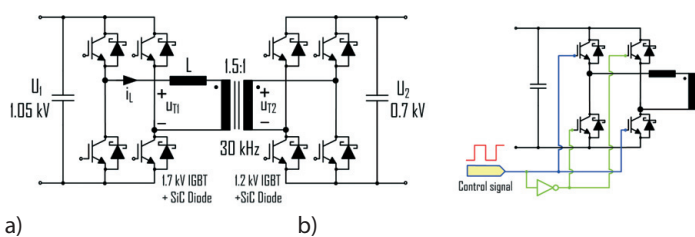

Fig. 4. Dual active bridge DC-DC converter with IGBT transistors and silicon carbide (SiC) anti-parallel diodes (a); separation of IGBT transistors control signal (b)

A diagram of a dual active bridge DC-DC converter with 1.7 kV IGBT transistors on the MV side and 1.2 kV IGBT transistors on the LV side is shown in fig. 4

The task of the two converter bridges of the DC-DC converter (fig. 4a) is the voltage modulation on both sides of the high-frequency transformer. The method of full-bridge isolated DC-DC converter control consists in shifting in time the rectangular control signals relative to each other (fig. 4b) with the bridge converters transistors on the transformer's primary and secondary sides. In the simplest control method, to a certain extent sufficient to control the power transmitted between the converter bridges, both control signals have the same duty cycle $D = 0.5$. The transmitted power P is adjusted by controlling the phase angle ϕ between the control signal on the primary side and the signal of primary side bridge transistors control, according to the following formula:

$$P = \frac{U_1 \cdot (U_2 / n) \cdot \phi \cdot (\pi - \phi)}{2 \cdot \pi^2 \cdot f_s \cdot L} \tag{1}$$

where: U_1, U_2 – voltages on the DC side of the primary and secondary sides' bridges, L – serially connected inductance for energy storage and reduction of the steepness of current changes in the transformer circuit, and f – switching frequency of the converter's transistors. Fig. 5 shows results of the analysed converter's simulation, using the method of shifting rectangular control signals with duty cycle $d = 0.5$.

The power transmitted between the converter's bridges is non-linearly dependent on the phase shift ϕ between the control

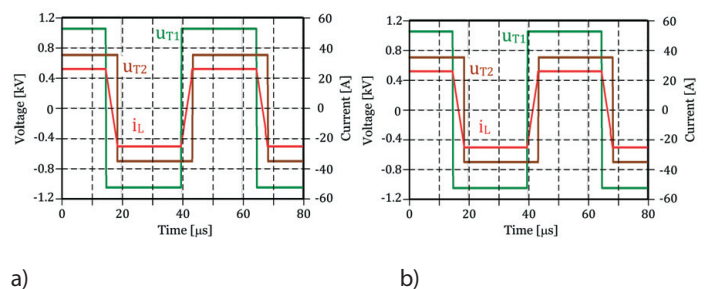

Fig. 5. Simulation waveforms of voltages u_{T1}, u_{T2} and primary current i_L at $U_1 = 1.05$ kV, $U_2 = 0.7$ kV and power $P = 20$ kW for case (a): $f_s = 30$ kHz, $L = 100$ μ H and case (b): $f_s = 20$ kHz, $L = 150$ μ H, in open system for the same phase shift $\phi \approx \frac{\pi}{6}$

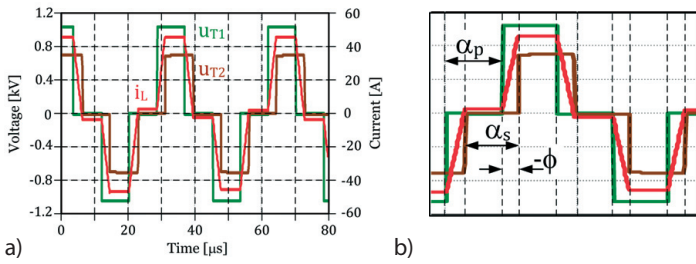

Fig. 6. Simulation waveforms of voltages u_{T1} , u_{T2} and primary current i_L at $U_1 = 1.05$ kV, $U_2 = 0.7$ kV, power $P = 20$ kW, $f_s = 30$ kHz and serial inductance $L = 50$ μ H (a); phase angle ϕ and angles α_p , α_s of primary and secondary side control signal modulation

signals. For large ϕ values, any further change in the phase angle causes a small change in the DC-DC converter's active power output, while it significantly increases the power internally exchanged between DC capacitors of the primary and secondary sides in the transformer and inductor L , circuit, thus increasing the i_L current amplitude. The maximum transmitted power is limited by inductance L and frequency f of the transistor switching. The control step, i.e. the minimum phase angle change in the digital control system, depends on the control processor clock frequency and the step of control program execution. The power control rate depends on the actual phase angle ϕ . The bidirectional power flow can be high-rate controlled at low loads. More advanced isolated DC-DC converter control methods allow

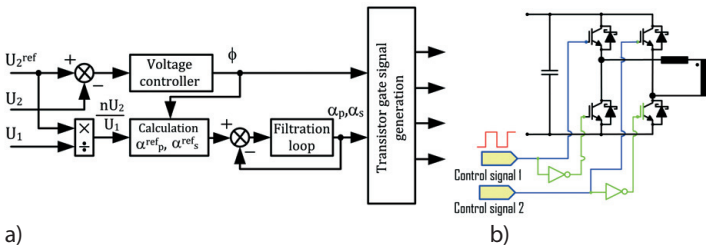

Fig. 7. Control system of dual active bridge DC-DC converter with dual pulse width modulation [21] (a), separation of primary side bridge control signals (b)

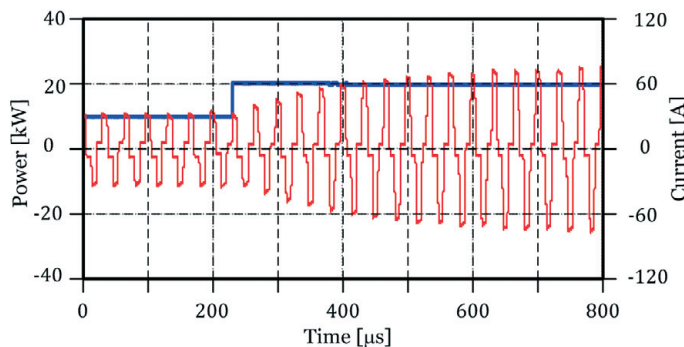

Fig. 8. Transitional state after DC-DC converter power change from 10 kW to 20 kW: secondary transformer current and converter power output waveforms

power flow regulation, zero-voltage transistor switching (ZVS) over a wide range, and the operation at lower serial inductance L in the transformer circuit by using – in addition to shifting the control signals relative to each other – also independent adjustment of duty cycles D_1 and D_2 of the signals controlling both the DC-DC converter's bridges. [21]. Simulation waveforms using the method of dual modulation of control signal pulse width (*Dual PWM*) are shown in fig. 6.

Four modes of control of dual active bridge DC-DC converter with double control signal modulation can be distinguished [21]. Modulation angles α_p of the primary side control signal, and α_s of the secondary side control signal, may be equal or independently set. For the control mode, the waveforms of which are shown in fig. 6, occurs [21]:

$$\frac{|\alpha_p - \alpha_s|}{2} < \phi < \min\left(\frac{\alpha_p + \alpha_s}{2}, \pi - \frac{\alpha_p + \alpha_s}{2}\right) \quad (2)$$

A control system of dual active bridge DC-DC converter with dual modulation of control signal pulse width is shown in fig. 7.

Fig. 8 presents simulation results of the transition state of the transformer's secondary current after a step change in DC-DC converter power from 10 kW to 20 kW using dual modulation control.

As can be seen in fig. 8, at serial inductance $L = 50$ μ H, the transition state at load change from 50% to the rated power lasts approximately 300 μ s. The transformer's secondary current amplitude at rated load 75 A results from the transformer ratio 1.5:1.

4. Summary

The three-stage smart distribution transformer solution with modular design presented in this paper is oriented to connecting prosumers as active recipients of electricity with enhanced requirements, and owners of small RES systems and distributed generation sources, providing the possibility of plug & play connection, known so far in computer technology. The smart transformer's intermediate stage, through the use of isolated DC-DC converters with high-speed semiconductor devices, provides the ability to quickly adjust the power flow between the primary and secondary sides.

Under the research grant "Smart MV/LV distribution transformer for Smart Grid with active prosumer participation", conducted by the author at Gdańsk University of Technology in the Department of Mechatronics and High Voltage Engineering, and funded by ENERGA SA Group, theoretical analysis, simulation studies, and laboratory tests of a model of the AC-DC/DC-AC converter module, which is the basic functional unit of the proposed smart distribution transformer of a new generation, are currently in progress. In addition, within the project, methods of communication between the modules, and between the master control system and user interface will be developed.

REFERENCES

1. Jiyuan F., Borlase S., The evolution of distribution, *IEEE Power and Energy Magazine* 2009, Vol. 7, No. 2, pp. 63–68.
2. Ipakchi A., Albuyeh F., Grid of the future. *IEEE Power and Energy Magazine* 2009, Vol. 7, No. 2, pp. 52–62.
3. California Utility Vision And Roadmap For The Smart Grid Of 2020, EPRI Electric Power Research Institute, Final project report, [on-line]: <http://www.energy.ca.gov/2011publications/CEC-500-2011-034/CEC-500-2011-034.pdf>.
4. The German Roadmap. E-Energy / Smart Grid. German Commission for Electrical, Electronic & Information Technologies of DIN and VDE.
5. EDISON Project Report, [on-line]: [http://www.edison-net.dk/Dissemination/ Reports.aspx](http://www.edison-net.dk/Dissemination/Reports.aspx).
6. Xu Z. i in., Towards a Danish Power System with 50% Wind – Smart Grids Activities in Denmark, Proc. IEEE Power & Energy Society General Meeting, 2009, pp. 1–8.
7. Czyżewski R., Babś A., Madajewski K., Smart Grids – selected objectives and directions of distribution system operator actions, *Acta Energetica* 2012, Issue 8, pp. 31–35.
8. Adamowicz M. i in., Sterowanie rozdziałem energii w układach przekształtnikowych pojazdów elektrycznych i źródeł odnawialnych, *Przegląd Elektrotechniczny (Electrical Review)* 2012, Issue 4b, pp. 7–12.
9. Wang J., Huang A. Q., Sung W., Liu Y., Baliga B. J., Smart Grid Technologies. *IEEE Industrial Electronics Magazine*, June 2009, pp. 16–23.
10. Adamowicz M., Krzemiński Z., Strzelecki R., Hybrid High-frequency-SiC and Line-frequency-Si based PEBB for MV Modular Power Converters, Proc. IEEE Conf. on Industrial Electronics IECON2012, Montreal, 2012, pp. 1–6.
11. Wang D. et al., Theory and application of a distribution electronic power transformer, *Electric Power System Research* 2009, Vol. 77, pp. 219–226.
12. Akagi H., Kitada R., Control and Design of a Modular Multilevel Cascade BTB System Using Bidirectional Isolated DC/DC Converters, *IEEE Transactions On Power Electronics* 2009, Vol. 26, No. 9, pp. 2457–2464.
13. Fan H., Li H., A High-Frequency Medium-Voltage DC-DC Converter for Future Electric Energy Delivery and Management Systems, Proc. 8th IEEE Conf. on Power Electronics – ECCE Asia, 2011, pp. 1031–1038.
14. Research on Voltage and Power Balance Control for Cascaded Modular Solid-State Transformer, *IEEE Transactions On Power Electronics* 2011, Vol. 26, No. 4, pp. 1154–1166.
15. Lu X. et al., Talk to Transformers: An Empirical Study of Device Communications for the FREEDM System, Proc. IEEE Smart Grid Communications (SmartGridComm), 2011, pp. 303–308.
16. Hõimoja H., Vasiladiotis M., Rufer A., Power interfaces and storage selection for an ultrafast EV charging station, Proc. IEEE Conf. on Power Electronics, Machines and Drives, University of Bristol, UK, 27–29 March 2012.
17. Das M. K. i in., 10 kV, 120 A SiC Half H-Bridge Power MOSFET Modules Suitable for High Frequency, Medium Voltage Applications, Proc. IEEE Energy Conversion Congress and Exposition ECCE, 2011, pp. 2689–2692.
18. UNIFLEX PM, Advanced Power Convertors for Universal and Flexible Power Management in Future Electricity Networks, [on-line]: <http://www.eee.nott.ac.uk/uniflex/Project.htm>.
19. Rodriguez J. i in., Predictive Current Control of a Three-Phase Four-Leg Inverter, Proc. 14th IEEE Power Electronics and Motion Control Conference (EPE/PEMC), 2010, pp. 106–110.
20. Wojciechowski D., High Power Grid Interfacing AC-DC PWM Converters with Power Conditioning Capabilities, Proc. IEEE Conf. on Industrial Electronics IECON2012, Montreal, 2012, pp. 1–6.
21. Jain A. K., Ayyanar R., PWM Control of Dual Active Bridge: Comprehensive Analysis and Experimental Verification, *IEEE Transactions On Power Electronics* 2011, Vol. 26, No. 4, pp. 1215–1227.

Publication of post-contest

The paper was awarded first prize in ENERGA SA's competition for a research grant.

Marek Adamowicz

Gdańsk University of Technology

e-mail: madamowi@ely.pg.gda.pl

An assistant professor in the Department of Mechatronics and High Voltage Engineering of Gdańsk University of Technology. Former manager of the LIDER project on AC/AC converters made up of silicon carbide semiconductor devices for wind turbines in the first program for the development of young researchers of the National Centre for Research and Development (2010–2012). His scientific interests include: development of new converter systems for MV distribution grids, control methods of wind turbines and MV electric drives with bidirectional power flows.