

# Strength assessment of a version of joint of sandwich panels

Ryszard Pyszko, M.Sc., Eng.  
Gdańsk University of Technology



*In this elaboration are presented proposals of strength assessment procedure of a joint of two equal-depth sandwich panels so connected in the same plane that the joint line is parallel to stiffeners of the panels. The joint is subjected to lateral and tension loads.*

**Keywords :** sandwich panel, ultimate load-carrying capacity, panel joint

## ABSTRACT

## INTRODUCTION

Searching for novel structural solutions in order to cope with „murderous” pressure of economical factors – so clearly observed in aircraft industry – has not pass over maritime transport. Since in the classical solutions of ship structures continually perfected for centuries not much can be improved one of the ways of the searching for structural improvements is to apply unified structural elements.

Development of laser-welding techniques made its industrial applications possible – and this way – also production of steel sandwich panels being double-skin structures mutually connected by a system of closely spaced stiffeners joined with the plating just by using laser-welding technique. Any introduction of a novel solution into ship hull structure, especially for primary strength members, is associated with the necessity to demonstrate that many requirements, especially concerning structural safety, are satisfied. Some of the structural requirements deal with strength of structural connections among which are also panel-to-panel joints.

## GEOMETRY OF THE ANALYZED JOINT

In the joint in question load is transferred by two external, symmetrical cover plates. The design of the joint together with its geometrical characteristics is shown in Fig.1. The same breadth was assumed for both the cover plates connecting upper and lower plating, respectively. The distance between the panels was so selected as to maintain the spacing between stiffeners of the panels, constant. In the analyzed problem such values of cross-section parameters are searched for at which the joint obtains its maximum load-carrying capacity at :

- ★ a suitable breadth of cover-plate, **dn** - which is associated with its location relative to panel stiffeners (**du** in Fig.1)
- ★ a suitable thickness of cover-plate, **gn** - which is associated with the fillet weld leg (**asp** in Fig.1)

And it is assumed that : the load-carrying capacity of the joint constitutes the possibility of transferring an assumed load by a given structure (joint – connected panels) under condition that neither a loss of structural stability nor extensive plastic deformations of the structure in any its cross-section, occurs. The capacity is related to the assumed value of the stresses,  $\sigma_{red} = f(\text{load})$ , resulting from the applied load.

Description of the geometrical parameters and their denotations (as in Fig.1) are given in Tab.1. Every quantity marked “1” through “15” constitutes the searched variable parameter.

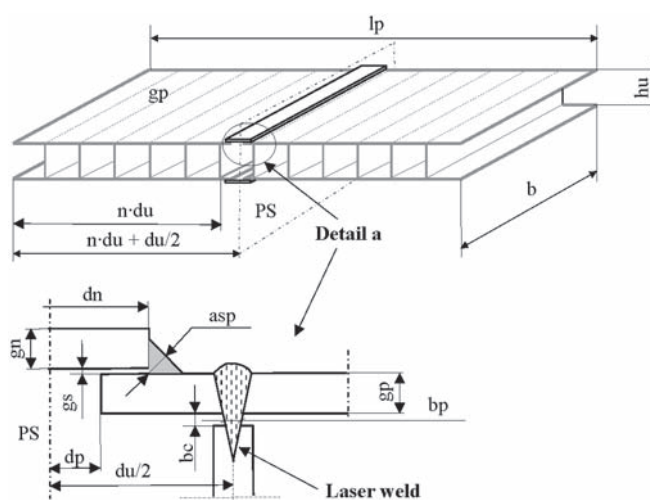

Fig. 1. Geometrical characteristics of the analyzed joint .

Tab. 1. Geometrical parameters of the joined panels .

1. <b>gp</b> – plating thickness	9. <b>b</b> – specimen width
2. <b>hu</b> – stiffener depth	10. <b>h</b> – total depth of panel
3. <b>gu</b> – stiffener thickness	11. <b>n</b> – number of stiffeners in one panel
4. <b>du</b> – spacing of stiffeners	12. <b>asp</b> – fillet weld leg
5. <b>gn</b> – cover-plate thickness	13. <b>bp</b> – weld penetration width
6. <b>dn</b> – cover-plate width	14. <b>gs</b> – gap thickness
7. <b>bc</b> – gap height	15. <b>dp</b> – panel’s end overlap
8. <b>lp</b> – specimen length	<b>PS</b> – laser’s plane of symmetry

## PROBLEM ANALYSIS

The analysis is aimed at investigation of the behaviour of the considered joint of panels under lateral and tension loading.

### Panel fastening and loading

For the panels in question the following assumptions were taken :

- ⊛ The panel is freely supported at its ends, where one of which is slidable
- ⊛ The load applied to the panel is composed of two sets of forces :  $F_x$  – axial tension forces, and  $F_z$  – lateral forces producing constant bending moment in the region of cover-plate connection – Fig.2. The forces  $F_x$  and  $F_z$  act simultaneously, increase uniformly and independently to each other. The resulting load is a combination of the

forces increasing from zero- value up to that at which the limit load- carrying capacity of the investigated joint is exceeded

- ⊛ Stress distribution at the supports and in the regions of application of forces is of no significance from the point of view of the assumed aim
- ⊛ Geometrical arrangement of the panel together with the cover-plates is symmetrical relative to the plane PS
- ⊛ The load acts symmetrically relative to the plane PS.

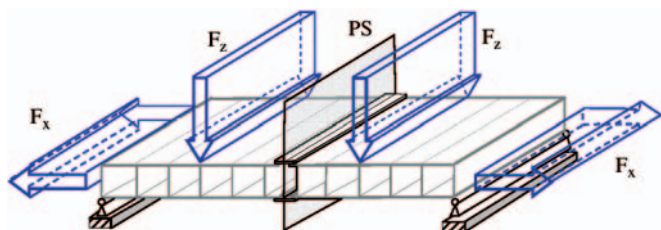

Fig. 2. Loading scheme of PP01 panel.  $F_z$  – pair of the lateral forces producing the constant bending moment  $M_g$  in the region of cover-plate connection  $F_x$  – tensile forces applied to the panel.

### Structural model for FEM calculations

For the above described joint a structural model for calculations by means of Finite Element Method (FEM) was elaborated. With a view of symmetry of the problem as well as the assumed loading mode, some simplifications were introduced as follows :

- simplification of joint geometry (appropriate modeling)
- introduction of appropriate boundary conditions (symmetry)
- application of loads by setting-up appropriate displacements in model mesh nodes.

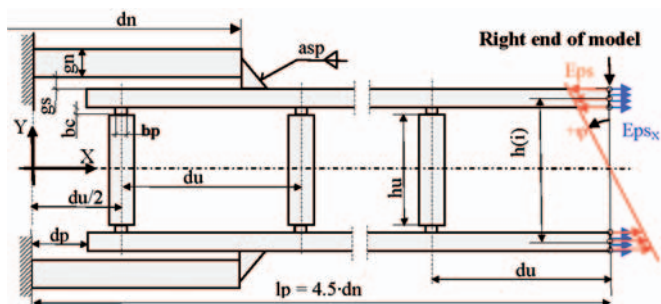

Fig. 3. Geometry of the joint's model for FEM calculations.  $M_g \sim \varphi \sim Eps_\varphi$  – bending moment loading – relevant displacements  $\rightarrow$   
 $F_x \sim Eps_x$  – tension force loading – relevant displacements  $\rightarrow$   
 $h(i)$  – distance between mesh nodes. Remaining notations - see Fig.1 .

The loading onto the joint is realized by applying relevant displacements to the right-hand end of the model, Fig.3, at FEM mesh nodes. The displacements act in one plane and the same directions. Load resultants of the upper and lower plating result from superposition of the displacements  $Eps_x$  and those due to the twisting angle  $\varphi$ , Fig.3.

$$\begin{aligned} Eps(i) &= Eps_x(i) + Eps_\varphi(i) = \\ &= Eps_x(i) + \frac{h(i)}{2} \text{tg}(\varphi) \end{aligned} \quad (1)$$

It was assumed that the displacements along Y – axis, due to the twisting angle, are negligibly small (because of its small values ranging from 0° to 1.2°). Under the above mentioned assumptions the displacement (load) resultants are as follows, Fig.4.

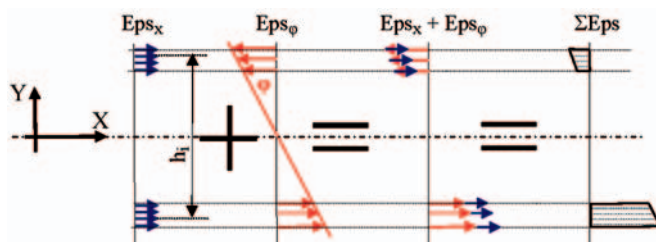

Fig. 4. Load applied to the right-hand end of the model .

In order to find the searched variables the analyzed joint's model was parametrized. The number of the geometrical parameters of the joint was reduced by assuming values of selected parameters constant. The dimensions which can be calculated on the basis of the values of the parameters, were also omitted. The result of the simplifications is presented in Tab.2 ; after the reduction only three searched variables have been left.

Tab. 2. Specification of geometrical parameters describing PP01 joint after simplifications [1]

Geometrical parameters of the panels to be joined :	Parameters of the panels to be joined, after simplifications :
1. gp – plating thickness = 2.5 mm	
2. hu – stiffener depth = 40 mm	
3. gu – stiffener thickness = 4 mm	
4. du – stiffener spacing = 120 mm	
5. gn – cover-plate thickness	5. gn – cover-plate thickness
6. dn – cover-plate length	6. dn – cover-plate length
7. bc – gap height = 0.2 mm	
8. lp – specimen length = 4.5 du	
9. b – specimen width = 1 mm	
10. h – total depth of the panel = hu + 2(gp+bc)	
11. n – number of stiffeners in one panel = 4 pcs	
12. asp – fillet weld leg	12. asp – fillet weld leg
13. bp – weld penetration width = 1 mm	
14. gs – gap thickness = 0.5 mm	
15. dp – panel's end overlap = 10 mm	

To the assumed model were used the assumptions resulting from a modeling method of sharp notches, which consisted in introducing the under-cuts of suitable values of radiuses, Fig.6.

Also, it was assumed that during load increasing the elements are able to enter in contact. In Fig.6. are indicated the places where the distance between neighbouring pairs of nodes are continuously monitored. After performing the calculations it appeared that – at the initial geometry (for all the considered cases) and the applied mode of model's loading – such contact occurred in a few points only until the model has reached its limit load-carrying capacity - Ngr.

In a limited number of cases such contact occurs in the region 1. The first phase of the sliding contact in the stiffener occurs because of a relatively long distance from the region 1 to the plating support. The instant of the contact is denoted :  $Kr\_posz = nr$ , i.e the number of the step after which the contact will appear. This is illustrated in Fig.5.

A contact in the regions 2 and 3 occurs practically in the phase when the joint itself suffers a damage, i.e. beyond the range where Ngr is determined.

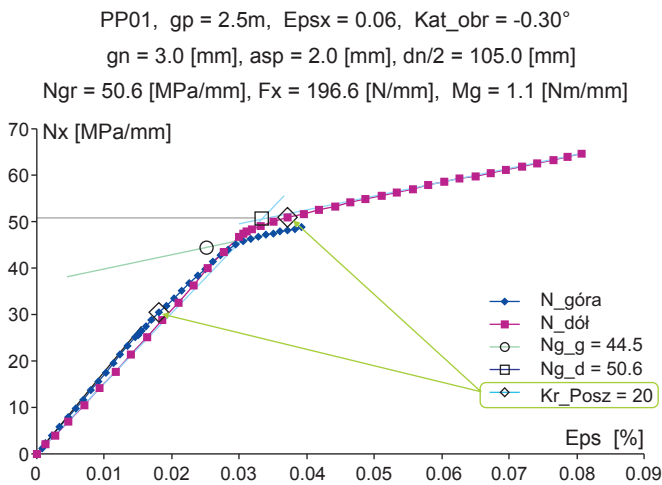

Fig. 5. The diagram of the relation  $N_x = f(Eps)$  with marked loading steps and the contact in the region 1, shown in Fig.6.

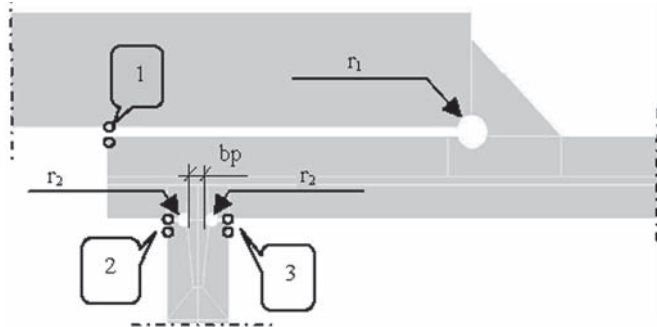

Fig. 6. The detail of FEM model in the region of the cover-plate / panel connection. Fillet weld connection between cover-plate and plating,  $r_1 = 0.8$  mm. Connections between plating and stiffener,  $r_2 = 0.4$  mm. Width of weld penetration :  $bp \approx 1$  mm. Contact regions : 1, 2, 3. Notation of a pair nodes :  $\circ$ .

For the problem in question the linear elastic stress-strain characteristics of material with strain hardening was assumed, Fig.7.

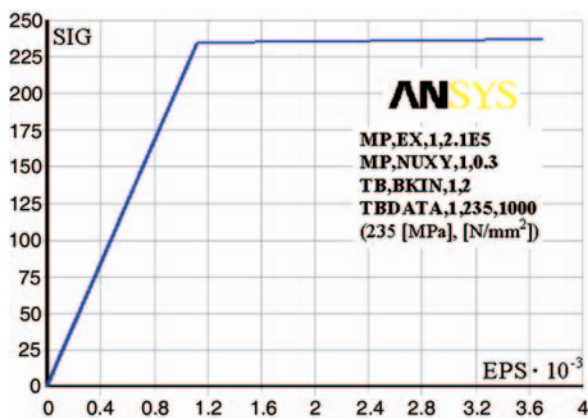

Fig. 7. Stress – strain characteristics of material for plating, stiffeners and welds.

For modeling the structure, the following FEM elements taken from the file of ANSYS software, were used (Fig.8.) :

- ⊕ ET,1,plane42 – for panel, cover-plates and welds
- ⊕ ET,2,LINK1 – for contacting element – to maintain constant distance between the ends of panel plates, Fig.7.

**Boundary conditions, Fig.8.**

Because of the geometrical symmetry (Fig.2 and 3) and the mode of load application by means of displacements, Fig.4, the following boundary conditions were used :

```
LSEL,S,LINE,,96
LSEL,a,LINE,,416
Nsl,S,1
D,all,ux,0 ! locked displacements along X- axis
! free displacements along Y- axis
Lsel,all
Nsel,all
Displacements (loading)
```

The displacements are set-up depending on the distance along Y-axis; along X-axis they are applied to the nodes at the right-hand end of the panel, see Fig.3 and 4.

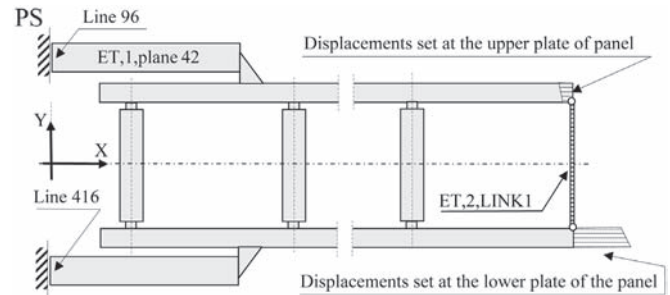

Fig. 8. Model of connections between panel elements, for FEM calculations.

**Calculations – response of the structure**

For the above described geometry, boundary conditions and loading, the calculations were conducted in the range of non-linear material characteristics. The distribution and quantity of reaction forces appearing in the nodes with set displacements, were considered as the response of the structure in question. Next, some simplifications dealing with conversion of the results to their final form, were applied - Fig.9.

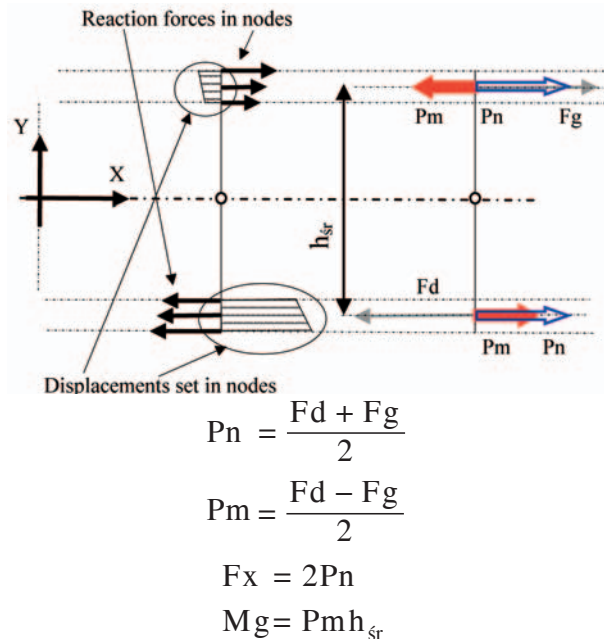

Fig. 9. Determination of the force and bending moment loading the panel.  $P_m$  – pair of forces giving constant bending moment proportional to  $Eps_\phi$ ,  $P_n$  – forces causing tension of the panel, proportional to  $Eps_x$ ,  $F_g, F_d$  – resultant response forces in upper and lower plating, respectively.

**Simplification 1** – it was assumed that – due to relatively small thickness of plating as compared with the panel depth – the resultant force in the upper plating,  $F_g$ , and the lower plating,  $F_d$ , can be taken equal to the respective sums of reaction forces in the nodes. The forces mainly act along X-axis, as their components along Y-axis are negligibly small (Fig.9).

**Simplification 2** – it was assumed that the resultant vector of the forces  $F_g$  and  $F_d$  is situated in the middle of the plating thickness  $g_p$  (Fig.9).

**Simplification 3** – it was assumed that at the above given distribution of forces the obtained reaction forces can be converted into the panel loading forces and next into the constant bending moment proportional to  $\phi$  and the tension force proportional to  $E\epsilon_{sx}$  – Fig.4.

**Analysis of results**

Series of example calculations were performed for the single joint of the PP01 panel of constant geometry and various cover-plate parameters, (Tab.2); the range of variability of the parameters is given in Fig.11. In Fig.10 are shown changes of values of the stresses  $N_x$  in the cross-section where displacements within the panel have been set up, as well as the way of determination of  $N_{gr}$  for the joint in question. In the further part of the analysis the use of  $N_{gr}$  has been deemed more comfortable.

**Eps** – set-up, uniformly increasing load in Eq (1)

**$N_x$**  – stresses along X- axis (response of the structure)

**$N_{góra}$**  – stresses in the upper plating at the right-hand end of the panel, after averaging the reaction forces  $F_g$  (Simplification 2)

**$N_{dół}$**  – stresses in the lower plating at the right-hand end of the panel, after averaging the reaction forces  $F_d$  (Simplification 2).

**Method of tangents** – consists in finding the line tangent to the tension curve at its origin S1- Fig.10 as well as that tangent to the tension curve at its end S2- Fig.10 The intersection point of the tangent lines determines a value of limit stresses for the curve, i.e. those for the cross-section where loads (displacements) have been set up [2].

**$N_{g_g}$**  – value of limit stresses determined for the upper plating– acc. the method of tangents

**$N_{g_d}$**  – value of limit stresses determined for the lower plating– acc. the method of tangents.

Lp. 5,  $g_p = 2.5m$ ,  $E\epsilon_{sx} = 0.06$ ,  $Kat_{obr} = -0.30^\circ$ ,  **$N_{gr} = 49.7$**

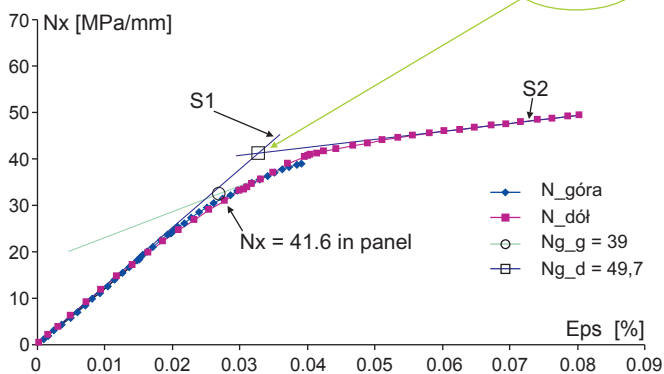

Fig. 10. The diagram of the relation  $N_x=f(E\epsilon_s)$  in the cross-section where the displacements were set at the right-hand end of the panel.

**$N_{gr}$**  – limit load-carrying capacity of the panel, determined by the greater value out of  $N_{g_g}$  and  $N_{g_d}$ . An exceedance of the loads which generate stresses equal to  $N_{g_g}$  (Fig. 10.) does not cause the load-carrying capacity of the panel to be exhausted. Only when  $N_{g_d}$  is reached the load-carrying capacity of the panel is exhausted due to occurrence of plastic deformations in a cross-section, or loss of structural stability, or – alternatively – due to occurrence of both the phenomena simultaneously.

**$g/d$  [krok]** – in this column is given the calculation step in which  $N_x=41.6$  [MPa/mm] Fig. 10 i.e.  $N_{gr} > N_x$ . At the so

determined limit load-carrying capacity, stresses in the panel will be always at the safe side. Moreover, some margin of the capacity, resulting from the difference :  $N_{gr} - N_x$ , is still left.

**$F_x_g$**  – stands for the reaction force in the upper plating in  $g/d$  [krok] step.

**$F_x_d$**  – stands for the reaction force in the lower plating in  $g/d$  [krok] step.

**$F_x$  [N/mm]** – stands for the loading force applied to the panel, Fig.9.

**$M_g$  [Nm/mm]** – stands for the loading moment applied to the panel, Fig.9.

**SUMMARY AND CONCLUSIONS**

The common conclusions for the selected series of the investigations of  $N_{gr} = f(dn, g_n, asp)$  are presented in Fig.11.

- In the case when the values of the cover-plate thickness  $g_n$  are close to that of plating,  $g_p$ , the load-carrying capacity of the joint of the panels maintains nearly on the same level. The fillet weld leg  $asp$  is associated with the cover-plate thickness, Series I, Fig. 11
- The cover-plate length decisively improves the joint's capacity when  $dn > du$ , otherwise it does not show any influence, Fig. 11
- The range of optimum values of the cover-plate length is located outside the first stiffener, within the distance from  $1/4 du$  to  $1/3 du$
- In the cases where values of the cover-plate thickness  $g_n$  are significantly greater than that of the plating thickness  $g_p$ , the joint's capacity increases. This is additionally dependent on the cover-plate length  $dn$  – Series II and III, Fig.11
- The distance  $dp$  should tend to  $dp = du - 1/2gu$ , Fig.3
- Because of the limitations of the applied method it was not possible to indicate either a location or cause of exhausting the panel's load carrying capacity. With the use of the applied procedure it is possible to determine  $N_{gr}$ , i.e. the instant when an exhaust of the panel's load-carrying capacity may be expected.

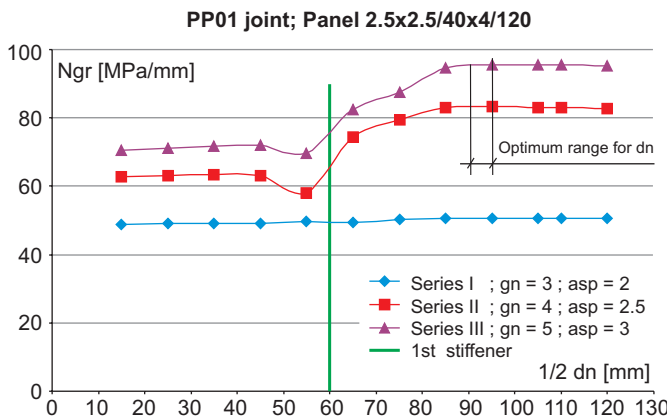

Fig. 11. The diagram of the relation  $N_{gr} = f(dn, g_n, asp)$ .

**BIBLIOGRAPHY**

1. R. Pyszko : *Proposal of a catalogue of joint units of the panels whose stiffeners are to be connected, and the analysis of their manufacturing feasibility* (in Polish). EUREKA: ASPIS E13074 Project, Research report No. 170/E/05. Faculty of Ocean Engineering and Ship Technology, Gdańsk University of Technology
2. Jeom Kee Paik, Anil Kumar Thayamballi : *Ultimate Limit State Design of Steel-Plated Structures*. Jon Wiley & Sons. ISBN 0-471-48632-9.

