

The analysis of hydrodynamic forces and shape of towrope for an underwater vehicle

Jan Bielański,
Gdansk University of Technology

Abstract

The paper presents a method of calculating forces in an underwater vehicle towrope as well as its shape under the influence of hydrodynamic forces induced by water flowing round the towrope and vehicle. The rope hydrodynamic loads are calculated from the Morison's equation and the vehicle forces and moments by means of coefficients. An example of calculations for a vehicle has been performed in the Matlab system for one towing speed.

Keywords: underwater vehicle, towrope, calculating forces

INTRODUCTION

Ropes and their sets used in the ocean engineering require calculations of shapes and loads. They are characterized by a significant sag, different than in the land applications. The traditional applications in the maritime economy are fishing industry and sea ports. Discoveries of the energy resources under the sea bottom and the inexhaustible quantities of rare metals on the ocean bed have increased the use of ropes in the exploration and production of raw materials.

The main cause of the intensity of forces generated on the sea ropes is considerable difference between the density of water and air. The product of density and motion velocity of those media is equal, respectively:

- for sea water and sea current of a 1-3 m/s velocity $\rightarrow \rho v \in \{1000, 3000\} [N/(m^3s)]$;
- for air of 10-50 m/s velocities $\rightarrow \rho v \in \{10, 60\} [N/(m^3s)]$.

Taking into account that the hydro- and aero-dynamic forces depend on the second power of medium flow velocity and that the diameter of sea ropes is an order of magnitude greater, it appears that the ratio of forces generated on an average sea rope to those generated on a land rope is in the range $\{25e3-70e3\}$. So, the generated loads and forces transmitted by the sea ropes are up to 5 orders of magnitude greater than those transmitted by the land ropes.

The paper concentrates on the towropes of underwater exploration vehicles and similar underwater vehicles, self-propelled and with external supply. In the former, a frequent and significant problem is design of proper diving rudders needed to overcome the forces induced by the flow on the vehicle and on the towrope. Those forces often present also a considerable problem for the vehicle operator. For self-propelled vehicles, the towed set of a safety rope and a control-supply cable may become an even greater problem when the vehicle encounters a sea current of a significant velocity. The induced forces may then be much greater than the thrust forces generated by the vehicle propellers, which threatens the vehicle integrity and safety. The calculations were performed for a vehicle towed with one speed and the best conditions were determined of free towing without a need of using diving rudders (except for balancing the weight and buoyancy forces), which allows a stable motion of the vehicle with the least possible resistance of towing at a given depth.

Analysis of the impact of environment on the underwater vehicle and towrope.

An underwater vehicle equipped with the bow and stern diving rudders and the direction rudder as in Fig.1, is hooked at point B to the towrope, connecting it with the ship. The vehicle, towrope and ship move in the Oxz vertical plane. It is assumed that the vehicle does not turn around the stern-bow longitudinal axis (Gx1 axis), but it turns, by an angle g , around the transverse axis (Gy1) going through the centre of gravity and parallel to the Oy axis. This assumption is fulfilled when the two bow diving rudders and/or the two stern rudders are laid on the same angle. During the diving stage, the operator by laying the diving rudders on the angles, respectively: α_H - bow rudders and α_{ST} - stern rudders, turns the vehicle by an angle γ and then, operating the diving rudders, keeps that diving angle until the required depth is reached. Then the vehicle is levelled ($\gamma=0$). A symmetry of rudder profiles is assumed as well as a linear characteristic of the lift coefficients within the applied angle of incidence range and also a quadratic relation of the resistance force coefficients.

The force generated on the vehicle and its rudders has a horizontal resistance component and vertical lift component generated on the hull and rudders and also vertical gravity and vehicle buoyancy forces, designations given in Fig. 2. Equations of all the component forces and moments are the following:

$$\begin{aligned} R_{x0} &= q_0 * (-C_{DS}(V_S, \gamma) * S_W - C_D(\alpha_H) * S_{pH} - C_D(\alpha_{ST}) * S_{pST}) \\ R_{z0} &= -(\rho_0 - \rho_w) * g * V_0 + q_0 * (-C_{LS}(V_S, \gamma) * S_W - C_L(\alpha_H) * S_{pH} - C_L(\alpha_{ST}) * S_{pST}) \\ M_{Gy} &= -R_L * L / 2 * \sin(\beta_0 - \gamma) + C_{MS}(V_S, \gamma) * q_0 * S_W - I_H * q_0 * C_L(\alpha_H) * S_{pH} + I_{ST} * q_0 * C_L(\alpha_{ST}) * S_{pST} \end{aligned} \quad (1)$$

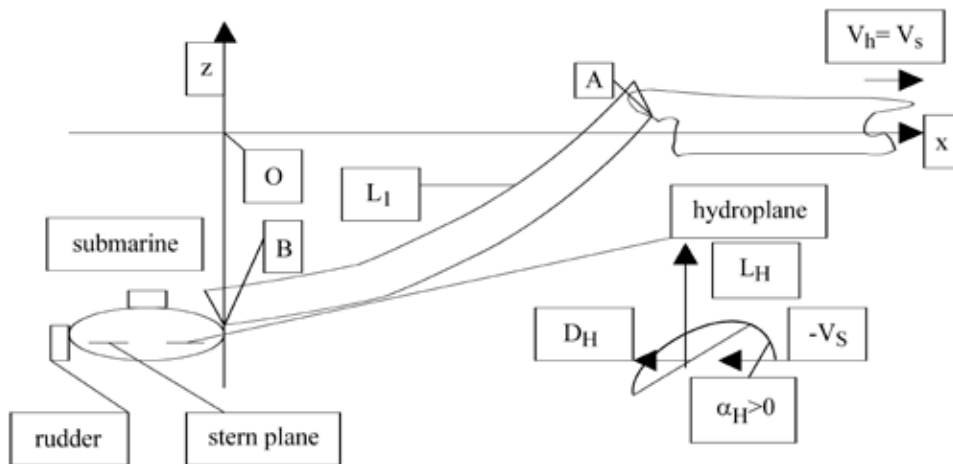

Fig. 1 Coordinate system Oxyz for the ship and the rope with underwater vehicle.

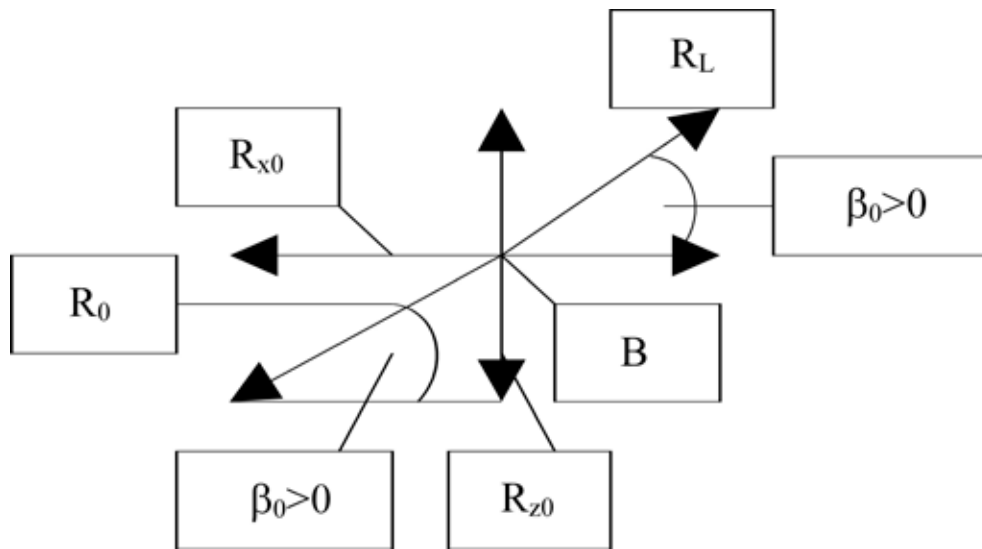

Fig. 2 The horizontal and vertical components of the hydrodynamic force impact on the underwater vehicle.

Position of the vehicle centre of gravity, point G, is assumed in its geometric centre and this value ($L/2$ in formula (1) for the MGymoment) should be changed when the position changes. This is shown in Fig. 3.

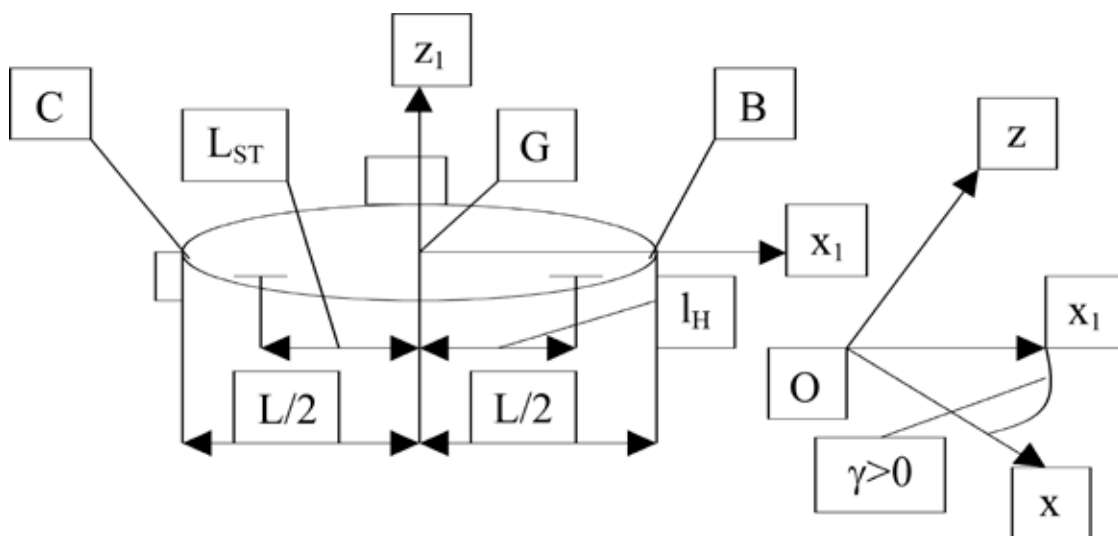

Fig.3 Coordinate system Gx1z1 for the underwater vehicle.

In the case of small angles of incidence for planes and the underwater vehicle, the lift coefficients may be described as a linear function of the angle of incidence and the resistance coefficients as a quadratic function. Expressions for plane are the following:

$$\begin{aligned} C_L(\alpha) &= k_L \cdot \alpha \\ C_D(\alpha) &= k_0 + k_D \cdot \alpha^2 \end{aligned} \quad (2)$$

Expressions for the vehicle assume the form:

$$\begin{aligned} C_{LS}(V_S, \gamma) &= k_{LS}(V_S) * \gamma \\ C_{DS}(V_S, \gamma) &= k_{0S}(V_S) + k_{DS}(V_S) * \gamma^2 \\ C_{MS}(V_S, \gamma) &= -k_{MS}(V_S) * \gamma \end{aligned} \quad (3)$$

After substitution of equations (2) and (3) to the set of equations (1), the formulae describing the force components and trimming moment have the form:

$$\begin{aligned} R_{x0}/q_0 &= -S_w * (k_{0S} + k_{DS} * \gamma^2) - k_0 * (S_{pH} + S_{pST}) - k_D * (S_{pH} * \alpha_H^2 + S_{pST} * \alpha_{ST}^2) \\ R_{z0}/q_0 &= -(\rho_0 - \rho_w) * V_0 * g / q_0 + S_w * k_{LS} * \gamma + k_L * (S_{pH} * \alpha_H + S_{pST} * \alpha_{ST}) \\ M_{Gy}/q_0 &= -R_L * L / 2 * \sin(\beta_0 - \gamma) / q_0 - S_w * k_{MS} * \gamma - k_L * (I_H * S_{pH} * \alpha_H - I_{ST} * S_{pST} * \alpha_{ST}) \end{aligned} \quad (4)$$

where:

$$\begin{aligned} RL &= R_0 = (R_{x0}^2 + R_{z0}^2)^{1/2}, \\ \beta_0 &= \arctg(R_{z0} / R_{x0}). \end{aligned}$$

Outside the vehicle submerging and emerging phase, equations (4) get simplified. The vehicle moves in the horizontal position and if the towrope and is also horizontal, then the pull force in the rope has only the horizontal component. Then the vehicle trim angle $\gamma=0$ and with zero trimming moment generated on the vehicle the angle of incidence of the bow and stern diving rudders will be equal if their distance from the centre of gravity is equal ($I_H=I_{ST}$) and the plane area is identical ($S_{pH}=S_{pST}$), i.e. then $\alpha_H = \alpha_{ST}$. Equations (4) will have a simplified form:

$$\begin{aligned} R_{x0}/q_0 &= -S_w * k_{0S} - 2 * k_0 * S_{pH} - 2 * k_D * S_{pH} * \alpha_H^2 \\ R_{z0}/q_0 &= -(\rho_0 - \rho_w) * V_0 * g / q_0 + 2 * k_L * S_{pH} * \alpha_H \\ M_{Gy}/q_0 &= 0 \end{aligned} \quad (5)$$

As in such case of balanced motion the vertical component of the force acting on the vehicle must be zero, from the second equation of the equation set (5) we may obtain an expression for such a value of the diving rudder angle of incidence that the corresponding lift force will balance the difference of weight and buoyancy forces. The expression will be as follows:

$$\alpha_H = \frac{(\rho_0 - \rho_w) * V_0 * g}{2 * q_0 * k_L * S_{pH}} \quad (6)$$

The resistance of a towed underwater vehicle is given by the equation:

$$R_{x0} = -q_0 * k_{0S} * S_w + 2 * q_0 * k_0 * S_{pH} + \frac{k_D * S_{pH}}{2 * q_0} * \left\{ \frac{(\rho_0 - \rho_w) * V_0 * g}{k_L * S_{pH}} \right\}^2 \quad (7)$$

Then, after an analysis of forces and moments generated on the underwater vehicle surface, the forces acting on the vehicle towrope are described. The expressions here below determine the shape and the internal forces in the rope connecting the underwater vehicle with a sea surface ship. The following boundary conditions of the assembly are known: $z(A)$ - height of the rope fixture at point A on the ship (see Fig. 1) and $z(B)$ - submergence depth of point B where the rope is secured to the vehicle. It is also possible to measure the total tension force in the rope at fixture point A. The assumed rectilinear motion of the vehicle places the rope in the ZOx plane. The state of static equilibrium of the vehicle and rope is sought, neglecting the loads from the wave motion of water particles and the rope elastic strain. The state of static equilibrium is determined by the following actions:

- weight of the rope and underwater vehicle,
- hydrostatic buoyancy force,
- hydrodynamic reactions of the flowing round water.

As, by assumption, the ship tows the rope with constant speed and does not change the direction, the rope axis is a two-dimensional curve.

The following formulae describe the hydrodynamic forces exerted on the rope by the flowing water:

$$\begin{aligned} F_n &= \frac{1}{2} * \rho_w * C_n * V_n * |V_n| * d \\ F_t &= \frac{1}{2} * \pi * \rho_w * C_t * V_t * |V_t| * d \end{aligned} \quad (8)$$

Equations of the rope equilibrium will be formulated in accordance with Fig. 4. It presents conditions of equilibrium of the rope loads and internal longitudinal force at an arbitrary point in the direction tangent and normal to the rope axis in the Ozx plane.

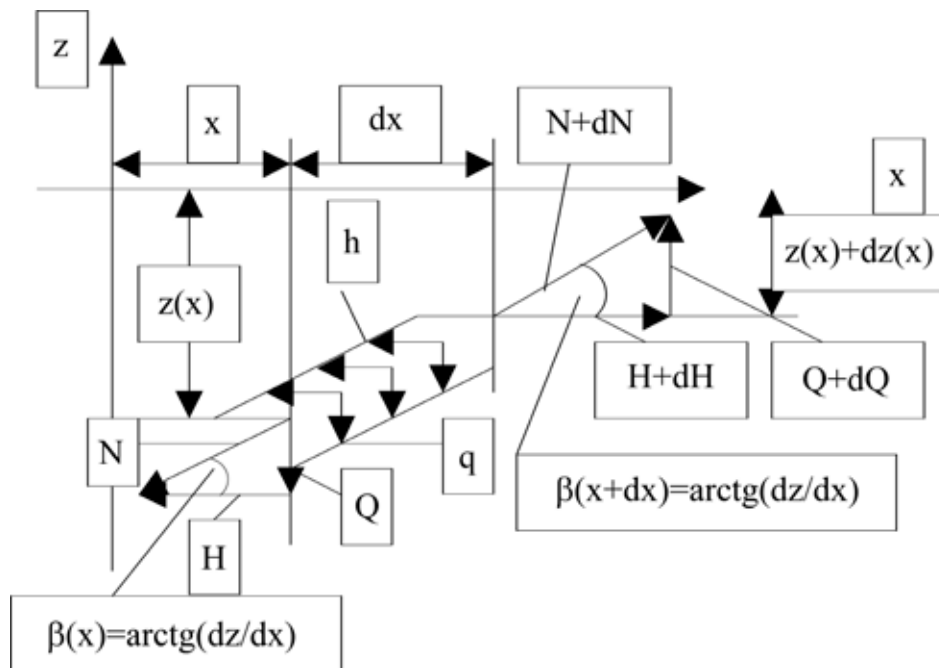

Fig. 4 The continuous horizontal and vertical load and internal longitudinal force impact on the element of rope.

The horizontal load on a rope element h is the horizontal component of the hydrodynamic reaction F generated by water flowing round the rope element. As shown in Fig. 4, the value is given by the following relation:

$$h = F_n \cdot \sin \beta + F_t \cdot \cos \beta \tag{9}$$

The continuous vertical load q is a sum of the rope element weight, buoyancy force in water and the vertical component of the hydrodynamic reaction F , given by the following relation:

$$q = (\rho_L - \rho_w) \cdot S_L \cdot g - F_n \cdot \cos \beta + F_t \cdot \sin \beta \tag{10}$$

Equation describing the rope shape is derived from values given in Fig. 4 and from differential relations $dH/dx=h$, $dQ/dx=q$ and has the following form:

$$\frac{d}{dx} \left(H \frac{dz}{dx} \right) = q \tag{11}$$

After differentiating (11) and introducing the coefficients, the rope shape equation takes the form:

$$H \cdot \frac{d^2z}{dx^2} + A_{Fn} \cdot \left(\frac{dz}{dx} \right)^4 + A_{Fn} \cdot \left(\frac{dz}{dx} \right)^2 - q_{00} = 0 \tag{12}$$

Solution of the problem

Calculations of the rope shape and forces during towing of an underwater vehicle were carried out by the finite element method in the Matlab computing environment. Own and library computational routines were used. A program was developed to calculate the hydrodynamic forces induced on the vehicle by the flowing-round water, based on the vehicle experimental data. The following boundary conditions were assumed for the calculations:

- at point B (connection of the rope and vehicle) the longitudinal rope tension force is equal to the sum of the towed vehicle resistance and the vertical component induced on the vehicle surface and rudders, mainly on the diving rudders, see Fig. 1 and equations (1);
- at point A (fixture of the rope on the ship) the height $z(A)$ of that point is known and also the total tension force in the rope as well as its inclination angle to the level $\beta(A)$ can be measured there.

The $x(A)$ coordinate defines the horizontal distance of the vehicle from the ship and it is determined by the rope length $L1$ and its shape dependent on many parameters, such as: rope material density, its diameter, presence or not of a supply cable, mass (density) of the underwater vehicle, ship speed and also the phase of motion - submergence or emergence or a horizontal motion of the vehicle at a specific depth. Both the shape of towrope and the generated forces depend on those parameters. The calculations allow to solve the design problems and to assist the operator by choosing an optimum rope length for a given

vehicle towing depth etc..

The described method is also applicable to a self-propelled vehicle. In such case a description of forces and moments generated by propellers should be added to the mathematical model. When the self-propelled vehicle performs very complex movements, with turns not only around the Gy1 axis but also around the Gx1 and Gz1 axes, the shape of the rope and the force system will be very complex. In order to be able to perform such complex space calculations, it is necessary to decrease the numerical difficulties of the boundary problem calculations by applying another method described by the author in [2].

Results of calculations

An example of calculations was performed for a vehicle with resistance of approx. 450 N at a speed of 6 knots. In Figs. 5-9 in Appendix I results are presented of the calculations of towing the vehicle with ropes of 50, 100, 150, 200 and 250 m length, respectively. The other data remained unchanged, with the following values:

- $z(A) = 5$ m – height of the rope fixture above the water surface, (Fig.1),
- h_0 – depth of the vehicle submergence, (Fig.1),
- $V_s = 6$ knots (kn), speed of the ship towing the rope and the underwater vehicle,
- $\rho_W = 1025$ kg/m³ – sea water density,
- $g = 9.81$ m/s² – gravitational acceleration,
- $d = 5e-3$ m – nominal diameter of the steel towrope,
- $\rho_L = 7e3$ kg/m³ – rope material density,
- $L_1 = 50$ m - 250 m – rope length, (Fig. 1),
- $C_n = 1.2$ – coefficient for a round cross-section rope, (equation (8)),
- $C_t = 2e-2$ - coefficient for a round cross-section rope, (equation (8)),
- $\rho_O = 1.030e3$ kg/m³ – average density of the vehicle material,
- $D_0 = \text{approx. } 7.5$ kN – vehicle displacement.

The calculation results are presented in Figs. 5-9, which show, respectively:

- a - inclination angle of the end of towrope at point B as a function of the vehicle submergence depth h_0 ;
- b - vertical force Q (as a function of the vehicle submergence depth h_0), which has to be generated by the diving rudders in order to balance the vertical component of the towrope force;
- c - total force induced on the vehicle, balancing the rope tension force N , also as a function of h_0 ;
- d - values of the rope tension horizontal component as a function of the horizontal coordinate x , for the rope shape corresponding to the maximum tow depth;
- e - shape of the towrope at different tow depths in the Oxz plane.

Fig. 5 presents results for a relatively short, 50 m long rope. It can be seen from the values of force Q that free float, understood as floating without the use of diving rudders, is impossible, already for $h_0 = 2$ m a force $Q = -50$ N must be generated by the rudders and it increases for $h_0 = 21$ m to a value of -400 N and is comparable with the total vehicle resistance, see Fig. 5b.

For a longer rope, $L_1 = 100$ m, Fig. 6 shows that free float is possible at the depth of $h_0 = 5.5$ m but at $h_0 = 21$ m the value of $Q = -200$ N is two times smaller than that for the $L_1 = 50$ m rope, see Fig. 6b.

For a rope of $L_1 = 150$ m, Fig. 7 shows that free float is possible at the depth of $h_0 = 15$ m but at $h_0 = 27$ m the value of $Q = -120$ N is 3.5-4 times smaller than that for the $L_1 = 50$ m rope, see Fig. 7b.

At the depth of $h_0 = 15$ m also the total tension force in the rope at point B of rope connection with the vehicle is smallest, see Fig. 7c.

For a rope of $L_1 = 200$ m, Fig. 8 shows that free float is possible at the depth of $h_0 = 25$ m, see Fig. 8b, but at $h_0 = 37$ m the value of $Q = -150$ N is 3 times smaller than that for the $L_1 = 50$ m rope at a $h_0 = 21$ m depth. At the depth of $h_0 = 25$ m also the total tension force in the rope at point B of rope connection with the vehicle is smallest, see Fig. 8c.

Fig. 9 for the rope length $L_1 = 250$ m shows that the vehicle can float freely at the depth greater than $h_0 = 35$ m, see Fig. 9b, but at $h_0 = 47$ m the value of $Q = -200$ N is 2 times smaller than that for the $L_1 = 50$ m rope at a $h_0 = 21$ m depth. At the depth of $h_0 = 35$ m also the total tension force in the rope at point B of rope connection with the vehicle is smallest, see Fig. 9c.

These calculation results indicate that it is possible to select an appropriate rope length for the expected submergence depth of the underwater vehicle. Such a rope length will allow the vehicle to float freely, which in turn, with the balanced vehicle weight and buoyancy forces, will allow the vehicle to be towed at a constant depth without the use of diving rudders. This ensures a very stable vehicle motion. When the vehicle weight and buoyancy forces are not balanced, only the difference between them has to be compensated by the diving rudders.

The above shown results of an optimum rope length for given parameters of the rope-vehicle system at the tow speed of 6 knots may be described by a third degree polynomial with the coefficient values as follows:

$$L_1 = f(h_0) = ax^3 + bx^2 + cx + d \quad (13)$$

$$a = 3.6333e-3; b = -0.236688; c = 9.5247358; d = 51.225642$$

The reverse function has the form:

$$h_0 = f(L_1) = ax^3 + bx^2 + cx + d \quad (14)$$
$$a = -2.666e - 6; b = 1.4714e - 3; c = -0.059761; d = -0.4$$

Summary.

The calculation results show how easily the forces considerably exceeding the towed vehicle resistance can be generated on the towrope. From formula (13) an optimum rope length can be determined for a given tow depth h_0 and formula (14) gives a reverse function. Evidently, the function coefficients will change when the conditions of movement or the rope and vehicle parameters are changed.

Operating a self-propelled underwater vehicle, with external energy supply in difficult conditions of a sea current of changeable direction and velocity, will require performing the vehicle motion simulations allowing to work out the best possible steering procedures.

References

- [1] J. Bielański, M. Bogdaniuk, Simulation of motions of an anchored ship under the wind and ocean current forces, 10th Conference on Fluid Mechanics, pp. 160-166, Gdańsk 1992.
- [2] J. Bielański, M. Bogdaniuk, The iterative method in search for the state of equilibrium in anchor ropes, Marine Technology Transactions, Polish Academy of Sciences, Vol.14, pp. 5-18, 2003.
- [3] J. Bielański, The analysis of the system towing rope with long underwater object, Hydroacoustics, European Acoustics Association, Committee on Acoustics of the Polish Academy of Sciences, Vol. 9, pp. 9-16, 2006.
- [4] Ronghua Li, Zhongying Chen, Wei Wu, Generalized difference methods for differential equations, Marcel Dekker, Inc., pp.1-442, New York 2000.
- [5] Jaan Kiusallaas, Numerical methods on engineering with Matlab, Cambridge University Press, pp.1-426, Cambridge 2005.
- [6] Wong Young Yang, Wenwu Cao, Tae-Sang Chung, John Morris, Applied numerical methods using Matlab, Wiley-Interscience, pp.1-509, New Jersey 2005.



NOMENCLATURE

- A_{Fn} - coefficient of the continuous load normal to rope axis ; $A_{Fn} = \frac{1}{2} \cdot \rho W \cdot V_s^2 \cdot d \cdot C_n$
 A_{Ft} - coefficient of the continuous load tangent to rope axis; $A_{Ft} = \frac{1}{2} \cdot \rho W \cdot V_s^2 \cdot d \cdot \pi \cdot C_t$;
 $CD(\alpha)$ – coefficient of the plane resistance with the following relation to the angle of incidence: $CD = k_0 + k_D \cdot \alpha^2$;
 $CDS(V_s, \gamma)$ – coefficient of the vehicle resistance with the relation to the angle of incidence in the form of a quadratic function: $CDS(V_s, \gamma) = k_0S(V_s) + k_DS(V_s) \cdot \gamma^2$, coefficients depend on the Reynolds number and are also a function of the flow speed V_s ;
 $CL(\alpha)$ – coefficient of the plane hydrodynamic lift force with the relation to the angle of incidence in a linear form: $CL = k_L \cdot \alpha$;
 $CLS(V_s, \gamma)$ – coefficient of the vehicle-generated hydrodynamic lift force with the relation to the angle of incidence, for small angles, in an approximately linear form: $CLS(V_s, \gamma) = k_{LS}(V_s) \cdot \gamma$;
 $CMS(V_s, \gamma)$ – coefficient of the vehicle-generated moment with the relation to the angle of incidence, for small angles, in an approximately linear form: $CMS(V_s, \gamma) = -k_{MS}(V_s) \cdot \gamma$;
 C_n, C_t – dimensionless coefficients dependent on the rope cross-section shape;
 d – characteristic dimension of the rope cross-section, for a circular rope the diameter, for a rope-cable set the hydrodynamic forces induced by water flow on the rope and on the cable must be calculated separately;
 DH, DST – resistance force generated on the bow and stern diving rudder, respectively;
 D_0 – underwater vehicle displacement;
 F_n – rope continuous load normal to the rope axis, $F_n = A_{Fn} \cdot \sin 2\beta$;
 F_t – rope continuous load tangent to the rope axis, $F_t = A_{Ft} \cdot \cos 2\beta$;
 g – gravitational acceleration;
 G_0 – vehicle weight;
 h – rope continuous horizontal load;
 h_0 - submersion depth of the underwater vehicle;
 H – horizontal component of the rope tension force;
 L_1 – towrope length between points A and B;
 LH, LST – hydrodynamic lift force generated on the bow and stern diving rudder, respectively
 MG_y – resultant moment from the hydrodynamic forces acting on the vehicle hull and from forces generated on the vehicle diving rudders and also from the towing force;
 N – rope tension force;
 G_x1y1z1 - mobile coordinate system connected with the underwater vehicle, moving with speed V_s ;
 $Oxyz$ – mobile coordinate system connected with the ship, moving with speed V_s ;
 O_x – horizontal component on the sea surface;
 O_z – vertical component;
 q – rope continuous vertical load;
 q_0 – swell pressure;
 q_{00} – coefficient of rope continuous vertical load as a difference of the rope weight and displacement, $q_{00} = (\rho_L - \rho_W) \cdot SL \cdot g$;
 R_L – reaction in rope balancing the R_0 reaction generated on the vehicle, $R_L = R_0$;
 R_0 – reaction generated on the underwater vehicle;
 R_{x0} – horizontal component of the R_0 reaction;
 R_{z0} – vertical component of the R_0 reaction;
 SL – rope cross-section area;
 $SpH, SpST$ – surface area of the bow and stern diving rudder, respectively;
 Sw – wet surface of the vehicle hull;
 V_n, V_t – coordinates of the water speed vector projections on the direction normal and tangent to the rope axis, respectively;
 V_0 – vehicle displacement volume;
 V_s – speed of the towing unit;
 α_H – angle of incidence of the bow diving rudders, positive direction anticlockwise;
 α_{ST} – angle of incidence of the stern diving rudders, positive direction as above.;
 β - angle of the towrope inclination to the level, positive direction anticlockwise;
 β_0 – angle of deviation of the hydrodynamic reaction generated by water flowing around the vehicle, the direction determines also the angle of towrope inclination to the level at point B;
 γ – angle of rotation of the underwater vehicle around the Oy_1 axis, parallel to the Oy axis and passing through the vehicle centre of gravity G ;
 ρ_L - rope material density;
 ρ_0 – average vehicle density, weight of the vehicle divided by its volume;
 ρ_W – sea water density;

APPENDIX

Beta - the angle inclination to horizon of the rope end

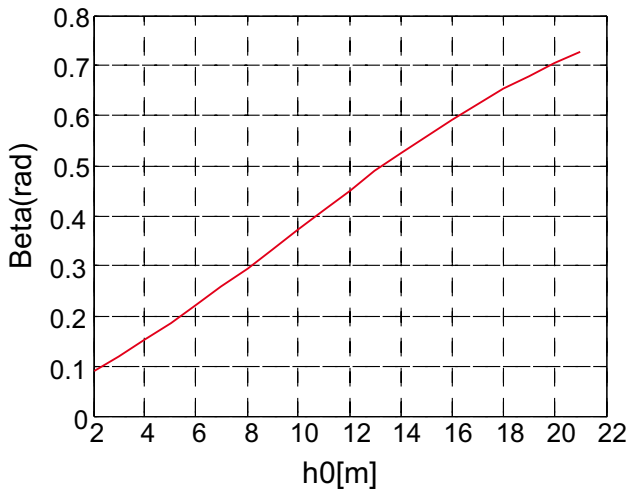

Q - the vertical force generated on diving plane of submarine

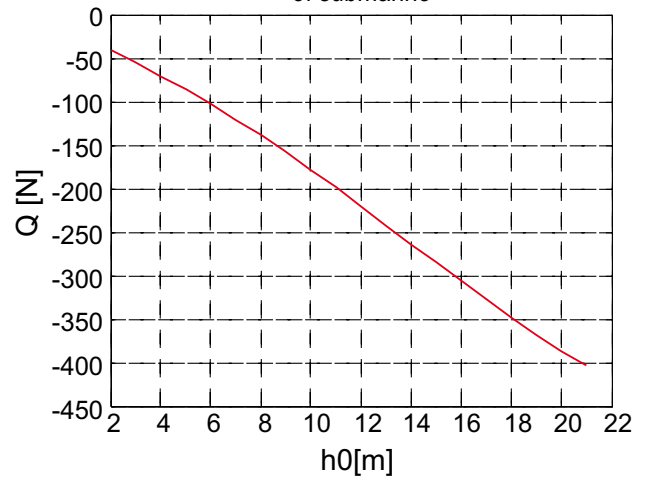

N - the total force generated on submarine

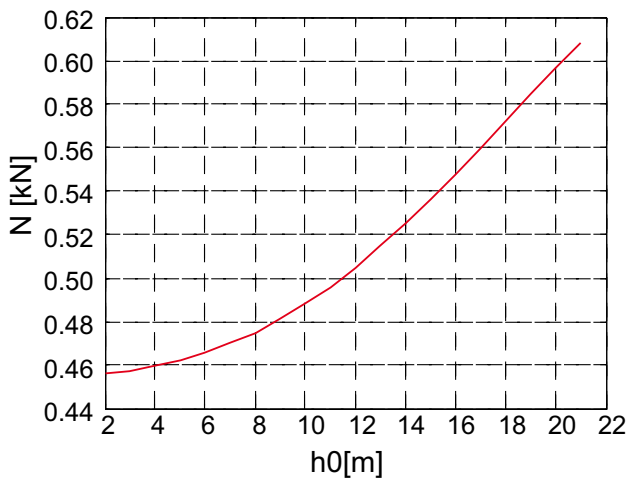

H(x)-[o] the horizontal component and N(A)-[x] total of internal longitudinal force in the rope

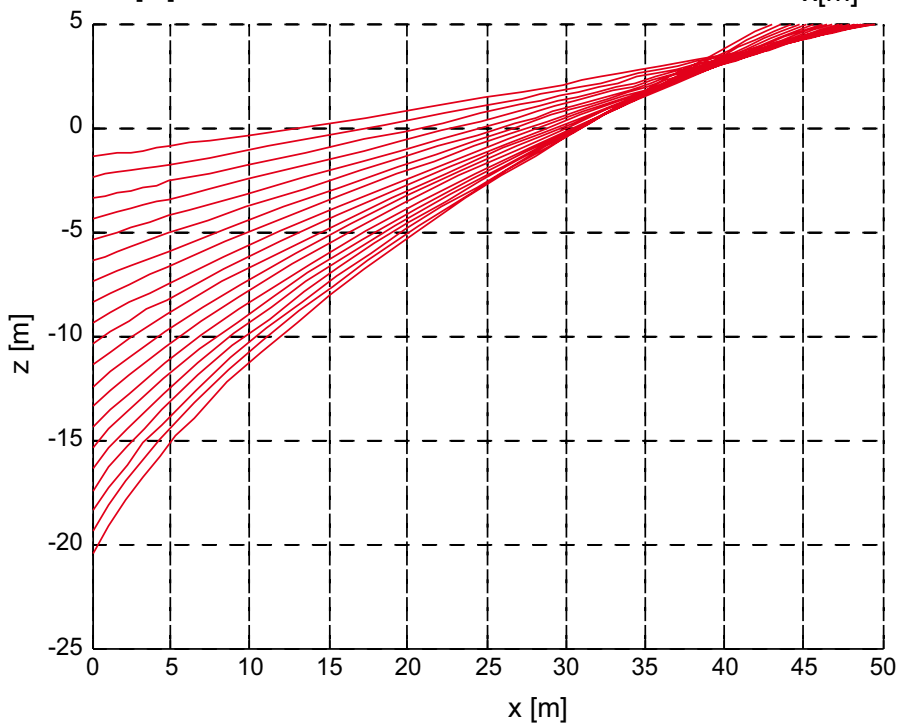
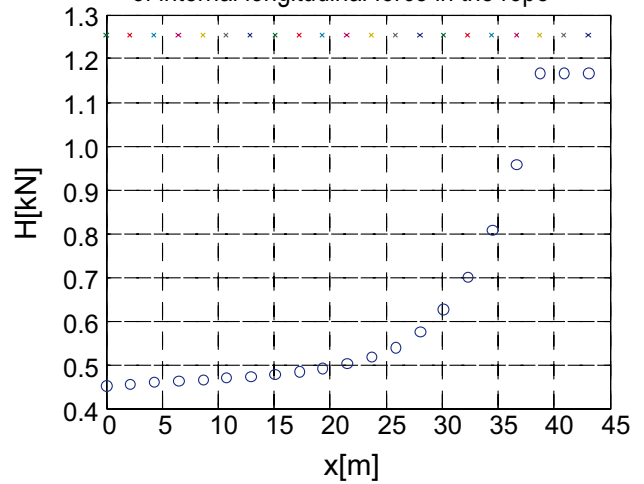

Beta - the angle inclination to horizon of the rope end

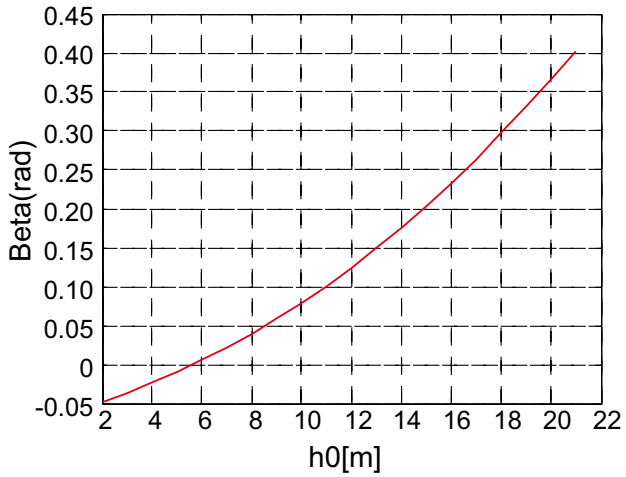

Q - the vertical force generated on diving plane of submarine

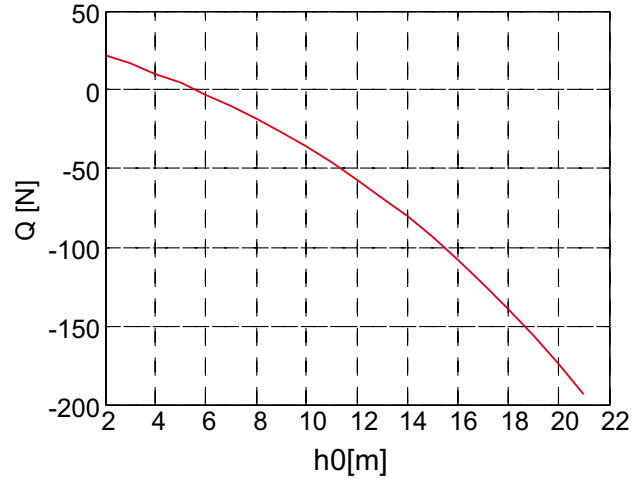

N - the total force generated on submarine

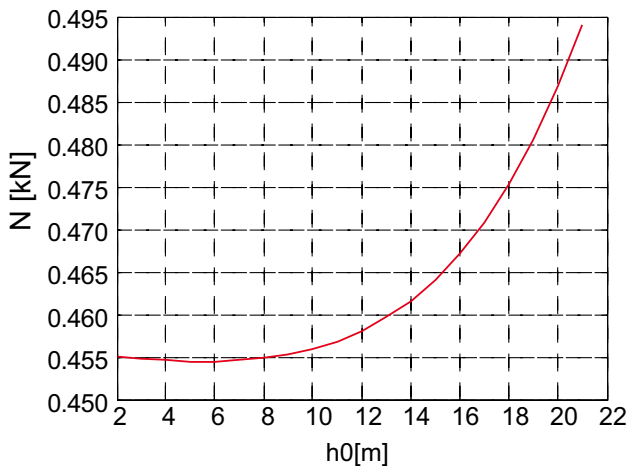

H(x)-[o] the horizontal component and N(A)-[x] total of internal longitudinal force in the rope

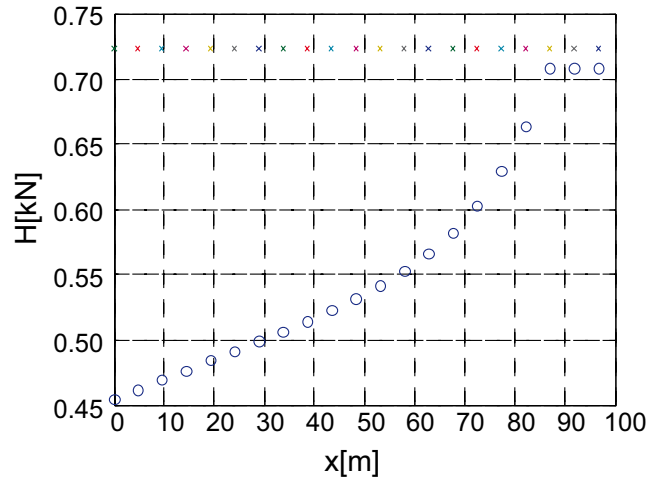

The shape of the rope with submarine calculated for velocity 6 knots

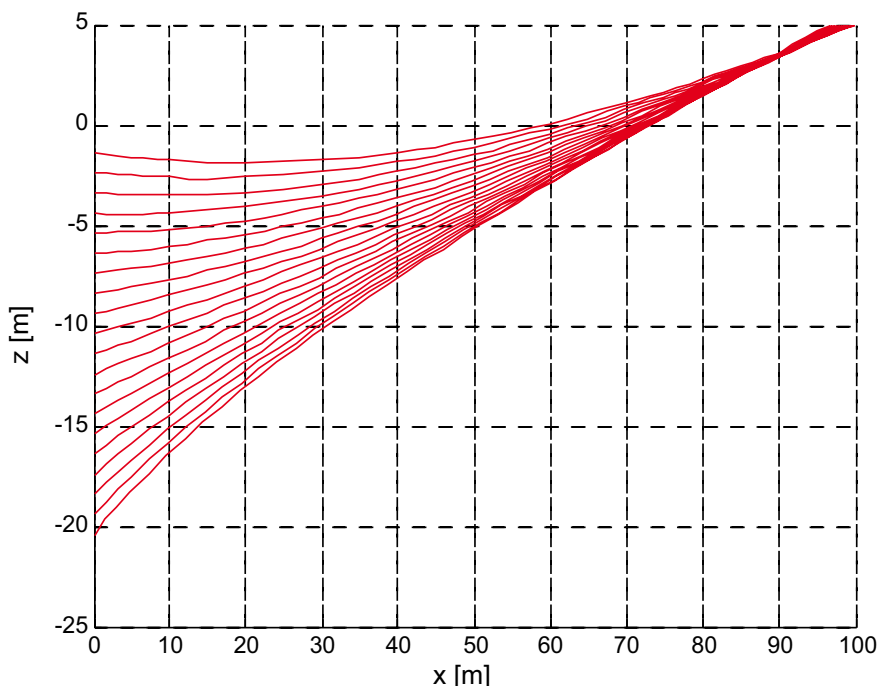

Beta - the angle inclination to horizon of the rope end

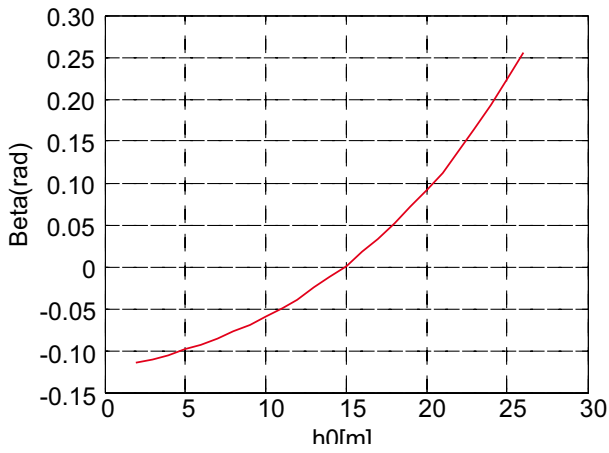

Q - the vertical force generated on diving plane of submarine

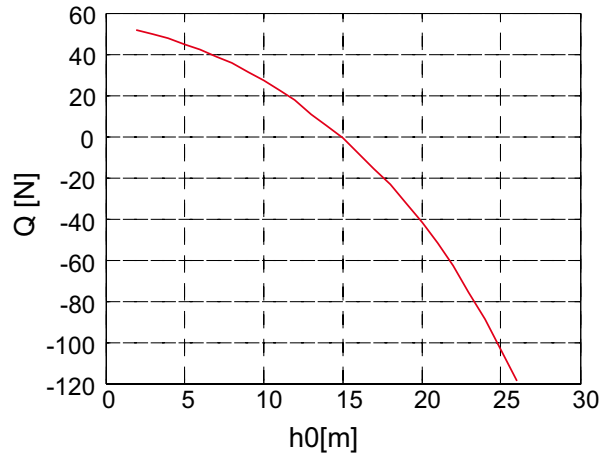

N - the total force generated on submarine

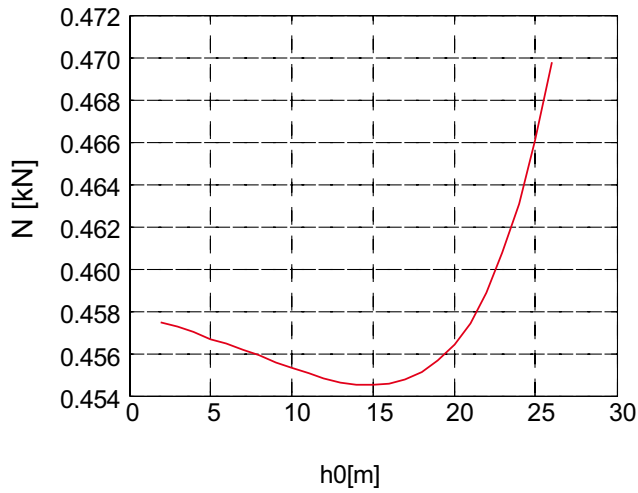

H(x)-[o] the horizontal component and N(A)-[x] total of internal longitudinal force in the rope

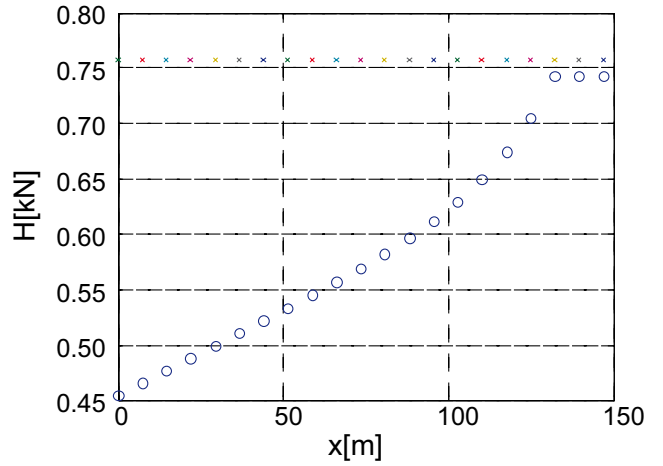

The shape of the rope with submarine calculated for velocity 6 knots

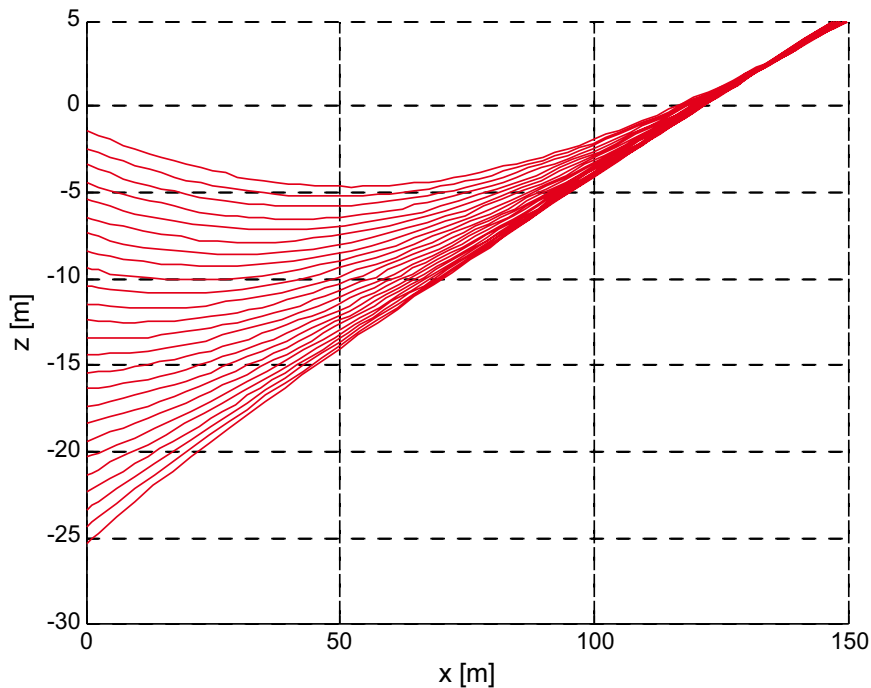

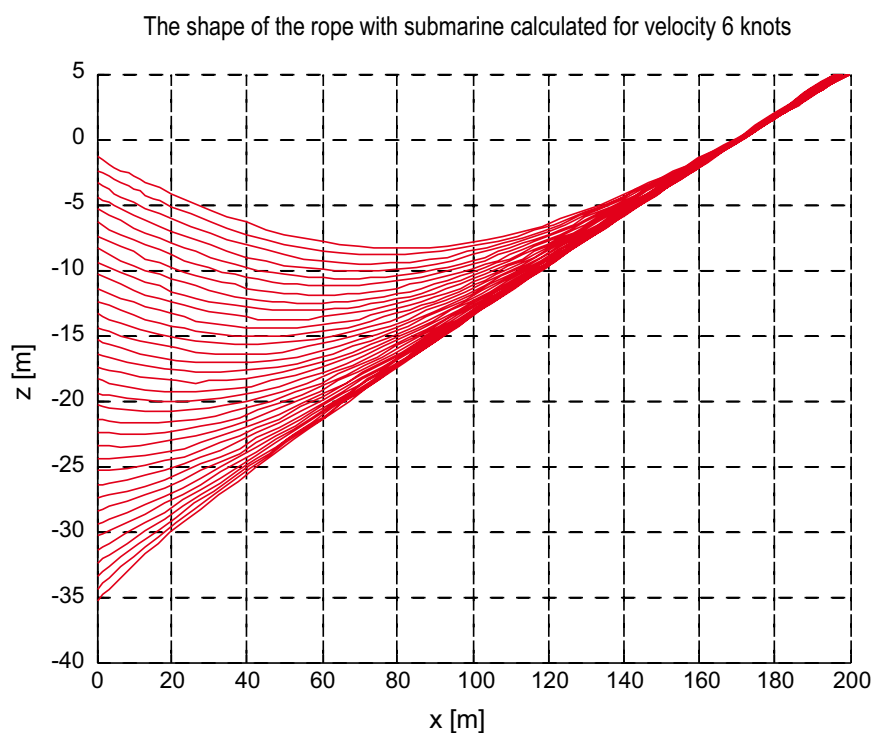
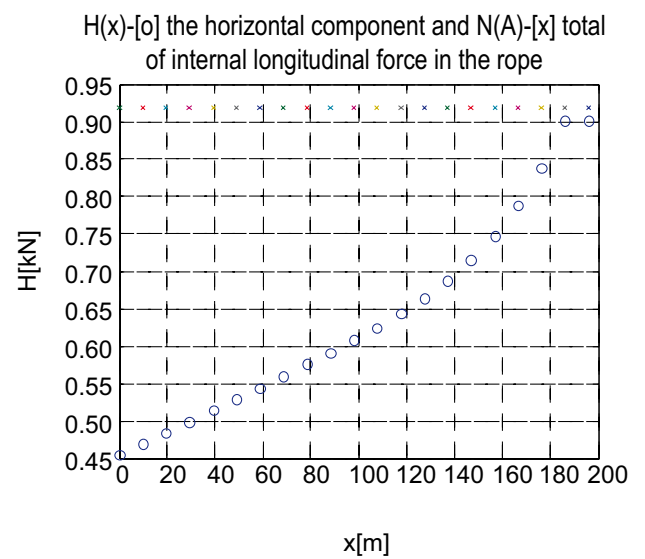
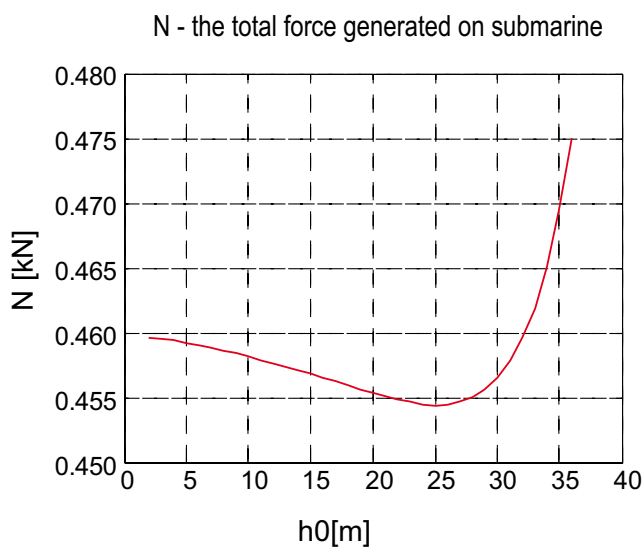
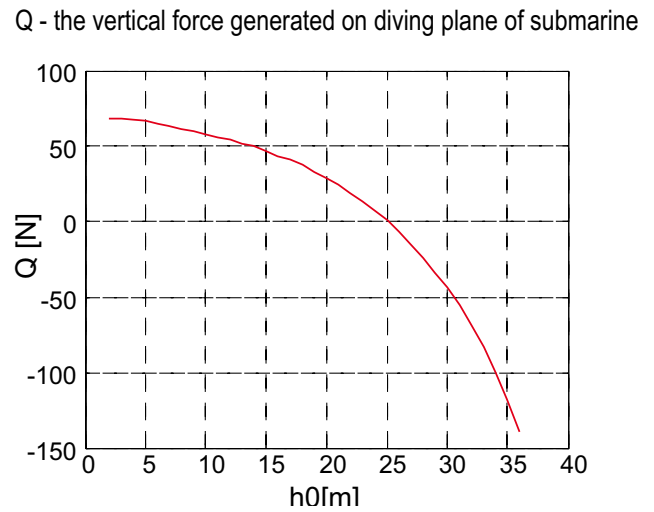
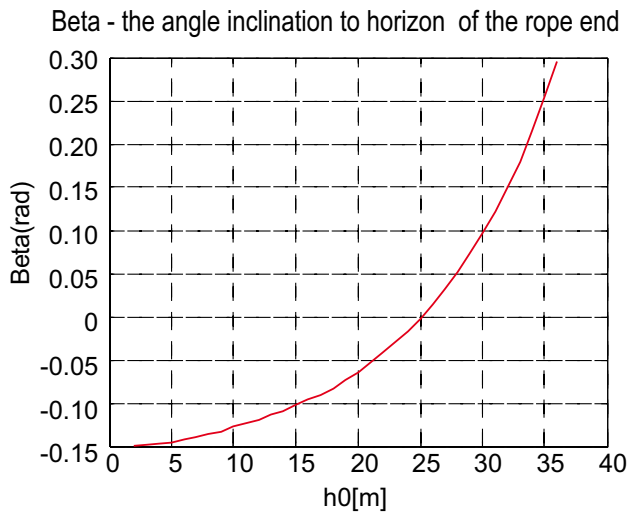

Beta - the angle inclination to horizon of the rope end

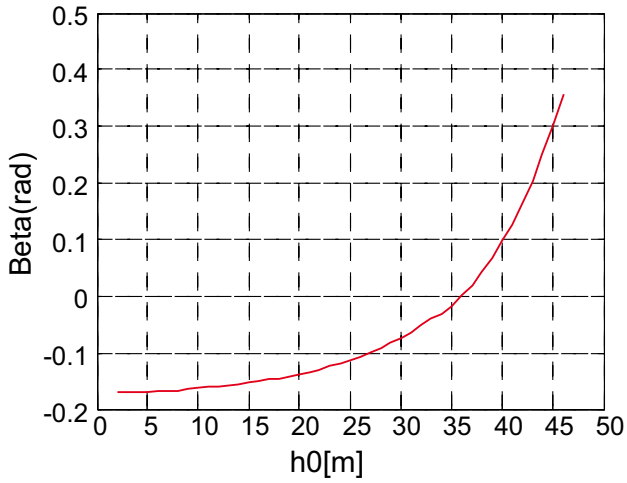

Q - the vertical force generated on diving plane of submarine

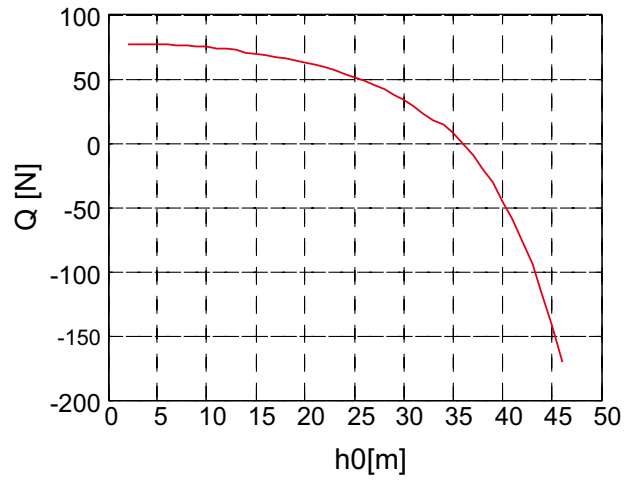

N - the total force generated on submarine

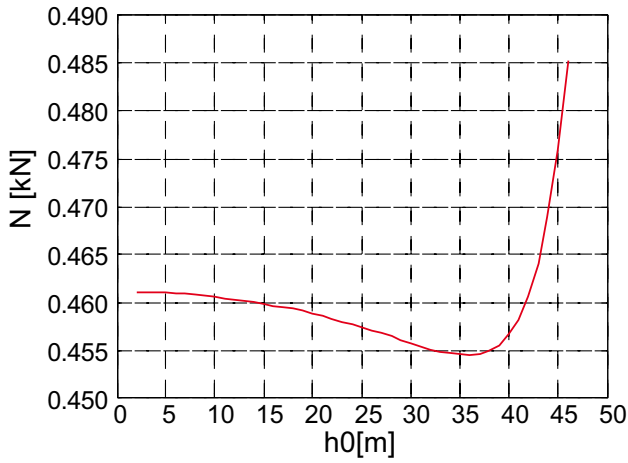

H(x)-[o] the horizontal component and N(A)-[x] total of internal longitudinal force in the rope

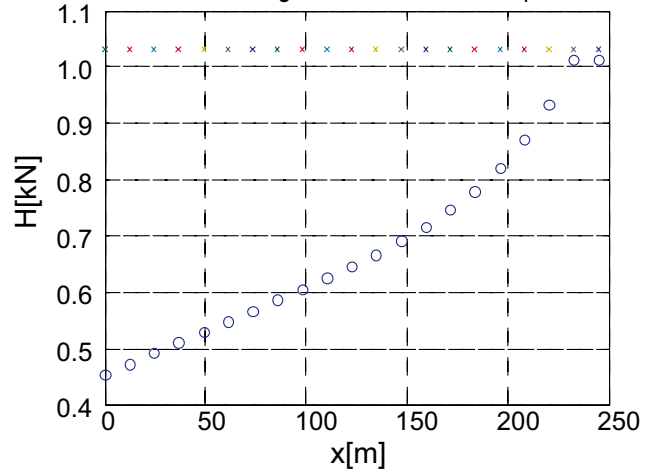

The shape of the rope with submarine calculated for velocity 6 knots

