

PAPER • OPEN ACCESS

Thermal performance of a prototype plate heat exchanger with minichannels under boiling conditions

To cite this article: J Wajs *et al* 2016 *J. Phys.: Conf. Ser.* **745** 032063

View the [article online](#) for updates and enhancements.

You may also like

- [Characterization of a mini-channel heat exchanger for a heat pump system](#)
A Arteconi, G Giuliani, M Tartuferi *et al.*
- [A study of the flow boiling heat transfer in a minichannel for a heated wall with surface texture produced by vibration-assisted laser machining](#)
Magdalena Piasecka, Kinga Strk, Beata Maciejewska *et al.*
- [Condensation heat transfer in minichannels: a review of available correlations](#)
M Azzolin, A Berto, S Bortolin *et al.*

PRIME
PACIFIC RIM MEETING
ON ELECTROCHEMICAL
AND SOLID STATE SCIENCE

HONOLULU, HI
Oct 6-11, 2024

Abstract submission deadline:
April 12, 2024

Learn more and submit!

Joint Meeting of
The Electrochemical Society
•
The Electrochemical Society of Japan
•
Korea Electrochemical Society

Thermal performance of a prototype plate heat exchanger with minichannels under boiling conditions

J Wajs¹, D Mikielewicz¹ and E Fornalik-Wajs²

¹Gdansk University of Technology, Department of Energy and Industrial Apparatus, Narutowicza 11/12, 80-233 Gdansk, Poland

²AGH University of Science and Technology, Department of Fundamental Research in Energy Engineering, Al. Mickiewicza 30, 30-059 Krakow, Poland

E-mail: janwajs@pg.gda.pl

Abstract. To solve the problem and to meet the requirements of customers in the field of high heat fluxes transfer in compact units, a new design of plate heat exchanger with minichannels (minichannels PHE) was proposed. The aim was to construct a compact heat exchanger of high effectiveness for the purpose of household cogeneration ORC system. In this paper the experimental analysis of an assembled prototype of such compact heat exchanger was described. The attention was paid to its thermal performance and the heat transfer coefficients under the boiling conditions. Water and ethanol were chosen as working fluids. The maximal value of transferred heat flux was about 84 kW/m^2 , while of the overall heat transfer coefficient was about $4000 \text{ W/(m}^2\text{K)}$. Estimated values of heat transfer coefficient on the ethanol (boiling) side reached the level of $7500 \text{ W/(m}^2\text{K)}$. The results are promising in the light of future applications, for example in cogeneration ORC systems, however further systematic investigations are necessary.

1. Introduction

Heat transfer processes are very important for all engineering systems as well as for energy conversion and environment protection. Among the ways toward systems efficiency improving, the various heat transfer enhancement techniques can be found. Generally speaking, the intensification methods can be classified as passive (no additional energy is needed to be supplied) and active (additional energy is required). Effectiveness of such methods strongly depends on heat transfer conditions and mechanisms which usually vary from single-phase convective heat transfer to the flow boiling.

With the prospects of energy efficiency, miniaturization, product reliability, and the potentially large economic advantages, an extensive research and development effort has been undertaken in the area of enhanced heat transfer over the past couple of decades. The techniques of heat transfer intensification in conventional applications have been under scrutiny in literature for more than century and a large number of information was gathered up to date [1,2,3,4]. A state-of-the-art overview of the selected enhancement techniques, specifically provided for single-phase flow and flow boiling enhancement in micro/minichannels, was done in [5]. General overview of heat transfer (in the flow passages) augmentation by passive methods can be also found in [6], while [7] concentrated on the heat transfer intensification in compact heat exchangers. The methods of enhancement evaluation by various parameters followed by overview of heat exchangers geometries including many kinds of fins, wavy and corrugated channels, etc. were also described.



Over the past 20 years, plate heat exchangers have replaced the traditional shell-and-tube heat exchangers, since they are more energy and space efficient and are therefore cheaper to produce. Typical heat exchangers with corrugated plates are considered as compact, because their heat transfer area density can be up to $700 \text{ m}^2/\text{m}^3$. Hydraulic diameters of pressed channels are within the range 2-10 mm [8]. Heat exchangers of such construction are assigned both to general applications (energy engineering, technological processes, heating, air-conditioning, ventilation, refrigeration) and more specific like for the waste energy recovery from low temperature resources. They can operate under single-phase and two-phase conditions. Even higher “compactness” in comparison with presented above units, are having the heat exchangers with microchannels obtained by chemical wet etching method. They are known as Printed Circuit Heat Exchangers (PCHE). In example, for heat exchangers assembled with application of diffusion bonding technology, offered by CorHex, the heat transfer area density can be of about $1500 \text{ m}^2/\text{m}^3$ [9]. Other group of plate heat exchangers (still being under the laboratory tests) are these with microjet technology [10].

Since many years the authors are conducting the investigations regarding the methods of heat transfer enhancement causing better performance of plate heat exchangers. Their concern is on the typical plate heat exchangers [11,12], but also on the compact ones with microjets [13,14]. In this paper new design of minichannels plate heat exchanger (minichannels PHE) was proposed. The aim was to construct a compact heat exchanger of high performance for purpose of household cogeneration ORC system. The experimental analysis of an assembled prototype was described.

2. Prototype minichannels plate heat exchanger

In figure 1 the prototype minichannels PHE is presented. It consisted of twisted brazed plates series with the channels of rectangular crosssection ($a = 1 \text{ mm}$ width, $b = 700 \text{ }\mu\text{m}$ depth) and of 40 mm length. Distance between the channels was equal to 1 mm. Design of the minichannel PHE plate is shown in figure 2.



Figure 1. View of PHE prototype with minichannels.

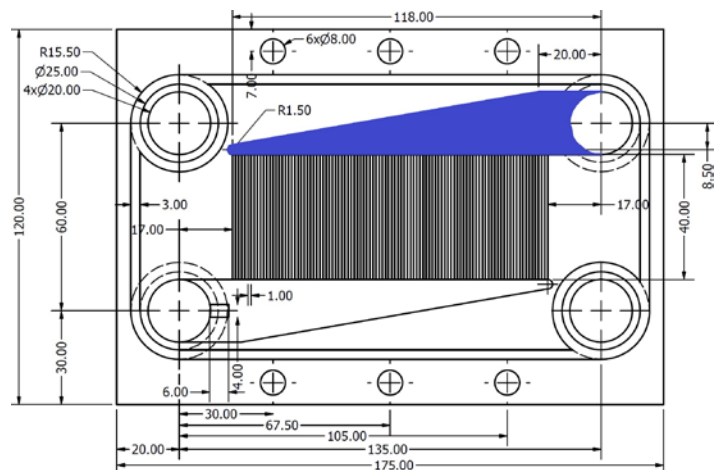

Figure 2. Schematic drawing of PHE plate with minichannels.

In each plate the special collectors for distribution of working media to the parallel minichannels were designed (see blue shape in figure 2). Their depth was 1 mm, but the width was varied from 4 mm to 20 mm. Such geometry of collectors came from the requirement of constant mass in-flow rate assurance for the minichannels. A tightness of heat exchanger unit was guaranteed by the special gasket groove and additional openings for strong holding down. The Teflon gasket was used in the analyzed model. The heat transfer plate between heating and cooling media was finned and its total area was 0.00694 m^2 . Experimentally analyzed PHE with minichannels consisted of three plates (as in

figure 1), however such geometry can be easily extended by addition of the subsequent plates. Simple geometry helped to analyze its heat transfer effectiveness and to understand the physical processes involved. The description of constructional details was reported in [15].

Presented prototype of heat exchanger was constructed to increase transferred heat flux. To verify if its geometry fulfills the requirements it was compared with corrugated plate heat exchanger (corrugated PHE) commercially available. The corrugated PHE was made of stainless steel 316 according to AISI standard and consisted of three plates, with thickness of each one of 0.5 mm. The overall heat transfer area was equal to 0.039 m^2 [11]. In figures 3 and 4 the exemplary results of such comparison are presented. The direct comparison between both devices was possible due to the assurance of equivalent conditions during the experiment. Equivalent conditions mean the same volumetric flow rates and the same media temperatures at the inlet of heat exchangers in the corresponding measurement series. The heat flux values at water flow rate 50 l/h and 125 l/h and various ethanol flow rates are higher for proposed minichannels PHE than the corrugated one. Analysis of single-phase convection proved that the heat transfer was intensified. Therefore, the next step was done in the direction of two-phase phenomena and is presented in this paper.

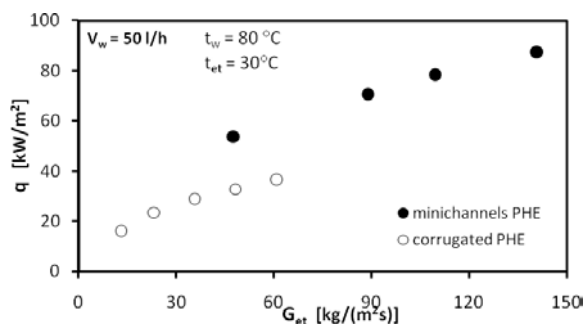

Figure 3. Comparison of heat flux value between minichannels and corrugated PHEs for single-phase convection at water flow rate of 50 l/h and various ethanol mass flux.

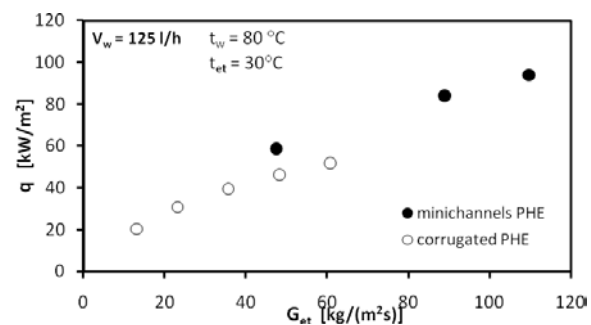

Figure 4. Comparison of heat flux value between minichannels and corrugated PHEs for single-phase convection at water flow rate of 125 l/h and various ethanol mass flux.

3. Experimental facility

Analyses of proposed heat exchanger were conducted on the facility, which schematic view is shown in figure 5, assembled in Department of Energy and Industrial Apparatus at Gdansk University of Technology.

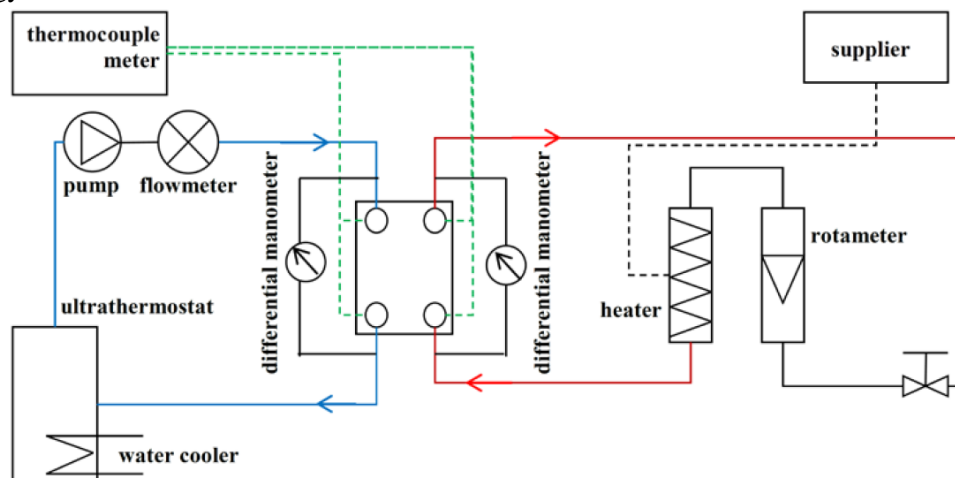

Figure 5. The scheme of experimental facility.

The model unit was tested under boiling conditions of ethanol. Water was acting as the heating medium. Both media were flowing in the counter-current configuration. The stream of water was first directed to the rotameter and then to the electrical heater to obtain a proper parameters at the inlet to heat exchanger. The heater was controlled by an autotransformer, which allowed smooth change of heater power and then the precise water temperature settings.

The ethanol was circulating in a closed system equipped with ultrathermostat, which heated it to a certain level before entering the heat exchanger. For the needs of experiment an additional heat exchanger, supplied with the tap water (cold) was provided to the ultrathermostat. Because of that the thermal energy gained by the ethanol could be withdrawn from it, what assured the stationary state of the analysis.

During experiments the water volume flow rate (\dot{V}_w) was measured by rotameter V31 (by Heinrichs). Its measurement range was from 50 l/h to 500 l/h and its accuracy class was 1. The ethanol volume flow rate (\dot{V}_{et}) was measured by the calibrated rotameter. The volume flow rate of hot water varied in the range from 125 to 175 l/h (which corresponds to the range of water mass flux G_w ranging from 972 to 1360 kg/(m²s) in a single rectangular channel), while the ethanol one varied in the range from 14 to 22 l/h (which corresponds to the range of ethanol mass flux G_{et} from 47 to 102 kg/(m²s) in a single rectangular channel). Temperature of the hot water supplying the heat exchanger (t_w) was in the range 91-100.5°C, whereas the temperature of ethanol entering the heat exchanger was about 80°C. Ethanol was preliminarily heated to make the boiling heat transfer inside heat exchanger the most effective. It was delivered to the heat exchanger with subcooling of 3 K in relation to its saturation temperature controlled by ultrathermostat. It means, that the flow rate measurements were done, when ethanol had temperature near saturation state and was still liquid.

Thermocouples of K-type (Czaki, TP-201-1a) were used to measure temperature in four locations i.e. at the inlet and outlet of heat exchanger cooling side and at the inlet and outlet of heat exchanger heating side. The thermocouples' signal was recorded by the acquisition system CROPICO 3001 having an internal stabilizer of reference temperature.

4. Thermal characteristics

On the basis of measurement results the heat flux (q), the Logarithmic Mean Temperature Difference (LMTD, Δt_{log}) in the heat exchanger and the overall heat transfer coefficient (k) were calculated. The overall heat transfer coefficient was determined with the aid of the Peclet's law based on the heat transfer area equal to 0.00896 m² and average value of the heat rate transferred through the wall in a given measurement series. It should be emphasized that the total area taken for these calculation was higher than the area of 0.00694 m², mentioned before. The total area was calculated from the wetted perimeter of one minichannel, its length and the minichannels number. The collectors area was also taken into account since it was about 23% of total area and it had a great influence on the heat rate.

In figures 6 and 7 the thermal characteristics of investigated heat exchanger are presented. In figure 6, the transferred heat rate depended on the ethanol mass flux, while in figure 7 the overall heat transfer coefficient as function of the same parameter. Since the prototype minichannels PHE was designed for the purpose of heat recovery, therefore the mass flux of heating fluid was fixed at certain levels. That is why, two heating water mass fluxes (G_w) were considered (plus additional one in some cases) for constant saturation temperature of ethanol ($t_{S_{et}}$) in the heat exchanger. For higher values of the heating water mass flux an increase in the transferred heat rate and overall heat transfer coefficient were observed.

Decreasing values of transferred heat rate and overall heat transfer coefficient with increasing values of ethanol mass flux were also found. This tendency came from the specific methodology assumed for this stage of experiment. For constant values of water mass flux and water inlet temperature, increase in the ethanol mass flux caused less intensive boiling (see figures 10 and 11). In such situation the input heat rate was not sufficient to keep the boiling at particular level. Second reason was connected

with water boiling prevention, that is why the temperature difference between the ethanol and water was low and equal of about 11-19 K, what influenced the whole heat transfer process.

In figures 8 and 9 the heat flux and the overall heat transfer coefficient are presented as the functions of logarithmic mean temperature difference (Δt_{log}). The figures were assigned for two values of water mass flux ($G_w=1166 \text{ kg}/(\text{m}^2\text{s})$ and $G_w=1360 \text{ kg}/(\text{m}^2\text{s})$) and the constant saturation temperature equal to $t_{s_et}=79.6^\circ\text{C}$. In both cases the increase of analyzed parameters was accompanying an increase in the logarithmic mean temperature difference.

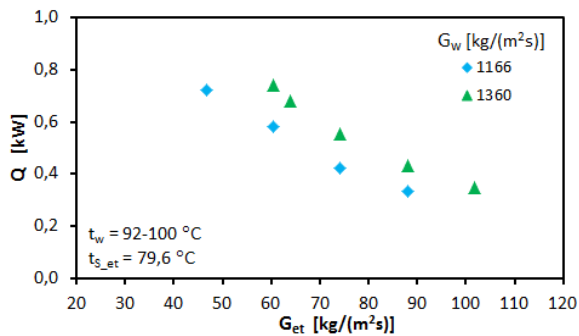

Figure 6. Rate of heat versus the ethanol mass flux.

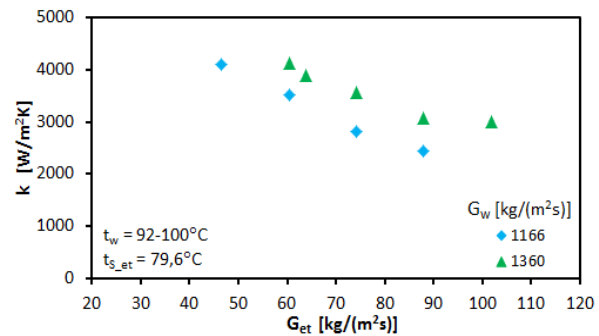

Figure 7. Overall heat transfer coefficient versus the ethanol mass flux.

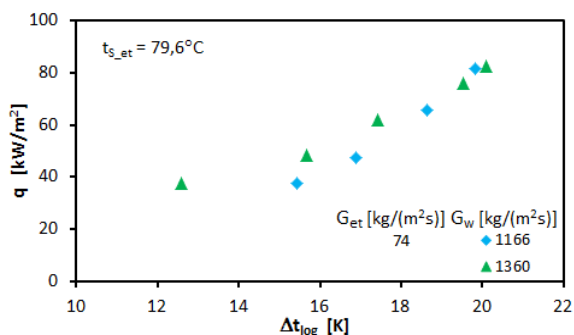

Figure 8. Heat flux versus the logarithmic mean temperature difference.

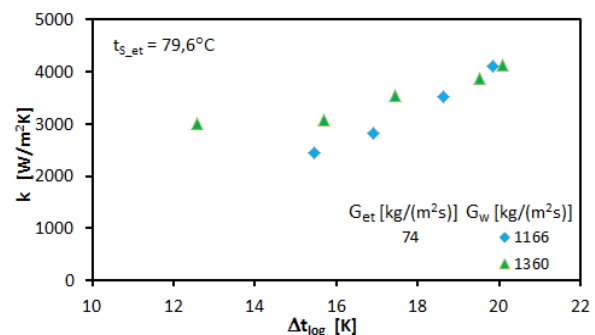

Figure 9. Overall heat transfer coefficient versus the logarithmic mean temperature difference.

The influence of water flow Reynolds number on the heat flux and overall heat transfer coefficient is demonstrated in figures 10 and 11. Both characteristics were obtained for the ethanol mass fluxes equal to $G_{et}=60 \text{ kg}/(\text{m}^2\text{s})$ and $G_{et}=74 \text{ kg}/(\text{m}^2\text{s})$. The Reynolds number of water flow in one minichannel was defined as:

$$\text{Re}_{w_1ch} = \frac{G_w D_H}{\mu}, \quad (1)$$

where μ is the dynamic viscosity taken from [16] for the average water temperature, D_H is the hydraulic diameter of minichannel ($D_H = 0.8235 \text{ mm}$) and G_w is the mass flux described by the formula:

$$G_w = \frac{\dot{m}_w}{n \cdot a \cdot b}, \quad (2)$$

where \dot{m}_w is the water mass flow rate, n is the number of minichannels, a and b denote the width and depth of the minichannels, respectively. In both cases the increasing tendency is observed.

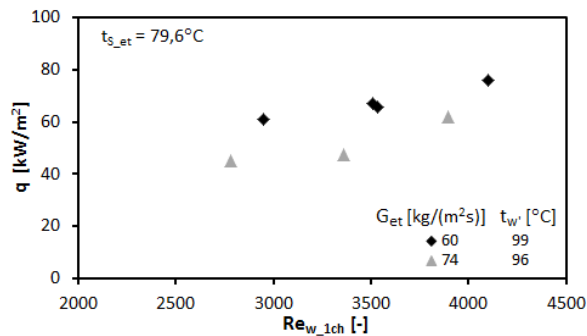

Figure 10. Heat flux versus the water flow Reynolds number for one minichannel.

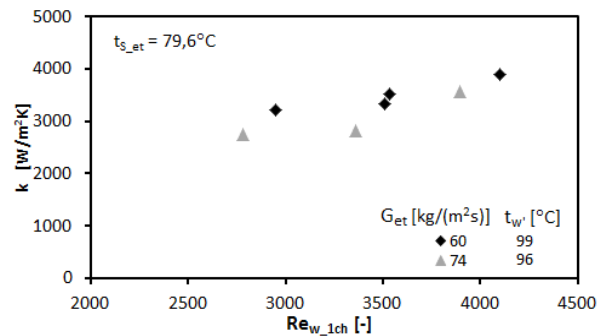

Figure 11. Overall heat transfer coefficient versus the water flow Reynolds number for one minichannel.

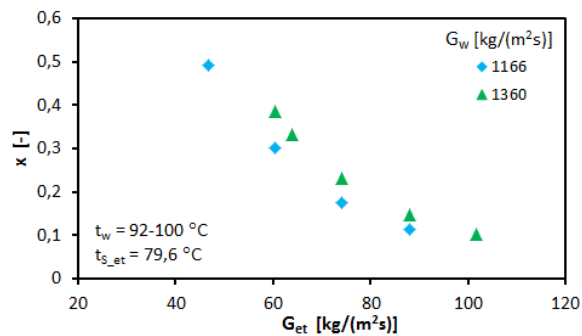

Figure 12. Quality of ethanol vapour at heat exchanger outlet versus the ethanol mass flux.

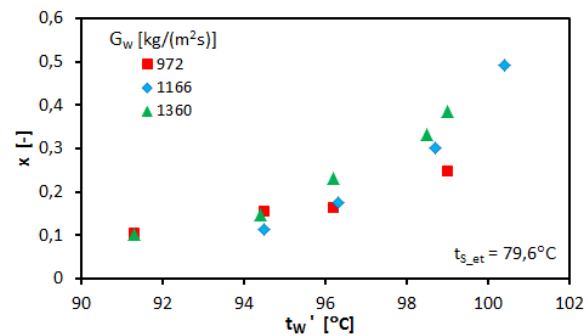

Figure 13. Quality of ethanol vapour at heat exchanger outlet versus the inlet water temperature.

The quality of ethanol vapour is the parameter, which represents the intensity of heat transfer, because it depends on the boiling process and its conditions. In figures 12 and 13 the quality of ethanol vapour versus the ethanol mass flux and the water inlet temperature are shown. The water mass flux and ethanol saturation temperature were constant for corresponding measurement series. Maximal value of ethanol vapor quality obtained in the studies was 0.5. It was not possible to obtain higher values of quality due to the limitations described in relation to figures 6 and 7. Shortly speaking, assumption of constant water mass flux and its inlet temperature led to the restrained input heat rate and altered intensity of boiling. In figure 13 an additional measurement series for water mass flux of $G_w=972$ kg/(m²s) was shown to verify an influence of as many parameters as possible.

5. Heat transfer coefficients

Very useful method for determination of heat transfer coefficient value is Wilson method [17]. However, it is mainly dedicated to single-phase heat exchangers. Principles of this method cannot be fulfilled in the analysis of two-phase convection, due to the variable flow rate, which according to Wilson method, should be kept constant once for heating fluid and once for the cooling one. Due to the boiling phenomena it was not possible to keep constant flow rate of the ethanol. Therefore the estimation of heat transfer coefficients was based on the known correlations defining the Nusselt number. The single-phase convection is well described by the empirical correlations, which reflect the physical phenomena. Different situation is in the case two-phase convection, where still extensive research is undertaken to define the correlation, which is not limited to narrow range of applications. Therefore the single-phase heat transfer coefficient estimation is characterized by the lower

uncertainties than the two-phase one, especially in the flow boiling region, that is why it was chosen to calculate it as a base for further studies. The heat transfer coefficients for the ethanol boiling side were calculated from the equation defining the overall thermal resistance:

$$\frac{1}{k} = \frac{1}{\alpha_w} + \frac{\delta}{\lambda} + \frac{1}{\alpha_{et}}, \quad (3)$$

where k is the overall heat transfer coefficient, α_w is the heat transfer coefficient on water side, δ is the thickness of heat transfer partition, λ is the thermal conductivity of heat transfer partition and α_{et} is the heat transfer coefficient on ethanol side.

It should be pointed out that the value of overall heat transfer coefficient (k) was calculated from Peclet law on the basis of measured temperature values and was presented in previous section.

According to the literature [18] application of Dittus-Boelter correlation applied in the analysis of minichannels causes high uncertainties. Therefore the Hausen correlation [19] was considered in presented paper. This correlation was chosen due to the most suitable Reynolds number range, it means 2300-6000. The Hausen correlation for rectangular channel is described by following equation:

$$Nu_w = 0.116 \left(Re_{w_1ch}^{2/3} - 160 \right) Pr_w^{1/3} \left[1 + \left(\frac{D_H}{L} \right)^{2/3} \right] \left(\frac{\mu}{\mu_{wall}} \right)^{0.11}, \quad (4)$$

where Re_{w_1ch} is the one channel Reynolds number for water flow, Pr_w is the Prandtl number for water, D_H is the hydraulic diameter of one minichannel, L is the minichannel length, μ is the dynamic viscosity at water temperature, while μ_{wall} is the dynamic viscosity at wall temperature.

The necessary physical and thermal properties were taken from [16] for the water average temperature. The calculated values of Nusselt number for one water channel Reynolds number are presented in figure 14. They are followed by the calculated values of heat transfer coefficient on water side of minichannels PHE shown in figure 15. Both figures are shown to indicate numerical values representing heat transfer enhancement and main parameter causing it.

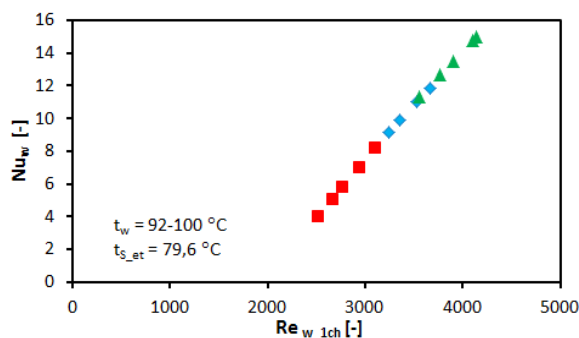

Figure 14. Nusselt number versus the water flow Reynolds number for one minichannel.

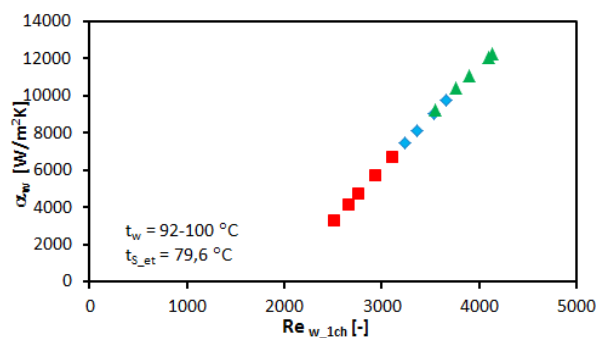

Figure 15. Heat transfer coefficient on heat exchanger water side versus the water flow Reynolds number for one minichannel.

The heat transfer coefficient on ethanol side of analyzed heat exchanger was calculated in the basis of equation (3), which took following form:

$$\alpha_{et} = \left(\frac{1}{k} - \frac{\delta}{\lambda} - \frac{1}{\alpha_w} \right)^{-1} \quad (5)$$

and the results are presented in figures 16 and 17.

Figure 16 shows the heat transfer coefficient on heat exchanger ethanol side as the function of heat flux, while figure 17 as the function of the ethanol vapour quality. The maximal obtained value of heat transfer coefficient for ethanol side was about 7500 W/m²K, while for water side 12000 W/m²K. The difference in the mass fluxes should be emphasized here. Mass flux of ethanol was about 13 times smaller than water one, but significant heat transfer enhancement on ethanol side was caused by the boiling process.

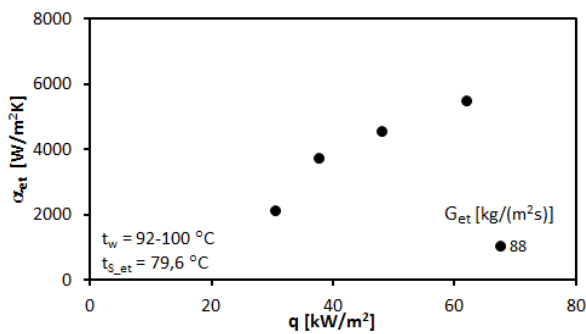

Figure 16. Heat transfer coefficient on heat exchanger ethanol side versus the heat flux.

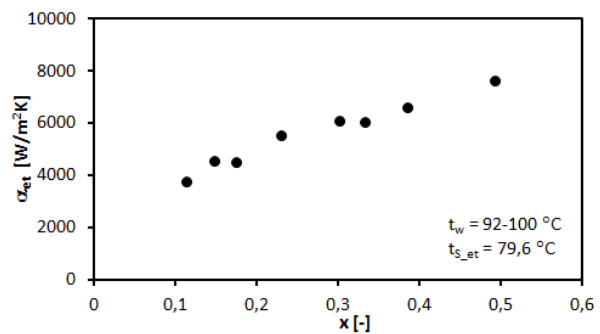

Figure 17. Heat transfer coefficient on heat exchanger ethanol side versus the ethanol vapour quality.

6. Uncertainties

The uncertainty analysis of presented experimental investigations was done in systematic manner. Taking into account low number of measurements repetition, but also high repeatability of data, the statistic uncertainties were not considered. The analysis presented in this paper, concentrated on the systematic error analysis. The analysis was based on the principle of uncertainties propagation described by the formula [20]:

$$\Delta y = \sqrt{\left(\frac{\partial f}{\partial x_1} \Delta x_1\right)^2 + \left(\frac{\partial f}{\partial x_2} \Delta x_2\right)^2 + \left(\frac{\partial f}{\partial x_3} \Delta x_3\right)^2 + \dots} \quad (6)$$

where Δx is the maximal uncertainty of measuring instrument. The uncertainty of analyzed functions depended on the particular variables uncertainties. In presented case the uncertainties were connected with direct measurements, indirect calculations and withdrawal from the tables (thermo-physical properties). The applied uncertainties of various devices used in experiment were described in the section discussing the experimental facility and procedure.

The results of uncertainty analysis are summarized in Table 1. The relative uncertainty was calculated in the basis of following equation:

$$\delta y = \frac{\Delta y}{y} \cdot 100\% \quad (7)$$

7. Summary and conclusions

The experimental analysis of prototype minichannels plate heat exchanger under ethanol boiling conditions was described. The determination of thermal performance was the main purpose of this work therefore the thermal characteristics of investigated unit were presented. Maximal value of heat transfer rate was at the level of 0.75 kW for 1360 kg/(m²s) of water mass flux and 47 kg/(m²s) of ethanol one. It should be pointed out, that it was obtained for the heat transfer area of about 0.009 m² and additional significant rise of hydraulic resistance. The hydraulic resistance increase was coming from the initiated ethanol boiling process and caused the pressure drop.

Table 1. Summary of the uncertainty analysis

Parameter	Relative value [%]
mass flux	3.4-3.8
overall heat transfer coefficient	4.7-9.0
convective heat transfer coefficient (water)	6.1-9.7
convective heat transfer coefficient (ethanol)	8.4-11.7
heat rate	4.7-9.0
heat flux	4.7-9.1
Reynolds number	3.7-4.1
Nusselt number	6.0-9.6

In the consequence the delivery of ethanol pump decreased. When the ethanol volume flow rate was smaller the boiling was intensified and the ethanol vapour quality increased (this chain of processes led to the result presented in figures 6 and 7). The highest value of overall heat transfer coefficient was about 4200 W/(m²K) and transferred heat flux was about 84 kW/m². Presented values of heat transfer coefficient for the ethanol in boiling state (up to 6 kW/(m²K) at the heat flux of 62 kW/m², figure 16) are confirmed by the fundamental investigations of ethanol boiling in the minichannels [21].

In the authors opinion proposed construction of minichannel plate heat exchanger is promising in the light of future cogeneration ORC systems applications. However further systematic analysis should be conducted to clarify the influence of media mass flow rates on the heat transfer coefficients and following on the heat exchanger performance.

8. References

- [1] Webb R L 1994 *Principles of enhanced heat transfer* (New York: Wiley-Interscience)
- [2] Bergles A E 2002 ExHFT for fourth generation heat transfer technology *Experimental Thermal and Fluid Science* **26** 335-44
- [3] Thome J 1990 *Enhanced boiling heat transfer* (New York: Hemisphere Publishing Corp.)
- [4] Webb R L 2004 Odyssey of the enhanced boiling surface *ASME J. Heat Transfer* **126** 1051-9
- [5] Wu Z and Sunden B 2014 On further enhancement of single-phase and flow boiling heat transfer in micro/minichannels *Renewable and Sustainable Energy Reviews* **40** 11-27
- [6] Gupta A and Uniyal M 2012 Review of heat transfer augmentation through different passive intensifier methods, *IOSR J. Mech. Civ. Eng.* **1** 14-21
- [7] Stone K M 1996 Review of literature on heat transfer enhancement in compact heat exchangers *Air Conditioning and Refrigeration Center Technical Reports* University of Illinois
- [8] Li Q, Flamant G, Yuan X, Neveu P and Luo L 2011 Compact heat exchangers: A review and future applications for a new generation of high temperature solar receivers *Renewable and Sustainable Energy Reviews* **15** 4855-75
- [9] CorHex producer data 2013, www.corhex.com
- [10] Plata M 2009 *World patent* WO 2009095896 20090806
- [11] Wajs J and Mikielwicz D 2016 Influence of metallic porous microlayer on pressure drop and heat transfer of stainless steel plate heat exchanger *Appl. Therm. Eng.* **93** 1337-46
- [12] Wajs J and Mikielwicz D 2014 Effect of surface roughness on thermal-hydraulic characteristics of plate heat exchanger *Key Engineering Materials* **597** 63-74
- [13] Mikielwicz D, Wajs J, Mikielwicz J and Jaskólski M 2012 Methods of heat transfer intensification in application to mini and micro heat exchangers. *Proc. of the 7th International Symposium on Turbulence, Heat and Mass Transfer* (Italy, Palermo) 10.1615/ICHMT.2012.ProcSevIntSympTurbHeatTransfPal.1430
- [14] Wajs J, Mikielwicz D, Fornalik-Wajs E and Bajor M 2015 Recuperator with microjet technology as a proposal for heat recovery from low-temperature sources *Archives of Thermodynamics* **36** (4) 49-64

- [15] Mikielwicz D, Muszyński T and Wajs J 2012 New concept of minichannel plate heat exchanger and its preliminary thermal-hydraulic investigations *Institute of Fluid-Flow Machinery Polish Academy of Sciences report* No. 204
- [16] Refprop v.9.0 National Institute of Standards
- [17] Wilson E E 1915 A basis for rational design of heat transfer apparatus *Trans. ASME* **37** 47-82
- [18] Adams T M, Abdel-Khalik S I, Jeter SM and Qureshi Z H 1998 An experimental investigation of single-phase forced convection in microchannels *Int. J. Heat Mass Tran.* **41** 851-7
- [19] Wang C, Gao P, Tan S and Wang Z 2013 Forced convection heat transfer and flow characteristics in laminar to turbulent transition region in rectangular channel *Experimental Thermal and Fluid Science* **44** 490-7
- [20] Moffat R J 1988 Describing the uncertainties in experimental results *Exp. Therm. Fluid Sci.* **1** 3-17
- [21] Zrooga A-B S R 2010 *Experimental and theoretical study of boiling and dryout phenomenon of ethanol in vertical minitubes* (Gdansk University of Technology: Ph.D. thesis)