



PAPER • OPEN ACCESS

## Towards a classification of networks with asymmetric inputs

To cite this article: Manuela Aguiar *et al* 2021 *Nonlinearity* **34** 5630

View the [article online](#) for updates and enhancements.

# Towards a classification of networks with asymmetric inputs

Manuela Aguiar<sup>1,4</sup> , Ana Dias<sup>2,4</sup>  and Pedro Soares<sup>3,4,\*</sup> 

<sup>1</sup> Faculdade de Economia, Centro de Matemática, Universidade do Porto, Rua Dr Roberto Frias, 4200-464 Porto, Portugal

<sup>2</sup> Departamento de Matemática, Centro de Matemática, Universidade do Porto, Rua do Campo Alegre, 687, 4169-007 Porto, Portugal

<sup>3</sup> Faculty of Applied Physics and Mathematics, Gdańsk University of Technology, Narutowicza 11/12, 80-233 Gdańsk, Poland

<sup>4</sup> Centro de Matemática, Universidade do Porto, Rua do Campo Alegre, 687, 4169-007 Porto, Portugal

E-mail: [maguiar@fep.up.pt](mailto:maguiar@fep.up.pt), [apdias@fc.up.pt](mailto:apdias@fc.up.pt) and [psoares@iseg.ulisboa.pt](mailto:psoares@iseg.ulisboa.pt)

Received 23 December 2019, revised 4 February 2021

Accepted for publication 14 June 2021

Published 6 July 2021



CrossMark

## Abstract

Coupled cell systems associated with a coupled cell network are determined by (smooth) vector fields that are consistent with the network structure. Here, we follow the formalisms of Stewart *et al* (2003 *SIAM J. Appl. Dyn. Syst.* **2** 609–646), Golubitsky *et al* (2005 *SIAM J. Appl. Dyn. Syst.* **4** 78–100) and Field (2004 *Dyn. Syst.* **19** 217–243). It is known that two non-isomorphic  $n$ -cell coupled networks can determine the same sets of vector fields—these networks are said to be ordinary differential equation (ODE)-equivalent. The set of all  $n$ -cell coupled networks is so partitioned into classes of ODE-equivalent networks. With no further restrictions, the number of ODE-classes is not finite and each class has an infinite number of networks. Inside each ODE-class we can find a finite subclass of networks that minimize the number of edges in the class, called minimal networks. In this paper, we consider coupled cell networks with asymmetric inputs. That is, if  $k$  is the number of distinct edges types, these networks have the property that every cell receives  $k$  inputs, one of each type. Fixing the number  $n$  of cells, we prove that: the number of ODE-classes is finite; restricting to a maximum of  $n(n - 1)$  inputs, we can cover all the ODE-classes; all minimal  $n$ -cell networks with  $n(n - 1)$  asymmetric inputs are ODE-equivalent.

\* Author to whom any correspondence should be addressed.

Recommended by Dr Hinke M Osinga.



Original content from this work may be used under the terms of the [Creative Commons Attribution 3.0 licence](https://creativecommons.org/licenses/by/3.0/). Any further distribution of this work must maintain attribution to the author(s) and the title of the work, journal citation and DOI.



We also give a simple criterion to test if a network is minimal and we conjecture lower estimates for the number of distinct ODE-classes of  $n$ -cell networks with any number  $k$  of asymmetric inputs. Moreover, we present a full list of representatives of the ODE-classes of networks with three cells and two asymmetric inputs.

Keywords: coupled cell network, asymmetric inputs, minimal network, network ODE-class

Mathematics Subject Classification numbers: Primary: 34C20, 05C90, 05C30, Secondary: 15A36.

## 1. Introduction

In this paper, we consider (*coupled cell*) networks as formalized by Stewart *et al* [28], Golubitsky *et al* [16] and Field [15]. A network is a directed graph together with label types on cells and edges (couplings). Any such directed graph can be represented by a set of adjacency matrices, one for each edge type. Note that the number of networks grows exponentially with the number of cells and the number of edges. Each network, schematically, represents a set of dynamical systems (the cells) and their dependencies (the couplings). We consider that each cell represents a system of ordinary differential equations (ODEs) where multi-couplings and auto-couplings (self-loops) are allowed. A collection of ODE's for the different cells of a network that respects the network topology is a *coupled cell system* associated with that network.

The main motivation for our work is the fact that it is possible to partition the set of networks into classes according to the different types of dynamics they can support. More concretely, in [16], Golubitsky *et al* remark that some non-isomorphic networks support exactly the same coupled cell systems. Those networks are said to be *ODE-equivalent*. From the modeling point of view, this implies that some dynamics can be modeled in more than one way, and that the set of dynamics is smaller than the set of networks. Dias and Stewart [14] show that two networks are ODE-equivalent if and only if they are *linearly equivalent*, i.e., the real linear subspaces generated by the adjacency matrices of each network coincide, for some cell renumbering. In [8] Aguiar and Dias introduce *minimal* networks as the networks with the minimal number of edges among the networks in an *ODE-class* (a set of all ODE-equivalent networks to a given network). They also provide an algorithm to obtain the minimal networks of a given ODE-class.

In this work we consider *networks with  $k$  asymmetric inputs*—networks with  $k$  coupling types and where each cell receives exactly one input of each type—and provide methods towards their ODE-classification. In particular, we get that classification through the determination of the minimal representatives for the ODE-equivalence classes. Networks with asymmetric inputs are *homogeneous*—there is only one cell type and every cell receives exactly the same number of inputs. The term asymmetric is used to refer that the inputs to a given cell are of different type and not that the types of cells are different. In recent years a number of works on networks with asymmetric inputs have given a major contribution to the study of the dynamics and bifurcations of such networks. For example, it is proved by Aguiar *et al* [4] that these networks can support robust heteroclinic cycles, even in low dimension. The synchrony lattice of networks with asymmetric inputs is studied by Aguiar [3]. Bifurcation problems have been considered by Rink and Sanders [24, 25], Nijholt *et al* [19–21] and Aguiar *et al* [9].

Towards the classification of networks with asymmetric inputs, and considering the above, we achieve the following:

- (a) We give an enumeration of the minimal three-cell networks with one and two asymmetric inputs, up to ODE-equivalence.

- (b) We prove that a minimal  $n$ -cell network has at most  $n(n - 1)$  asymmetric inputs and that there is only one ODE-class of  $n$ -cell networks with  $n(n - 1)$  asymmetric inputs.
- (c) We show that a representative minimal  $n$ -cell network with  $n(n - 1)$  inputs can be obtained combining  $n(n - 1)$  feed-forward networks with one input.
- (d) We give two methods for the explicit construction of  $n(n - 1)$  ODE-distinct minimal  $n$ -cell networks with one input.

Concerning (a), the list of the six ODE-distinct minimal three-cell networks with one input was obtained by Leite and Golubitsky [17]. Here, we provide the complete list of the 48 ODE-distinct minimal networks with three cells and two inputs (theorem 5.2 and tables 3–6). In particular, this list contains the ten ODE-classes of strongly connected networks, with three cells, two asymmetric inputs and one or two two-dimensional synchrony subspaces, considered in Aguiar et al [4] and the seven networks with a monoid symmetry with three elements given by Rink and Sanders [24]. The networks with a monoid symmetry are called *fundamental networks*. Surprisingly, two of the ODE-distinct three cell networks have the same monoid symmetry with three elements (remark 5.7). The enumeration of the ODE-distinct three-cell networks with two inputs already illustrates the complexity in the ODE-classification of networks.

In view of the large number of possible networks, different authors have focused their attention on networks with a low number of cells and inputs. These small networks can be viewed as building blocks of complex networks which are usually called *motifs* [18]. Small networks also appear as quotient networks when considering the restriction of coupled cell systems to synchrony subspaces. The study of the dynamics of smaller networks is not only feasible but can also contribute to the understanding of the dynamics of bigger networks. When the synchrony pattern has three or less distinct synchronies, we end up with a network with three or fewer cells. Therefore, the study of the networks with three cells or fewer, allow us to understand any pattern with three or less distinct synchronies. In a follow-up work, we study the steady-state bifurcation problems of the 48 networks listed here [10].

In (b), we prove that the maximum number of asymmetric inputs in a minimal network with  $n$  cells is  $n(n - 1)$  (theorem 6.3). Thus any  $n$ -cell network is ODE-equivalent to an  $n$ -cell network with at most  $n(n - 1)$  inputs. That is, there is a finite number of ODE-distinct networks with asymmetric inputs, for a fixed number of cells. So, we can repeat the method presented in section 5 for three cell networks and enumerate all ODE-distinct minimal  $n$ -cell networks with  $k$  asymmetric inputs, where  $k$  runs from 1 to  $n(n - 1)$ . Alternatively, we can start with a list of every network with  $n(n - 1)$  asymmetric inputs and then reduce it to a list of minimal representative networks. This contrasts with the case of minimal homogeneous networks with one type of symmetric inputs where there is no bound on the number of inputs. See, for example, Aldosray and Stewart [11] for the enumeration of homogeneous networks with symmetric inputs and an arbitrary number of inputs. Furthermore, we remark that all minimal networks of  $n$ -cells with  $n(n - 1)$  asymmetric inputs are ODE-equivalent (corollary 6.4).

In (c), we present a minimal  $n$ -cell network with  $n(n - 1)$  asymmetric inputs (theorem 7.5). Surprisingly, this representative is given by the union of  $n(n - 1)$  one-input feed-forward networks. *Feed-forward networks* are those where cells arranged in layers and such that the information moves only in one direction, forward, from the input nodes (first layer), through the hidden nodes (middle layers), and to the output nodes (last layer). Moreover some of these  $n(n - 1)$  feed-forward networks given the minimal representative are ODE-equivalent. However, for the three cells case, we see that we can use six ODE-distinct three-cell networks to obtain a minimal network with three cells and six asymmetric inputs (example 6.2). We

note that feed-forward networks have been addressed by different authors, see for example [5, 6, 20, 22, 23, 26, 27].

Finally, in (d), we prove that the set of minimal networks with  $n$  cells and one input contains, at least,  $n(n - 1)$  ODE-distinct networks (theorem 8.7). In fact, we provide algorithms to construct these ODE-distinct minimal networks using networks with fewer cells.

The manuscript is organized as follows. Sections 2 and 3 recall some definitions and known results about coupled cell networks and coupled cell systems. In section 4, we give a criterion for minimal networks with asymmetric inputs using the known fact that two networks are ODE-equivalent if and only if they are linear equivalent. Section 5 contains the classification of the three-cell networks with two asymmetric inputs. In section 6, we prove that a minimal network with  $n$  cells has at most  $n(n - 1)$  asymmetric inputs. In section 7, a minimal  $n$ -cell networks with  $n(n - 1)$  asymmetric inputs is given by the union of  $n(n - 1)$  feed-forward networks. In section 8, we describe two algorithms to obtain ODE-distinct minimal  $n$ -cell networks with one input using smaller networks. Section 9 includes some final conclusions where, in particular, we present two conjectures about the number of minimal networks.

## 2. Preliminary definitions

In this section, we recall a few definitions and results concerning coupled cell networks, coupled cell systems and ODE-equivalence of networks. We follow the coupled cell network formalism of Stewart et al [28] and Golubitsky et al [16].

**Definition 2.1.** A (*coupled cell*) network  $G$  consists of a finite non-empty set  $C$  of *cells* and a finite non-empty set  $E = \{(c, d) : c, d \in C\}$  of *edges*. Each pair  $(c, d) \in E$  represents an edge from cell  $d$  to cell  $c$  and the cells  $c, d$  are called, respectively, the *head* and *tail* cell. Cells and edges can be of different types.

A network can be represented by a directed unweighted graph, where the nodes represent the cells and the edges are depicted by directed arrows. Different types of cells and edges are indicated in the graph, respectively, by different shapes of nodes and different edge arrowheads.

**Definition 2.2.** A network is said to be *homogeneous* if the cells have all the same type, that is, they are *identical*, and receive the same number of input edges per edge type. The *valency* is the number of inputs that each cell receives.

**Definition 2.3.** A *network with one input* is an homogeneous network with one edge type where each cell receives exactly one edge of that type. A *network with  $k$  asymmetric inputs*, for an integer  $k > 1$ , is an homogeneous network with  $k$  edge types where each cell receives exactly one edge of each type.

**Example 2.4.** In figure 1, we present three-cell networks with one and two asymmetric inputs.

**Definition 2.5.** Given a network with set of cells  $C$ , we say there is a *directed path* connecting a sequence of cells  $(c_0, c_1, \dots, c_{k-1}, c_k)$  of  $C$ , if there is an edge from  $c_{j-1}$  to  $c_j$ , for  $j \in \{1, \dots, k\}$ . If, for every  $j \in \{1, \dots, k\}$ , there is an edge from  $c_{j-1}$  to  $c_j$  or from  $c_j$  to  $c_{j-1}$ , we say that there is an *undirected path* connecting the sequence of cells  $(c_0, c_1, \dots, c_{k-1}, c_k)$ . A network is *connected* if there is an undirected path between any two cells. And a network is *strongly connected* if there is a directed path from  $c$  to  $d$  for every pair of cells  $(c, d) \in C \times C$ .

The coupling structure of a network with set of cells  $C = \{1, \dots, n\}$  and  $k$  edge types can be described through  $k$  *adjacency matrices*  $A_l := (a_{ij}^{(l)}) \in M_{n,n}(\mathbb{R})$ , with rows and columns indexed

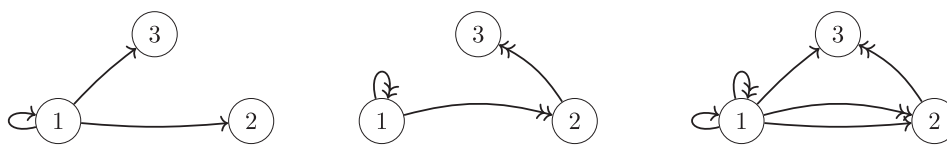

**Figure 1.** Networks with three cells and asymmetric inputs: in the left and the middle networks every cell receives one input; in the right network every cell receives two asymmetric inputs of the same type.

by the cells in  $C$  and  $1 \leq l \leq k$ . Each entry  $a_{ij}^{(l)}$  corresponds to the number of edges of type  $l$  from cell  $j$  to cell  $i$ . If the network has asymmetric inputs then its adjacency matrices have valency one, i.e., the entries are 0 or 1 and the row-sum is equal to one.

**Example 2.6.** The three-cell network on the right in figure 1 has two asymmetric inputs. Its coupling structure can be represented by the following two  $3 \times 3$  adjacency matrices (corresponding, respectively, to the adjacency matrices of the networks on the left and the middle of figure 1):

$$A_1 = \begin{pmatrix} 1 & 0 & 0 \\ 1 & 0 & 0 \\ 1 & 0 & 0 \end{pmatrix}, \quad A_2 = \begin{pmatrix} 1 & 0 & 0 \\ 1 & 0 & 0 \\ 0 & 1 & 0 \end{pmatrix}.$$

According to the definition of union of graphs, we have the following definition for the union of two networks with the same set of cells but having different edge types.

**Definition 2.7.** Given  $k$  networks  $G_i$  with the same set of cells  $C$ , and sets of edges  $E_i$ , for  $i = 1, \dots, k$ , we define the *union network*  $G_1 \cup \dots \cup G_k$ , to be the network with set of cells  $C$  and set of edges to be the disjoint union  $E_1 \cup \dots \cup E_k$ . The set of adjacency matrices of the union network is the disjoint union of the corresponding sets of adjacency matrices.

**Example 2.8.** A network with  $k$  asymmetric inputs is the union of  $k$  networks with one input. The network on the right of figure 1 is the union of the networks on the middle and the left.

*Feed-forward* and *n-cycle* are relevant examples among the networks with one input.

**Definition 2.9.** Let  $N$  be a connected network with  $n$  cells and one input.

- (a) The network  $N$  is an *n-cycle* if there is the directed path  $(1, 2, \dots, n, 1)$ , up to a reordering of cells.
- (b) The network  $N$  is a *feed-forward* network, if we can renumber the cells such that, for every edge  $(i, j) \in E$ , we have  $i < j$  or  $i = j = 1$ . In this case, a cell with a self-loop is a *root* and a *tail* with length  $k$  is a directed path with  $k$  connections from a root cell to a cell with no outgoing connections.

**Example 2.10.** The networks on the left and middle of figure 1 are feed-forward with one input. The network on the left has two tails with length one and the network on the middle has one tail with length two.



### 2.1. Coupled cell systems

Let  $G$  be an  $n$ -cell network with  $k$  asymmetric inputs, say of types  $1, \dots, k$ . Following [16, 28], we take a cell to be a system of ODEs and we consider the class of coupled cell systems that have structure consistent with the network  $G$ . All the cells have the same phase space, say  $V = \mathbb{R}^m$  for some  $m > 0$ , the same internal dynamics and, for each cell  $i$ , the dynamics is governed by the same smooth function  $f$ , evaluated at the starting cells of the edges targeting that cell. Thus, for  $i = 1, \dots, n$ , we have that the evolution of cell  $i$  is given by the set of ODEs

$$\dot{x}_i = f(x_i; x_{i_1}, \dots, x_{i_k}), \quad (2.1)$$

if the input set of cell  $i$  is  $\{i_1, \dots, i_k\}$ , where  $i_j$  is the tail cell of the edge with type  $j$  and head cell  $i$ . The function  $f: V^{k+1} \rightarrow V$  is assumed to be smooth. We say that coupled cell systems with cells governed by equations of the form (2.1) are  $G$ -admissible.

**Example 2.11.** Consider the networks on the left and the right of figure 1. Coupled cell systems with structure consistent with these, have the following form, respectively:

$$\begin{cases} \dot{x}_1 = f(x_1; x_1) \\ \dot{x}_2 = f(x_2; x_1) \\ \dot{x}_3 = f(x_3; x_1) \end{cases} \quad \begin{cases} \dot{x}_1 = g(x_1; x_1; x_1) \\ \dot{x}_2 = g(x_2; x_1; x_1) \\ \dot{x}_3 = g(x_3; x_1; x_2) \end{cases}$$

for any smooth functions  $f: (\mathbb{R}^m)^2 \rightarrow \mathbb{R}^m$  and  $g: (\mathbb{R}^m)^3 \rightarrow \mathbb{R}^m$ , if cell phase spaces are chosen to be  $\mathbb{R}^m$ .

### 2.2. Network synchrony subspaces

A network *synchrony subspace*  $\Delta$  is a subspace of the network total phase space defined by certain equalities of cell coordinates (a polydiagonal subspace) which is left invariant under the flow of every network admissible coupled cell system. In that case, if  $x_i = x_j$  is one of the cell coordinates defining  $\Delta$ , then a solution of any system given by (2.1) with initial condition in  $\Delta$  have cells  $i, j$  synchronized (i.e.,  $x_i(t) = x_j(t)$ ) for all time  $t$ . One of the consequences of theorem 6.5 of [28] is that a polydiagonal space  $\Delta$  is a synchrony subspace if and only if it is left invariant under the network adjacency matrices. So, a polydiagonal space is a synchrony subspace for a union network if and only if it is a synchrony subspace for each network.

**Example 2.12.** Consider the networks of figure 1. The diagonal space defined by  $x_1 = x_2 = x_3$  is a synchrony subspace for the three networks. In fact, any polydiagonal is a synchrony subspace for the network on the left and the subspace defined by  $x_1 = x_2$  is a synchrony subspace for the middle network. Thus that subspace,  $x_1 = x_2$ , is a synchrony subspace for the network in the right.

## 3. ODE-equivalence of networks

It was noted in [28] that different networks with the same number of cells can have the same set of admissible equations for any choice of cell phase spaces. As an example of that, consider the two networks in figure 2. Note that the corresponding coupled cell systems with structure





**Figure 2.** Two networks with three cells and asymmetric inputs that are ODE-equivalent. On the left network, every cell receives one input. On the right network, every cell receives two asymmetric inputs.

consistent with these, have the following form, respectively:

$$\begin{cases} \dot{x}_1 = f(x_1; x_1) \\ \dot{x}_2 = f(x_2; x_1) \\ \dot{x}_3 = f(x_3; x_1) \end{cases} \qquad \begin{cases} \dot{x}_1 = g(x_1; x_1; x_1) \\ \dot{x}_2 = g(x_2; x_1; x_1) \\ \dot{x}_3 = g(x_3; x_1; x_1) \end{cases}$$

for any smooth functions  $f : (\mathbb{R}^m)^2 \rightarrow \mathbb{R}^m$  and  $g : (\mathbb{R}^m)^3 \rightarrow \mathbb{R}^m$ , if cell phase spaces are chosen to be  $\mathbb{R}^m$ . Trivially, given  $f$  we can define  $g$  in the following form:  $g(x, y, z) = f(x, y)$ . Also, given  $g$ , we can define  $f$  such that  $f(x, y) = g(x, y, y)$ . Thus, we have two networks where the associated sets of vector fields coincide.

The next definition corresponds to definitions 5.1 and 6.2 in [14]. There is also the more combinatorial approach presented by Agarwal and Field [1, 2].

**Definition 3.1.** [14] Two  $n$ -cell networks  $G_1$  and  $G_2$  are *ODE-equivalent* when there is a bijection map between their sets of cells such that, for any choice of their cells phase spaces preserving this bijection between the sets of cells, they define the same set of admissible coupled cell systems. If this holds for the set of linear admissible coupled cell systems, then  $G_1$  and  $G_2$  are said to be *linearly equivalent*.

Re-enumerating the cells of  $G_1$  (or  $G_2$ ), we can consider that the bijection between the set of cells in the previous definition is the identity. The following theorem, which corresponds to theorem 7.1 and corollary 7.9 of [14], relates the two concepts of ODE-equivalence and linear equivalence on networks:

**Theorem 3.2.** [14] *Two  $n$ -cell networks  $G_1$  and  $G_2$  are ODE-equivalent if and only if they are linearly equivalent when the cell phase spaces are  $\mathbb{R}$ .*

It follows from the previous result a more practical definition of ODE-equivalence. Two  $n$ -cell networks,  $G_1$  and  $G_2$ , are ODE-equivalent if and only if there exists a re-enumeration of the cells such that the two linear subspaces of  $M_{n \times n}(\mathbb{R})$  generated by  $\text{Id}_n, A_1, \dots, A_{k_1}$  and  $\text{Id}_n, B_1, \dots, B_{k_2}$  coincide, where  $A_1, \dots, A_{k_1}$  and  $B_1, \dots, B_{k_2}$  are the adjacency matrices, after re-enumeration, of  $G_1$  and  $G_2$ , respectively.

**Example 3.3.** In figure 2, note that the network on the right has two edge types represented by the same adjacency matrix. Trivially, using the linear equivalence criterion, the two networks in figure 2 are ODE-equivalent.



#### 4. Criterion for minimality of networks with asymmetric inputs

Fixing the number  $n$  of cells, and given an  $n$ -cell network  $G$ , the ODE-class of  $G$ , denoted by  $[G]$ , is the set of all  $n$ -cell networks that are ODE-equivalent to  $G$ , which is in general non-finite. In Aguiar and Dias [8], it was introduced the notion of *minimal networks* of an ODE-class of a network  $G$ , which are the networks with the minimal number of edges among the networks in the set  $[G]$ .

**Example 4.1.** As noted above, the two networks in figure 2 are ODE-equivalent. We see that each cell in the network on the left receives a unique input. It follows that this network is minimal. In fact, from proposition 5.11 of Aguiar and Dias [8], we have that, up to permutation of the cells, the network on the left is the unique minimal network in the ODE-class of both networks of figure 2.

In [8], it was proved that, in general, fixing a network ODE-class, there are several networks which are minimal. Moreover, it was obtained a method to describe all the minimal networks of the class—that method, is precisely obtained making use of theorem 3.2. We are interested in networks with asymmetric inputs that are minimal. The next result follows from proposition 5.11 in [8].

**Proposition 4.2.** [8] *Let  $G$  be an  $n$ -cell network with  $m$  asymmetric inputs where  $A_1, \dots, A_m$  are the associated adjacency matrices. The network  $G$  is minimal if and only if the  $m + 1$  matrices  $\text{Id}_n, A_1, \dots, A_m$  are linearly independent.*

Let  $\text{Min}_{m,n}$  denote the set of minimal  $n$ -cell networks with  $m$  asymmetric inputs.

##### 4.1. Minimal $n$ -cell networks with one input

Consider that  $G$  is an  $n$ -cell network with one input and adjacency matrix  $A$  such that  $A \neq \text{Id}_n$ . Trivially, we have that  $\text{Id}_n$  and  $A$  are linearly independent. Thus, a direct consequence of proposition 4.2 is that  $G \in \text{Min}_{1,n}$ . Moreover, two networks in  $\text{Min}_{1,n}$  are ODE-distinct (not ODE-equivalent) unless there is a re-enumeration of the cells such that the two networks are the same. The next result states this and it also follows from proposition 5.11 and theorem 9.3 of [8].

**Proposition 4.3.** *Let  $G_1$  and  $G_2$  be two minimal  $n$ -cell networks with one input and adjacency matrices  $A_i \neq \text{Id}_n$ , for  $i = 1, 2$ . Then  $[G_1] = [G_2]$  if and only if  $G_1$  and  $G_2$  are equal up to permutation of cells. Equivalently,  $[G_1] = [G_2]$  if and only if it exists an  $n \times n$  permutation matrix  $P$  such that  $A_1 = PA_2P^{-1}$ .*

The number of networks with one input, up to permutation of cells, is given by theorem 8.3 of Aldosray and Stewart [11]. Roughly speaking, the number of networks with  $n$  cells and one input, up to permutation of cells, is equal to

$$\frac{1}{n!} \sum_{p=(p_1, \dots, p_n) \in P_n} C_p \prod_{k=1}^n \phi(k, p)^{p_k},$$

where  $P_n$  is the set of partitions of  $n$  and  $(p_1, \dots, p_n) \in P_n$  if  $p_1 + \dots + np_n = n$ ,  $C_p$  is the number of permutations having a cycle partition equal to  $p$  and  $\phi(k, p)$  is the number of possible ways to fill the row  $p_1 + \dots + (k-1)p_{k-1} + 1$  of an adjacency matrix compatible with the partition  $p$  and row sum equal to one. Aldosray and Stewart calculated this number for  $n \leq 6$  and obtained that there are 1, 3, 7, 19, 47 and 130 networks with one input and 1, 2, 3, 4, 5 and 6 cells, respectively. See [11] for details. With the exception of the network with adjacency matrix

given by the identity, the networks with one input are minimal and ODE-distinct between them, up to permutation of cells. Thus, the number of ODE-distinct networks in  $\text{Min}_{1,n}$  is 1, 2, 6, 18, 46 and 129 for  $n = 1, \dots, 6$ , respectively.

#### 4.2. Minimal $n$ -cell networks with two asymmetric inputs

For the particular case of a network  $G$  with two asymmetric inputs, the result in proposition 4.2 states that  $G$  is minimal if and only if the adjacency matrices  $A_1$  and  $A_2$  of  $G$  and the identity matrix (of the same dimension) are linearly independent. We get then the following corollary of proposition 4.2:

**Corollary 4.4.** *A network  $G$  with two asymmetric inputs given by the valency one adjacency matrices  $A_i \neq \text{Id}_n$ , for  $i = 1, 2$ , where  $A_1 \neq A_2$  is minimal.*

**Proof.** By proposition 4.2,  $G$  is not minimal if and only if the matrices  $\text{Id}_n, A_1, A_2$  are linearly dependent. As the matrices  $A_1$  and  $A_2$  have valency one and are not the identity matrix, then  $\text{Id}_n, A_1$  are linearly independent and  $\text{Id}_n, A_2$  are linearly independent. Thus if  $\text{Id}_n, A_1, A_2$  are linearly dependent, then there are nonzero real entries  $a, b, c$  such that

$$a\text{Id}_n + bA_1 + cA_2 = 0_{n \times n}.$$

Without loss of generality, we assume that  $A_2$  is a linear combination of  $\text{Id}_n$  and  $A_1$ . Thus, there are real numbers  $\alpha$  and  $\beta$  such that

$$A_2 = \alpha\text{Id}_n + \beta A_1.$$

As  $A_1 \neq \text{Id}_n$ , the matrices  $A_1$  and  $\text{Id}_n$  have at least one row  $i$  such that two entries differ and so, we can find  $j$  with  $j \neq i$  such that  $(A_1)_{ij} = 1$  and  $(A_1)_{ii} = 0$ . We obtain two linear equations: taking  $k_1 = (A_2)_{ij}$  and  $k_2 = (A_2)_{ii}$ ,

$$\begin{cases} (A_2)_{ij} = \alpha(\text{Id}_n)_{ij} + \beta(A_1)_{ij} \\ (A_2)_{ii} = \alpha(\text{Id}_n)_{ii} + \beta(A_1)_{ii} \end{cases} \Leftrightarrow \begin{cases} 0\alpha + 1\beta = k_1 \\ 1\alpha + 0\beta = k_2 \end{cases}.$$

Thus  $\beta = k_1 \in \{0, 1\}$  and  $\alpha = k_2 \in \{0, 1\}$ . Therefore we have one of the following cases  $A_2 = \text{Id}_n + A_1, A_2 = A_1, A_2 = \text{Id}_n$  or  $A_2 = 0$ . Since  $A_2$  has row-sum equal to 1 and it is different from  $A_1$  and  $\text{Id}_n$ , the previous cases are impossible. Thus  $\text{Id}_n, A_1, A_2$  are linearly independent and  $G$  is minimal.  $\square$

It follows from corollary 4.4 that an  $n$ -cell network with two asymmetric inputs is not minimal if and only if the two inputs are equal. In this case the network is ODE-equivalent to an  $n$ -cell network with one input.

#### 4.3. Minimal $n$ -cell networks with $k$ asymmetric inputs

By proposition 4.2 and theorem 3.2, it also follows that:

**Corollary 4.5.** *Let  $G$  be an  $n$ -cell network with  $k$  asymmetric inputs and adjacency matrices  $A_1, \dots, A_k$ . If  $p$  denotes the dimension of the linear space generated by  $\text{Id}_n$  and  $A_1, \dots, A_k$ , then  $G$  is ODE-equivalent to a minimal  $n$ -cell network with  $p - 1$  asymmetric inputs.*

**Remark 4.6.** Under the conditions of corollary 4.5, any set of  $p - 1$  adjacency matrices of  $G$ , say  $A_1, \dots, A_{p-1}$ , such that  $\text{Id}_n, A_1, \dots, A_{p-1}$  are linearly independent, define a minimal network with  $p - 1$  asymmetric inputs in the ODE-class  $[G]$ .

## 5. Classification of three-cell networks with two asymmetric inputs

Using the fact that a network with  $k$  asymmetric inputs is the union of  $k$  networks with one input, we have a way of enumerating networks with  $k$  asymmetric inputs using the enumeration of networks with one input. This list is large and the concept of minimality and ODE-equivalence of networks can be used to restrict this list. We illustrate this method with networks with three cells and two asymmetric inputs. That is, we obtain all the minimal three-cell connected networks with two asymmetric inputs, up to ODE-equivalence.

We start by classifying the three-cell minimal networks with one input.

### 5.1. Classification of three-cell networks with one input

We state and prove a well known classification of the ODE-classes of the minimal three-cell networks with one input. See, for example, Leite and Golubitsky [17]. We include this classification for completeness as it will be used in the next sections. We also include the two-dimension synchrony subspaces of those minimal representative networks.

**Lemma 5.1.** *There are only seven ODE-classes of three-cell networks with one input. One of these classes corresponds to the disconnected three-cell network, without edges. The other six classes are represented by the six minimal networks in table 1.*

**Proof.** Let  $G$  be a three-cell network with one input and adjacency matrix  $A \neq \text{Id}_3$ .

- If every cell of  $G$  sends some input then: either  $G$  is the three-cycle and it has no two-dimensional synchrony subspaces, see network  $A$  of table 1; or  $G$  has a cell  $i$  with a self-loop and a two-cycle and it has exactly one two-dimensional synchrony subspace,  $\Delta_i = \{x : x_j = x_k \text{ where } j, k \neq i\}$ , see network  $B$  of table 1. Moreover, there are no more two-dimensional synchrony subspaces since cell  $i$  cannot synchronize with only one of the two other cells.
- If two cells of  $G$  do not send any input to the other cells, then the third cell has to send all the three edges including a self-loop and  $G$  has three two-dimensional synchrony subspaces. Equivalently, every two cells can synchronize. See network  $C$  of table 1.
- If exactly one cell of  $G$  does not send any input to the other cells, then it must receive an edge from a second cell. If this second cell does not send another edge, then the third cell must send two edges including a self-loop. Thus, in this case  $G$  is the network  $D$  of table 1 and has exactly one two-dimensional synchrony subspace. If the second cell sends another edge, then the second and third cell must send each an edge between them. In this case, they can send self-loops corresponding to network  $E$  of table 1 or form a two-cycle corresponding to network  $F$  of table 1. Moreover, the networks  $E$  and  $F$  have exactly two two-dimensional synchrony subspaces.  $\square$

### 5.2. Classification of three-cell networks with two asymmetric inputs

We obtain now all the minimal three-cell connected networks with two asymmetric inputs, up to ODE-equivalence.

As stated before, every three-cell network with two asymmetric inputs is the union of two three-cell networks with one input. Since, in the union of two such networks, the order of the cells matters, we list in table 2 all the three-cell networks with one input and adjacency matrix  $A \neq \text{Id}_3$ , which are obtained from the networks in table 1 by permutation of the three cells.



5640

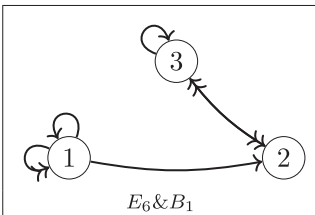
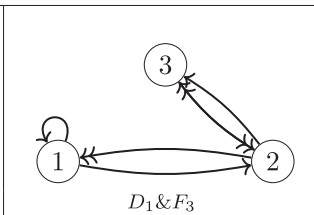
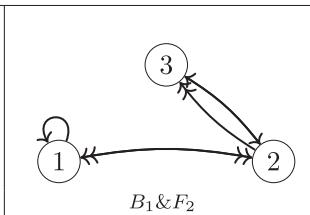
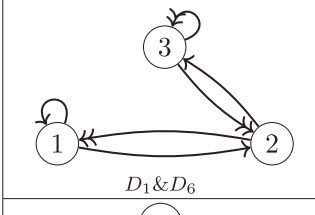
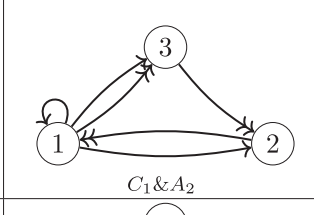
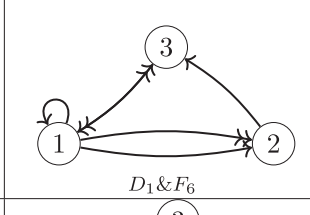
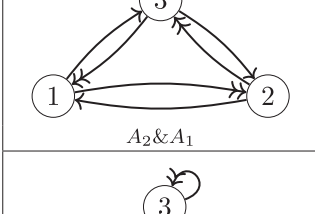
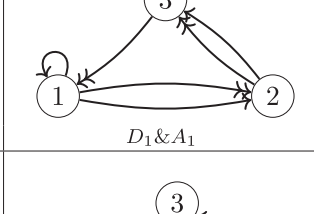
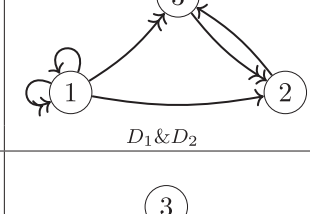
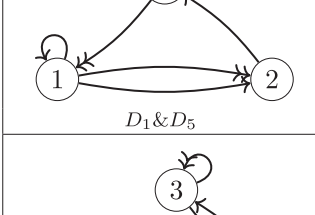
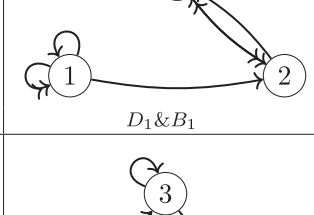
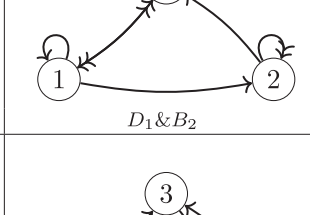
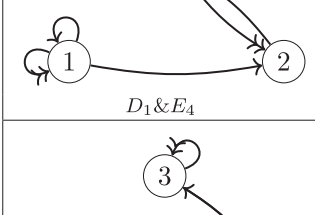
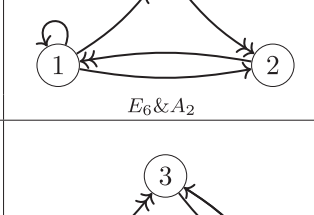
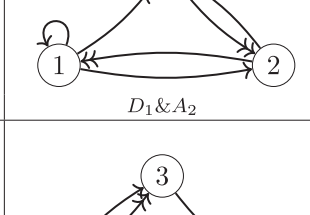
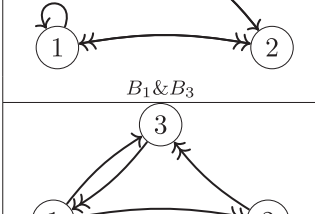
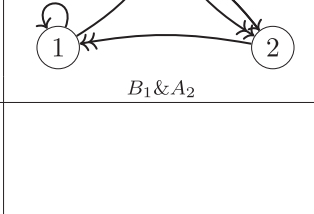
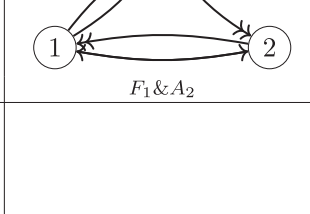

**Table 1.** Three-cell networks with one input and adjacency matrix  $A \neq Id_3$ , up to re-enumeration of the cells. Note that the networks  $C$  and  $D$  are feed-forward.

Network	2D synchrony subspaces	Adjacency matrix	Network	2D synchrony subspaces	Adjacency matrix
	—	$\begin{bmatrix} 0 & 0 & 1 \\ 1 & 0 & 0 \\ 0 & 1 & 0 \end{bmatrix}$		$\Delta_1$	$\begin{bmatrix} 1 & 0 & 0 \\ 0 & 0 & 1 \\ 0 & 1 & 0 \end{bmatrix}$
	$\Delta_1$ $\Delta_2$ $\Delta_3$	$\begin{bmatrix} 1 & 0 & 0 \\ 1 & 0 & 0 \\ 1 & 0 & 0 \end{bmatrix}$		$\Delta_3$	$\begin{bmatrix} 1 & 0 & 0 \\ 1 & 0 & 0 \\ 0 & 1 & 0 \end{bmatrix}$
	$\Delta_2$ $\Delta_3$	$\begin{bmatrix} 1 & 0 & 0 \\ 0 & 1 & 0 \\ 1 & 0 & 0 \end{bmatrix}$		$\Delta_1$ $\Delta_3$	$\begin{bmatrix} 0 & 1 & 0 \\ 1 & 0 & 0 \\ 1 & 0 & 0 \end{bmatrix}$

**Table 2.** Three-cell networks with one input obtained from the networks in table 1 by permutation of cells.

Network	2D syn subspace	Network	2D syn subspace	Network	2D syn subspace
	—		—		
	$\Delta_1$		$\Delta_2$		$\Delta_3$
	$\Delta_1$ $\Delta_2$ $\Delta_3$		$\Delta_1$ $\Delta_2$ $\Delta_3$		$\Delta_1$ $\Delta_2$ $\Delta_3$
	$\Delta_3$		$\Delta_2$		$\Delta_1$
	$\Delta_3$		$\Delta_2$		$\Delta_1$
	$\Delta_2$ $\Delta_3$		$\Delta_1$ $\Delta_2$		$\Delta_1$ $\Delta_3$
	$\Delta_1$ $\Delta_2$		$\Delta_1$ $\Delta_3$		$\Delta_2$ $\Delta_3$
	$\Delta_1$ $\Delta_3$		$\Delta_2$ $\Delta_3$		$\Delta_1$ $\Delta_2$
	$\Delta_1$ $\Delta_3$		$\Delta_2$ $\Delta_3$		$\Delta_1$ $\Delta_2$

**Table 3.** Three-cell networks with two asymmetric inputs and no two-dimensional synchrony subspaces.

 <i>E<sub>6</sub>&amp;B<sub>1</sub></i>	 <i>D<sub>1</sub>&amp;F<sub>3</sub></i>	 <i>B<sub>1</sub>&amp;F<sub>2</sub></i>
 <i>D<sub>1</sub>&amp;D<sub>6</sub></i>	 <i>C<sub>1</sub>&amp;A<sub>2</sub></i>	 <i>D<sub>1</sub>&amp;F<sub>6</sub></i>
 <i>A<sub>2</sub>&amp;A<sub>1</sub></i>	 <i>D<sub>1</sub>&amp;A<sub>1</sub></i>	 <i>D<sub>1</sub>&amp;D<sub>2</sub></i>
 <i>D<sub>1</sub>&amp;D<sub>5</sub></i>	 <i>D<sub>1</sub>&amp;B<sub>1</sub></i>	 <i>D<sub>1</sub>&amp;B<sub>2</sub></i>
 <i>D<sub>1</sub>&amp;E<sub>4</sub></i>	 <i>E<sub>6</sub>&amp;A<sub>2</sub></i>	 <i>D<sub>1</sub>&amp;A<sub>2</sub></i>
 <i>B<sub>1</sub>&amp;B<sub>3</sub></i>	 <i>B<sub>1</sub>&amp;A<sub>2</sub></i>	 <i>F<sub>1</sub>&amp;A<sub>2</sub></i>
 <i>F<sub>1</sub>&amp;A<sub>1</sub></i>		

By corollary 4.4, a three-cell network with two asymmetric inputs is not minimal if and only if the two inputs are equal. In this case the network is ODE-equivalent to a three-cell network with one input.

**Theorem 5.2.** *Up to ODE-equivalence, there are 48 minimal three-cell connected networks with two asymmetric inputs. See tables 3–6.*

**Proof.** Excluding the network where each cell receives only one self-loop, there are 26 networks with three cells and one input, which are listed in table 2 and obtained by permuting the cells on the networks in table 1. It follows then, from corollary 4.4, that there are  $26 \times 25 = 650$  minimal networks with three cells and two asymmetric inputs. Since we are interested in minimal networks, up to ODE-equivalence, we consider the networks up to interchange of the edge types, which gives 325 networks. Among the networks with one input in table 2, there are two (networks  $A_1$  and  $A_2$ ) with  $\mathbf{Z}_3$ -symmetry, six (networks  $B_i$  and  $C_i$ , with  $i = 1, 2, 3$ ) with  $\mathbf{Z}_2$ -symmetry and the remaining 18 networks have no symmetry. If we apply the same permutation on the two inputs, we obtain ODE-equivalent networks. So, the symmetries of a network exclude some cases. For example, taking the symmetries of  $A_1$ , we see that the networks  $A_1$  &  $B_1$ ,  $A_1$  &  $B_2$  and  $A_1$  &  $B_3$  are ODE-equivalent. Taking a permutation that transforms  $A_1$  into  $A_2$ , we see that  $A_1$  &  $B_1$  and  $A_2$  &  $B_1$  are ODE-equivalent. Moreover, we can see that every network with one input  $A$  and one input  $B$  are ODE-equivalent. When considering the union of networks  $A$  with networks  $A, B, C, D, E, F$ , since we are interested in networks up to re-enumeration of the cells, we can consider only the union of network  $A_1$  with networks  $A_2, B, C, D, E, F$ . Given the  $\mathbf{Z}_3$ -symmetry of  $A_1$ , the  $\mathbf{Z}_2$ -symmetry of networks  $B$  and  $C$  and no symmetry of networks  $D, E, F$ , up to re-enumeration of the cells, we get, respectively, 1, 1, 1, 2, 2, 2 networks. When considering the union of networks  $B$  with networks  $B, C, D, E, F$ , since we are interested in networks up to re-enumeration of the cells, we can consider only the union of network  $B_1$  with networks  $B_2, B_3, C, D, E, F$ . Given the  $\mathbf{Z}_2$ -symmetry of networks  $B$  and  $C$  and no symmetry of networks  $D, E, F$ , up to re-enumeration of the cells, we get, respectively, 1, 2, 3, 3, 3 networks. When considering the union of networks  $C$  with networks  $C, D, E, F$ , since we are interested in networks up to re-enumeration of the cells, we can consider only the union of network  $C_1$  with networks  $C_2, C_3, D, E, F$ . Given the  $\mathbf{Z}_2$ -symmetry of networks  $C$  and no symmetry of networks  $D, E, F$ , up to re-enumeration of the cells, we get, respectively, 1, 3, 3, 3 networks. When considering the union of networks  $D$  with networks  $D, E, F$ , since we are interested at networks up to re-enumeration of the cells, we consider only the union of network  $D_1$  with networks  $D_2, D_3, D_4, D_5, D_6, E, F$ . Since the networks  $D, E, F$  have no symmetry we get, respectively, 5, 6, 6 networks. Analogously, making the union of networks  $E$  with networks  $E, F$  we get, respectively, 5, 6 networks and making the union networks  $F$  with networks  $F$  we get 5 networks. Thus, among the 325 networks with two asymmetric inputs, up to re-enumeration of the cells, there are 64 networks. From the set of these 64 networks, we find the bigger subset of no ODE-equivalent networks using MATLAB. Following theorem 3.2, we implemented a program in MATLAB that checks if two triplets  $\{\text{Id}_3, M_1, M_2\}$  and  $\{\text{Id}_3, M_3, M_4\}$  span the same linear space, where  $M_1, M_2, M_3$  and  $M_4$  are valency one adjacency matrices. Applying this code to every pair of the 64 networks, we obtain the 48 minimal three-cell networks with two asymmetric inputs listed in tables 3–6.  $\square$

**Theorem 5.3.** *Among the 48 minimal three-cell connected networks with two asymmetric inputs given by theorem 5.2, there are 19 networks with no two-dimensional synchrony subspaces (see table 3), 21 networks with one two-dimensional synchrony subspace (see table 4), 7 networks with two two-dimensional synchrony subspaces (see table 5) and one network with three two-dimensional synchrony subspaces (see table 6).*

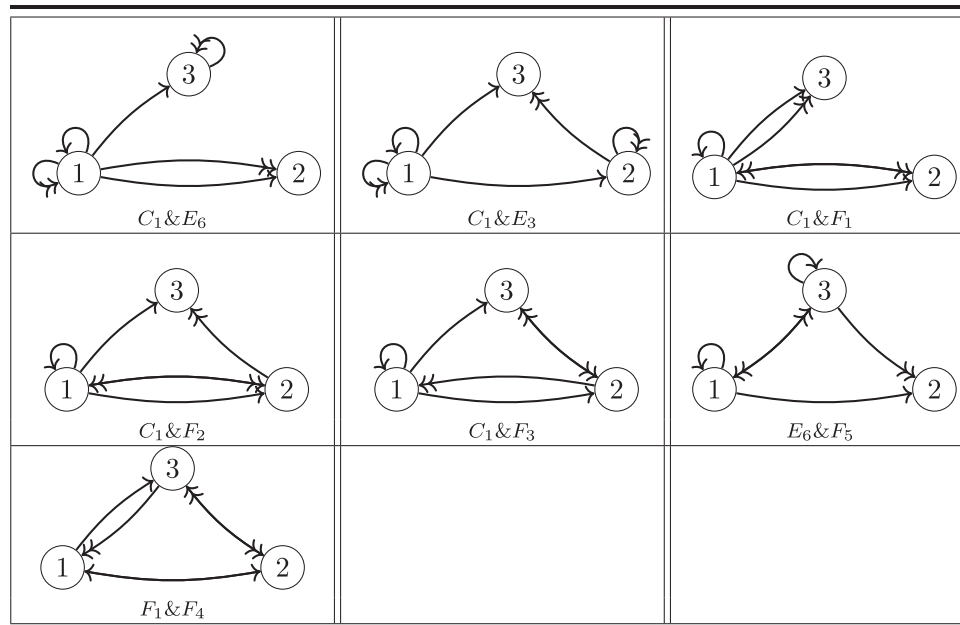

**Table 4.** Three-cell networks with two asymmetric inputs and one two-dimensional synchrony subspace.

 $E_6 \& E_4$	 $D_1 \& E_1$	 $C_1 \& D_1$
 $D_1 \& F_1$	 $C_1 \& D_4$	 $D_1 \& F_2$
 $C_1 \& D_6$	 $D_1 \& B_3$	 $D_1 \& D_4$
 $D_1 \& F_5$	 $C_1 \& B_1$	 $D_1 \& F_4$
 $C_1 \& B_3$	 $E_6 \& F_3$	 $D_1 \& E_6$
 $E_6 \& F_6$	 $E_6 \& F_4$	 $B_1 \& F_1$
 $F_1 \& F_2$	 $F_1 \& F_3$	 $F_1 \& F_6$

**Proof.** Let  $G$  be a minimal three-cell connected network with two asymmetric inputs. Then,  $G = G_1 \cup G_2$  with  $G_1$  and  $G_2$  three-cell networks with one input, both in table 2. The network

**Table 5.** Three-cell networks with two asymmetric inputs and two two-dimensional synchrony subspaces.



**Table 6.** Three-cell network with two asymmetric inputs and three two-dimensional synchrony subspaces.

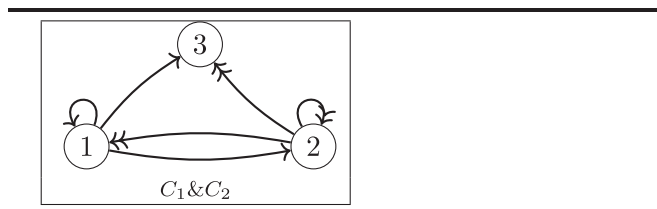

$G$  has a synchrony subspace  $\Delta_i$  if and only if  $\Delta_i$  is a synchrony subspace for both networks  $G_1$  and  $G_2$ . Using the information in table 2, we obtain the information above stated concerning the synchrony spaces of the minimal three-cell connected networks with two asymmetric inputs.  $\square$

**Remark 5.4.** In [4], Aguiar *et al* consider the strongly connected networks of three cells and two asymmetric inputs that have one or two two-dimensional synchrony subspace. If, among the 48 minimal three-cell connected networks with two asymmetric inputs given by theorem 5.2, we consider only the strongly connected ones, that have one or two two-dimensional network synchrony subspaces, then we see that there are only eight networks with one two-dimensional synchrony subspace ( $C_1 \& D_6$ ,  $D_1 \& F_5$ ,  $D_1 \& F_4$ ,  $E_6 \& F_3$ ,  $E_6 \& F_4$ ,  $B_1 \& F_1$ ,  $F_1 \& F_3$ ,  $F_1 \& F_6$  from table 4) and two networks with two two-dimensional synchrony subspaces ( $C_1 \& F_3$ ,  $F_1 \& F_4$  from table 5).



### 5.3. ODE-distinct three-cell two-input asymmetric networks with the same hidden symmetries

Rink and Sanders [19, 25] show that networks with asymmetric inputs have hidden symmetries which influence the network dynamics and moreover, can be used to study the dynamics. When the network has a semigroup structure, Rink and Sanders in [25] have calculated normal forms of coupled cell systems and in [24] have used the hidden symmetries of the network to derive Lyapunov–Schmidt reduction that preserves hidden symmetries. In [19], Nijholt *et al* have introduced the concept of fundamental network which reveals the hidden symmetries of a network. A fundamental network is a Cayley graph of a monoid (semigroup with unity). The dynamics associated to a fundamental network can be studied using the revealed hidden symmetries and be related with the dynamics associated to the original network which does not need to be fundamental [24, theorem 3.7 & remark 3.9].

In section 7 of [24], it is considered fundamental networks with two or three cells and their possible generic codimension-one steady-state bifurcations that can occur assuming that the cell phase spaces are one-dimensional. It is remarked that these systems are fully characterized by their monoid symmetry, moreover, their semigroup representations split as the sum of mutually nonisomorphic indecomposable representations. In their classification, in case of monoid networks with three cells, it is used the fact that, there are up to isomorphism, precisely seven monoids with three elements (see [12]).

In this section, we make two observations. We first remark that from the 48 networks with three cells and two asymmetric inputs obtained in theorem 5.2, there are only eight networks which have symmetry monoids with three elements. Moreover, only seven of these are fundamental networks, where all the possible seven monoids with three elements occur in this list of eight networks. The other 40 networks have symmetry monoids with more than three elements. The second remark concerns the fact that there are ODE-distinct three-cell networks with the same symmetry monoid of three elements.

In what follows, a three-cell network with two asymmetric inputs denoted by  $G_1$  &  $G_2$ , has each edge type  $j$ , for  $j = 1, 2$ , represented by a function  $\sigma_j: \{1, 2, 3\} \rightarrow \{1, 2, 3\}$  such that  $\sigma_j(l) = a_l$ , for  $l = 1, 2, 3$ , and we represent it by  $\sigma_j = [a_1 a_2 a_3]$ . Thus, if we take the edge type  $j$  and  $\sigma_j(l) = a_l$ , then there is an edge of the type  $j$  from cell  $a_l$  to cell  $l$  which corresponds to an edge from cell  $a_l$  to cell  $l$  in the network  $G_j$ . The multiplication operation is given by the composition of such functions.

**Proposition 5.5.** *From the 48 networks with three cells and two asymmetric inputs obtained in theorem 5.2, only eight have symmetry monoids with three elements:  $A_2$  &  $A_1$ ,  $E_6$  &  $E_4$ ,  $C_1$  &  $D_1$ ,  $C_1$  &  $B_1$ ,  $E_6$  &  $F_5$ ,  $C_1$  &  $C_2$ ,  $C_1$  &  $E_3$  and  $C_1$  &  $E_6$ . Each corresponds to one of the seven distinct possible symmetry monoids with three elements, except the last two that have the same symmetry monoid. See tables 7 and 8.*

**Proof.** The symmetry monoid of each  $G_1$  &  $G_2$  in the list of the 48 networks with three cells and two asymmetric inputs in tables 3–6 is determined by three functions:  $\sigma_0 = \text{Id}_3$  and  $\sigma_1, \sigma_2$  corresponding to the subnetworks with one input,  $G_1$  and  $G_2$ , respectively. Except for the eight networks ( $A_2$  &  $A_1$ ,  $E_6$  &  $E_4$ ,  $C_1$  &  $D_1$ ,  $C_1$  &  $B_1$ ,  $E_6$  &  $F_5$ ,  $C_1$  &  $C_2$ ,  $C_1$  &  $E_3$  and  $C_1$  &  $E_6$ ), the set  $\Sigma = \{\sigma_0, \sigma_1, \sigma_2\}$  is not closed for the composition. In fact, for those 40 networks, at least one of the products  $\sigma_1\sigma_2$  or  $\sigma_2\sigma_1$  does not belong to  $\Sigma$ . Now, for the other eight networks, we see that  $\Sigma = \{\sigma_0, \sigma_1, \sigma_2\}$  is closed under multiplication (composition) and we have all the possibilities for the products  $\sigma_i\sigma_j$  where  $i, j \neq 1, 2$ . See tables 7 and 8 for the matching between each of the eight networks and the corresponding symmetry monoid. As an example, if we take



**Table 7.** The eight ODE-distinct networks with three cells and two asymmetric inputs which have symmetry monoids with three elements, and the corresponding symmetry monoids. The monoids  $\Sigma_i$  for  $i = 1, \dots, 7$  appear in table 8. Except  $C_1$  &  $E_6$ , they are fundamental networks. Here,  $\sigma_0$  represents the dependence of each cell on its own state which we omit in the network representation.

Network	Monoid symmetries	Monoid structure
$A_2$ & $A_1$	$\sigma_0 = [1\ 2\ 3], \sigma_1 = [2\ 3\ 1], \sigma_2 = [3\ 1\ 2]$	$\Sigma_6$
$E_6$ & $E_4$	$\sigma_0 = [1\ 2\ 3], \sigma_1 = [1\ 1\ 3], \sigma_2 = [1\ 3\ 3]$	$\Sigma_5$
$C_1$ & $D_1$	$\sigma_0 = [1\ 2\ 3], \sigma_1 = [1\ 1\ 1], \sigma_2 = [1\ 1\ 2]$	$\Sigma_1$
$C_1$ & $B_1$	$\sigma_0 = [1\ 2\ 3], \sigma_1 = [1\ 1\ 1], \sigma_2 = [1\ 3\ 2]$	$\Sigma_7$
$E_6$ & $F_5$	$\sigma_0 = [1\ 2\ 3], \sigma_1 = [1\ 1\ 3], \sigma_2 = [3\ 3\ 1]$	$\Sigma_2$
$C_1$ & $C_2$	$\sigma_0 = [1\ 2\ 3], \sigma_1 = [1\ 1\ 1], \sigma_2 = [2\ 2\ 2]$	$\Sigma_4$
$C_1$ & $E_3$	$\sigma_0 = [1\ 2\ 3], \sigma_1 = [1\ 1\ 1], \sigma_2 = [1\ 2\ 2]$	$\Sigma_3$
$C_1$ & $E_6$	$\sigma_0 = [1\ 2\ 3], \sigma_1 = [1\ 1\ 1], \sigma_2 = [1\ 1\ 3]$	$\Sigma_3$

the network  $A_2$  &  $A_1$ , we have that

$$\sigma_0 = [1\ 2\ 3], \quad \sigma_1 = [2\ 3\ 1], \quad \sigma_2 = [3\ 1\ 2].$$

It follows that  $\Sigma = \{\sigma_0, \sigma_1, \sigma_2\}$  is a monoid. Moreover, as  $\sigma_1^2 = \sigma_2$ ,  $\sigma_2^2 = \sigma_1$  and  $\sigma_1\sigma_2 = \sigma_2\sigma_1 = \sigma_0$ , we have that the multiplication table for  $\Sigma$  corresponds to  $\Sigma_6$  in table 8 (it corresponds to the  $\Sigma_6$  in section 7 of [24]).  $\square$

**Remark 5.6.** The eight three-cell networks with symmetry monoids with three elements have the following properties according to the number of nontrivial synchrony spaces:  $A_2$  &  $A_1$  has no nontrivial synchrony space (from table 3);  $E_6$  &  $E_4$ ,  $C_1$  &  $D_1$  and  $C_1$  &  $B_1$  have one nontrivial synchrony space (from table 4);  $E_6$  &  $F_5$ ,  $C_1$  &  $E_6$  and  $C_1$  &  $E_3$  have two nontrivial synchrony spaces (from table 5);  $C_1$  &  $C_2$  has three nontrivial synchrony spaces (from table 6).

**Remark 5.7.** The networks  $C_1$  &  $E_3$  and  $C_1$  &  $E_6$  are ODE-distinct and have the same symmetry monoid. Thus they have the same fundamental network. Which in this case is the network with set of three cells  $\Sigma = \{\sigma_0, \sigma_1, \sigma_2\}$  and the asymmetric inputs can be read off from the multiplication table of  $\Sigma_3$  in table 8 (recall that  $\tilde{\sigma}_j$  encodes the left-multiplicative behaviour of  $\sigma_j$ ):

$$\tilde{\sigma}_0 = [1\ 2\ 3], \quad \tilde{\sigma}_1 = [2\ 2\ 2], \quad \tilde{\sigma}_2 = [3\ 2\ 3].$$

In fact, this three-cell fundamental network with asymmetric inputs  $\tilde{\sigma}_1$  and  $\tilde{\sigma}_2$  corresponds to an isomorphic network of  $C_1$  &  $E_3$ . Thus  $C_1$  &  $E_3$  is a fundamental network and  $C_1$  &  $E_6$  is not. The other six networks are fundamental networks. See table 9 for the asymmetric inputs for each of the fundamental networks  $\tilde{\Sigma}_i$  associated with each of the monoids  $\Sigma_i$  in table 8.

**Remark 5.8.** More generally, Aguiar *et al* [7, theorem 5.16] present a set of necessary and sufficient conditions (on the topology of the network) for a network with asymmetric inputs to be a fundamental network. One of such properties is the backward connectivity of the graph (i.e., there exists a cell such that any other cell has a directed path ending in that cell). We remark that the network  $C_1$  &  $E_6$  mentioned in the previous remark is not backward connected.



**Table 8.** Up to isomorphism, there are seven monoids with three elements [12].

$\Sigma_1$	$\sigma_0$	$\sigma_1$	$\sigma_2$	$\Sigma_2$	$\sigma_0$	$\sigma_1$	$\sigma_2$
$\sigma_0$	$\sigma_0$	$\sigma_1$	$\sigma_2$	$\sigma_0$	$\sigma_0$	$\sigma_1$	$\sigma_2$
$\sigma_1$	$\sigma_1$	$\sigma_1$	$\sigma_1$	$\sigma_1$	$\sigma_1$	$\sigma_1$	$\sigma_2$
$\sigma_2$	$\sigma_2$	$\sigma_1$	$\sigma_1$	$\sigma_2$	$\sigma_2$	$\sigma_2$	$\sigma_1$

$\Sigma_3$	$\sigma_0$	$\sigma_1$	$\sigma_2$	$\Sigma_4$	$\sigma_0$	$\sigma_1$	$\sigma_2$
$\sigma_0$	$\sigma_0$	$\sigma_1$	$\sigma_2$	$\sigma_0$	$\sigma_0$	$\sigma_1$	$\sigma_2$
$\sigma_1$	$\sigma_1$	$\sigma_1$	$\sigma_1$	$\sigma_1$	$\sigma_1$	$\sigma_1$	$\sigma_1$
$\sigma_2$	$\sigma_2$	$\sigma_1$	$\sigma_2$	$\sigma_2$	$\sigma_2$	$\sigma_2$	$\sigma_2$

$\Sigma_5$	$\sigma_0$	$\sigma_1$	$\sigma_2$	$\Sigma_6$	$\sigma_0$	$\sigma_1$	$\sigma_2$
$\sigma_0$	$\sigma_0$	$\sigma_1$	$\sigma_2$	$\sigma_0$	$\sigma_0$	$\sigma_1$	$\sigma_2$
$\sigma_1$	$\sigma_1$	$\sigma_1$	$\sigma_2$	$\sigma_1$	$\sigma_1$	$\sigma_2$	$\sigma_0$
$\sigma_2$	$\sigma_2$	$\sigma_1$	$\sigma_2$	$\sigma_2$	$\sigma_2$	$\sigma_0$	$\sigma_1$

$\Sigma_7$	$\sigma_0$	$\sigma_1$	$\sigma_2$
$\sigma_0$	$\sigma_0$	$\sigma_1$	$\sigma_2$
$\sigma_1$	$\sigma_1$	$\sigma_1$	$\sigma_1$
$\sigma_2$	$\sigma_2$	$\sigma_1$	$\sigma_0$

**Table 9.** The seven fundamental networks with three cells and two asymmetric inputs corresponding to the symmetry monoids with three elements in table 8. Here,  $\tilde{\sigma}_0$  represents the dependence of each cell on its own state.

Fundamental network	Monoid symmetries
$\tilde{\Sigma}_1$	$\tilde{\sigma}_0 = [1\ 2\ 3], \tilde{\sigma}_1 = [2\ 2\ 2], \tilde{\sigma}_2 = [3\ 2\ 2]$
$\tilde{\Sigma}_2$	$\tilde{\sigma}_0 = [1\ 2\ 3], \tilde{\sigma}_1 = [2\ 2\ 3], \tilde{\sigma}_2 = [3\ 3\ 2]$
$\tilde{\Sigma}_3$	$\tilde{\sigma}_0 = [1\ 2\ 3], \tilde{\sigma}_1 = [2\ 2\ 2], \tilde{\sigma}_2 = [3\ 2\ 3]$
$\tilde{\Sigma}_4$	$\tilde{\sigma}_0 = [1\ 2\ 3], \tilde{\sigma}_1 = [2\ 2\ 3], \tilde{\sigma}_2 = [3\ 2\ 3]$
$\tilde{\Sigma}_5$	$\tilde{\sigma}_0 = [1\ 2\ 3], \tilde{\sigma}_1 = [2\ 2\ 2], \tilde{\sigma}_2 = [3\ 3\ 3]$
$\tilde{\Sigma}_6$	$\tilde{\sigma}_0 = [1\ 2\ 3], \tilde{\sigma}_1 = [2\ 3\ 1], \tilde{\sigma}_2 = [3\ 1\ 2]$
$\tilde{\Sigma}_7$	$\tilde{\sigma}_0 = [1\ 2\ 3], \tilde{\sigma}_1 = [2\ 2\ 2], \tilde{\sigma}_2 = [3\ 2\ 1]$

**6. Why the number  $n(n - 1)$  of inputs for an  $n$ -cell network with asymmetric inputs is special?**

As a first step towards obtaining a classification, in terms of ODE-classes, of the  $n$ -cell networks with asymmetric inputs, for a fixed  $n$ , we show next that for every ODE-class of  $n$ -cell networks with asymmetric inputs, the minimal networks have at most  $n(n - 1)$  asymmetric inputs.

Given a positive integer  $n$ , consider the  $n^2$ -dimensional real linear space of the  $n \times n$  matrices  $M_{n \times n}(\mathbb{R})$  with the usual operations of sum of matrices and scalar product of matrices by reals. Denote by  $V_{1,n}$ , the subspace of  $M_{n \times n}(\mathbb{R})$  generated by the valency one  $n \times n$  matrices (with integer entries 0, 1).

**Theorem 6.1.** For  $n \geq 1$ , the dimension of the linear subspace  $V_{1,n}$  of  $M_{n \times n}(\mathbb{R})$  is  $n(n - 1) + 1$ .

**Proof.** Let  $d_n = n(n - 1) + 1$ . We show that  $V_{1,n}$  has dimension  $d_n$ . Note that  $M_{n \times n}(\mathbb{R})$  has dimension  $n^2$ . We first observe that  $V_{1,n}$  has dimension at most  $d_n$ . There are  $N = n^n$  valency one square matrices of order  $n$ , say  $B_1, \dots, B_N$ . Using the isomorphism between  $M_{n \times n}(\mathbb{R})$  and  $\mathbb{R}^{n^2}$  mapping  $A = [a_{ij}]$  to the column vector  $(a_{11}, \dots, a_{1n}, \dots, a_{n1}, \dots, a_{nn})^T$ , take the  $n^2 \times N$  matrix  $B$  whose columns correspond to those  $N$  matrices. It follows that, the sum of the  $n$  first rows of  $B$  is the row  $(11 \dots 1)$ , and the same row sum is obtained for the following groups each with  $n$  rows. Thus the rank of the matrix  $B$  is at most  $d_n = n^2 - (n - 1)$ . We show now that there are indeed  $d_n$  linearly independent matrices  $B_i$ . There is a specific choice of valency one adjacency matrices  $B_i$ , such that we get the  $n^2 \times d_n$  submatrix  $\overline{B}$  of  $B$  with the following block structure:

$$\overline{B} = \begin{bmatrix} \text{Id}_n & L_1 & L_1 & \cdots & L_1 & L_1 \\ L_2 & I & L_1 & \cdots & L_1 & L_1 \\ L_2 & L_1 & I & \cdots & L_1 & L_1 \\ \vdots & \vdots & \vdots & \ddots & \vdots & \vdots \\ L_2 & L_1 & L_1 & \cdots & I & L_1 \\ L_2 & L_1 & L_1 & \cdots & L_1 & I \end{bmatrix}.$$

Here the blocks  $I, L_1$  are  $n \times (n - 1)$  and  $L_2$  is  $n \times n$  having the form:

$$I = \begin{bmatrix} \text{Id}_{n-1} \\ 0_{1,n-1} \end{bmatrix}, \quad L_1 = \begin{bmatrix} 0_{n-1,n-1} \\ 1_{1,n-1} \end{bmatrix}, \quad L_2 = \begin{bmatrix} 0_{n-1,n} \\ 1_{1,n} \end{bmatrix}.$$

Using the elementary operations on the columns of  $\overline{B}$ , for  $i = n + 1, \dots, d_n$ , replacing the column  $C_i$  by  $C_i - C_n$ , we obtain the matrix:

$$S = \begin{bmatrix} \text{Id}_n & 0_{n,n-1} & 0_{n,n-1} & \cdots & 0_{n,n-1} & 0_{n,n-1} \\ L_2 & I^* & 0_{n,n-1} & \cdots & 0_{n,n-1} & 0_{n,n-1} \\ L_2 & 0_{n,n-1} & I^* & \cdots & 0_{n,n-1} & 0_{n,n-1} \\ \vdots & \vdots & \vdots & \ddots & \vdots & \vdots \\ L_2 & 0_{n,n-1} & 0_{n,n-1} & \cdots & I^* & 0_{n,n-1} \\ L_2 & 0_{n,n-1} & 0_{n,n-1} & \cdots & 0_{n,n-1} & I^* \end{bmatrix}$$

where

$$I^* = \begin{bmatrix} \text{Id}_{n-1} \\ -1_{1,n-1} \end{bmatrix}.$$

Clearly, the rank of  $S$  is  $n + (n - 1)(n - 1)$ , that is,  $d_n = n(n - 1) + 1$ . □

In this and the following section, we will use and study matrices with the same construction as matrices  $B$  and  $\overline{B}$  in the proof above.

**Example 6.2.** To illustrate the above result, we consider the three-cell networks with asymmetric inputs. As we have showed, the dimension  $d_3$  of the linear subspace  $V_{1,3}$  of  $M_{3,3}(\mathbb{R})$ ,

generated by the valency one  $3 \times 3$  matrices, is 7. We take the following  $3 \times 3$  valency one matrices:

$$\begin{aligned}
 M_1 &= \begin{bmatrix} 1 & 0 & 0 \\ 0 & 0 & 1 \\ 0 & 0 & 1 \end{bmatrix}, & M_2 &= \begin{bmatrix} 0 & 1 & 0 \\ 0 & 0 & 1 \\ 0 & 0 & 1 \end{bmatrix}, & M_3 &= \begin{bmatrix} 0 & 0 & 1 \\ 0 & 0 & 1 \\ 0 & 0 & 1 \end{bmatrix}, \\
 M_4 &= \begin{bmatrix} 0 & 0 & 1 \\ 1 & 0 & 0 \\ 0 & 0 & 1 \end{bmatrix}, & M_5 &= \begin{bmatrix} 0 & 0 & 1 \\ 0 & 1 & 0 \\ 0 & 0 & 1 \end{bmatrix}, & M_6 &= \begin{bmatrix} 0 & 0 & 1 \\ 0 & 0 & 1 \\ 1 & 0 & 0 \end{bmatrix}, \\
 M_7 &= \begin{bmatrix} 0 & 0 & 1 \\ 0 & 0 & 1 \\ 0 & 1 & 0 \end{bmatrix}
 \end{aligned}$$

- (a) Using the isomorphism  $M_{3 \times 3}(\mathbb{R}) \rightarrow \mathbb{R}^9$  mapping  $A = [a_{ij}]$  to the column vector  $(a_{11} \ a_{12} \ \dots \ a_{33})^t$ , we can form the  $9 \times 7$  matrix whose columns correspond to the above 7 matrices:

$$\left[ \begin{array}{ccc|ccc}
 1 & 0 & 0 & 0 & 0 & 0 & 0 \\
 0 & 1 & 0 & 0 & 0 & 0 & 0 \\
 0 & 0 & 1 & 1 & 1 & 1 & 1 \\
 \hline
 0 & 0 & 0 & 1 & 0 & 0 & 0 \\
 0 & 0 & 0 & 0 & 1 & 0 & 0 \\
 1 & 1 & 1 & 0 & 0 & 1 & 1 \\
 \hline
 0 & 0 & 0 & 0 & 0 & 1 & 0 \\
 0 & 0 & 0 & 0 & 0 & 0 & 1 \\
 1 & 1 & 1 & 1 & 1 & 0 & 0
 \end{array} \right].$$

This matrix is the submatrix  $\bar{B}$  in the proof of theorem 6.1, when  $n = 3$ . Thus the matrices  $M_1, \dots, M_7$  form a basis of  $V_{1,3}$ .

- (b) Consider now the seven three-cell networks with one input and adjacency matrices  $M_1, \dots, M_7$ , say  $G_1, \dots, G_7$ , respectively. We have that  $[G_1] = [G_5]$ ,  $[G_2] = [G_4]$  and  $[G_6] = [G_7]$ , and that  $G_1, G_2, G_3, G_6$  are minimal representatives of four distinct ODE-classes.
- (c) We have

$$A = \begin{bmatrix} 0 & 0 & 1 \\ 1 & 0 & 0 \\ 0 & 1 & 0 \end{bmatrix} = -M_3 + M_4 + M_7$$

and so  $\{A, M_1, M_2, M_3, M_4, M_5, M_6\}$  is also a basis of  $V_{1,3}$ . Similarly, we have

$$B = \begin{bmatrix} 1 & 0 & 0 \\ 0 & 0 & 1 \\ 0 & 1 & 0 \end{bmatrix} = A + M_1 - M_4.$$



Thus  $\{A, B, M_1, M_2, M_3, M_5, M_6\}$  is also a basis of  $V_{1,3}$ . Finally, we have that  $\text{Id}_3 = M_1 - M_3 + M_5$ . We get then that  $\{\text{Id}_3, A, B, M_1, M_2, M_3, M_6\}$  is also a basis of  $V_{1,3}$ . We saw in lemma 5.1 that  $A, B, M_1, M_2, M_3, M_6$  are adjacency matrices of representatives of the (six) distinct ODE-classes of the three-cell networks with one input. The networks  $M_1, M_2, M_3, M_6$  need to be re-enumerated to obtain, respectively, the networks  $E, D, C, F$  in table 1. Recall that the re-enumeration of the cells of a network does not change its ODE-class.

**Theorem 6.3.** *If  $G$  is an  $n$ -cell network with  $k$  asymmetric inputs which is minimal then  $k \leq n(n-1)$ .*

**Proof.** By the previous theorem,  $V_{1,n}$  has dimension  $d_n = n^2 - (n-1)$ . The result follows trivially, as if  $G$  is an  $n$ -cell network with  $k$  asymmetric inputs given by the valency one adjacency matrices  $A_1, \dots, A_k$ , by proposition 4.2,  $G$  is minimal if and only if the matrices  $\text{Id}_n, A_1, \dots, A_k$  are linearly independent. Thus, in particular,  $A_i \neq \text{Id}_n$ , for  $i = 1, \dots, k$  and  $k$  is at most  $d_n - 1 = n(n-1)$ .  $\square$

**Corollary 6.4.** *An  $n$ -cell network with asymmetric inputs is ODE-equivalent to an  $n$ -cell network with at most  $n(n-1)$  asymmetric inputs.*

We have then that if  $G$  is an  $n$ -cell minimal network with  $m$  asymmetric inputs then  $m \leq n(n-1)$ . In particular, we have that for all  $k > n(n-1)$ ,

$$\text{Min}_{k,n} = \emptyset.$$

As remarked before, if there is no restriction on the inputs, then the number of distinct ODE-classes of  $n$ -cell networks is not finite. However, if we restrict to networks with asymmetric inputs, as the number of  $n$ -cell networks with asymmetric inputs with at most  $n(n-1)$  asymmetric inputs is finite, it also follows from corollary 6.4 that:

**Theorem 6.5.** *The number of distinct ODE-classes of  $n$ -cell networks with asymmetric inputs is finite.*

**Example 6.6.** Consider the set of two-cell networks with asymmetric inputs. We have by corollary 6.4 that any such network is ODE-equivalent to a two-cell network with at most 2 asymmetric inputs. Moreover, by theorem 6.3, the linear space  $V_{1,2}$  generated by the  $2 \times 2$  valency one matrices (with integer entries 0, 1) is three-dimensional. For example  $\text{Id}_2$  and

$$A_1 = \begin{bmatrix} 1 & 0 \\ 1 & 0 \end{bmatrix}, \quad A_2 = \begin{bmatrix} 0 & 1 \\ 1 & 0 \end{bmatrix}$$

form a basis of  $V_{1,2}$ . We can check that, up to ODE-equivalence, there are only 4 classes of two-cell networks with asymmetric inputs, with the following representative networks: the two-cell network with no inputs, two 1-input networks given by  $A_1$  and  $A_2$ , and one network with two asymmetric inputs given by  $A_1, A_2$ .

## 7. The ODE-class of the $n$ -cell networks with $n(n-1)$ asymmetric inputs

In this section, we start by observing that there is a unique ODE-class of the  $n$ -cell networks with  $n(n-1)$  asymmetric inputs. We then address the issue of finding a minimal representative of that class.

As a direct consequence of theorem 6.1, we have that:

**Corollary 7.1.** *If  $n$  is a positive integer then all networks in  $\text{Min}_{n(n-1),n}$  are ODE-equivalent.*

**Proof.** Given two (minimal) networks  $G_1, G_2 \in \text{Min}_{n(n-1),n}$ , with adjacency matrices  $A_i$  and  $B_i$ , respectively, for  $i = 1, \dots, n(n-1)$ , we have that  $\text{Id}_n, A_1, \dots, A_{n(n-1)}$  are linearly independent. Similarly,  $\text{Id}_n, B_1, \dots, B_{n(n-1)}$  are linearly independent. Thus both sets form a basis of  $V_{1,n}$ , that is,  $G_1$  and  $G_2$  are ODE-equivalent.  $\square$

Given an  $n$ -cell network  $G$  with adjacency matrix  $A_G$  and given a permutation  $\pi \in \mathbf{S}_n$  on its set of cells  $\{1, \dots, n\}$ , we denote by  $\pi G$  the network obtained from  $G$  by permuting the cells according to  $\pi$ . Thus the adjacency matrix of  $\pi G$  is  $P_\pi^{-1}A_G P_\pi$ , where  $P_\pi$  is the permutation matrix corresponding to  $\pi$ .

Note that any representative of the ODE-class  $\text{Min}_{n(n-1),n}$  is the union network of  $n(n-1)$  networks in  $\text{Min}_{1,n}$ . In the next section, we show that  $\text{Min}_{1,n}$  has at least  $n(n-1)$  distinct ODE-classes. It might seem natural that selecting any network in each of those classes, then their union would be a minimal network in  $\text{Min}_{n(n-1),n}$ . The following example shows that this depends on the networks in  $\text{Min}_{1,n}$  that we select.

**Example 7.2.** Fix  $n = 3$  and consider the six distinct ODE-classes of the three-cell minimal networks with one input, given by lemma 5.1. As remarked in example 6.2 the adjacency matrices of the representatives of the six distinct ODE-classes, the networks  $A, \dots, F$  in table 1 are linearly independent together with the identity matrix  $\text{Id}_3$ . Thus, the union of the six networks  $A, \dots, F$  is a minimal network in  $\text{Min}_{6,3}$ . However, if we consider instead the representatives  $A, \pi_1 B, \pi_2 C, \pi_3 D, \pi_3 E, \pi_2 F$ , where  $\pi_1, \pi_2, \pi_3$ , are the cell permutations given by  $\pi_1 = (321)$ ,  $\pi_2 = (213)$  and  $\pi_3 = (312)$ , then the subspace generated by the corresponding adjacency matrices, together with  $\text{Id}_3$ , has dimension  $4 \neq 7$ . It follows that the union of the networks  $A, \pi_1 B, \pi_2 C, \pi_3 D, \pi_3 E, \pi_2 F$  is not a minimal network in  $\text{Min}_{6,3}$ .

For the case  $n = 4$ , if we select randomly twelve ODE-distinct classes in  $\text{Min}_{1,4}$ , we have noticed that we will not obtain a representative of  $\text{Min}_{12,4}$ . However, the next example shows that, we may find two such representatives of  $\text{Min}_{12,4}$  using distinct ODE-classes in  $\text{Min}_{1,4}$ .

**Example 7.3.** We present below two  $16 \times 13$  matrices with rank 13, each corresponding to a different choice of networks in  $\text{Min}_{1,4}$ . The first column of each of those matrices corresponds to the matrix  $\text{Id}_4$  and the other twelve columns to the adjacency matrices of the networks in the corresponding subset:

$$\left[ \begin{array}{c|cccc|cccc|ccc} 1 & 1 & 1 & 1 & 1 & 1 & 0 & 0 & 0 & 0 & 0 & 0 & 0 \\ 0 & 0 & 0 & 0 & 0 & 0 & 1 & 1 & 1 & 1 & 0 & 0 & 0 \\ 0 & 0 & 0 & 0 & 0 & 0 & 0 & 0 & 0 & 0 & 1 & 1 & 0 \\ 0 & 0 & 0 & 0 & 0 & 0 & 0 & 0 & 0 & 0 & 0 & 0 & 1 \\ \hline 0 & 1 & 0 & 1 & 1 & 0 & 1 & 1 & 1 & 1 & 1 & 1 & 1 \\ 1 & 0 & 0 & 0 & 0 & 0 & 0 & 0 & 0 & 0 & 0 & 0 & 0 \\ 0 & 0 & 1 & 0 & 0 & 0 & 0 & 0 & 0 & 0 & 0 & 0 & 0 \\ 0 & 0 & 0 & 0 & 0 & 1 & 0 & 0 & 0 & 0 & 0 & 0 & 0 \\ \hline 0 & 0 & 1 & 1 & 1 & 1 & 0 & 0 & 0 & 0 & 0 & 0 & 0 \\ 0 & 0 & 0 & 0 & 0 & 0 & 1 & 0 & 0 & 1 & 1 & 1 & 1 \\ 1 & 1 & 0 & 0 & 0 & 0 & 0 & 1 & 0 & 0 & 0 & 0 & 0 \\ 0 & 0 & 0 & 0 & 0 & 0 & 0 & 0 & 1 & 0 & 0 & 0 & 0 \\ \hline 0 & 0 & 0 & 0 & 1 & 0 & 0 & 0 & 0 & 0 & 0 & 0 & 0 \\ 0 & 0 & 0 & 0 & 0 & 0 & 0 & 0 & 0 & 0 & 0 & 1 & 0 \\ 0 & 0 & 0 & 0 & 0 & 1 & 0 & 0 & 1 & 1 & 0 & 0 & 1 \\ 1 & 1 & 1 & 1 & 0 & 0 & 1 & 1 & 0 & 0 & 1 & 0 & 0 \end{array} \right], \left[ \begin{array}{c|cccc|cccc|ccc} 1 & 1 & 1 & 1 & 1 & 1 & 0 & 0 & 0 & 0 & 0 & 0 & 0 \\ 0 & 0 & 0 & 0 & 0 & 0 & 1 & 1 & 1 & 1 & 0 & 0 & 0 \\ 0 & 0 & 0 & 0 & 0 & 0 & 0 & 0 & 0 & 0 & 1 & 1 & 0 \\ 0 & 0 & 0 & 0 & 0 & 0 & 0 & 0 & 0 & 0 & 0 & 0 & 1 \\ \hline 0 & 1 & 0 & 0 & 0 & 1 & 1 & 1 & 1 & 1 & 1 & 1 & 1 \\ 1 & 0 & 0 & 0 & 1 & 0 & 0 & 0 & 0 & 0 & 0 & 0 & 0 \\ 0 & 0 & 0 & 1 & 0 & 0 & 0 & 0 & 0 & 0 & 0 & 0 & 0 \\ 0 & 0 & 1 & 0 & 0 & 0 & 0 & 0 & 0 & 0 & 0 & 0 & 0 \\ \hline 0 & 0 & 1 & 0 & 1 & 1 & 0 & 0 & 0 & 1 & 0 & 0 & 0 \\ 0 & 0 & 0 & 0 & 0 & 0 & 1 & 1 & 0 & 0 & 1 & 1 & 1 \\ 1 & 1 & 0 & 0 & 0 & 0 & 0 & 0 & 0 & 0 & 0 & 0 & 0 \\ 0 & 0 & 0 & 1 & 0 & 0 & 0 & 0 & 1 & 0 & 0 & 0 & 0 \\ \hline 0 & 0 & 1 & 1 & 0 & 1 & 1 & 0 & 0 & 0 & 0 & 0 & 0 \\ 0 & 0 & 0 & 0 & 0 & 0 & 0 & 1 & 0 & 0 & 0 & 1 & 0 \\ 0 & 0 & 0 & 0 & 1 & 0 & 0 & 0 & 1 & 1 & 0 & 0 & 1 \\ 1 & 1 & 0 & 0 & 0 & 0 & 0 & 0 & 0 & 0 & 1 & 0 & 0 \end{array} \right]$$

For each matrix, its columns correspond to networks with one input which are not ODE-equivalent.

On the other hand, it would be unexpected that the union of a set in  $\text{Min}_{1,n}$  of networks where most are ODE-equivalent would be a network representative of  $\text{Min}_{n(n-1),n}$ . We prove indeed that one such representative is given by considering  $n - 1$  feed-forward networks and their orbits under the cyclic permutation group on the  $n$  cells.

**Lemma 7.4.** *Given  $n \in \mathbb{N}$ , up to permutation of the cells, the number of  $n$ -cell feed-forward networks with one input having at most one tail with length greater than one is  $n - 1$ .*

**Proof.** An  $n$ -cell feed-forward network with one input having at most one tail with length greater than one satisfies one of the following: every tail has length one or one tail has length  $k > 1$  and the other tails have length one. A tail with length  $k$  consists of  $k + 1$  cells. So, if a network has one tail with length  $k$  and the other tails with length one, then the network has  $n - k$  tails. Up to permutation of the cells, two networks of the type above are the same if and only their longest tail have the same length. Note that  $k$  can be equal to  $1, 2, \dots, n - 1$ . Thus, up to permutation of the cells, there are  $n - 1$  such networks.  $\square$

Denote by  $\mathbf{Z}_n$  the cyclic subgroup of  $\mathbf{S}_n$  generated by the  $n$ -cycle permutation  $\pi_n = (12 \dots n)$ . Define the following sets

$$\mathbf{Z}_n G = \{ \pi_n^j G : j = 0, 1, \dots, n - 1 \}, \quad \mathbf{Z}_n A_G = \left\{ P_{\pi_n}^{-1} A_G P_{\pi_n} : j = 0, 1, \dots, n - 1 \right\}.$$

**Theorem 7.5.** *Given  $n \in \mathbb{N}$ , consider the  $n - 1$  feed-forward networks,  $F_1, F_2, \dots, F_{n-1}$ , with  $n - 1, n - 3, n - 4, \dots, 0$  length one tails, respectively, as in lemma 7.4. The  $n$ -cell network with  $n(n - 1)$  asymmetric inputs given by the union network*

$$\bigcup_{i=1}^{n-1} \mathbf{Z}_n F_i$$

*is a representative of the minimal class  $\text{Min}_{n(n-1),n}$ .*

**Proof.** Consider the  $n - 1$  feed-forward networks in the conditions of lemma 7.4,  $F_1, F_2, \dots, F_{n-1}$ , with  $n - 1, n - 2, n - 3, \dots, 1$  tails. Without loss of generality, we can consider that the cells in each  $F_i$  are enumerated such that the cell 1 receives a self-input, the cells  $2, \dots, n - i + 1$  receive an edge from cell 1 and the cells  $n - i + 2, \dots, n$ , when  $i > 1$ , receive an edge, respectively, from the cells  $n - i + 1, \dots, n - 1$ .

Following the construction given in the proof of theorem 6.1, consider the matrix  $B$  whose columns  $1 + (i - 1)n, \dots, n + (i - 1)n$  correspond to the matrices in the sets  $\mathbf{Z}_n A_{F_i}$ , for  $i = 1, \dots, n - 1$ , by row. We have that, the rows  $1 + (i - 1)n, \dots, n + (i - 1)n$ , for  $i = 1, \dots, n$ , of  $B$ , correspond to the inputs that cell  $i$  receives from cells  $1, \dots, n$ , respectively, in the networks of  $\mathbf{Z}_n F_i$  for  $i = 1, \dots, n - 1$ .

We have the following observations: among the networks in  $\mathbf{Z}_n F_i$ , for  $i = 1, \dots, n - 1$ , there is only one network,  $F_1$ , such that cell  $n$  receives its input from cell 1. Thus, there is one row of  $B$  with the entry in the first column equal to 1 and all the other entries equal to 0. Using the permutations in  $\mathbf{Z}_n$ , there is one row of  $B$  with the entry in column  $k$  equal to 1 and all the other entries equal to 0, for  $k = 2, \dots, n$ . Among the networks in  $\mathbf{Z}_n F_i$ , for  $i = 1, \dots, n - 1$ , there are only two networks,  $F_1$  and  $F_2$ , such that cell  $n - 1$  receives its input from cell 1. Thus, there is one row of  $B$  with the entries in columns 1 and  $n + 1$  equal to 1 and all the other entries equal to 0. Using the permutations in  $\mathbf{Z}_n$ , for  $k = 2, \dots, n$ , there is one row of  $B$  with the entries in columns  $k$  and  $(k + n)$  equal to 1 and all the other entries equal to 0. This reasoning applies recursively, until cell 3. Among the networks in  $\mathbf{Z}_n F_i$ , for  $i = 1, \dots, n - 1$ , there are only  $n - 2$  networks,  $F_i$ ,  $i = 1, \dots, n - 2$ , such that cell 3 receives its input from cell 1. Thus,



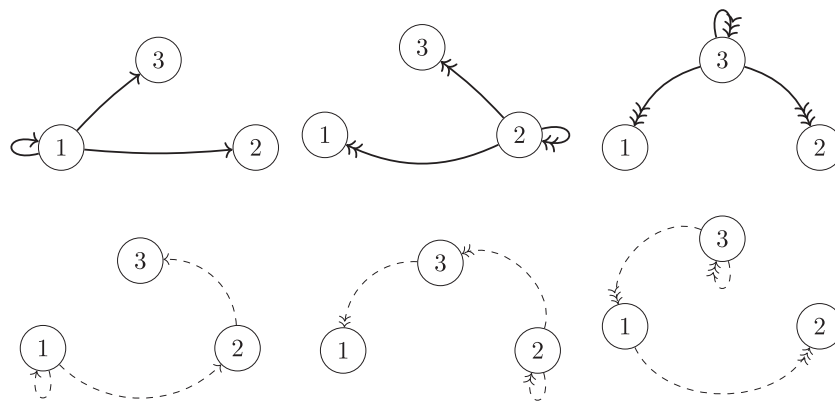

**Figure 3.** The networks  $C_1, C_2, C_3, D_1, D_3, D_5$  from table 2 whose union represent a minimal network in the class  $\text{Min}_{6,3}$ .

there is one row of  $B$  with the entries in columns  $1 + (i - 1)n$ , for  $i = 1, \dots, n - 2$ , equal to 1 and all the other entries equal to 0. Using the permutations in  $\mathbf{Z}_n$ , for each  $k = 2, \dots, n$ , there is one row of  $B$  with the entries in the columns  $k + (i - 1)n$ , for  $i = 1, \dots, n - 2$ , equal to 1 and all the other entries equal to 0. Finally, for the cell 1, we have that, among the networks in  $\mathbf{Z}_n F_i$ , for  $i = 1, \dots, n - 1$ , there are only  $n - 1$  networks,  $F_i$ ,  $i = 1, \dots, n - 1$ , such that cell 1 has a self-loop. Thus, there is one row of  $B$  with the entries in columns  $1 + (i - 1)n$ , for  $i = 1, \dots, n - 1$ , equal to 1 and all the other entries equal to 0. Using the permutations in  $\mathbf{Z}_n$ , for each  $k = 2, \dots, n$ , there is one row of  $B$  with the entries in the columns  $k + (i - 1)n$ , for  $i = 1, \dots, n - 1$ , equal to 1 and all the other entries equal to 0.

Taking the above observations into account, we conclude that there is a permutation of the rows of matrix  $B$  such that  $B$  is row-equivalent to a matrix with the following lower triangular block form:

$$\begin{bmatrix} \text{Id}_n & 0 & 0 & \dots & 0 \\ \text{Id}_n & \text{Id}_n & 0 & \dots & 0 \\ \dots & \dots & \dots & \dots & \dots \\ \text{Id}_n & \text{Id}_n & \text{Id}_n & \dots & \text{Id}_n \\ \text{Id}_n & * & * & \dots & * \end{bmatrix}$$

It follows that the matrix  $B$  has rank  $(n - 1)n$  and, thus, that the  $(n - 1)n$  matrices in  $\mathbf{Z}_n A_{F_i}$ , for  $i = 1, \dots, n - 1$ , are linearly independent. We conclude that the network given by the union of networks,  $\bigcup_{i=1}^{n-1} \mathbf{Z}_n F_i$ , is a representative of the minimal class  $\text{Min}_{n(n-1),n}$ .  $\square$

In the next example, we illustrate theorem 7.5 when  $n$  is equal to 3.

**Example 7.6.** Up to permutation of the cells, there are two three-cell feed-forward networks with one input, one having two tails of length one each and the other having just one tail with length two. See networks  $C \equiv F_1$  and  $D \equiv F_2$ , respectively, in table 1. Consider, also, the networks in the sets  $\mathbf{Z}_3 F_1 = \{C_1, C_2, C_3\}$  and  $\mathbf{Z}_3 F_2 = \{D_1, D_3, D_5\}$ , where the networks  $C_i$  and  $D_j$  appear in table 2. By theorem 7.5, the three-cell network with 6 asymmetric inputs given by the union of the networks in  $\mathbf{Z}_3 F_1 \cup \mathbf{Z}_3 F_2$  (see figure 3) is a representative of the minimal class  $\text{Min}_{6,3}$  (see figure 4).

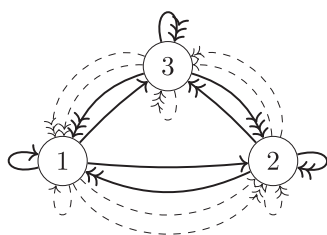

Figure 4. A representative of the minimal class  $\text{Min}_{6,3}$ .

**Remark 7.7.** For an integer  $n \geq 2$ , consider the  $n - 1$  feed-forward networks,  $F_1, F_2, \dots, F_{n-1}$ , with  $n - 1, n - 3, n - 4, \dots, 0$  length one tails, respectively, as in lemma 7.4. We remark that, for each  $k \leq n(n - 1)$ , the  $\binom{n(n - 1)}{k}$  networks with  $k$  asymmetric inputs defined by the union of the possible combinations of  $k$  networks in the set  $\{Z_n F_i : i = 1, \dots, n - 1\}$  are minimal networks representing ODE-classes. However, they can represent the same ODE-classes. For example, the minimal networks  $F_1$  and  $\pi_n F_1$  represent the same ODE-class. Therefore the number of distinct ODE-classes in  $\text{Min}_{1,n}$  given by those feed-forward networks is  $n - 1$ .

Nevertheless, we believe that the number of distinct classes in  $\text{Min}_{k,n}$  can be lower bounded by the number of  $k$ -combinations from  $n(n - 1)$  elements. In the next section, we prove that this lower bound is valid when  $k = 1$ .

### 8. More on $n$ -cell networks with one asymmetric input

Observe that for  $n = 3$  and  $n = 2$ , the number of distinct ODE-classes of the network set  $\text{Min}_{1,n}$  is equal to  $n(n - 1)$ . However, this is not true for  $n \geq 4$ . For example, from the results obtained by [11], we have that, up to permutation of cells, the set  $\text{Min}_{1,4}$  contains 18 networks and  $n(n - 1) = 12$  when  $n = 4$ . More generally, from the results of [11], we have that the number of distinct ODE-classes in  $\text{Min}_{1,n}$  increases quite fast with  $n$  and it is bigger than  $n(n - 1)$  for  $n \geq 4$ . We present below an algorithm that provides  $n(n - 1)$  networks belonging to  $n(n - 1)$  distinct ODE-classes in  $\text{Min}_{1,n}$  constructed from networks in distinct ODE-classes in  $\text{Min}_{1,l}$  for  $l < n$ .

By explicit computation, we can see that  $\text{Min}_{1,1}$  has no networks and  $\text{Min}_{1,2}$  has two ODE-distinct networks. Also, from table 1, we know that  $\text{Min}_{1,3}$  has six distinct ODE-classes of networks. We describe now explicitly some of the distinct ODE-classes of  $\text{Min}_{1,n}$ , for  $n > 3$ .

**Algorithm 8.1.** *Input:* a representative network  $G$  of an ODE-class in  $\text{Min}_{1,n-1}$  with adjacency matrix  $A_G$ , where  $n > 3$  is an integer. Let  $k$  be the number of cells of the largest cycle of the network.

*Output:* a representative network  $\tilde{G}$  with adjacency matrix  $\tilde{A}_{\tilde{G}}$  of an ODE-class in  $\text{Min}_{1,n}$  where  $k + 1$  is the number of cells of the largest cycle of the network.

- (a) Choose a representative network  $G \in \text{Min}_{1,n-1}$  and consider its adjacency matrix  $A_G$ . Let  $k$  be the number of cells of the largest cycle of the network.
- (b) Re-enumerate the cells if necessary so that the matrix  $A_G$  has the form:

$$A_G = \begin{bmatrix} C_k & 0 \\ B & D \end{bmatrix},$$

where  $C_k$  is the adjacency matrix of the  $k$ -cycle,  $B$  is a  $(n - 1 - k) \times k$  matrix and  $D$  is a  $(n - 1 - k) \times (n - 1 - k)$  matrix.

(c) Take the network with  $n$  cells by the following adjacency matrix

$$\tilde{A}_{\tilde{G}} = \begin{bmatrix} C_{k+1} & 0 \\ B & 0 \\ & & D \end{bmatrix},$$

where 0 is a column of zeros and  $C_{k+1}$  is the adjacency matrix of the  $(k + 1)$ -cycle.

(d) Output the network with adjacency matrix  $\tilde{A}_{\tilde{G}}$ .

**Proposition 8.2.** Algorithm 8.1 applied to a set of representatives of the distinct ODE-classes in  $\text{Min}_{1,n-1}$ , where  $n > 3$  is an integer, provides a set of ODE-distinct networks in  $\text{Min}_{1,n}$ .

**Proof.** We follow the notation of algorithm 8.1. Take two graphs  $G_1$  and  $G_2$  in  $\text{Min}_{1,n-1}$  with adjacency matrices  $A_1$  and  $A_2$  and consider the two networks in  $\text{Min}_{1,n}$  obtained as output in algorithm 8.1 with adjacency matrices  $\tilde{A}_1$  and  $\tilde{A}_2$ . We need to check that if  $\tilde{A}_1$  and  $\tilde{A}_2$  define ODE-equivalent networks then  $A_1$  and  $A_2$  define ODE-equivalent networks. Suppose that  $\tilde{A}_1$  and  $\tilde{A}_2$  define ODE-equivalent networks, i.e., there exists a permutation matrix  $P$  such that  $\tilde{A}_1 P = P \tilde{A}_2$ . Note that the largest cycle of both networks, as it stems from the (not necessarily unique) largest cycles of  $G_1, G_2$  enlarged by one cell, is unique and it consists of the same number of cells, say  $k + 1$ . In particular both adjacency matrices are of the form

$$\tilde{A}_i = \begin{bmatrix} C_{k+1} & 0 \\ B_i & 0 \\ & & D_i \end{bmatrix},$$

for  $i = 1, 2$  after re-enumeration of the cells. Then the permutation  $P$  must permute cells in the largest cycle with cells in the largest cycle and has the following form:

$$P = \begin{bmatrix} P_1 & 0 \\ 0 & P_2 \end{bmatrix},$$

where  $P_1$  is a  $(k + 1) \times (k + 1)$  matrix and  $P_2$  is a  $(n - 1 - k) \times (n - 1 - k)$  matrix. If  $\tilde{A}_1 P = P \tilde{A}_2$ , then  $C_{k+1} P_1 = P_1 C_{k+1}$ . By theorem 3.1.1 of [13], we know that  $P_1 = C_{k+1}^l$  for some integer  $0 \leq l \leq k$ .

Let  $\hat{P}$  be the permutation matrix given by

$$\hat{P} = \begin{bmatrix} C_k^l & 0 \\ 0 & P_2 \end{bmatrix}.$$

Next, we check that  $\tilde{A}_1 P = P \tilde{A}_2$  implies that  $A_1 \hat{P} = \hat{P} A_2$ . It is clear that  $C_k C_k^l = C_k^l C_k$  and  $D_1 P_2 = P_2 D_2$ . We need to see that  $B_1 C_k^l = P_2 B_2$ . It follows from  $\tilde{A}_1 P = P \tilde{A}_2$  that  $[B_1|0] C_{k+1}^l = P_2 [B_2|0]$  and

$$\begin{aligned} ([B_1|0])_{i(j-l+k+1)} &= \sum_{a=1}^{n-k-1} (P_2)_{ia} (B_2)_{aj} = (P_2 B_2)_{ij}, & 0 < j < l \\ 0 = ([B_1|0])_{ik+1} &= (P_2 B_2)_{ij}, & j = l \\ ([B_1|0])_{i(j-l)} &= \sum_{a=1}^{n-k-1} (P_2)_{ia} (B_2)_{aj} = (P_2 B_2)_{ij}, & l < j < k + 1 \\ ([B_1|0])_{i(k+1-l)} &= ([B_2|0])_{ik+1} = 0, & j = k + 1 \end{aligned}$$



**Table 10.** Six ODE-distinct four-cell networks with one input which are minimal build from the six ODE-distinct three-cell minimal networks with one input.

Three-cell network	Four-cell network	Three-cell network	Four-cell network

where  $|0$  is a column of zeros and  $1 \leq i \leq n - k$ . Then  $[B_1|0] = [X|0|Y|0]$  and  $[P_2B_2|0] = P_2[B_2|0] = [Y|0|X|0]$ , where  $X$  is a  $(n - k) \times (k - l)$  matrix and  $Y$  is a  $(n - k) \times (l - 1)$  matrix. Thus  $P_2B_2 = [Y|0|X] = B_1C_k^l$ .  $\square$

**Example 8.3.** Table 10 illustrates the application of algorithm 8.1 to a set of ODE-distinct networks in  $\text{Min}_{1,3}$  (taken from table 1) by increasing for each network the largest cycle by one cell, obtaining six ODE-distinct networks in  $\text{Min}_{1,4}$ .

**Algorithm 8.4.** *Input:* the feed-forward networks  $F_1$ , with  $n - 1$  cells and only one tail with length  $n - 2$ , and  $F_2$ , with  $n - 2$  cells and only one tail with length  $n - 3$ , respectively, where  $n > 3$  is a positive integer.

*Output:*  $2(n - 1)$  ODE-distinct feed-forward networks in  $\text{Min}_{1,n}$ .

- (a) Taking the feed-forward network  $F_1$  with  $n - 1$  cells, we add one new cell which receives a connection from the cells in  $F_1$ . There are  $n - 1$  different possible connection, one for each cell in  $F_1$ .
- (b) Taking the feed-forward network  $F_2$  with  $n - 2$  cells, we add two new cells which receive a connection from the same cell in  $F_2$ , except the cell in  $F_2$  without outgoing edges. There are  $n - 3$  different possible connections, one for each cell in  $F_2$  minus one.
- (c) Taking the feed-forward network  $F_1$  with  $n - 1$  cells, we add one new cell with a self-loop. Taking the feed-forward network  $F_2$  with  $n - 2$  cells, we add two new cells with a self-loop.



**Table 11.** Six ODE-distinct four-cell networks with one input which are minimal build from a three-cell and two-cell minimal feed-forward networks with one input.

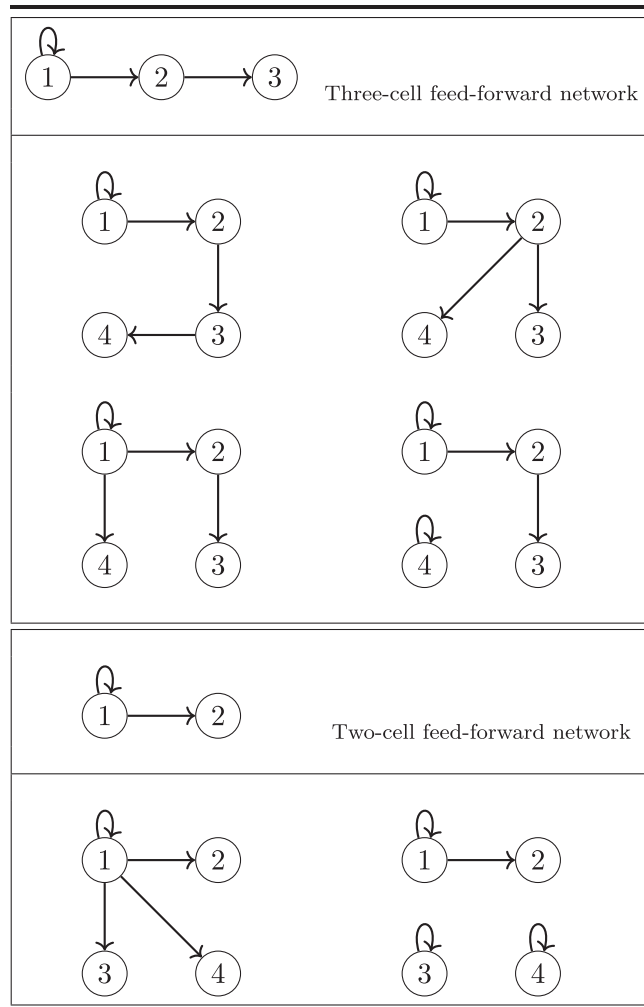

In algorithm 8.4, we provide  $n - 1 + n - 3 + 2 = 2(n - 1)$  feed-forward networks in  $\text{Min}_{1,n}$ , where  $n > 3$  is a positive integer. Trivially, we have that:

**Proposition 8.5.** *The  $2(n - 1)$  feed-forward networks outputted from algorithm 8.4, where  $n > 3$  is a positive integer, are ODE-distinct.*

**Example 8.6.** Table 11 illustrates the construction given in algorithm 8.4 for the case  $n = 4$  providing six ODE-distinct 4-cell networks in  $\text{Min}_{1,4}$  which are feed-forward.

**Theorem 8.7.** *Let  $n$  be a positive integer. The difference between the number of distinct ODE-classes in  $\text{Min}_{1,n}$  and in  $\text{Min}_{1,n-1}$  is at least  $2(n - 1)$ . Furthermore, the number of distinct ODE-classes in  $\text{Min}_{1,n}$  is at least  $n(n - 1)$ .*

**Proof.** Recall that  $\text{Min}_{1,1}$  has no networks,  $\text{Min}_{1,2}$  has two ODE-distinct networks, and that from table 1, we see that  $\text{Min}_{1,3}$  has six distinct ODE-classes of networks. So both assertions are true for  $n \leq 3$ . Assume now that  $n > 3$ . From algorithm 8.1 and proposition 8.2, we obtain ODE-distinct networks in  $\text{Min}_{1,n}$  from ODE-distinct networks in  $\text{Min}_{1,n-1}$ . From algorithm 8.4 and proposition 8.5, we obtain  $2(n-1)$  ODE-distinct feed-forward networks in  $\text{Min}_{1,n}$ . As the feed-forward networks are not ODE-equivalent to those networks obtained from extending the largest cycle because the largest cycle of the networks has different dimension, we have proved that the difference of the number of distinct ODE-classes between  $\text{Min}_{1,n}$  and  $\text{Min}_{1,n-1}$  is at least  $2(n-1)$  for  $n > 1$ .

By induction, we assume that the number of distinct ODE-classes in  $\text{Min}_{1,n-1}$  is greater than  $(n-1)(n-2)$  and using the previous claim we see that the number of distinct ODE-classes in  $\text{Min}_{1,n}$  is greater than  $n(n-1)$ . Thus, the second part of the theorem follows.  $\square$

## 9. Final conclusions

In this work, we prove that the set  $\text{Min}_{k,n}$  of minimal  $n$ -cell networks with  $k$  asymmetric inputs is empty for  $k > n(n-1)$  and that there is a unique ODE-class in  $\text{Min}_{n(n-1),n}$ . Note that the minimal representative of the unique ODE-class in  $\text{Min}_{n(n-1),n}$  obtained in theorem 7.5 is given by the union of  $n(n-1)$  networks in  $\text{Min}_{1,n}$  from solely  $(n-1)$  distinct ODE-classes. Nevertheless, as we have illustrated for the case of networks with three and four cells, it is natural to expect that there exists a minimal representative of  $\text{Min}_{n(n-1),n}$  such that each asymmetric input corresponds to a different ODE-class in  $\text{Min}_{1,n}$ . We recall that a network with  $k$  asymmetric inputs is the union of  $k$  networks with one (asymmetric) input.

Moreover, we conjecture that the union of every subset of  $k$  such networks, with  $k < n(n-1)$ , will correspond to a minimal representative of a distinct ODE-class for the networks with  $k$  asymmetric inputs. Therefore, we conjecture that the binomial coefficient, below, is a lower bound for the number of distinct ODE-classes in  $\text{Min}_{k,n}$ :

$$\binom{n(n-1)}{k} = \frac{(n(n-1))!}{k!(n(n-1)-k)!}, \quad k < n(n-1).$$

Nevertheless, we describe two algorithms to construct at least  $n(n-1)$  distinct ODE-classes with one input and  $n$  cells. Therefore, the conjecture above holds for  $k = 1$ . It also holds trivially for  $k = 0$  and  $k = n(n-1)$ . We believe that the algorithms presented here can be generalized for bigger numbers of asymmetric inputs. Since these algorithms use the minimal representative networks with less cells, we hope that those generalized algorithms lead to a proof of the conjecture for  $k \leq n(n-1)/2$ . For the values of  $k$  on the second half, we conjecture that the number of ODE-classes is symmetric. Specifically, we conjecture that the number of ODE-classes in  $\text{Min}_{k,n}$  is equal to the number of ODE-classes in  $\text{Min}_{n(n-1)-k,n}$ . The orthogonality of subspaces in the space generated by all adjacency matrices can lead to a proof of this conjecture. Note that the binomial coefficient is strictly lower than the number of ODE-classes in the cases  $(n, k) = (3, 2)$  and  $(n, k) = (4, 1)$ .

## Acknowledgments

We thank the referees for many helpful suggestions contributing to improve the exposition and clarity of this work. The authors were partially supported by CMUP (UID/MAT/00144/2019),

which is funded by FCT with national (MCTES) and European structural funds through the programs FEDER, under the partnership Agreement PT2020. The third author, PS, was supported by Grant BEETHOVEN2 of the National Science Centre, Poland, No. 2016/23/G/ST1/04081.

## ORCID iDs

Manuela Aguiar  <https://orcid.org/0000-0003-3508-0509>

Ana Dias  <https://orcid.org/0000-0002-8852-6175>

Pedro Soares  <https://orcid.org/0000-0003-1869-7662>

## References

- [1] Agarwal N and Field M 2010 Dynamical equivalence of networks of coupled dynamical systems: I. Asymmetric inputs *Nonlinearity* **23** 1245–68
- [2] Agarwal N and Field M 2010 Dynamical equivalence of networks of coupled dynamical systems: II. General case *Nonlinearity* **23** 1269–89
- [3] Aguiar M A D 2018 Networks with asymmetric inputs: lattice of synchrony subspaces *Nonlinearity* **31** 3847–79
- [4] Aguiar M, Ashwin P, Dias A and Field M 2011 Dynamics of coupled cell networks: synchrony, heteroclinic cycles and inflation *J. Nonlinear Sci.* **21** 271–323
- [5] Aguiar M A D, Dias A P S and Ferreira F 2017 Patterns of synchrony for feed-forward and auto-regulation feed-forward neural networks *Chaos* **27** 013103
- [6] Aguiar M A D, Dias A and Field M 2019 Feedforward networks: adaptation, feedback, and synchrony *J. Nonlinear Sci.* **29** 1129–64
- [7] Aguiar M A D, Dias A P S and Soares P 2020 Characterization of fundamental networks *Proc. R. Soc. Edinburgh A* **150** 453–74
- [8] Aguiar M A D and Dias A P S 2007 Minimal coupled cell networks *Nonlinearity* **20** 193–219
- [9] Aguiar M A D, Dias A P S and Soares P 2019 The steady-state lifting bifurcation problem associated with the valency on networks *Physica D* **390** 36–46
- [10] Aguiar M, Dias A and Soares P 2020 Steady-state bifurcations in three-cell networks with asymmetric inputs (arXiv:2005.12602v1)
- [11] Aldosray F and Stewart I 2005 Enumeration of coupled cell networks *Int. J. Bifurcation Chaos Appl. Sci. Eng.* **15** 2361–73
- [12] Chotchaisthit S 2014 Simple proof of determining all nonisomorphic monoids of order 3 *Appl. Math. Sci. (Ruse)* **8** 1261–9
- [13] Davis P J 1979 *Circulant Matrices (Pure and Applied Mathematics)* (New York: Wiley)
- [14] Dias A P S and Stewart I 2005 Linear equivalence and ODE-equivalence for coupled cell networks *Nonlinearity* **18** 1003–20
- [15] Field M 2004 Combinatorial dynamics *Dyn. Syst.* **19** 217–43
- [16] Golubitsky M, Stewart I and Török A 2005 Patterns of synchrony in coupled cell networks with multiple arrows *SIAM J. Appl. Dyn. Syst.* **4** 78–100
- [17] Leite M C A and Golubitsky M 2006 Homogeneous three-cell networks *Nonlinearity* **19** 2313–63
- [18] Milo R, Shen-Orr S, Itzkovitz S, Kashtan N, Chklovskii D and Alon U 2002 Network motifs: simple building blocks of complex networks *Science* **298** 824–7
- [19] Nijholt E, Rink B and Sanders J 2016 Graph fibrations and symmetries of network dynamics *J. Differ. Equ.* **261** 4861–96
- [20] Nijholt E, Rink B and Sanders J 2017 Projection blocks in homogeneous coupled cell networks *Dyn. Syst.* **32** 164–86
- [21] Nijholt E, Rink B and Sanders J 2017 Center manifolds of coupled cell networks *SIAM J. Math. Anal.* **49** 4117–48
- [22] Nijholt E, Rink B and Schwenker J 2019 Amplified steady state bifurcations in feedforward networks (arXiv:2105.02547)



- [23] Rink B W and Sanders J A 2013 Amplified Hopf bifurcations in feed-forward networks *SIAM J. Appl. Dyn. Syst.* **12** 1135–57
- [24] Rink B and Sanders J 2014 Coupled cell networks and their hidden symmetries *SIAM J. Math. Anal.* **46** 1577–609
- [25] Rink B and Sanders J 2015 Coupled cell networks: semigroups, Lie algebras and normal forms *Trans. Am. Math. Soc.* **367** 3509–48
- [26] Schwenker S 2019 Genericity in network dynamics *PhD Thesis* Universität Hamburg
- [27] Soares P 2018 The lifting bifurcation problem on feed-forward networks *Nonlinearity* **31** 5500–35
- [28] Stewart I, Golubitsky M and Pivato M 2003 Symmetry groupoids and patterns of synchrony in coupled cell networks *SIAM J. Appl. Dyn. Syst.* **2** 609–46