

# Vibration Surveillance During Milling Flexible Details with the Use of Active Optimal Control

Marek Chodnicki<sup>1</sup>, Krzysztof J. Kaliński<sup>2</sup> and Marek A. Galewski<sup>3</sup>

*Chair of Mechanics and Mechatronics, Gdansk University of Technology, Narutowicza Str. 11/12, 80-233 Gdansk, Poland*

*<sup>1</sup>marek@chodnicki.pl; <sup>2</sup>kkalinsk@o2.pl; <sup>3</sup>marg@mech.pg.gda.pl*

## ABSTRACT

The main goal of modern machining operations is to achieve increasingly better performance. High Speed Machining and/or High Performance Cutting, despite a lot of advantages, have also some drawbacks, for example, a possibility of losing stability and development of self-excited chatter vibration. This paper presents an approach of vibration surveillance during high speed milling with a use of active optimal control. Non-stationary model of the milling process is described with the use of convention of the discrete hybrid system, and the problem of optimal control at energy performance index is defined and resolved. Numerous computer simulations disclosed efficiency of the surveillance by the active optimal control of flexible workpiece vibration. The performed real experiments of the milling process support the meaning of the method of vibration surveillance.

## 1. INTRODUCTION

Contour milling of the workpiece having spatially complex surfaces is often occurred in case of modern machining centres Fiedler [1]. Technological justification results from the need of precise execution of complex geometric configurations (e.g. turbine blades, rotors, dies, inaccessible hollows, injection moulds, thin-walled elements). Making such devices is an important task from the point of view of the expectations of food industry, machine engineering, automotive plants and aviation. Also the shape milling process features variable cutting geometry. The complexity of the product and its technology, as well as high costs of usual finishing operations require that the milling treatment process is thought to be final. The main goal of modern machining operations is to achieve their better performance. Highly efficient cutting is described as High Speed Machining (HSM). Thanks to a global trend of increasing cutting speed above 1000 m/min and feed rate over 100 m/min, one can get high performance of the process at much lower allowance Sutter [2]. The latter is not without significance from a point of view of the reduction of cutting forces Özel [3]. Almost total elimination of the coolant Nouari [4] makes the HSM more ecological.

Dynamic phenomenon of considerable importance in the process of a slender tool milling is tool-workpiece relative vibration. In certain circumstances the development of this vibration can lead to system instability, and then – to the kind of self-excited vibration, which is called chatter Olgac [5]. The risk of the latter can greatly reduce processing efficiency, worsen the machined surface, as well as cause damage of tools and workpieces. The appearance of abnormal chatter vibration worsens surface finish, decreases tool life rapidly and even results in tool destruction. However, only some papers investigate the relationship between level of controlled vibration and machining accuracy as well as – durability of the edges Kwon [6].

The problem of prevention of chatter vibration has been addressed in various approaches referred to the tool-workpiece vibration surveillance in the case of HSM Mane [7] and Badiaga [8]. The methodology of vibration surveillance at the spindle speed changes was applied successfully for the high-speed slender milling of rigid

## Vibration Surveillance During Milling Flexible Details with the Use of Active Optimal Control

workpieces made of various materials Kaliński [9]. It was confirmed the efficiency of the modified method of vibration surveillance in the potentially unstable areas of spindle speed, in the stability lobes diagram Kaliński [10]. Vibration surveillance using the programs of variable spindle speed, however, is ineffective in the case of milling flexible details Kaliński [11]. Also, the efficiency of tool-flexible workpiece vibration surveillance by matching the spindle speed to the optimal phase shift, was confirmed with success Kaliński [12]. Just the same, the proposed method of surveillance does not give the possibility to operate within the full range of spindle speed. In turn, the system of vibration surveillance, which is based on the actuators mounted directly on the flexible workpiece, due to the ability of generating the relevant vertical forces, has real practical meaning Kaliński [13]. Therefore, this paper presents an approach of vibration surveillance during high speed milling with the use of such active optimal control.

### 2. DYNAMIC CHARACTERISTICS OF THE CUTTING PROCESS

A common mechanistic model, which describes the milling dynamics, is proportional model Kaliński [10,14] and Jayaram [15], in which the cutting forces depend proportionally on the cutting layer thickness, and the cutting depth; both of them vary in time. It is assumed that the resultant cutting force lies in the orthogonal plane. According to the directions of force components, we separate Kaliński [10,13,16] cutting force acting along nominal cutting velocity (Fig. 1):

$$F_{y1}(t) = \begin{cases} k_{dl}a(t)[h_{dl}(t) - \Delta h_l(t) + \Delta h_l(t - \tau_l)] & \text{for } h_{dl}(t) - \Delta h_l(t) + \Delta h_l(t - \tau_l) > 0, \\ 0 & \text{for } h_{dl}(t) - \Delta h_l(t) + \Delta h_l(t - \tau_l) \leq 0, \end{cases} \quad (1)$$

thrust force acting along an instantaneous change in cutting layer thickness:

$$F_{y2}(t) = \begin{cases} \mu_l k_{dl} a(t)[h_{dl}(t) - \Delta h_l(t) + \Delta h_l(t - \tau_l)] & \text{for } h_{dl}(t) - \Delta h_l(t) + \Delta h_l(t - \tau_l) > 0, \\ 0 & \text{for } h_{dl}(t) - \Delta h_l(t) + \Delta h_l(t - \tau_l) \leq 0, \end{cases} \quad (2)$$

and the third force component:

$$F_{y3}(t) = 0, \quad (3)$$

where:

$k_{dl}$  – average dynamic specific cutting pressure,

$a(t)$  – instantaneous cutting depth,

$h_{dl}(t)$  – desired cutting layer thickness;  $h_{dl}(t) \cong f_z \cdot \cos \varphi_l(t)$ ,

$f_z$  – feed per edge;  $f_z = v_f / (n z)$ ,

$n$  – spindle speed,

$v_f$  – feed speed,

$z$  – number of cutting edges,

$h_l(t)$  – instantaneous cutting layer thickness;  $h_l(t) = h_{dl}(t) - \Delta h_l(t) + \Delta h_l(t - \tau_l)$ ,

$\Delta h_l(\cdot)$  – dynamic change in cutting layer thickness,

$\mu_l$  – cutting force ratio,

$\tau_l$  – time-delay.

The described method in this article has a general meaning. However for the purpose of its experimental verification, the developed cutting force model is applied to ball-end-milling of one-side-supported rectangular plate.

The number of degrees of freedom of non-stationary calculation model of the milling process can be as high as a few hundred thousands. Thus it is not a model that can be easily exploited for the purposes of the implemented on-line computer

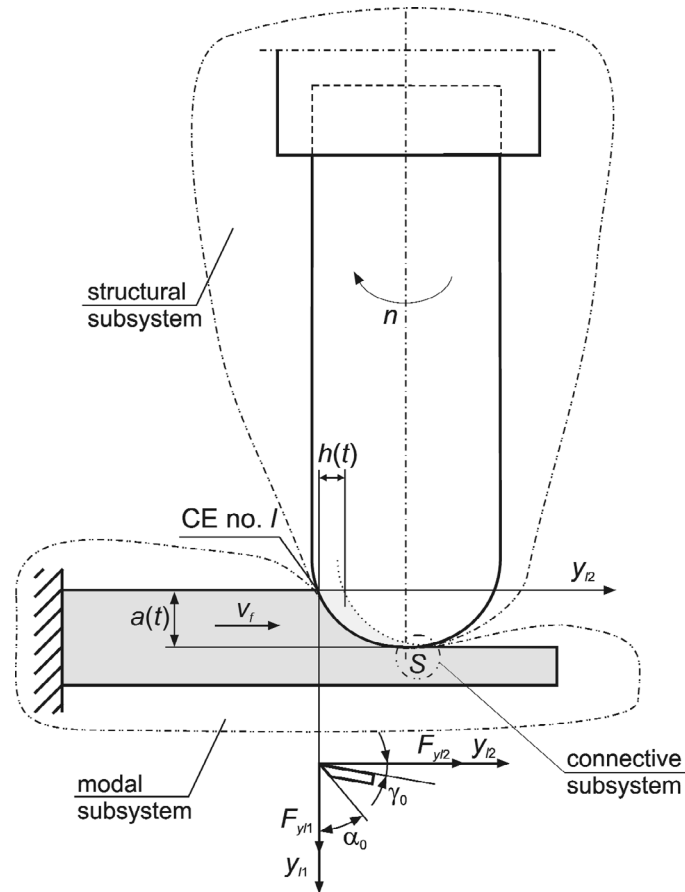

Figure 1. Scheme of a slender ball end milling of one-side-supported flexible workpiece

simulation. Therefore, as a follow-up of modelling the milling process, hybrid system is obtained Kaliński [13,16], in which are separated following subsystems: modal, structural and connective (Fig.1). They respectively represent: stationary model of a flexible plate (workpiece), non-stationary model of a rotating tool (in our case, ball-end mill) and conventional contact point between tool and workpiece Kaliński [16, 17].

### 3. DYNAMICS OF NON-STATIONARY CONTROLLED SYSTEM IN HYBRID CO-ORDINATES

Matrix equation of the controlled non-stationary dynamic system in hybrid co-ordinates has much lower rank than the appropriate one described in generalised co-ordinates. The equation has the following form Kaliński [16]:

$$\mathbf{M}_{\xi} \ddot{\xi} + \mathbf{L}_{\xi} \dot{\xi} + \mathbf{K}_{\xi} \xi = \mathbf{f}_{\xi} + \mathbf{B}_{u\xi} \mathbf{u}, \quad (4)$$

where:

$$\mathbf{M}_{\xi} = \begin{bmatrix} \mathbf{M} & \mathbf{0} \\ \mathbf{0} & \mathbf{I} \end{bmatrix} \text{ – mass matrix of the hybrid system,}$$

$$\mathbf{L}_{\xi} = \begin{bmatrix} \mathbf{L} & \mathbf{0} \\ \mathbf{0} & 2\mathbf{Z}\mathbf{\Omega} \end{bmatrix} \text{ – damping matrix of the hybrid system,}$$

$$\mathbf{K}_{\xi} = \begin{bmatrix} \mathbf{K} + \sum_{l=1}^{i_j} \mathbf{T}_l^T(t) \mathbf{D}_{Pl}(t) \mathbf{T}_l(t) & - \sum_{l=1}^{i_j} \mathbf{T}_l^T(t) \mathbf{D}_{Pl}(t) \mathbf{W}_{ml}(t) \\ - \sum_{l=1}^{i_j} \mathbf{W}_{ml}^T(t) \mathbf{D}_{Pl}(t) \mathbf{T}_l(t) & \mathbf{\Omega}^2 + \sum_{l=1}^{i_j} \mathbf{W}_{ml}^T(t) \mathbf{D}_{Pl}(t) \mathbf{W}_{ml}(t) \end{bmatrix} \text{ – stiffness matrix of the hybrid system,}$$

## Vibration Surveillance During Milling Flexible Details with the Use of Active Optimal Control

$$\mathbf{B}_{u\xi} = \begin{bmatrix} \mathbf{B}_{uq} \\ \Psi^T \mathbf{B}_u \end{bmatrix} \text{ – control matrix of the hybrid system,}$$

$$\mathbf{f}_{\xi} = \begin{bmatrix} \mathbf{f}_q \\ \Psi^T \mathbf{f} \end{bmatrix} \text{ – vector of “hybrid” forces,}$$

$$\xi = \begin{bmatrix} \mathbf{q} \\ \mathbf{a} \end{bmatrix} \text{ – vector of hybrid co-ordinates of the whole system,}$$

$\mathbf{M}, \mathbf{L}, \mathbf{K}$  – matrices of mass, damping and stiffness of the decoupled structural subsystem, i.e. the Euler-Bernoulli bar, which idealises rotating tool [16],

$\mathbf{a}$  – vector of modal co-ordinates of the modal subsystem,

$\mathbf{q}$  – vector of generalised co-ordinates of the structural subsystem,

$\mathbf{T}_l(t)$  – transformation matrix of generalised displacements from co-ordinate system of the Euler-Bernoulli bar modelling cutting tool, to co-ordinate system  $y_{l1}, y_{l2}, y_{l3}$  of CE no.  $l$  Kaliński [10, 16],

$\mathbf{W}_{ml}(t)$  – matrix of constraints between displacements in the modal co-ordinates of the modal subsystem, and generalised displacements in co-ordinate system  $y_{l1}, y_{l2}, y_{l3}$  of CE no.  $l$  Kaliński [16],

$\mathbf{D}_{Pl}(t), \mathbf{D}_{Ol}(t)$  – matrices of proportional and delayed feedback of CE no.  $l$  Kaliński [10, 16],

$\mathbf{Z} = \text{diag}(\zeta_i)$  – matrix of dimensionless damping coefficients of the modal subsystem;  $i=1, \dots, \text{mod}$ ,

$\Psi = [\Psi_1 \dots \Psi_{\text{mod}}]$  – matrix of the considered normal modes of the modal subsystem, and it is the mass normalised;  $i=1, \dots, \text{mod}$ ,

$\Omega = \text{diag}(\omega_{0i})$  – matrix of the considered angular natural frequencies of the modal subsystem;  $i=1, \dots, \text{mod}$ . This is also called the modal stiffness matrix, and it is the mass normalised;

$\text{mod}$  – number of the considered normal modes of the modal subsystem,

$\mathbf{F}_l^0(t)$  – vector of the desired forces of CE no.  $l$  Kaliński [10, 16],

$\Delta \mathbf{w}_l(t-\tau_l)$  – vector of deflections of CE no.  $l$ , for time-instant  $t-\tau_l$  Kaliński [10, 16],

$i_l$  – number of „active” coupling elements Kaliński [10, 16],

$\mathbf{f}_q$  – vector of generalised forces of the structural subsystem,

$\mathbf{f}$  – vector of generalised forces of the modal subsystem,

$\mathbf{B}_{uq}$  – control matrix of the structural subsystem,

$\mathbf{B}_u$  – control matrix of the modal subsystem,

$\mathbf{u}$  – vector of control commands. The latter are additional forces generated by external actuators placed on the workpiece, in order to reduce its vibration.

Eqn. (4) states that in order to identify modal model of the flexible workpiece, matrix of normal modes  $\Psi$  and matrix of corresponding angular natural frequencies  $\Omega$  of the modal subsystem, need to be determined. Separating the modal subsystem from the whole non-stationary structure allows reducing the finite element model to a few modes whose number depends on the importance and necessity of choosing the modes for further analysis. As a result, the size of the model is remitted significantly.

### 4. OPTIMAL VIBRATION CONTROL IN HYBRID CO-ORDINATES

In case of the delayed closed-loop non-stationary system, the optimal control command can be achieved with the use of the energy performance index Kaliński [16]. Active optimal control allows us to:

- formulate the control problem in time domain and considering the minimum energy approach,

- develop effective algorithm of computer simulation,
- perform a surveillance of unsteady vibration of non-stationary systems,
- perform vibration surveillance of closed loop non-stationary systems,
- synthesise the optimal control system and real cutting process.

Energy performance index, which is defined in hybrid co-ordinates, considers changing with time kinetic, potential and control command's energy, with respect to trajectory of the desired motion (described by hybrid co-ordinates  $\xi$  and their time derivatives  $\dot{\xi}$ ). It has a form Kaliński [16]:

$$J(t) = \frac{1}{2}(\dot{\xi} - \dot{\bar{\xi}})^T \mathbf{Q}_{1\xi} \mathbf{M}_{\xi} (\dot{\xi} - \dot{\bar{\xi}}) + \frac{1}{2}(\xi - \bar{\xi})^T \mathbf{Q}_{2\xi} \mathbf{K}_{\xi} (\xi - \bar{\xi}) + \frac{1}{2} \mathbf{u}^T \mathbf{R} \mathbf{u} \quad (5)$$

where:

$\mathbf{Q}_{1\xi}$ ,  $\mathbf{Q}_{2\xi}$  – matrices of dimensionless weighing coefficients,

$\mathbf{R}$  – matrix of control efforts.

Let us express eqn. (4) in state co-ordinates, i.e.:

$$\dot{\mathbf{x}} = \mathbf{A}_{\xi} \mathbf{x} + \mathbf{D}_{\xi} \mathbf{z} + \mathbf{B}_{\xi} \mathbf{u} \quad (6)$$

where:

$\mathbf{x} = \begin{bmatrix} \dot{\xi}^T & \xi^T \end{bmatrix}^T$  – vector of state co-ordinates of the hybrid system,

$\mathbf{A}_{\xi} = \begin{bmatrix} -\mathbf{M}_{\xi}^{-1} \mathbf{L}_{\xi} & -\mathbf{M}_{\xi}^{-1} \mathbf{K}_{\xi} \\ \mathbf{I} & \mathbf{0} \end{bmatrix}$  – state matrix of the hybrid system,

$\mathbf{D}_{\xi} = \begin{bmatrix} \mathbf{M}_{\xi}^{-1} \\ \mathbf{0} \end{bmatrix}$  – disturbance matrix of the hybrid system,

$\mathbf{B}_{\xi} = \begin{bmatrix} \mathbf{M}_{\xi}^{-1} \mathbf{B}_{u\xi} \\ \mathbf{0} \end{bmatrix}$  – input matrix of the hybrid system,

$\mathbf{z} \equiv \mathbf{f}_{\xi}$  – vector of disturbances, i.e. all non-potential forces.

Eqn. (6) is resolved with the use of the state transition method Kaliński [16]. Thus the time-domain solution, at initial instant  $t_0$ , has a form:

$$\mathbf{x}(t) = \Phi_{\xi}(t, t_0) \mathbf{x}(t_0) + \int_{t_0}^t \Phi_{\xi}(t, \tau) [\mathbf{B}_{\xi}(\tau) \mathbf{u}(\tau) + \mathbf{D}_{\xi}(\tau) \mathbf{z}(\tau)] d\tau \quad (7)$$

where:

$\Phi_{\xi}(t, t_0)$  – fundamental matrix, which is solution to homogeneous differential equation  $\dot{\mathbf{x}} = \mathbf{A}_{\xi}(t) \mathbf{x}$ ,  $\mathbf{x}(t_0) = \mathbf{I}$ .

Optimal control command (also in hybrid co-ordinates) has been obtained after comparing variation of the energy performance index eqn. (5) to zero, that is to say:

$$\begin{aligned} \delta J(t) = & \frac{1}{2}(\dot{\xi} - \dot{\bar{\xi}})^T (\mathbf{Q}_{1\xi} \mathbf{M}_{\xi} + \mathbf{M}_{\xi}^T \mathbf{Q}_{1\xi}^T) \delta(\dot{\xi} - \dot{\bar{\xi}}) + \\ & + \frac{1}{2}(\xi - \bar{\xi})^T (\mathbf{Q}_{2\xi} \mathbf{K}_{\xi} + \mathbf{K}_{\xi}^T \mathbf{Q}_{2\xi}^T) \delta(\xi - \bar{\xi}) + \frac{1}{2} \mathbf{u}^T (\mathbf{R} + \mathbf{R}^T) \delta \mathbf{u} = 0, \end{aligned} \quad (8)$$

## Vibration Surveillance During Milling Flexible Details with the Use of Active Optimal Control

and considering variation of the expression (7):

$$\delta \mathbf{x} = \int_{t_0}^t \Phi_{\xi}(t, \tau) \mathbf{B}_{\xi}(\tau) \delta \mathbf{u}(\tau) d\tau = \int_{t_0}^t \Phi_{\xi}(t, \tau) \mathbf{B}_{\xi}(\tau) d\tau \delta \mathbf{u}. \quad (9)$$

Hence the optimal control command, which minimises energy performance index eqn. (5), has a form:

$$\mathbf{u} = -(\mathbf{R} + \mathbf{R}^T)^{-1} \int_{t_0}^t \mathbf{B}_{\xi}^T(\tau) \Phi_{\xi}^T(t, \tau) d\tau \left\{ \mathbf{T}_{1\xi}^T (\mathbf{M}_{\xi}^T \mathbf{Q}_{1\xi}^T + \mathbf{Q}_{1\Phi} \mathbf{M}_{\xi}) \left[ \dot{\xi} - \dot{\bar{\xi}} \right] + \right. \\ \left. + \mathbf{T}_{2\xi}^T (\mathbf{K}_{\xi}^T \mathbf{Q}_{2\xi}^T + \mathbf{Q}_{2\xi} \mathbf{K}_{\xi}) (\xi - \bar{\xi}) \right\}, \quad (10)$$

where matrices  $\mathbf{T}_{1\xi}$  and  $\mathbf{T}_{2\xi}$  allow us to make following matrix transformations:

$$\dot{\xi} = \underbrace{\begin{bmatrix} \mathbf{I} & \vdots & \mathbf{0} \end{bmatrix}}_{\mathbf{T}_{1\xi}} \mathbf{x} = \mathbf{T}_{1\xi} \mathbf{x}, \quad \xi = \underbrace{\begin{bmatrix} \mathbf{I} & \vdots & \mathbf{0} \end{bmatrix}}_{\mathbf{T}_{2\xi}} \mathbf{x} = \mathbf{T}_{2\xi} \mathbf{x}. \quad (11)$$

A very important and thus far unresolved problem is how to determine values of the components of matrices  $\mathbf{Q}_{1\xi}$ ,  $\mathbf{Q}_{2\xi}$ ,  $\mathbf{R}$ . Casual choice of these values ought to be avoided, because the surveillance effect depends on them. It is difficult to find effective method for the searching the large-dimension parameters space. A good indication is to use computer simulation methods Kaliński [16].

### 5. COMPUTER SIMULATIONS

The selected workpieces are flexible plates, dimensions  $140 \times 50 \times 5$  mm, made of bronze CC331G (BA1032), aluminium alloy EN AW-6101A (PA38) and steel C45 (45). In every case they are fixed in a special holder placed on the table of the Quaser MV204IU/15 milling machine.

Computer models of the flexible plates were created using the finite element method (FEM). The models, with and without the attached accelerometer, were prepared with a use of the *T-Systems Medina* as postprocessor. Natural frequencies and corresponding normal modes were calculated using the *Permas* solver. In order to illustrate some normal modes, the *FEGraph* pre-processor was applied (Fig.2).

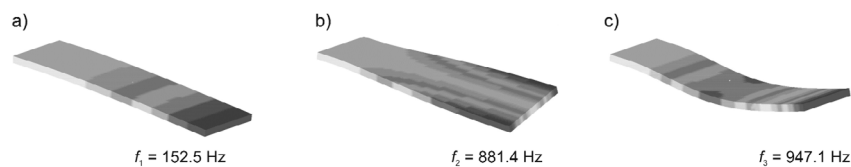

Figure 2. First three natural frequencies and normal modes of the modelled flexible plate

Good agreement (the Modal Assurance Criterion value greater than 0.7 Kaliński [16] and Maia [18]) between the results of calculation and experimental investigation (the modal tests were performed as well) allows us to use such computer model for a future analysis of the milling process, e.g. for the aim of active vibration surveillance.

For the purposes of simulations, original computer software is implemented. It allows determining time and frequency response of displacement of the tool and the machined workpiece, for the selected path of the tool (Fig. 3). There are performed calculations, for the selected parameters of machining and the determined parameters of the modal model, i.e. Kaliński [16]:

- dimensionless damping coefficient of the workpiece  $\zeta$ ,



- average specific dynamic cutting pressure  $k_{dl}$ ,
- tilt angle between the mill axis and the normal line to the milled surface  $\kappa$ ,
- depth of cutting  $a_p$ ,
- spindle speed  $n$  [rev/min].

Appropriate values for the computer simulation parameters are considered (Table 1).

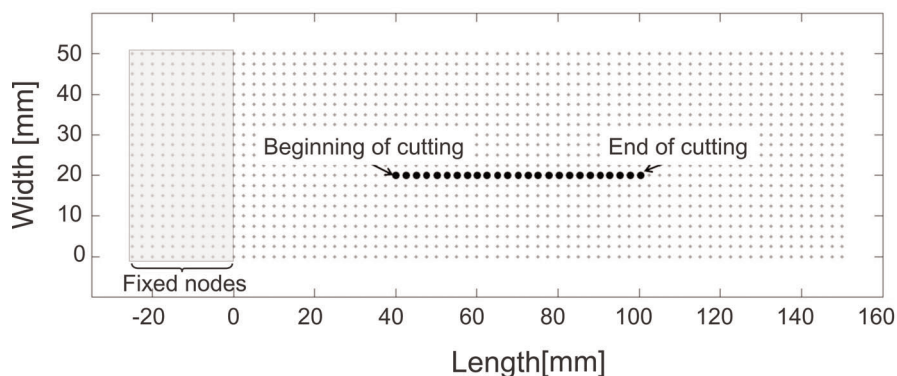

Figure 3. The selected path of the tool along the workpiece

**Table 1.**  
Machining parameters for simulation of the flexible workpiece hybrid model

Name	Symbol	Value	Unit
Number of cutting edges	$z$	2	-
Spindle speed	$n_0$	[4000, 6000, 8000, 9000, 10000, 12000, 14000, 16000, 18000, 20000]	rev/min
Cutting depth	$a_{pl}$	[0.1, 0.2, 0.3, 0.4]	mm
Tilt angle	$\kappa$	[0°, 15°, 30°]	-
Average dynamic specific cutting pressure	$k_{dl}$	[100, 200, 300]	daN/mm <sup>2</sup>
Feed per edge	$f_z$	0.1	mm
Cutting force ratio	$\mu_1$	0.3	
Tool mass	$m$	0.3	kg
Eccentricity – tool imbalance	$e$	0.5	mm
Dimensionless damping coefficient of the workpiece	$\zeta$	[0.005, 0.01, 0.02]	
First natural frequency of the workpiece	$f_{01}$	152.51	Hz

In order to assess the observed vibrations, root mean square (RMS) of the obtained time response is defined. Results of computer simulations confirmed efficiency of the method for the flexible workpiece vibration surveillance with a use of the active optimal control; the RMS values of the flexible plate vibration at instantaneous contact point of tool and workpiece, are significantly reduced under the active optimal control in all the cases. Exemplary results of computation are shown in Fig. 4, for  $\zeta = 0,005$ ,  $k_{dl} = 300$  daN/mm<sup>2</sup>,  $\kappa = 0^\circ$ , feed per edge  $f_z = 0,1$  mm. Existence of the active optimal control stabilises the milling process performance in a wide range of spindle speeds and much higher depths of cutting. Additionally, in Fig. 5 is illustrated a comparison of the results, for  $\kappa = 15^\circ$  and  $30^\circ$ . The latter allows an easy observation of a positive influence of increasing tilt angle on the surveillance efficiency. The greater the applied  $\kappa$  value, the smaller the vibration RMS value is.

## Vibration Surveillance During Milling Flexible Details with the Use of Active Optimal Control

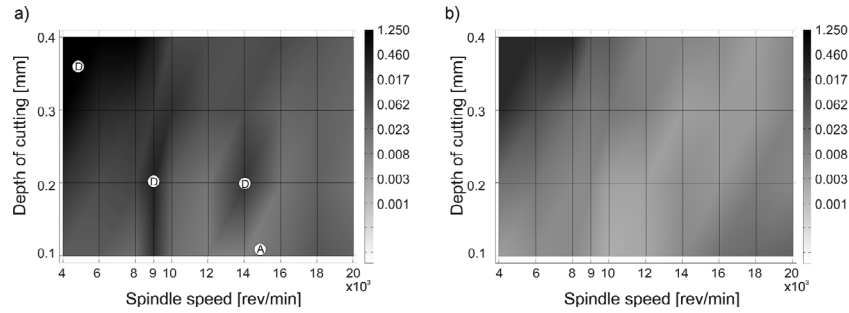

Figure 4. The RMS of vibration of the flexible plate. Dependence on cutting depth and spindle speed, a) without surveillance, A – stable cutting area, D – unstable cutting area, b) with surveillance

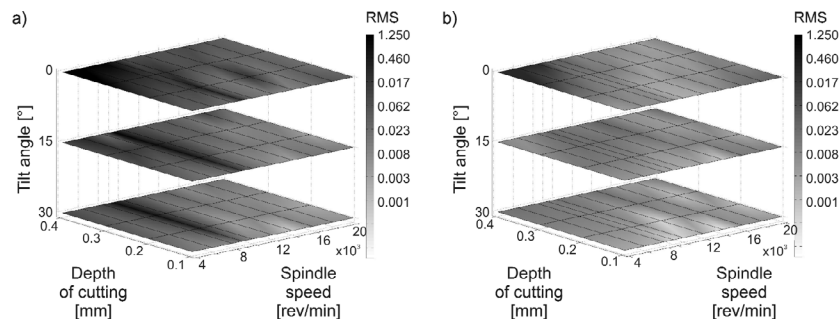

Figure 5. The RMS of vibration of the flexible plate. Dependence on cutting depth, spindle speed, and angle between the mill axis and the normal line to the surface, a) without surveillance, b) with surveillance

### 6. EXPERIMENTAL INVESTIGATION

In order to confirm the efficiency of vibration surveillance, suitable experimental stand, whose scheme is illustrated in Fig. 6, is built on the Quaser MV204IIU/15 milling machine. One accelerometer (ICP PCB 353B01) is mounted at the bottom, opposite to the manufactured surface, for a purpose of measuring the workpiece vibration. Piezoceramic bending plate actuator Noliac CMBP06 is affixed in a distance of 5 mm from the unsupported end of the CC331G bronze plate (dimensions 140×50×5 mm). In order to generate excitation force, small seismic mass 4.4 g is attached. Signal from the accelerometer is conditioned and acquired by the DAQ card installed in the real-time computer. Sampling frequency is set to 5 kHz. Control signal is passed to the actuator through the power amplifier.

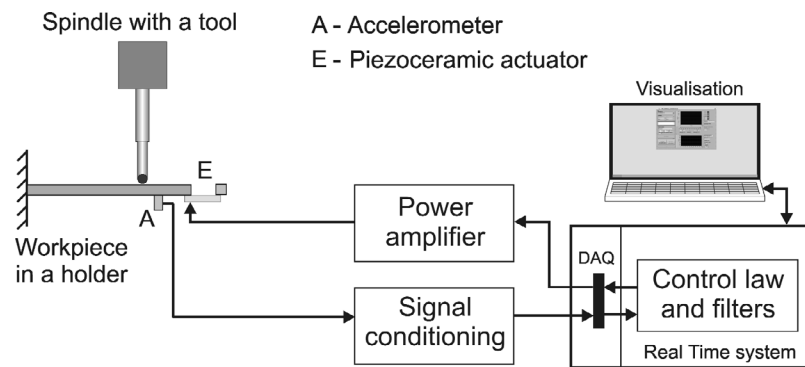

Figure 6. Scheme of measuring and control system

Machining depended on making several grooves on surface of the plate. Tilt angles of ball end mill were  $\kappa = 0^\circ$ ,  $15^\circ$  and  $30^\circ$ . Exemplary experimental results of the flexible plate milling, at spindle speed set to 9000 rev/min, feed speed – 180



mm/min (which refers to feed per edge 0.02 mm) and depth of cutting remained 0.15 mm, are presented as time plots (Fig. 7). Reduction of the RMS value from 0.0354 mm to 0.0271 mm and also significant reduction of transient vibration after exit the tool, are observed. In case of uncontrolled process, the dimensionless damping coefficient for workpiece mounted in a holder of the milling machine was  $\zeta \cong 0.0016$ , while in case of controlled process –  $\zeta \cong 0.0300$ . Efficiency of surveillance during performance of high speed machining is confirmed in real milling process of the flexible plate.

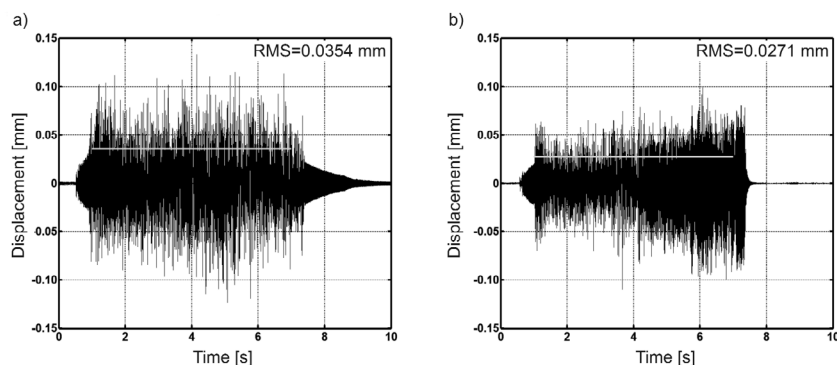

Figure 7. Time plots of the workpiece displacement, without and with surveillance, the RMS values are depicted

## 7. CONCLUSION

The novel method of the high speed milling vibration surveillance, using active vibration control of the flexible workpiece, is simulated and performed with success. The hybrid model, which included the modal model of the workpiece whose parameters are identified on a basis of appropriate modal tests, is applied for computer simulation of the milling process and vibration surveillance. Thanks to the approach of energy performance index, the optimal control command in hybrid coordinates is determined for non-stationary model of the cutting process. Active optimal control of the flexible workpiece vibration stabilises the milling process performance within a wide range of spindle speeds and allows the metal processing at more significant cutting depths.

Results of these computer simulations confirmed efficiency of the control method. The efficiency of surveillance during realization of high speed milling is confirmed in case of real machining process of the flexible workpiece vibration surveillance with the use of the active optimal control. Reduction of the vibration level, as well during the milling process, as – by its end, is noticeable. Time of the transient vibration process is significantly shortened as well.

## ACKNOWLEDGEMENTS

The research was supported by The Polish Ministry of Science and High Education, Grant No. NN 503 147134. Performance of milling experiments on the Quaser MV204IU/15 milling machine was possible thanks to The Private Enterprise Hydromechanika W. Szajda in Ostaszewo, Poland, which is kindly acknowledged.

## REFERENCES

- [1] Fiedler, U. and Sahm, A., On the cutting edge of high speed machining, in: *Fourth International Conference on Metal Cutting and High Speed Machining*, Darmstadt, Germany, 2003.
- [2] Sutter, G., Chevrier, P., Faure, L. and Petit, B., Damages analysis of cutting tools in machining of titanium alloy (Ti6Al4V), *International Journal of Mechanical Production Systems Engineering*, 2003 Avril, pp. 61-65.

## Vibration Surveillance During Milling Flexible Details with the Use of Active Optimal Control

- [3] Özel, T. and Altan, T., Process simulation using finite element method – prediction of cutting forces, tool stresses and temperatures in highspeed flat end milling, *Int. J. Mach. Tools Manufact.*, 2000, 40, pp. 713-738.
- [4] Nouari, M., List, G. and Girot, F., Wear mechanisms in dry machining of aluminium alloys. *International Journal of Mechanical Production Systems Engineering*, 2003 Avril, 22-29.
- [5] Olgac, N. and Hosek, M., A new perspective and analysis for regenerative machine tool chatter. *Int. J. Mach. Tools Manufact.*, 1998, 38, pp. 783-798.
- [6] Kwon, W.-T. and Ehmann, K.F., Tool wear monitoring by using the imaginary part of the transfer function of the cutting dynamics, *Int. J. Mach. Tools Manufact.*, 1994, Vol. 34, No. 3, pp. 393-406.
- [7] Mané, I., Gagnol, V., Bouzgarrou, B. C. and Ray P., Stability-based spindle speed control during flexible workpiece high-speed milling, *Int. J. Mach. Tools Manufact.*, 2007, Vol. 48, No. 2, pp. 184-194.
- [8] Badiaga, I., Munoa, J., Hernández, J. and López de Localle, L. N., An automatic spindle speed selection strategy to obtain stability in high-speed milling. *Int. J. Mach. Tools Manufact.*, 2009, Vol. 49, No. 5, pp. 384-394.
- [9] Kaliński, K.J. and Galewski, M., Simulation and Experiments of High Speed Machining Vibration Monitoring with Variable Spindle Velocity, *Solid State Phenomena*, 2010, 164, pp. 285-290.
- [10] Kaliński, K.J. and Galewski, M., Chatter Vibration Surveillance by the Optimal-linear Spindle Speed Control, *Mechanical Systems and Signal Processing*, 2011, Vol. 25, No. 1, pp. 383-399.
- [11] Kaliński, K.J., Galewski, M. and Sawiak, S., Reduction of vibration level by the spindle speed optimisation during ball end milling of flexible details, in: *Fifth International Conference on High Speed Machining*, Ecole Nat. Supérieure d'Arts et Métiers, Metz, France, 2006, 479-488.
- [12] Kaliński, K.J., Mazur, M. and Galewski M., The optimal spindle speed map for reduction of chatter vibration during milling of bow thruster blade, *Solid State Phenomena*, 2013, 198, 686-691.
- [13] Kaliński, K.J. and Chodnicki, M., Vibration surveillance during milling of flexible details with a use of the optimal control, in: Uhl, T. ed., *Wybrane zagadnienia analizy modalnej konstrukcji mechanicznych*, Chair of Robotics and Mechatronics AGH Kraków, Poland, 2010, 157-165.
- [14] Kaliński, K.J., The finite element method application to linear closed loop steady system vibration analysis, *International Journal of Mechanical Sciences*, 1997, Vol. 39, No. 3, pp. 315-330.
- [15] Jayaram, S., Kapoor, S. G. and DeVor, R. E., Estimation of the specific cutting pressures for mechanistic cutting force models, *Int. J. Mach. Tools Manufact.*, 2000, Vol. 41, No. 2, pp. 265-281
- [16] Kaliński, K.J., A surveillance of dynamic processes in mechanical systems (in Polish), The Publication of Gdansk University of Technology, Gdansk, 2012.

- [17] Kaliński, K.J. and Chodnicki, M., Vibration surveillance during ball end milling of curved flexible details on a basis of assessment of assurance of the model of real object, *Developments in mechanical engineering*, 2009, 3, 117-124.
- [18] Maia, N.M.M. and Silva, J.M.M., Theoretical and Experimental Modal Analysis, Research Studies Press Ltd., 1997.

