

Ewa PIĄTKOWSKA\*

## A COMPARISON OF WEAR PROPERTIES OF WATER LUBRICATED NBR AND PTFE SLIDING BEARINGS

### PORÓWNANIE ZUŻYCIA SMAROWANYCH WODĄ ŁOŻYSK ŚLIZGOWYCH Z PANWIAMI Z NBR ORAZ PTFE

**Key words:**

wear, journal shaft, bearing, rubber (NBR), polytetrafluoroethylene (PTFE), water lubrication.

**Abstract**

The excessive wear of a journal shaft can be caused by many factors, for example, working conditions (e.g., temperature, slip speed, the type of lubricant), pressure, the type of material used on the bearings and shafts and their roughness, as well as contamination remaining in the system. This paper presents the roughness profiles co-operating with a rubber (NBR) and polytetrafluoroethylene (PTFE) bushes. The conditions of cooperation between the two materials tested in the sliding combination with the stainless steel journal were the same in each pair of bearings (PV); therefore, the comparison of their wear depends only on the material properties of the bush and the deformation of the journal shaft caused by the bending moment. To assess the size of the journal shaft, they were tested using a profilograph. In addition to the journal shaft, bearings were also evaluated, the wear level of which was noticed without the use of specialized equipment.

**Słowa kluczowe:**

zużycie, czop wału, łożysko, guma (NBR), politetrafluoroetylen (PTFE), smarowanie wodą.

**Streszczenie**

Nadmierne zużycie czopa wału okrętowego może być spowodowane wieloma czynnikami, np. warunkami pracy (temperatura, prędkość poślizgu, naciski, rodzaj czynnika smarnego), rodzajem materiału zastosowanego na panwie łożysk i czopy wałów oraz ich chropowatością, a także zanieczyszczeniami dostającymi się do układu. W niniejszym artykule przedstawione zostały profile chropowatości czopa wału okrętowego pracującego w panwi wykonanej z gumy (NBR) oraz z politetrafluoroetylenem (PTFE). Warunki współpracy obu badanych materiałów w skojarzeniu ślizgowym z nierdzewnym czopem były jednakowe w każdej parze łożysk (PV), dlatego też porównanie stopnia ich zużycia zależy jedynie od własności materiału panwi oraz deformacji czopa wywołanej momentem zginającym. W celu oceny wielkości zużycia czopów zostały one poddane badaniu za pomocą profilografometru. Poza czopem wału ocenie poddane zostały również panwie łożysk, których stopień zużycia dostrzegalny był bez użycia specjalistycznego sprzętu.

## INTRODUCTION

In order to ensure long and trouble-free operation of the ship's propeller shaft assembly, it is necessary to carefully carry out design works and then to process and assemble all its components. A very important factor here is to ensure shaft alignment in relation to the bushes and seals. The misalignment of the shaft in the bearing of the slide bearing causes stress concentration on the parts of the bushing, which causes rapid wear and, in extreme cases, the deformation of the shaft and its faster wear, and consequently the need for costly renovation [L. 1, 2]. It also involves the replacement of the sliding

sleeve, which is why it is so important to choose the right material on the bushing of the stern bearing, which works under heavy load in the water environment. The existing materials used for slide bearings were white metal, guaiac, rubber, polymers, composites, sintered metals, ceramics, etc. [L. 3, 4]. The material chosen for this type of bearings should be durable, resistant to abrasion, resistant to compression, and should not absorb water.

Sliding bearings lubricated with water characterized by a relatively low price (simple construction, a small number of elements), the ability to damp vibrations, having good damping properties of the material (weak

\* Gdańsk University of Technology, Faculty of Ocean Engineering and Ship Technology, ul. Gabriela Narutowicza 11/12, 80-233 Gdańsk, Poland, e-mail: ewapiatk@pg.edu.pl

damping of the water film), reduced sensitivity to quick wear (caused by misalignment of the shaft in the bushing), but sensitivity to elevated temperature (swelling of the material, transferring the bushing material at the shaft journal), and low resistance to variable loads [L. 5–10]. In the literature, the causes of excessive wear of shafts and bushings working in the water environment were examined, as well as mechanisms that, under the influence of complex physicochemical processes, accompanied the transfer of material in the friction pair consisting in breaking the bonds and filling the surface layer with the material of the bushing. These processes may have been due to the type and size of friction, the concentration of stress, excessive temperature rise, or contaminations remaining in the system [L. 11].

Cooperating with the shipyards repair guide, it has been observed that, under identical surface pressures and sliding speeds [L. 12], bearing arrangements sometimes lead to intensive wear of the shaft in a working ship's stern bearings, and sometimes this wear was low [L. 13–15]. The problems of premature excessive wear on the journal shaft working in sliding sleeve in similar conditions have not been explained. The sliding association must be characterized by reliability, which is largely ensured by the choice of materials on the bushing and journal shaft; therefore, in this article, it was decided to compare the wear of shafts and bearings lubricated with water made of rubber (NBR) and polytetrafluoroethylene (PTFE) [L. 16, 17].

## EXPERIMENT METHODOLOGY – TEST STAND AND MEASUREMENT PROCEDURE

The tests were carried out on the test stand in conditions similar to those prevailing in a heavily loaded bearing aft propeller shaft lines. The stand has been designed so that it is possible, in a controlled manner, to apply a bending load to the shaft journal in the bearing under test [L. 18].

The diagram above presents the construction of the test stand (Fig. 1) and the tasks it performs. The electric motor drives the shaft (1), which is made of a typical in shipbuilding seawater-resistant steel. It is supported on two bearings (2,3) in front of the tank on the swinging bearing (3) in the support A and inside the tank on the tested slide bearing in the self-adjusting support (2), which caused free positioning of the shaft in the support B (in Positions I or II) during its bending. The tank (5) is filled with water, which is the lubricating and cooling medium of the tested bearing. In order to ensure a constant temperature ( $\sim 30^{\circ}\text{C}$ ) and water purity, an additional tank is installed, where the water circulates in a closed circuit. At the end of the shaft (in Position F1 or F2), there is placed a sliding bearing (4), through which the load is exerted. In front of the tank there was installed a rolling bearing, whose task is to ensure the

alignment of the shaft with the seal (7), which prevents water from escaping from the tank. Below are photos of the test stand (Fig. 2 and Fig. 3).

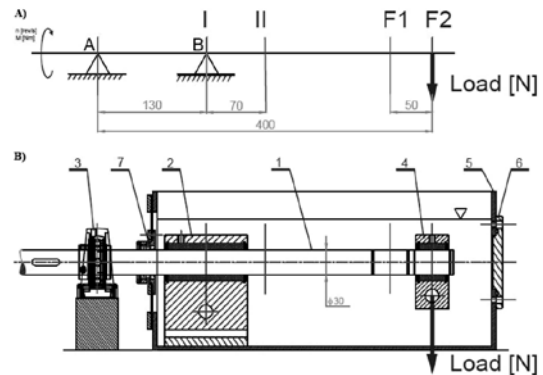

Fig. 1. Test stand A) test stand diagram, B) test stand cross-section: 1 – shaft, 2 – tested bearing in self-adjusting support, 3 – rolling bearing, 4 – sliding bearing through which load is exerted, 5 – tank filled with water, 6 – cover, 7 – seal

Rys. 1. Stanowisko pomiarowe A) schemat stanowiska, B) przekrój przez stanowisko: 1 – wał, 2 – badane łożysko w podporze samonastawnej, 3 – łożysko toczne, 4 – łożysko ślizgowe, za pośrednictwem którego wywierane jest obciążenie, 5 – zbiornik wypełniony wodą, 6 – pokrywa, 7 – uszczelnienie



Fig. 2. Test stand

Rys. 2. Stanowisko pomiarowe

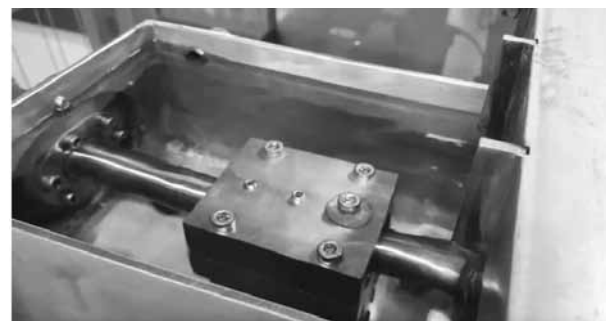

Fig. 3. A self-adjusting support in water tank

Rys. 3. Podpora samonastawna w zbiorniku z wodą

In order to compare the wear rate of plain bearings with NBR and PTFE bushings, the tests were carried out on the described test stand under the same working conditions for bearings made of these both materials. The main assumptions were as follows: approximate surface pressures ( $\sim 0.65$  MPa) in both pairs of bearings (tested and exerting a load), the same number of engine starts, and the same working time. The examination of each pair of bearings lasted for 70 hours. The engine speed was 600 rpm for the first 14 hours, and then it was increased to 1000 rpm.

The first four measurements (A-F) were made on solid shafts, while the other two were on hollow shafts. The use of hollow shafts in measurements E and F and a change in the length of the bushing in location B (Positions I or II), while maintaining the fixed length of bushing F (F1 or F2), allows one to achieve different values of bending stresses while maintaining the same surface pressures. The variable parameter here is also the bending moment. The lengths of the bushings and their position are illustrated in the **Table 1** and on the test stand diagram is shown in **Fig. 1**. The material of the shaft is typical high alloy steel (chromium-nickel 1H18N9) used for ship's shafts, with acceptable bending stresses (depending on the yield strength  $R_e$ ) in the range of 120–170 MPa. At the end of the shaft, on a bushing fixed length equal to 28 mm, at Positions F1 or F2, a 56 kg weight frame was suspended, which is supposed to imitate the load of the ship's propeller.

After 70 hours of working, the bearings were dismantled and the shaft cut into samples to evaluate the wear process of both: the shaft and the bearings. The roughness profiles of each journal were recorded using profilographometer. For each pair of bearings, these measurements were also carried out before the test. However, in this paper, only the journal shafts cooperating with the tested bearings after 70 hours of working (samples A–F) were compared.

## RESULTS

After disassembling the test stand and all journals, it was possible to perform a preliminary visual analysis of the condition of the cooperating surfaces. Already at this stage, differences in the method and quality of wear of the tested journals are visible (**Tab. 2**). In both cases, visible scratches on the entire circumference of the journal on the materials, but their surface conditions were different, which is related to the type of material used for the bearing bushings.

For more accurate identification of journal shafts wear, a profilograph was used. The tests were carried out with journals located in the self-adjusting support (Samples A–F). Roughness profiles are presented in **Table 3**. In the case of rubber (NBR), we are dealing with an uneven wear of the journal shaft along its entire length. It can also be considered that the highest wear occurred from the load application side, due to the deflection of the shaft in the self-adjusting support. In the case of the journals cooperating with PTFE bushings, the situation it is different, because the greatest changes roughness were exhibited at the extremities of the journals, and a middle portion was the least worn. This is most evident on Sample D. This sample requires a more accurate analysis, because it shows the largest traces of wear on its surface. Surface pressures are similar in all cases; however, in the case of this example, we have to deal with the greatest bending moments and reactions in the support.

There are also interesting differences in the degree of wear of the hollow shafts (samples E and F), which show higher wear in the case of cooperation with PTFE (**Table 2** and **Table 3**). One could consider here the influence of bending stresses on the degree of wear of the shaft, as in the case of NBR, no such relationship was found between them.

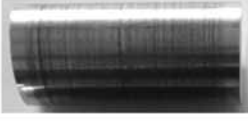

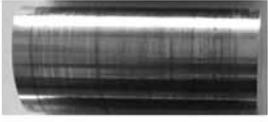
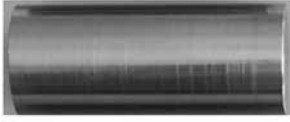
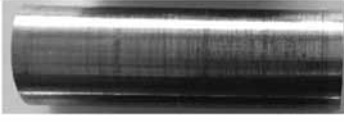

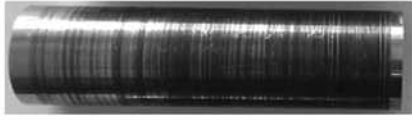

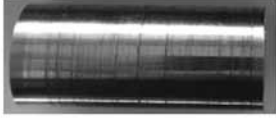



**Table 1. Measurement table**

Tabela 1. Tabela pomiarowa

indication	DATA					Reaction		Bending		Pressure	
	d – hollow diameter on the length of 380 mm	bush length B	position of support B	bush length F	application of force F	A	B	bending moment	bending stresses	in tested bearing (B)	in bearing through which load is exerted (F)
–	mm	mm	mm	mm	–	N	N	Nm	MPa	MPa	MPa
A	0	50	II	28	F1	412,02	961,38	82,40	32,55	0,641	0,654
B	0	57	II	28	F2	549,36	1098,72	109,87	43,41	0,643	0,654
C	0	77	I	28	F1	929,69	1479,05	120,86	47,75	0,640	0,654
D	0	87	I	28	F2	1140,98	1690,34	148,33	58,60	0,648	0,654
E	24	57	II	28	F2	549,36	1098,72	109,87	73,52	0,643	0,654
F	24	77	I	28	F1	929,69	1479,05	120,86	80,87	0,640	0,654

**Table 2. Statement of images of shaft journals cooperating with bushings made of NBR and PTFE in A–F positions**

Tabela 2. Zestawienie zdjęć czopów wałów współpracujących z panwiami NBR oraz PTFE w położeniach A–F

	NBR	PTFE
A		
B		
C		
D		
E		
F		

In addition to the study of the surface wear of the journal shafts, it was decided to look at the bushings. They were not tested on the profilograph, but signs of wear are visible to the unaided eye. The rubber bushing (**Fig. 4**) shows circumferential grooves, which could have arisen as a result of many interacting factors.

The susceptibility of the rubber to load and elevated temperature ( $\sim 30^{\circ}\text{C}$ ) could cause a deflection of the shaft in the self-adjusting support, the liquefaction

rubber material, and the partial transfer of rubber to the shaft journal, thereby causing premature wear. It is also possible that particulate contaminants or torn off rubber scrapings got between the journal and the bearing, which could cause them to "stick" into the softened material of the bushing and draw the circumferential grooves both on the shaft and the bearings. In contrast, the three-layer bearing bushing (**Fig. 5**) does not bear any visible signs of wear.

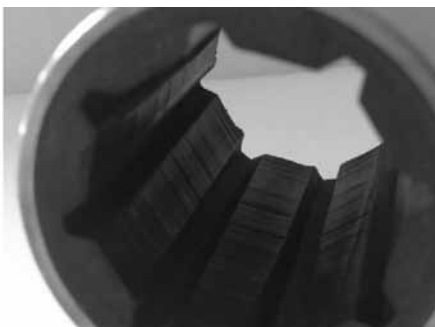

**Fig. 4. Bushing made of NBR**  
Rys. 4. Panewka wykonana z NBR

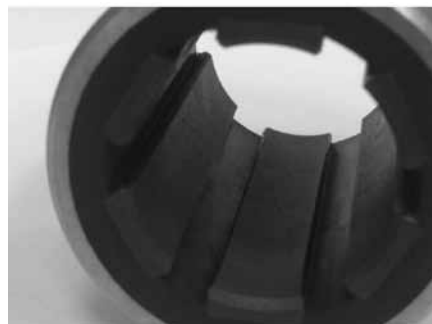

**Fig. 5. Bushing made of PTFE**  
Rys. 5. Panewka wykonana z PTFE

**Table 3. Statement of shaft roughness profiles cooperating with bushings made of NBR and PTFE**

Tabela 3. Zestawienie profili chropowatości czopów współpracujących z panwiami z NBR i PTFE

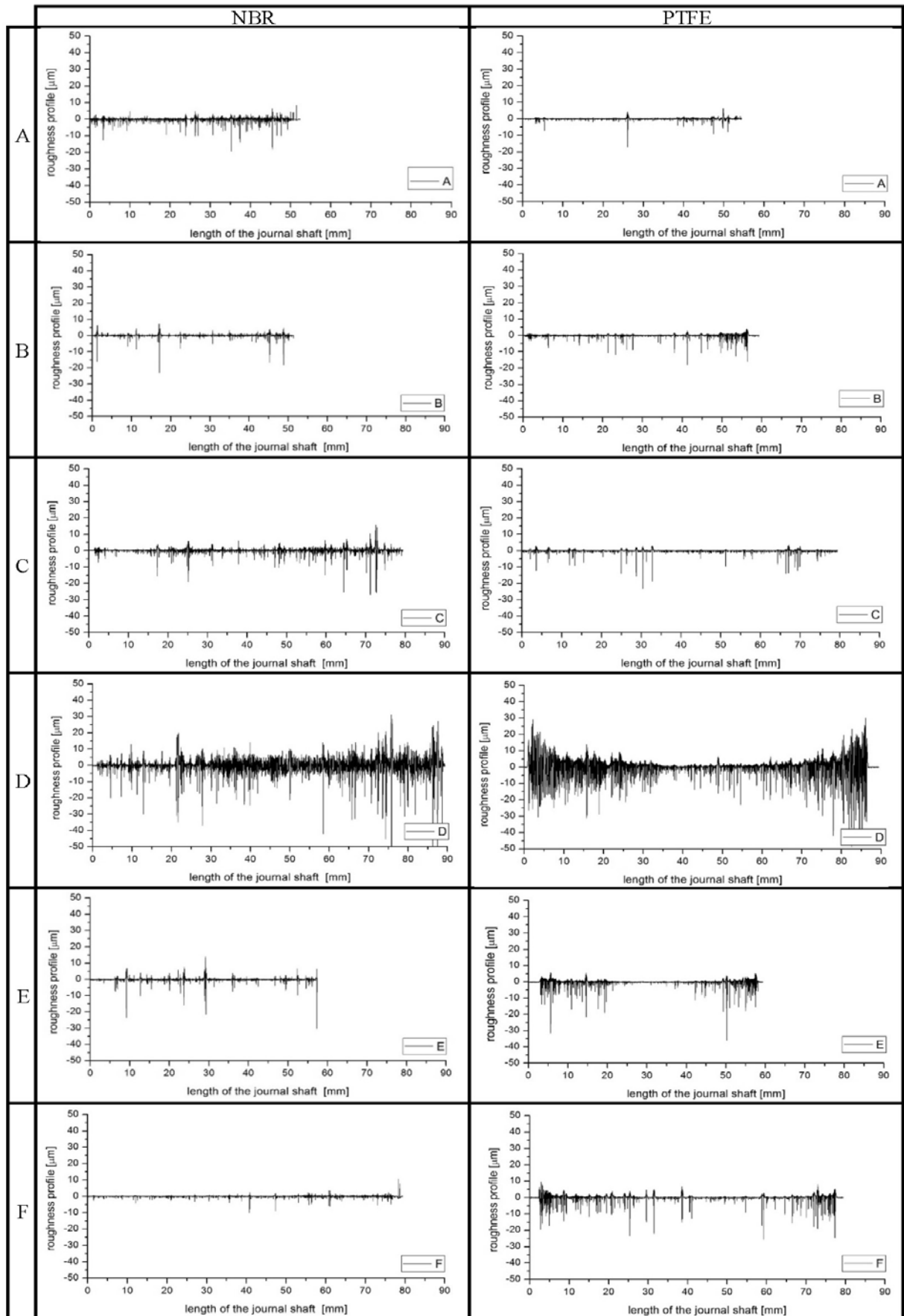



## CONCLUSIONS

Sliding nodes are one of the most vulnerable units in the operation of machinery and equipment, and their reliability and durability is required. Therefore, the most appropriate structural solutions and materials on the bearings are still being sought in order to ensure continuous and trouble-free operation of sliding associations. In this article, two materials have been evaluated: NBR and PTFE, whose properties depend to a large extent on the operating temperature.

As is apparent from the tests conducted under the same conditions, the journals and their associated rubber bushings have greater wear. Rubber (NBR) is a relatively soft material that dampens vibrations, but it is sensitive to elevated temperatures, which, in this case, caused the local transfer of the material of the bushing to the shaft and thus faster wear of rubbing pairs. It is not visible in the case of a thermoplastic polymer, such as polytetrafluoroethylene (PTFE), which is used as a construction material in a modified form. Three-layer bearings made of PTFE can carry higher pressures. For comparison, the permissible pressures for unmodified bushes are up to 1.0 MPa, while they reach up to 140 MPa for laminar. These bearings are very resistant to wear. They have a relatively low coefficient of friction and low wear, and do not absorb moisture.

The use of bearings with such small diameters ( $d = 30$  mm) is typical for small vessels that sail on relatively shallow and contaminated waters. Contaminations as solid particles can get between the bearing bush and the shaft journal and lead to

their more intense wear than expected. In this case, the need to replace the bushings can take place faster than anticipated. Therefore, the significant extension of the durability of the bushes may not be of such significance in this case considering the total costs, since the cost of the custom made PTFE bushings is 5 times higher than that of the rubber bushing.

The divergent results of the journal shaft working with the NBR and PTFE bushings may be caused by the rubber's susceptibility to deformation, bending of the shaft, and other arrangements in the self-adjusting support. An important role can also be played by the active surface of both bushes, due to the fact that the number of longitudinally distributed grooves differs for the same diameter (30 mm). In the case of NBR, there are 8 of them, while there are 6 of them in PTFE, which proves that the bearing field of both bearings operating in the same conditions can be different. According to the Classification Societies, the ratio of the length of the bearing to its inner diameter ( $l/d$ ) for NBR should be 4, while in the case of PTFE, this ratio should not be less than 2; therefore, the real load (the load capacity of the bush) may be different in both cases.

In order to obtain the most favourable working conditions, an important element is the appropriate selection of construction materials for a given sliding associations. As indicated by the analysis, it is worth investing in better quality materials and with greater reliability and durability in order to avoid premature repairs, but the cost-effectiveness of their use should be taken into account.

## REFERENCES

1. Sun J., Changlin G.: Hydrodynamic lubrication analysis of journal bearing considering misalignment caused by shaft deformation, *Tribology International*, Vol. 37, 2004, 841–848.
2. Vulić N., Šestan A., Cvitnić V.: Modelling of propulsion shaft line and basic procedure of shafting Alignment calculation, *Brodogradnja*, Vol. 59, 2008, 223–227.
3. Orndorff R.L.: Water lubricated rubber bearings, history and new developments, *Naval Engineers Journal*, Vol. 97, No. 7, 1985, 39–52.
4. Orndorff R.L., Foster L., Sheppert R.: From lab to field: New high performance water lubricated bearings, *World Tribology Congress III*, Vol. 2, 2005, 55–56.
5. Litwin W.: Influence of local bush wear on water lubricated sliding bearing load carrying capacity, *Tribology International*, Vol. 61, 2010, 130–141.
6. Litwin W.: Influence of main design parameters of ship propeller shaft water-lubricated bearings on their properties, *Polish Maritime Research* 4(67), Vol. 17, 2010, 39–45.
7. Litwin W.: Influence of local bush wear on properties of water lubricated marine stern tube bearings, *Polish Maritime Research* 1(68), Vol. 18, 2011, 32–36.
8. Hua Xijin, Wang Jiayu, Zhu Juanjan, Liu Wen Ji: Study on tribological behavior of water-lubricated bearings, *Journal of Advanced Manufacturing Systems*, Vol. 7, No. 1, 2008, 115–121.
9. Harish Hirani, Manish Verma, Tribological study of elastomeric bearings for marine propeller shaft system, *Tribology International*, Vol. 42, 2009, 378–390.
10. Hirani H., Verma M.: Tribological study of elastomeric bearings for marine propeller shaft system, *Tribology International*, Vol. 42, 2009, 378–390.
11. Polak A.: Przenoszenie materiału w łożysku ślizgowym stal-tworzywo sztuczne, *Politechnika Krakowska im. Tadeusza Kościuszki*, pp. 21–34, 1998, 109–135.

12. Conglin Dong, Lichun Shi, Lvzhou Li, Xiuqin Bai, Chengqing Yuan, Yu Tian: Stick-slip of water-lubricated polymer stern tube bearing materials during starting process, *Tribology International*, Manuscript Draft.
13. Kikkawa F., Uchida Y., Fujita K., Yano A., Kawazoe T., Sada H.: Study on damage of propeller shaft sleeve for seawater lubricated rubber bearing -2nd Report, Translated from *Journal of the JIME*, Vol. 43, No. 2, 2008. (Original Japanese)
14. You-Qiang Wang, Xiu-Jiang Shi, Li-Jing Zhang: Experimental and numerical study on water-lubricated rubber bearings, *Industrial Lubrication and Tribology*, Vol. 66, Iss 2, 2014, 282–288.
15. Šverko D., Šestan A.: Experimental determination of stern tube journal bearing behaviour, *Brodo Gradnja*, Vol. 61, 2010, 130–141.
16. Litwin W.: Experimental research on water lubricated three layer sliding bearing with lubrication grooves in the upper part of the bush and its comparison with a rubber bearing, *Tribology International*, Vol. 82, 2015, 153–161.
17. Kikkawa F.: Performance enhancement of seawater lubricated stern tube bearings – PTFE bearing optimal for environmental conservation and energy saving, Translated from *Journal of the JIME*, Vol. 46, No. 1, 2011. (Original Japanese)
18. Piatkowska E.: Evaluating the influence of bending stress on a 1H18N9 steel shaft wear process in a water lubricated sliding bearing with a rubber bushing, *Tribologia*, Vol. 6, 2017, 79–85.

