



Article

Designing of Parking Spaces on Parking Taking into Account the Parameters of Design Vehicles

Miroslava Mikusova ^{1,*} , Jamshid Abdunazarov ², Joanna Zukowska ³  and Juraj Jagelcak ¹

¹ Faculty of Operation and Economics of Transport and Communications, Department of Road and Urban Transport, University of Zilina, Univerzitná 8215/1, 010 26 Zilina, Slovakia; juraj.jagelcak@fpedas.uniza.sk

² Faculty of Auto Transport, Department of Land Transport Systems, Jizzakh Polytechnic Institute, Islam Karimov Avenue 4, 130100 Jizzakh, Uzbekistan; jamshid1986_86@list.ru

³ Faculty of Civil and Environmental Engineering, Gdansk University of Technology, 11/12 Gabriela Narutowicza Street, 80-233 Gdańsk, Poland; joanna.zukowska@pg.edu.pl

* Correspondence: mikusova@fpedas.uniza.sk; Tel.: +421-949-67-46-41

Received: 9 June 2020; Accepted: 29 July 2020; Published: 5 August 2020



Abstract: Nowadays, in all cities, there is an acute problem of a lack of parking spaces. The number of vehicles is constantly increasing not only in big cities and megacities, but also in small towns of the country, and there are not enough parking places—the pace of solving the problem is several times slower than the growth rate of transport among citizens. The paper is dedicated to the determination of an optimal size of a parking place for design vehicles in a parking space as an element of roads. In the example of passenger cars and trucks, the optimal number of parking places is presented. The results of the research on the dimensioning of parking spaces serve as recommendations and can be used for the design of objects of transportation infrastructure. According to the research, authors introduce the term “design vehicle” and provide its definition. They also figure out optimal parameters for each design vehicle and recommend a special template for designing parking places.

Keywords: passenger car; truck; auto train; trajectory; parking space; software AutoTURN; vehicle turning

1. Introduction

Discussions regarding the parking problematics have a long history. The first descriptions of parking principles were provided in [1–3]. They were followed by empirical studies related to the factors that determine the choice of a parking space [4], regulations of on-street parking [5], the impact of parking fees on travel costs [6–9], and the influence of parking policies on the distribution of congestion in urban areas [10]. There were also developed some interesting studies on drivers’ behaviour in the process of on-street parking, and the impact of parking on the traffic flow, its speed and travel time [11,12] together with the stochasticity determination in the process of drivers’ search for a vacant parking space [13]. The source [14] provides a detailed analysis of different parking demand models. A detailed definition of the parking characteristics based on parking demands is described in [15]. The current research focuses on looking for solutions for parking in residential areas [16], popular destinations [17], and the future of the parking in relation to the introduction of automated vehicles in our streets [18].

Recent developments head towards the transformation of our cities into Smart Cities. One of the directions of a Smart City is a Smart Parking System. Also, one part of the Smart Parking System is the design of a parking area and a justification of a correct dimension of a car park, as parking problems belong to the most emerging problematics in today’s cities. This issue in relation to the Smart Cities is mentioned in different topical researches, for example, [19–21]. Typically, the rationale

behind sustainable versatility is the crucial point of essential diminishing of contamination in cities [22], reducing the costs of service at the same time.

The main purpose of this paper is to determine the optimal size of a parking place for design vehicles, to set optimal parameters for different types of design vehicles, and to recommend a special template for designing various elements of roads.

The paper is divided into five sections. The first section provides a description of the research problem and it presents the methodology applied for conducting the study. It focuses on deficiencies in the process of designing the parking space that are caused by the lack of consideration of the size of vehicles in the traffic flow and its composition. The issue is described using examples from Moscow where the acute problem of parking was manifested during the imposition of a ban for transit movement in the daytime, and also from Europe where this issue was culminated by the cause of the obligation to take mandatory safety breaks and daily/weekly rest times for truck drivers. In this part, the authors also present the current state of the art of the research related to the optimal dimensioning of the parking space. The second section is theoretical and it presents a series of equations that—on the basis of distances between the main sensor (GPS-702GG) located on the truck and two G3Ant-3AT1 sensors located on the trailer (r_1 and r_2 distances)—made it possible to determine dynamic dimensions of a road train. The third section of the paper presents materials and methods used to determine parameters of the parking space located at different angles (90° , 60° and 45°) based on four scenarios of the vehicle movement (way forward, backing, forward ride, reversing). It also contains manoeuvring schemes and graphics regarding the dependence of the area of the parking space on the number of parking places. The fourth section contains research results, including the recommended size of design vehicles, their minimum radius, schemes and dimensions of parking spaces for different types of design vehicles, the template for the design of single parking elements, and dimensions and average areas of one parking space. The last section provides brief conclusions from the presented research.

2. Description of the Research Problem

Up until 2000, it was popular to own “big” cars, whereas now, people in megalopolises have started to prefer small cars, the advantages of which are as follows: lower consumption of expensive gasoline, and affordability in purchasing. On highways, on the contrary, truck trains with heavy payloads began to actively occupy the place of trucks.

Every year, technical and economic indicators and dynamic parameters of automobiles improve, and accordingly, requirements for improving the standards of designing roads increase. Cars of different dimensions determine the choice of geometric elements of roads. At the initial stage of designing the geometric elements of highways, the choice of the so-called “design vehicles” is necessary.

Improving the dynamic characteristics of vehicles requires the improvement of construction technology and designing roads. When designing roads there is a need to improve the concept of “design vehicles”. For example, in the design of a pavement, a design vehicle is used as a load standard. With regard to the design of geometric intersection elements, the calculated ones are cars or trucks of certain body sizes, the radius of rotation of the steered wheels, and some other specific parameters that characterize the trajectory of the vehicle movement.

Trends in the size of cars in the traffic flow, and an acute shortage of the parking space require a more careful attitude to the design of the size of parking places and parking space. Unfortunately, the design of parking does not take into account the composition of the traffic flow that takes shape on a specific road, transport infrastructure objects (requirements are obvious in the USA where the size of cars is bigger than in Europe, and the size of parking space is larger, too), the duration of parking is not considered either (short-term parking near shops, banks, etc., requires more space for manoeuvring upon arrival and departure from the parking space than during long-term parking), etc.

In Europe, the issue of missing parking spaces culminated after the introduction of smart tachographs linked with GNSS that have become mandatory for all newly registered freight vehicles in EU Member States since June 2019. This change allowed for the realization of a remote control

of compliance with the social rules on driving times and rest periods through vehicle monitoring. Planning transportation schedules started to be affected by requirements put on rest areas and their facilities on each route.

In Russia, the most acute problem manifested itself when a ban was imposed on the transit movement of vehicles weighing more than 12 tons in the daytime along the Moscow Ring Road (Resolution of the Mayor of Moscow dated 15 November 2012, No. 650-PP “On Amendments to Legal Acts of the Government of Moscow” [23]). According to the Moscow mayor’s office, more than 150 thousand trucks with a maximum weight of more than 3.5 ton are moving through the city streets in the daytime. About 40 thousand trucks arrive from the regions daily.

At the Moscow Ring Road, about 30% of the flow is composed of large trucks, half of which are transit ones and do not serve for the needs of the capital [24]. At this time, there was no experience in designing parking places for the cars arriving in Moscow or following in transit.

In Uzbekistan and Russian national regulatory and procedural documents, the dimensions of parking spaces for road infrastructure facilities are defined in the Methodological Recommendations [25]. The dimensions set in these documents were borrowed from the Handbook for Automobile Transportation and Traffic Management [26] published in the Soviet Union in 1981, which, in turn, was a translation of the American Road Traffic Management Handbook from the year 1965, and the recommendations given in the third edition of the Transportation and Traffic Engineering Handbook [27].

Requirements for parking geometry in regulatory documents contain ambiguous, sometimes even contradictory information that may adversely affect the level of road safety. Thus, in the “Methodological recommendations on the design and equipment of highways to ensure traffic safety” [28], the turning radius of passenger cars is 8 m, and for trucks it is 9–12 m. For the approximate calculation of the total area of coverage in a parking place, including the area of manoeuvring and parking, it is recommended to proceed from the average area per one passenger car of 25 m², and per truck of 40 m². At the same time, in the album of typical projects “Cross-sectional profiles of highways passing through settlements” (TP503-0-47.86), the average parking area for a truck should be 92.4 m², not 40 m², as stated in the methodological recommendations. The dimensions of the parking space given in the Regulations for the placement of multifunctional zones of road service on roads [29,30] take into account the size of modern cars, but this is not enough in order to develop a complete planning solution since the parking manoeuvres are not taken into account, and only the dimensions of the parking space are provided. As we know that, while determining the size of car parks, you must first determine “design vehicles”.

After gaining independence, the update process of regulatory documents began. When designing roads, the ShNK 2.05.02-07 “Highways” was introduced in 2008 in replacement of KMK 2.05.02-95 “Highways”. The ShNK sets design standards for newly built, reconstructed, and overhauled public roads and departmental roads. However, this regulatory document does not discuss the use of settled vehicles in the design of geometric elements of roads. Only the maximum dimensions of vehicles are given in the ShNK, in which public roads are designed to pass vehicles with dimensions of the length of single cars up to 12 m, automobile and tractor trains up to 24 m, and the width up to 2.5 m and the height up to 4 m.

In the regulatory documents of the Republic of Uzbekistan, in particular in the MSHN 25-05 “Guidelines for ensuring traffic safety on highways”, the term “design vehicle” is not explained. However, in this regulatory document, settled vehicles are divided into two types, namely a passenger car and a truck.

The passenger car and truck parking schemes used in the United States, and the dimensions of parking spaces shown in Figure 1 provide more complete information.

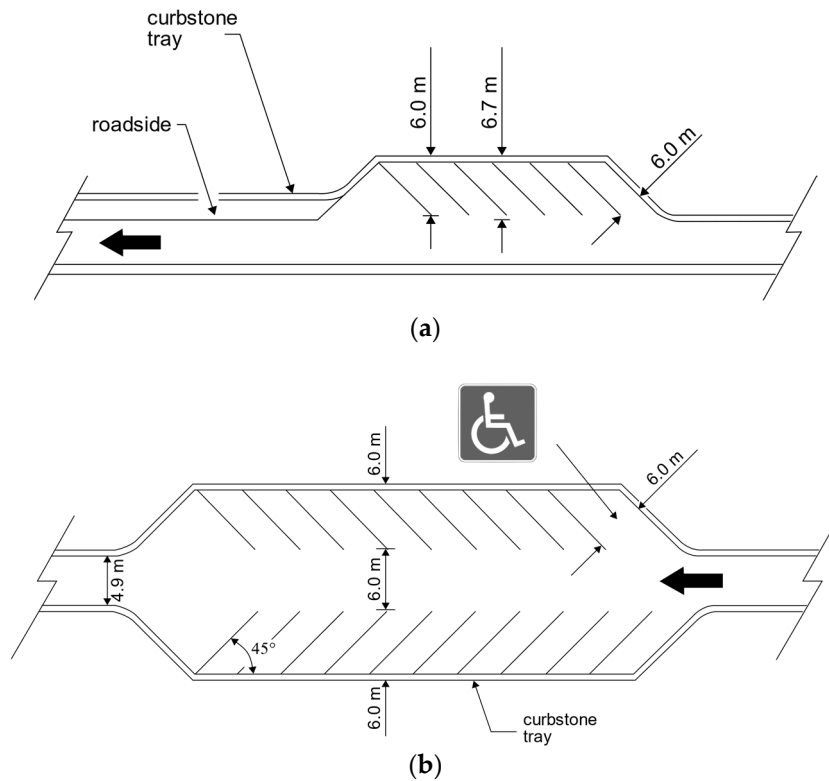

Figure 1. Schemes of planning of parking spaces for passenger cars with one-sided (a) and two-sided (b) placement in the USA.

The planning solution for placing parking spaces for trucks, which provides the simplest conditions for entering and leaving a parking space recommended in the USA, is shown in Figure 2. The sizes presented in the scheme in Figure 3 correspond to a parking angle of 45°, while it is indicated that at an angle of 30° the width of the passages can be reduced to 6.0 m, and the width of each parking space by 30 cm. For large trucks, the length of the longitudinal parking space must be at least 41 m with a width of 5.2 m. The same values are specified in the regulations of the United Arab Emirates for large trucks in parking spaces.

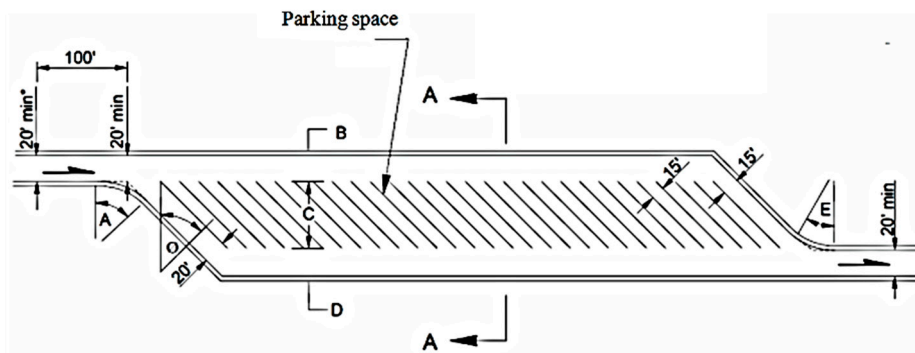

Figure 2. The fundamental planning of the placement of parking spaces for trucks recommended in the USA: Φ -30–45°; A-25.9–30.5 m; B-9.1–13.7 m; C-15.2–18.8 m; D-9.1–13.7 m; E-30.5–35.0 m.

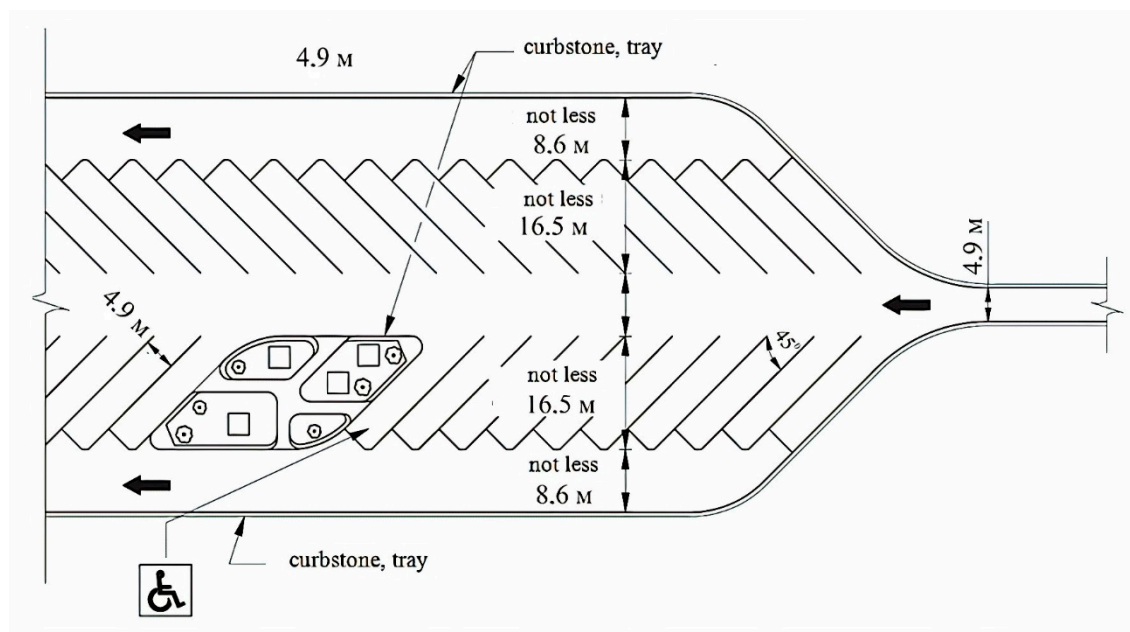

Figure 3. Scheme of parking spaces for trucks in the USA.

To find an optimal space for parking, many scientific researches have been conducted. Reza Iranpour and David Tung [31] suggested a new method to look at the optimal design, the maximization of capacity, and the best layout for parking manoeuvres of a corner lot for parking spaces. Certain assumptions and practical design principles are used to derive the model, a system of nonlinear equations. The model is applied to a rectangular corner lot and solved by the iteration using real generated data for combinations of compact and standard cars. William Young [32] studied parking lot design models using a computer aid design. This research concentrates on the development of models that aid the designer in measuring the efficiency of particular parking-lot systems. The models discussed in the mentioned source aim to present the designer with information on the demand for the parking space and the performance of the system. The research by Thananchai Leephakpreeda [33] presents the modelling of vehicles in the parking place. The source [34] describes software for the Smart Parking System that was developed using the Object-Oriented Analysis and Design (OOAD) method. Department of Survey and Design of Roads (MADI) conducted research to justify the size of parking spaces for vehicles, taking into account the characteristics of modern traffic on roads. The research work included the following steps: monitoring parking manoeuvres; studying the real situation when setting up parking spaces; modelling parking manoeuvres of passenger cars and trucks using the AutoTURN software, which enables to simulate the movement and manoeuvring of vehicles at speeds up to 60 km/h, and also to model three-dimensional movement on a 3D surface; localizing modelling for various groups of vehicles; graphical representation of dynamic dimensions, indicating the dynamic dimensions of the vehicles (external and internal wheels, characteristic points of the body); and creating vehicle reversal patterns [35]. Simplified structure of conducted research is described on the scheme in the Figure 4.

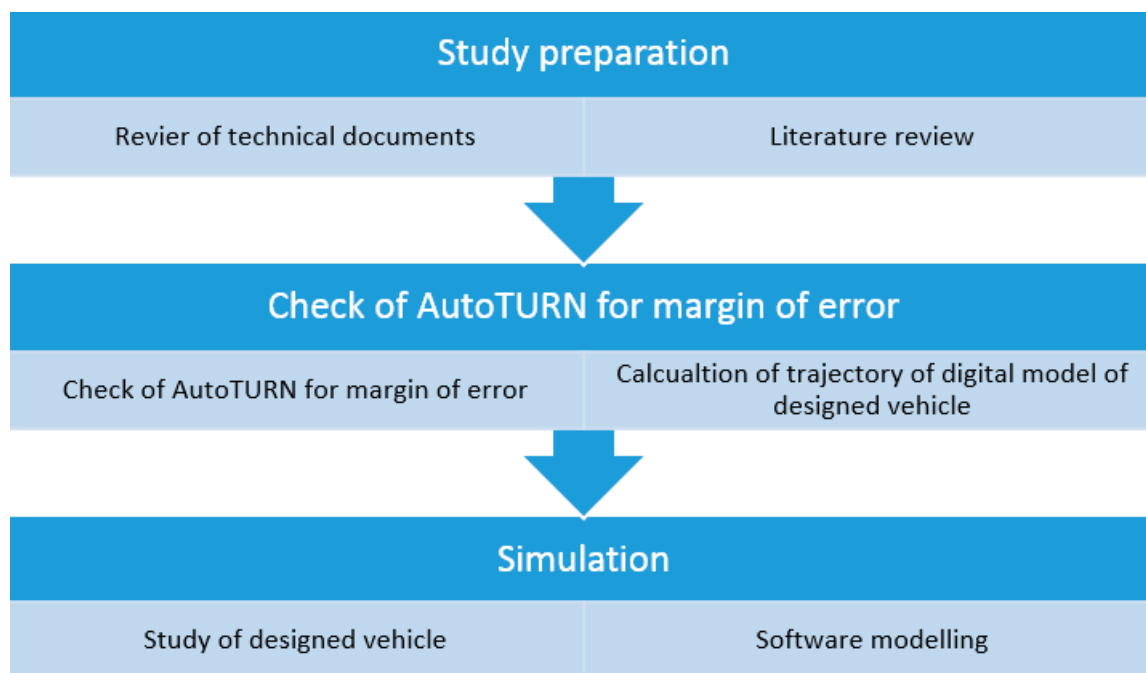

Figure 4. The structure of the conducted research.

The parking space for vehicles includes car parks for vehicles and a manoeuvring area, designed for the entrance to parking spaces, exit and setting cars. The dimensions of the parking space must ensure unhindered entry, opening the doors of the vehicles, unloading or loading luggage, and then an unimpeded exit without hitting other vehicles.

The dimensions of the parking space should be determined by the type and the size of the design vehicle (length, width, turning radius of the inner rear wheel, overhang, base and gauge). In order to be able to bypass and open the doors of the car, the parking dimensions should be 0.5 m larger than the corresponding dimensions of the design vehicles [36]. So, it means the clearance between parked vehicles is 1 m (Figure 5).

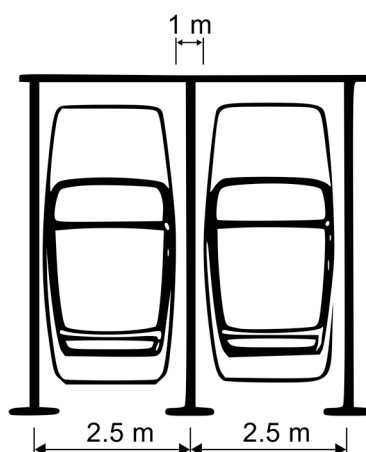

Figure 5. Clearance between parked vehicles.

The “Methodological guidelines for the design and equipment of highways to ensure traffic safety” [37] indicate that parking at large recreation areas, at roadside catering establishments, motels and campgrounds should be placed between the highway and buildings with the vehicle separation based on their types and sizes. Parking areas for trucks and passenger cars should be clearly demarcated and they should provide a separate entrance to the appropriate temporary parking area for each type

of vehicle. In this case, passenger cars and buses are recommended to have parking spaces on the left, and trucks on the right side in the direction of travel. It is recommended to place the parking of trucks parallel to the axis of their movement, while parking of passenger cars should mainly be arranged according to an oblique angle at an angle of $45\text{--}60^\circ$. For long stays in the parking place, as well as in cramped conditions, when the parking place has one exit only, it is recommended to install vehicles perpendicularly to the direction of the axis of the movement. Recommendations are given for the designation of the average area of coverage for one vehicle, taking into account the area of the exit and entry zones, and the area of the parking space itself.

Due to the increase in the dynamic characteristics of vehicles, the requirements for the construction and design of roads are being improved. It becomes necessary to introduce the concept of the “design vehicle” in road designs. This term is defined differently. “A design vehicle is a vehicle used to determine the geometrical parameters of roads (minimum turning radii of the intersection at one level, turning radii of roundabouts) affecting the safety, capacity and cost of the intersection. This is a conditional transport unit, the parameters of which are used in the calculations of the pavement and its elements [38].” “A design vehicle is such a car, the mass, dimensions and dynamic qualities of which are used when designing a road. The parameters of the design vehicle, such as dimensions and the minimum turning radius, should be the same as most other vehicles of the same class, which are supposed to be used for the movement of the designed road [39]”.

In the process of designing roads and parking spaces, it becomes necessary to determine the width of the path of the overhang, the size of the manoeuvring space, and geometric parameters. In each case this requires the construction of the dynamic dimension of design vehicles, which is a time-consuming process (especially for road trains) that is not sufficiently mastered by designers.

The lack of systematic reference materials on these issues is often the cause of unreasonable design decisions, which either lead to an overestimation of the estimated cost of facilities or do not provide normal operating conditions for vehicles.

3. Theoretical Part

For the sake of testing, the authors determined the parameters of the design vehicle based on the previous studies [40]. The main issue was how to check the AutoTURN program for a margin of error. To do this, three GPS devices were installed on the truck and field research was conducted (Figure 6).

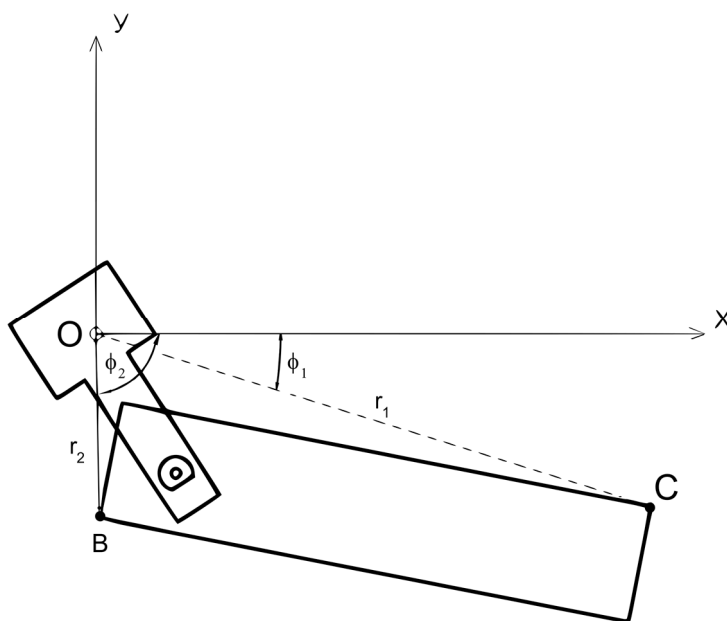

Figure 6. The layout of points O, B and C on the truck.

At point O, a GPS-702GG sensor was located, which determined the trajectory of the truck. G3Ant-3AT1 sensors were located at points B and C, which made it possible to measure the angle of the sensor in relation to the GPS-702GG sensor, i.e., at point O. Thus, the authors were aware of the location of the coordinates of point O, the angle of the body position Φ_1 and Φ_2 , while the distances OC and OB were unknown. The distance OC is denoted by the index r_1 , the distance OB is denoted by r_2 . To determine the distances r_1 and r_2 , the scheme in Figure 6 was simplified and there was created a truck rotation diagram in the rectangular coordinate system that made it possible to apply the simplified calculation scheme in order to determine values of indices r_1 and r_2 (distances between main GPS sensor located at point O and two G3Ant sensors located at points B and C; see Figure 7).

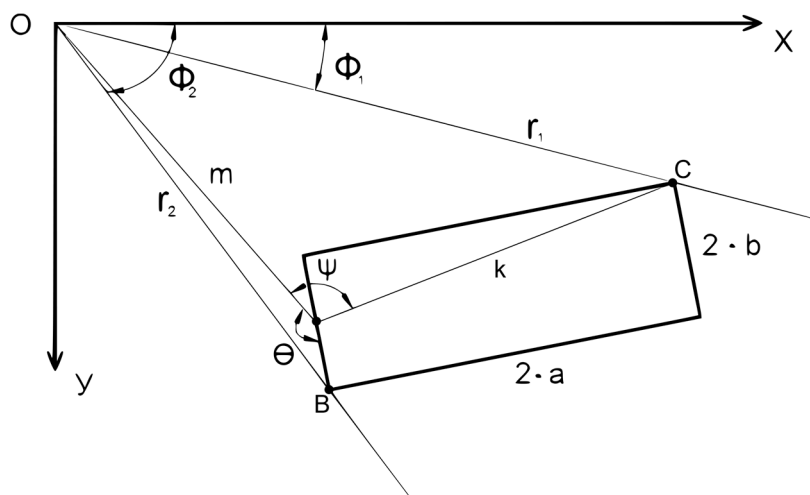

Figure 7. Truck rotation diagram in the rectangular coordinate system.

As follows from Figure 7, the angle ϕ_1 is the angle between OX and r_1 , the angle ϕ_2 is the angle between OX and r_2 , the angle Ψ is the angle between m and k , the angle θ is the angle between m and b . Then Formula (1) was created, based on the Pythagorean theorem for a right angled triangle.

$$k = \sqrt{(4 \cdot a^2 + b^2)} \tag{1}$$

To determine the values of r_1 and r_2 , the following system of equations was created:

$$\begin{cases} r_1^2 + r_2^2 - 2 \cdot r_1 \cdot r_2 \cdot \cos(\phi_2 - \phi_1) = 4 \cdot a^2 + 4 \cdot b^2 \\ m^2 + 4 \cdot a^2 + b^2 - 2 \cdot m \cdot \sqrt{(4 \cdot a^2 + b^2)} \cdot \cos \Psi = r_1^2 \\ m^2 + b^2 - 2 \cdot m \cdot b \cdot \cos \theta = r_2^2 \text{ or } m^2 + b^2 + 2 \cdot m \cdot b \cdot \cos(\Psi - \arctg(\frac{2a}{b})) = r_2^2 \\ \text{re } \Psi \in [\arctg(\frac{2a}{b}); \pi - \arctg(\frac{2a}{b})] \end{cases} \tag{2}$$

Substituting (1) and (2) the following solution was obtained:

$$\begin{aligned} & m^2 + 4 \cdot a^2 + b^2 - 2 \cdot m \cdot \sqrt{(4 \cdot a^2 + b^2)} \cdot \cos \Psi + m^2 + b^2 + 2 \cdot m \cdot b \cdot \cos(\Psi - \arctg(\frac{2a}{b})) \\ & \quad \cdot \cos(\Psi - \arctg(\frac{2a}{b})) \\ & \quad \cdot \sqrt{m^2 + 4 \cdot a^2 + b^2} - 2 \cdot \sqrt{m^2 + 4 \cdot a^2 + b^2} \cdot \sqrt{(4 \cdot a^2 + b^2)} \cdot \cos \Psi \\ & \quad \cdot \sqrt{m^2 + b^2 + 2 \cdot m \cdot b \cdot \cos(\Psi - \arctg(\frac{2a}{b}))} \cdot \cos(\phi_2 - \phi_1) \\ & = 4 \cdot a^2 + b^2 \end{aligned} \tag{3}$$

Then the right-hand side of (3) was moved to the left:

$$\begin{aligned}
 2 \cdot m^2 + 4 \cdot a^2 + 2 \cdot b^2 - 2 \cdot m \cdot \sqrt{(4 \cdot a^2 + b^2)} \cdot \cos \Psi + 2 \cdot m \cdot b \\
 \cdot \cos\left(\Psi - \arctg\left(\frac{2a}{b}\right)\right) \\
 - 2 \sqrt{m^2 + 4 \cdot a^2 + b^2 - 2 \cdot m \cdot \sqrt{(4 \cdot a^2 + b^2)} \cdot \cos \Psi} \\
 \cdot \sqrt{m^2 + b^2 + 2 \cdot m \cdot b \cdot \cos\left(\Psi - \arctg\left(\frac{2a}{b}\right)\right)} \cdot \cos(\phi_2 - \phi_1) - 4 \cdot a^2 \\
 - 4 \cdot b^2 = 0
 \end{aligned} \tag{4}$$

$$\begin{aligned}
 2 \cdot m^2 - 2 \cdot b^2 - 2 \cdot m \cdot \sqrt{(4 \cdot a^2 + b^2)} \cdot \cos \Psi + 2 \cdot m \cdot b \cdot \cos\left(\Psi - \arctg\left(\frac{2a}{b}\right)\right) \\
 - 2 \sqrt{m^2 + 4 \cdot a^2 + b^2 - 2 \cdot m \cdot \sqrt{(4 \cdot a^2 + b^2)} \cdot \cos \Psi} \\
 \cdot \sqrt{m^2 + b^2 + 2 \cdot m \cdot b \cdot \cos\left(\Psi - \arctg\left(\frac{2a}{b}\right)\right)} \cdot \cos(\phi_2 - \phi_1) = 0
 \end{aligned} \tag{5}$$

By substituting the numerical values of m , a , and b into the obtained Equation (2), the Ψ (value in radians) was obtained and r_1 and r_2 were determined. After getting the value Ψ , its value in the Equations (3) and (4) was substituted, and the values r_1 and r_2 were checked.

Thus, the sequential solution of Equations (1) and (5) with a certain integration step allows us to obtain the values of r_1 and r_2 , with which it was subsequently possible to determine the dynamic dimension of the road train.

Since the GPS-702GG was the main “master”, it determined the trajectory of the road train, i.e., it determined the coordinate location of the sensor in the time-space. By the location of the G3Ant-3AT1 sensors, the angle between them was determined, according to which the dynamic dimension of the road train was found. After receiving the data in txt and log formats, it was necessary to “materialise” the data. Since more than 22,500 values were obtained, the subsequent processing was automated as a result of the research. To do this, a “screen” scr format was used, which allowed to enter the data in AutoCAD2012 and to get the location of the sensor by coordinates.

After this, with the help of the AutoTURN program, a digital model of a design vehicle was created and the experiment with the calculation of manoeuvrability of vehicles in a limited area started. We have adopted this method since the use of the software product enables to save time, money and labour, and this software has been calibrated and showed only a 4.07% margin of error, which justified the use of this product in the conducted research.

4. Materials and Methods

To determine the width of manoeuvring on parking spaces, the minimum turning radius of the design vehicle and its dynamic clearance were taken into account. To do this, several experiments were effectuated that enabled to determine these characteristics [41]. In the study, the width of the passage was determined as follows. When designing the parking space and the vehicle entrances at parking spaces, the following scenarios were applied in the calculations:

1. The road train leaves the parking place in the forward direction;
2. The road train drives backwards in a parking place;
3. The road train drives forward in a parking place;
4. The road train leaves the parking place in reverse.

These scenarios are described in the schemes provided in Figure 8.

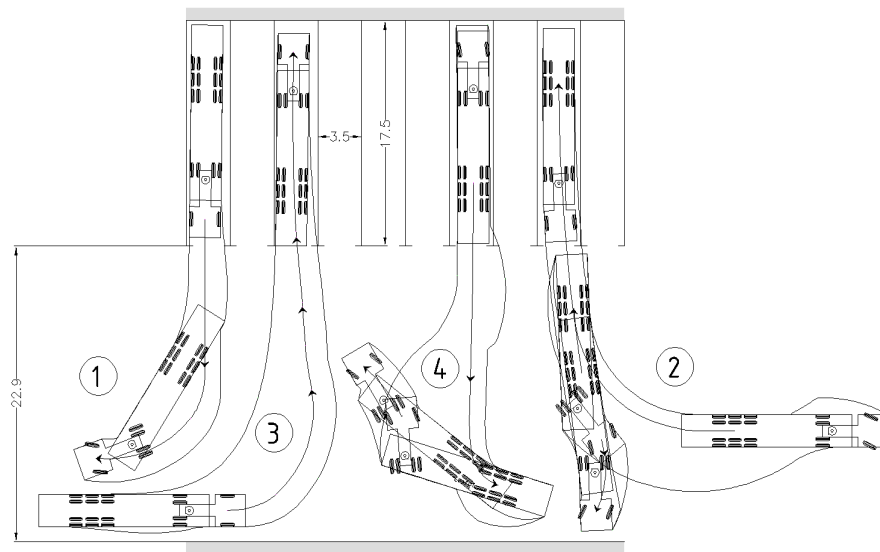

(a)

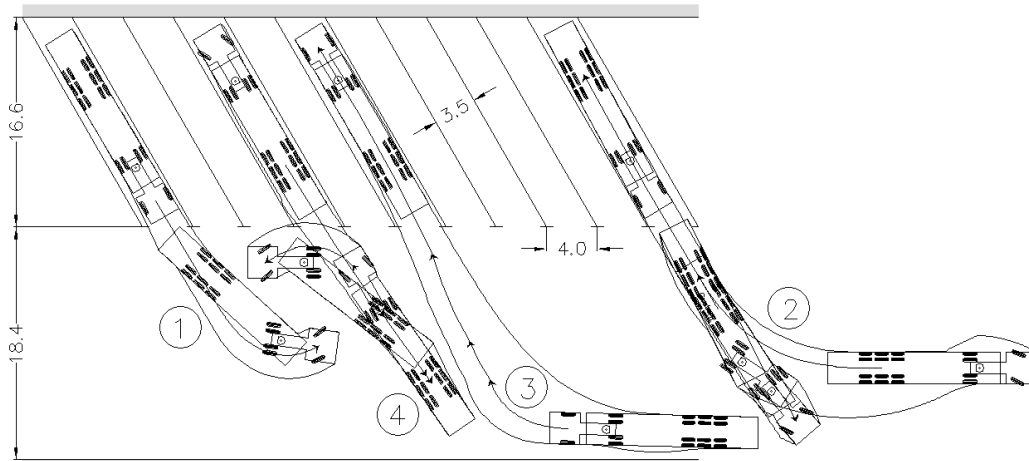

(b)

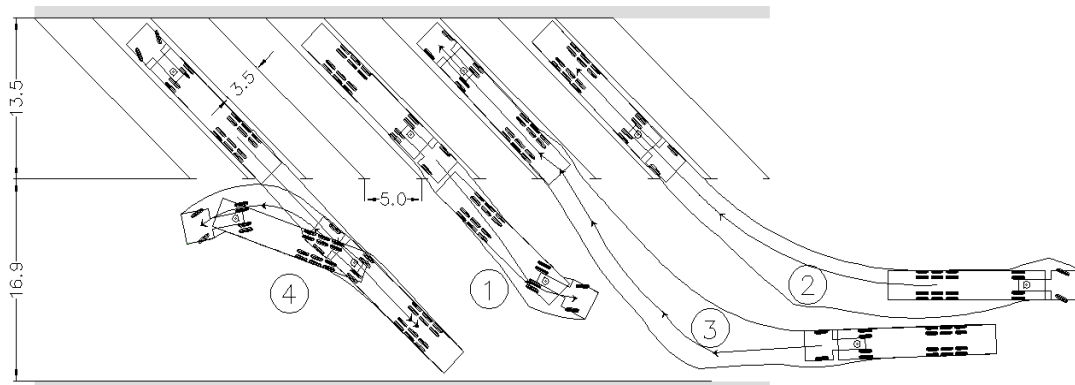

(c)

Figure 8. Manoeuvring schemes for a large goods vehicle (16.5 m) in a parking: (a) location of the parking space at an angle of 90° ; (b) location of the parking space at an angle of 60° ; (c) location of the parking space at an angle of 45° ; 1—way forward; 2—backing; 3—forward ride; 4—reversing.

It was found out that for reversing, a larger manoeuvring lane is needed when compared to other variants. This manoeuvre is a common parking method for road train drivers. With this in mind, the width of the manoeuvring strip was determined.

The design vehicle made four types of a manoeuvre at the location of the parking space at an angle of 90°, 60° and 45° (Figure 8). After each manoeuvre, the parking length, manoeuvring lane, and parking width were determined.

The results of the study showed that for one passenger car, while taking into account the manoeuvring, 28.7 m² of parking space is needed. For a road train with the length of 16.5 m, this value is 143.1 m² of area.

Figure 9 implies that, with more than five parking spaces, the area of parking space for one vehicle does not increase (depending on the angle). When the parking space is located at an angle of 90°, and if there are less than 5 parking spaces in the parking, the parking space is reduced by one car. At the location of parking spaces at angles of 60° and 45°, the indicator is 4 parking spaces. Similar values were obtained for cars and for trucks. As a result, it can be concluded that, when parking places are designed at an angle of 90°, designing less than five parking spaces is ineffective for any type of a car, and if placed at an angle of 60° or 45°, up to four parking spaces are considered ineffective.

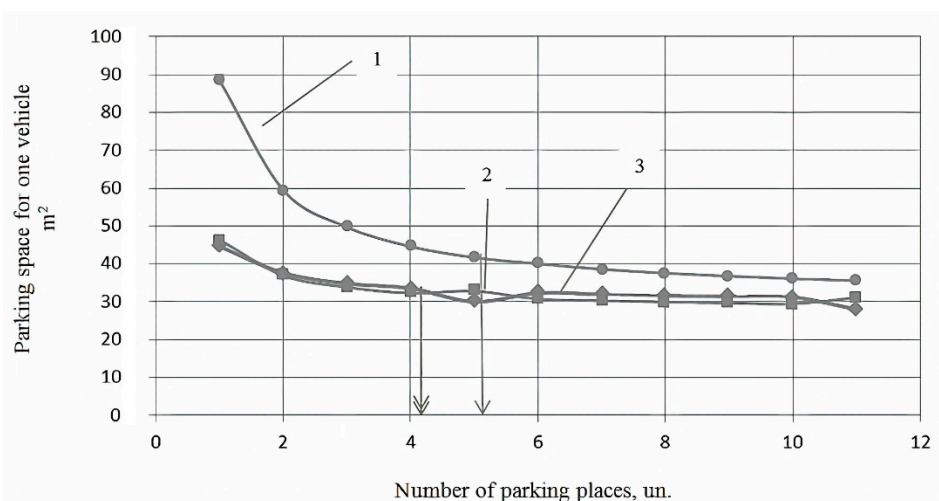

(a)

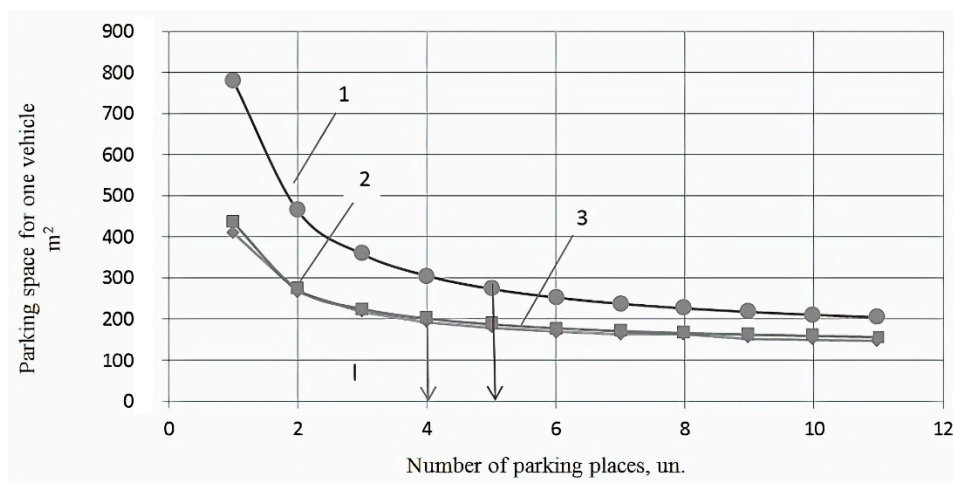

(b)

Figure 9. The dependence of the area of the parking space on the number of parking spaces for passenger cars (a) and for a 16.5 m long road train (b) when set at the corners: 1–90°; 2–60°; 3–45°.

From Figure 10 it follows that at the location of parking spaces at an angle of 45° fewer parking spaces are required than at an angle of 60° or 90°. These values do not affect the number of parking spaces. Moreover, these values are the most effective indicators when manoeuvring cars on the parking site.

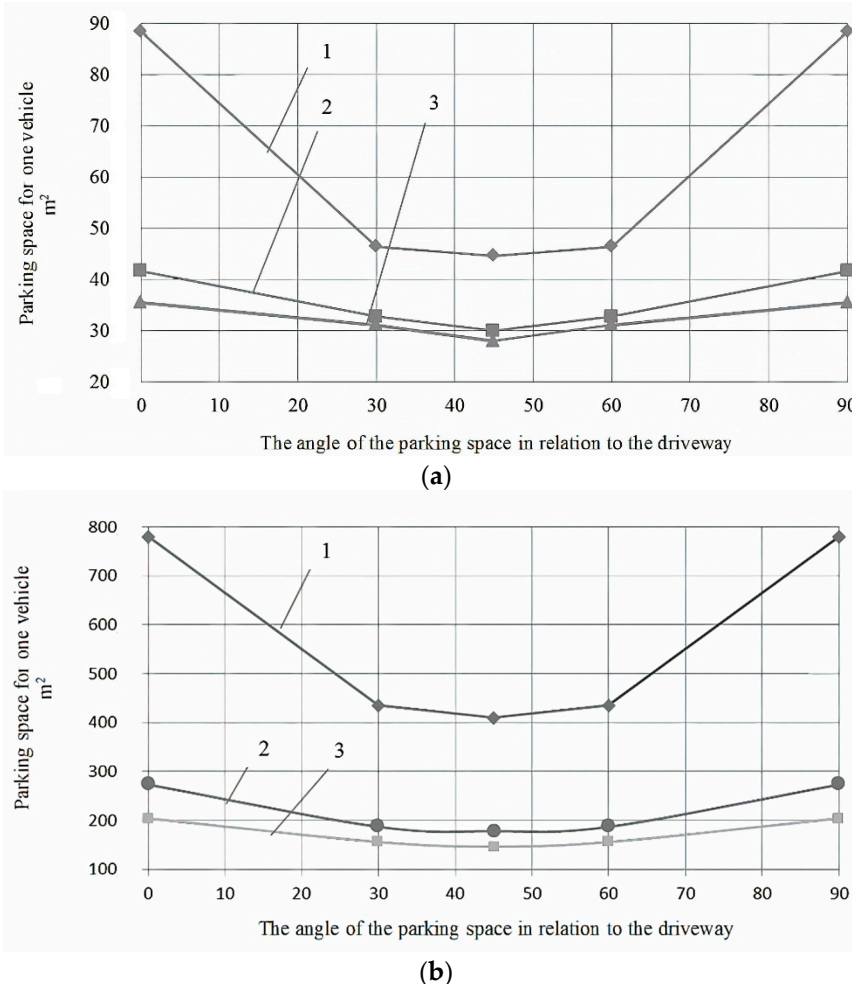

Figure 10. The required parking area at different angles of installation of vehicles and parking capacity: 1-one vehicle; 2-5 vehicles; 3-11 vehicles; (a) for passenger cars; (b) for road trains with the length of 16.5 m.

5. Results

Based on the conducted research the following types of design vehicles are recommended as the most frequently encountered ones on the roads: passenger car (P); city bus (CB); bus (B); articulated bus (AB); truck (T); road train consisting of a truck tractor and semi-trailer (A16); road train consisting of a truck and a trailer (A20). The main dimensions of the specified design vehicles are provided in Table 1. The template for the design of curves in the plan with the minimum radius of the design vehicle is provided in Figure 11. For each type of the design vehicle also the minimum turning radius that is provided in Table 2 was specified.

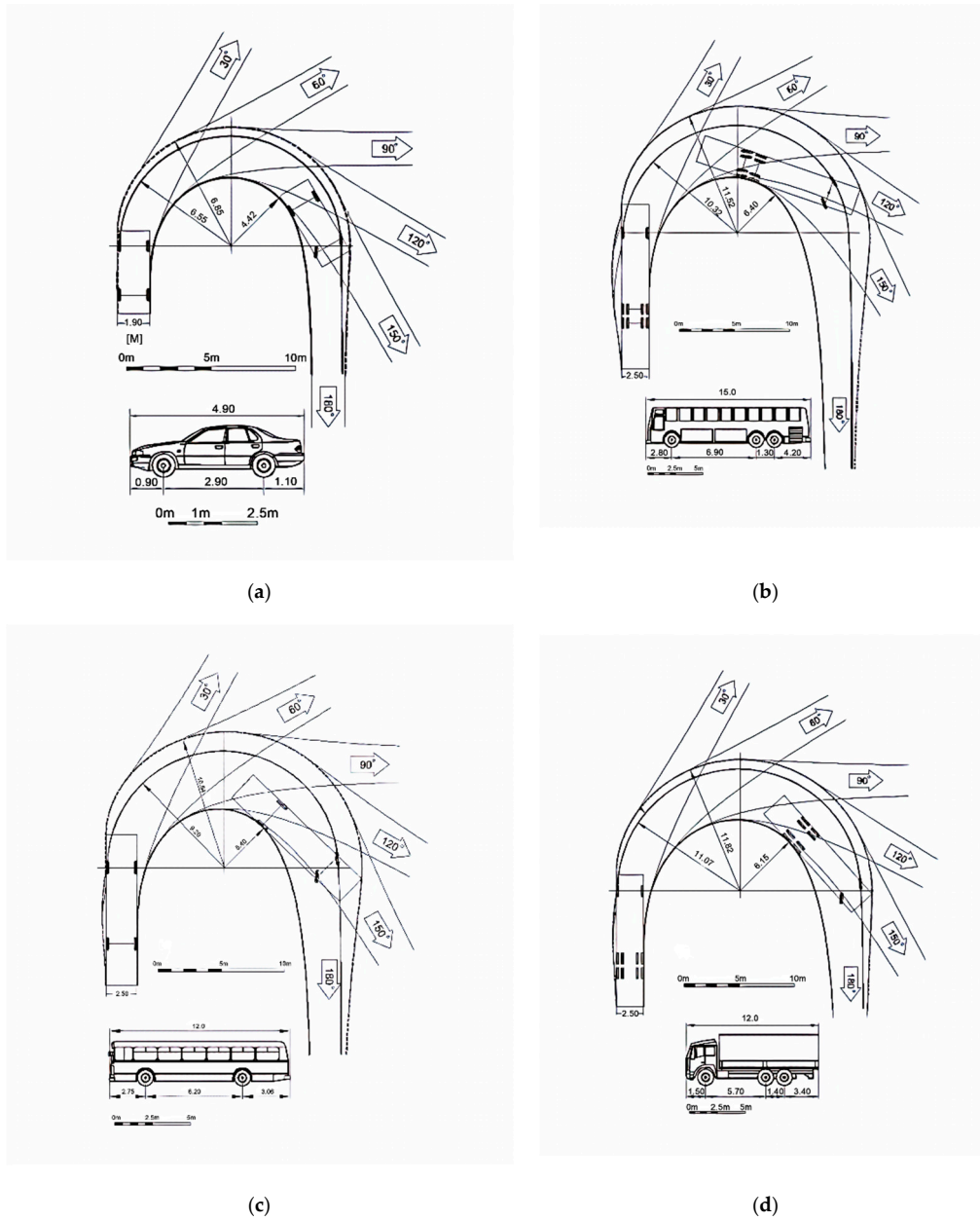

Figure 11. Cont.

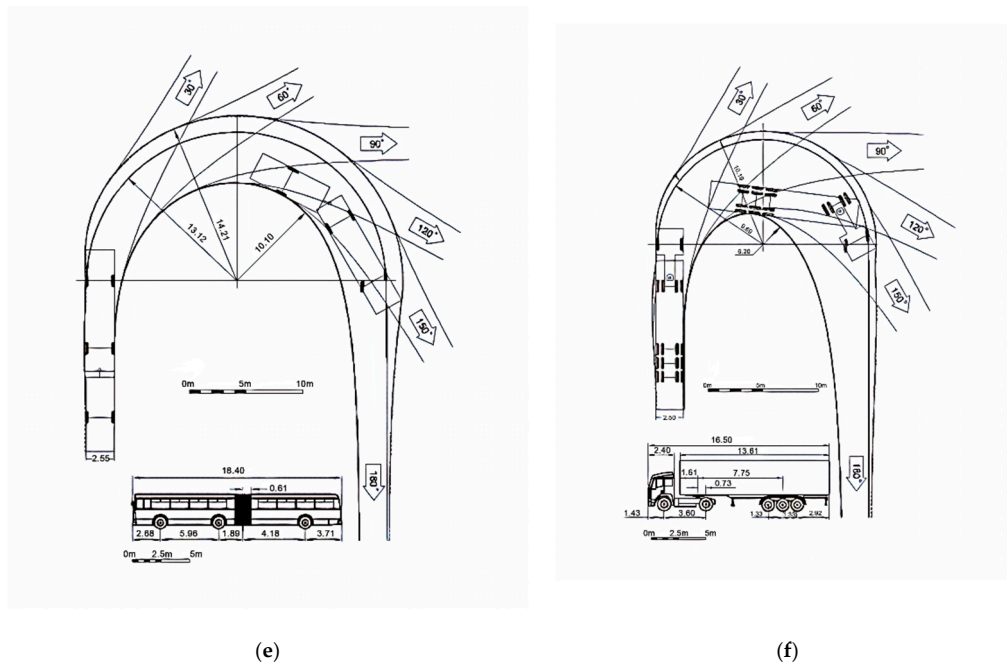

Figure 11. Template for the design of curves in the plan with the minimum radius of the design vehicle: (a) passenger car (P); (b) city bus (CB); (c) bus (B); (d) truck (T); (e) articulated bus (AB); (f) road train (A16) [42].

Table 1. Recommended size of design vehicles (see Figure 11).

Type of Design Vehicles	Designation		Wheelbase (m)	Dimension (m)			
	RD ⁽¹⁾	TR ⁽²⁾		General		Overhang	
				Length	Width	Front	Rear
Passenger Car	P	M ₁	2.90	4.90	1.90	0.90	1.10
City Bus	CB	M ₂	6.20	12.0	2.50	2.75	3.05
Bus	B	M ₃	6.90/1.30	15.0	2.50	2.60	4.20
Articulated Bus	AB	M ₃	5.96/6.05	18.4	2.55	2.68	3.71
Truck	T	N ₃	6.80	12.0	2.50	1.50	3.70
Road Train	A16	N ₃ + O ₄	3.80/7.02	16.50	2.50	1.43	2.98
Road Train	A20	N ₃ + O ₄	6.80/4.30	19.80	2.50	1.50	0.70

Note: RD ⁽¹⁾—vehicle designation adopted in the article, TR ⁽²⁾—designation of cars in accordance with the Technical Regulations “On the safety of wheeled vehicles” (approved by the decision of the Commission of the Customs Union of 9 December 2011 No. 877).

Table 2. Minimum turning radius of design vehicles (see Figure 11).

Type of Design Vehicles	Minimum Turning Radius (m)	Minimum Outer Radius (m)	Minimum Inner Radius (m)
Passenger Car (P)	6.55	6.85	4.42
City Bus (C)	9.20	10.54	5.40
Bus (B)	10.32	11.52	6.40
Articulated Bus (A)	13.12	14.21	10.10
Truck (T)	11.07	11.82	6.15
Road Train (A16)	9.69	10.19	6.20
Road Train (A20)	12.06	12.63	8.50

The resulting sizes of parking spaces and the scheme of their breakdown are provided in Table 3 and Figure 12. Recommended lengths of parking spaces for longitudinal placement of design vehicles are presented in Table 4. Recommended schemes and dimensions of parking of buses (a type of rated car B) with the longitudinal placement, saw tooth and a perpendicular device of aprons are shown in Figure 13. Considering the foreign experience of organizing parking spaces for large-sized vehicles, which provides entry and exit from the parking without reversing (Figure 14), and resulting from the research it is recommended to take the dimensions of parking spaces in accordance with the values in Table 5.

Table 3. Size of parking elements and average areas of one parking space.

Vehicle Installation Angle (Degree)	Sizes of Elements (m)									Average Area for 1 Vehicle (m ²)	
	A	B	C	D	E	F	G	H	I	without	with
	2	3	4	5	6	7	8	9	10	Manoeuvring	12
One-way car parking (P)											
90	5.0	7.0	17.0	11.5	0.5	6.0	2.5	2.5	0.5	12.5	28.7
60	5.2	4.2	14.6	8.9	0.5	3.2	2.5	2.9	0.5	15.1	25.8
45	4.8	4.0	13.6	8.3	0.5	3.0	2.5	3.5	0.5	16.8	29.0
Two-way car parking (P)											
90	5.0	8.0	18.0	12.5	0.5	7.0	2.5	2.5	0.5	12.5	22.5
60	5.2	5.2	15.6	9.9	0.5	4.2	2.5	2.9	0.5	15.1	22.6
45	4.8	5.0	14.6	9.3	0.5	4.0	2.5	3.5	0.5	16.8	25.5
Truck parking (T)											
90	13.0	16.1	42.1	28.6	0.5	15.1	3.5	3.5	0.5	45.5	100.1
60	11.8	12.4	36.0	23.7	0.5	11.4	3.5	4.0	0.5	47.2	94.8
45	10.5	8.7	29.7	18.7	0.5	7.7	3.5	5.0	0.5	52.5	93.5
City bus parking (CB)											
90	13.0	16.1	42.1	28.6	0.5	15.1	3.5	3.5	0.5	45.5	100.1
60	11.8	12.4	36.0	23.7	0.5	11.4	3.5	4.0	0.5	47.2	94.8
45	10.5	8.7	29.7	18.7	0.5	7.7	3.5	5.0	0.5	52.5	93.5
Bus parking (B)											
90	16.0	19.0	51.0	34.5	0.5	18.0	3.5	3.5	0.5	56.0	120.7
60	14.3	16.1	44.7	29.9	0.5	15.1	3.5	4.0	0.5	57.2	119.6
45	12.4	11.7	36.5	23.6	0.5	10.7	3.5	5.0	0.5	62.0	118.0
Articulated bus parking (AB)											
90	19.5	25.1	64.1	44.1	0.5	24.1	3.5	3.5	0.5	68.3	154.3
60	17.3	20.3	54.9	37.1	0.5	19.3	3.5	4.0	0.5	69.2	148.4
45	14.9	18.5	48.3	32.9	0.5	17.5	3.5	5.0	0.5	74.5	164.5
Road train parking (A16)											
90	17.5	23.9	58.9	40.9	0.5	22.9	3.5	3.5	0.5	61.3	143.1
60	16.6	18.9	52.1	35.0	0.5	17.9	3.5	4.0	0.5	66.4	140.0
45	13.5	17.4	44.4	30.4	0.5	16.4	3.5	5.0	0.5	67.5	152.0
Road train parking (A20)											
90	21.0	33.0	75.0	53.5	0.5	32.0	3.5	3.5	0.5	73.5	187.2
60	18.6	23.8	61.0	41.9	0.5	22.8	3.5	4.0	0.5	74.4	167.6
45	16.0	21.1	53.1	36.6	0.5	20.1	3.5	5.0	0.5	80.0	183.0

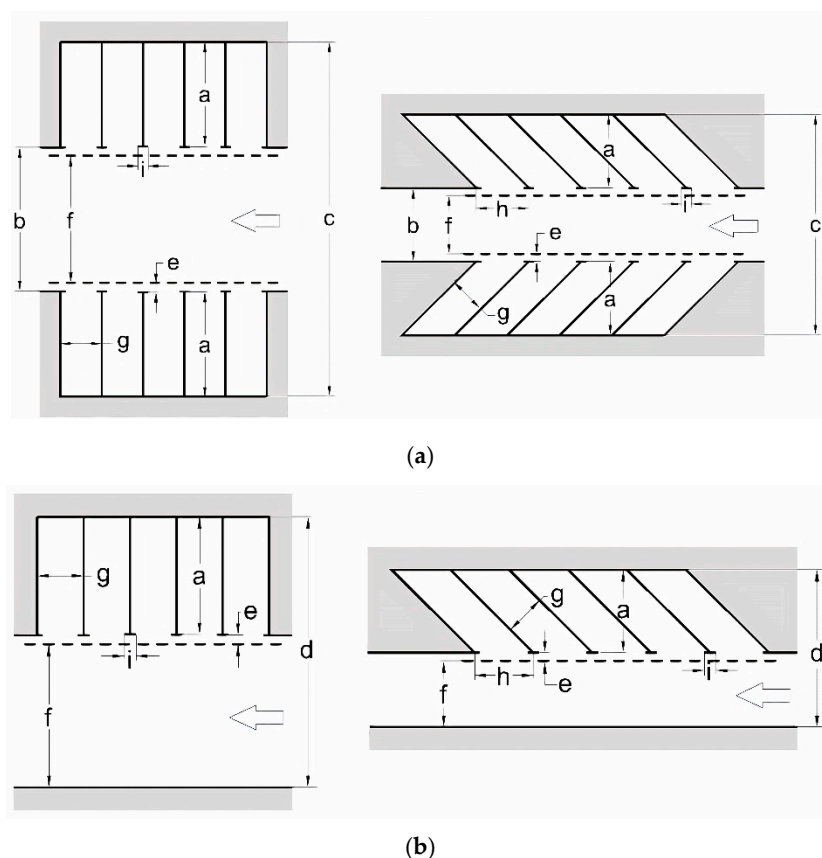
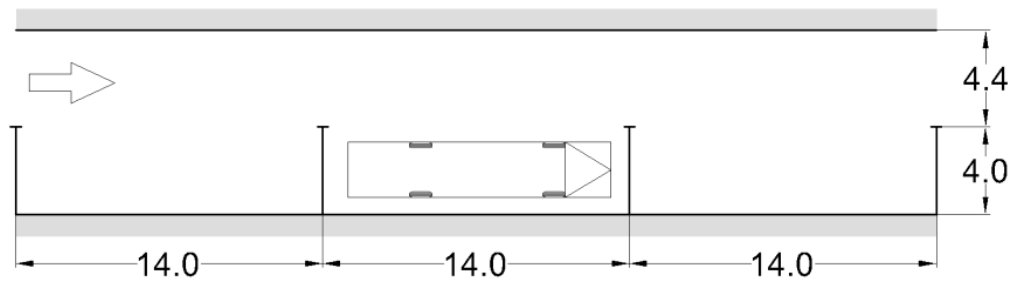

Figure 12. Possible layouts of the parking space: (a) two-side parking; (b) one-side parking; a—the depth of the parking space; b—the width of the passage between the rows of parking spaces; c—the distance occupied by the strip for parking and manoeuvring; d—the distance occupied by the strip for parking and travel; e—security band; f—manoeuvring strip; g—the width of the parking place; h—the width of the parking module; i—mark-up line length.

Table 4. The length of parking spaces for longitudinal design vehicles.

Design Vehicle	Passenger Car (P)	Truck (T)	Buses			Road Train	
			(CB)	(B)	(AB)	(A16)	(A20)
Parking space length (m)	6.0	14.0	14.0	17.0	22.5	20.0	24.0

For highways, where trucks and road trains predominate as part of the traffic flow, it is recommended to plan parking spaces with a transverse arrangement so the trucks do not need to effectuate a turning manoeuvre or movement with minimum radii. The design of the diagonal parking may vary depending on the angle at which the vehicles are located. To determine the size of the diagonal parking spaces for trucks, a design vehicle model was created and it modelled the movement path of the design vehicle, and it also determined the dynamic size. With this in mind, the main dimensions of the car park were determined (Figure 15). Using the approach above, diagonal parking sizes were determined at an angle from 30° to 45°. The planning of the parking space includes an alternative placement of parking spaces within the car park and modelling using the dynamic dimensions of the design vehicle at entrances and exits from the parking space. A necessary element of the organisation of traffic in the car park and the design of parking space is the organisation of an unimpeded passage of vehicles past parking spaces with a width of 4.5 m. The minimum radius for entering the car park should be at least 26 m, and at the exit it should be at least 30 m. The dimensions of parking spaces at different parking angles are presented in Table 5.



(a)

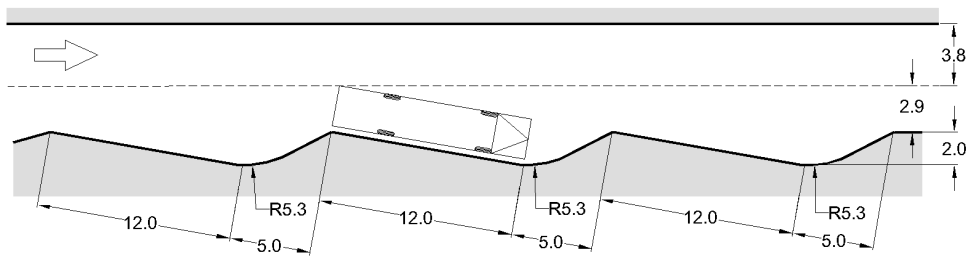

(b)

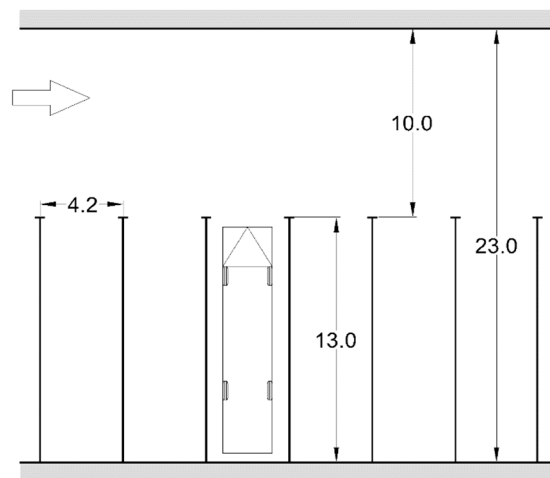

(c)

Figure 13. The scheme of parking spaces for city buses: (a) when parallel; (b) saw tooth; (c) a perpendicular placement in relation to the driveway or manoeuvring zone.

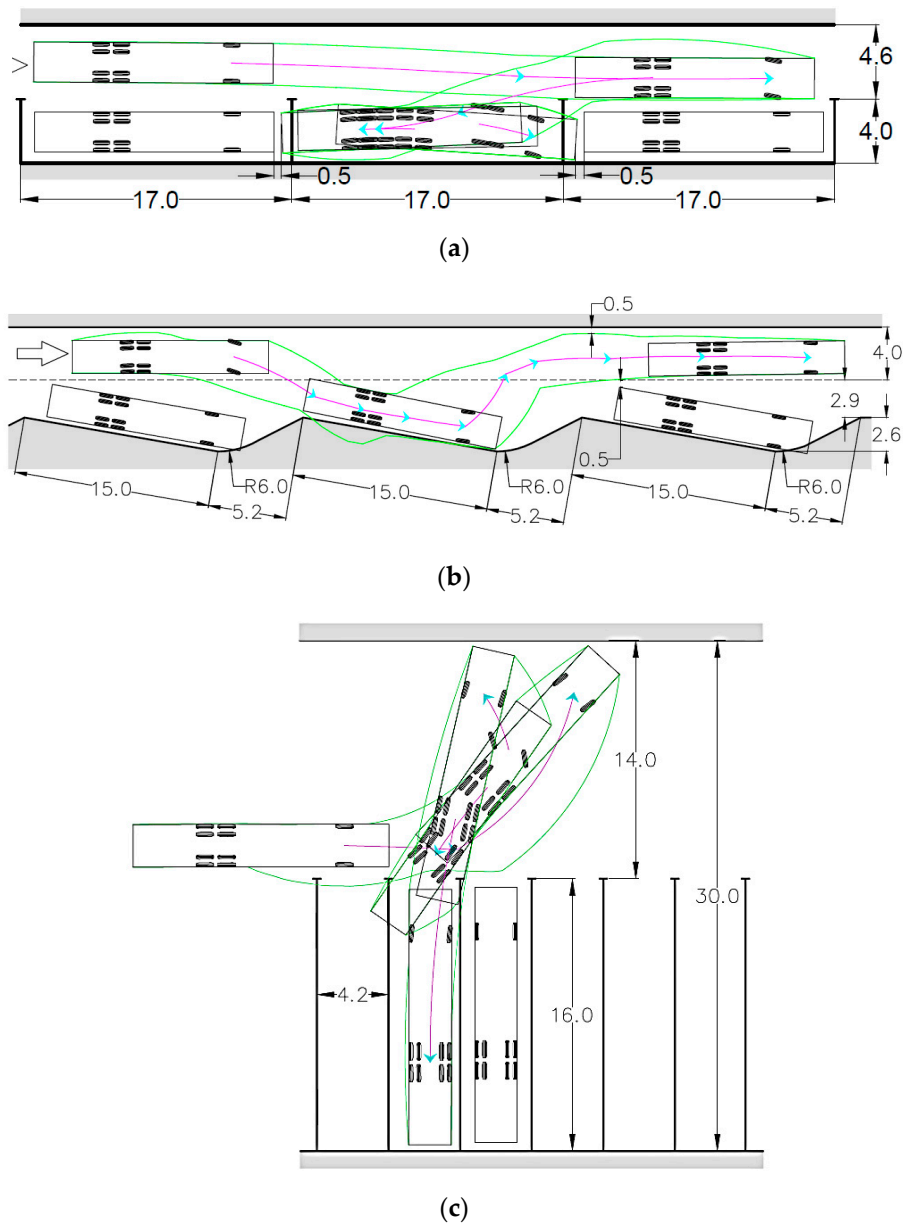

Figure 14. Scheme and dimensions of parking spaces for a bus: (a) when parallel; (b) saw tooth; (c) a perpendicular placement in relation to the driveway or manoeuvring zone (similar scheme is proposed for other types of buses).

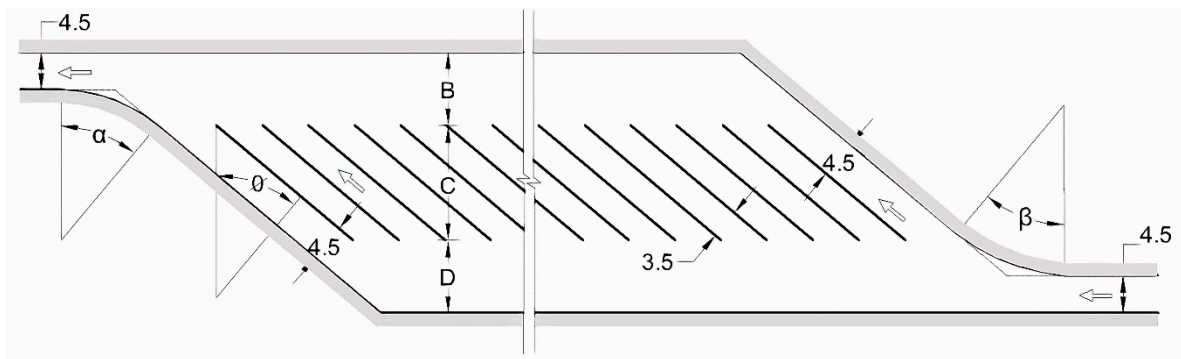

Figure 15. Elements of breakdown of the parking space for trucks: α – β —parking angle; θ —vehicle installation angle; B–D—manoeuvring strip; C—parking module length.

Table 5. Sizes of parking spaces at different corners of the parking of trucks (see Figure 15).

Set Angle (Degree)		Sizes of Parking Spaces (m) (See Figure 9)			
\emptyset	α	β	B	C	D
A 16					
30	30	30	7.5	12.0	7.5
35	35	35	8.5	13.0	8.5
40	40	40	8.7	13.5	8.7
45	45	45	9.5	15.5	9.5
A 20					
30	30	30	8.0	13.0	8.0
35	35	35	9.0	15.5	9.0
40	40	40	9.2	16.5	9.2
45	45	45	10.0	17.7	10.0

6. Conclusions

By studying the size of parking places, it was found out that the recommended dimensions provided by previously adopted regulatory documents do not comply with the existing traffic flow in the twentieth century. Regulatory documents contained ambiguous, sometimes even contradictory information, which is in conflict with the objectives of road safety and its convenience.

The “Methodological recommendations on the design and equipment of highways to ensure traffic safety” [24] recommend the approximate calculation of the total area of coverage in a parking place, including the area of manoeuvring the average area per one passenger car of 25 m², and per truck of 40 m². In the album of typical projects “Cross-sectional profiles of highways passing through settlements” (TP503-0-47.86), the average parking area for a truck should be 92.4 m², not 40 m², as stated in the methodological recommendations.

The dimensions of parking places recommended by the authors differ from the current regulatory documents in the direction of increasing the area for the parking space. This is due to the fact that modern vehicles are wider and longer and require more space for parking and manoeuvring. Researches have shown that for one passenger car, while taking into account the manoeuvring, 28.7 m² of parking space is needed. For a road train with the length of 16.5 m, this value is 143.1 m² of area, and for a road train with the length of 19.8 m, this value is 187.2 m² of area, which are substantially higher values than defined by regulatory documents.

Based on the research two basic conclusions can be presented. Less than five parking places at an angle of 90° are inefficient for any type of vehicle regarding the area used. When parking places are located at the angle of 60° or 45°, up to four parking places are considered to be inefficient regarding the area used.

Despite the fact that the presented research took into account the characteristics of the traffic flow in Russia, its results can be applied to different environments taking into consideration different design vehicles. The methodology of the research is general and applicable also to other countries. The results, however, depend on the dimensions of design vehicles, which are influenced by maximum allowable dimensions of vehicles in individual countries. Therefore, the design vehicles in Russia and Uzbekistan are different from those in the USA, for instance. The results can be used in EU Member States after slight modifications because the dimensions of design vehicles in the paper are very similar to maximum allowed dimensions of vehicles and vehicle combinations according to the Council Directive 96/53/EC.

The research problematics is very relevant because of the need to meet requirements of the EU regulations related to the mandatory weekly and daily rests of truck drivers that are remotely controlled by smart tachographs installed in all newly registered freight vehicles in EU Member States from June 2019. This would be very difficult without a sufficient number of suitable parking areas.

The provided recommendations can be useful also for designing parking in open areas near shopping centres, state institutions, universities, the custom controls, driver rest areas (many functional recreation areas) and other suitable open areas. All these are part of smart parking systems in today's Smart Cities.

Author Contributions: Conceptualization, M.M.; methodology, M.M.; software, J.A.; validation, J.A., J.Z. and M.M.; formal analysis, J.Z.; investigation, J.A.; resources, J.A.; data curation, J.A.; writing—original draft preparation, J.A.; writing—review and editing, J.Z. and J.J.; visualization, J.A.; supervision, M.M.; project administration, M.M.; funding acquisition, M.M. All authors have read and agreed to the published version of the manuscript.

Funding: This paper was supported by the Project 586292-EPP-1-2017-1-PL-EPPKA2-DBHE-JP—INTRAS—Intelligent Transport Systems: New ICT-based Master's Curricula for Uzbekistan, co-funded by the ERASMUS+ scheme under grant agreement n. 2017-3516/001-001.

Conflicts of Interest: The authors declare no conflict of interest.

References

1. Highway Research Board. *Parking Principles*; Special Report 125; Highway Research Board: Washington, DC, USA, 1971; p. 217.
2. Homburger, W.S. *Transportation and Traffic Engineering Handbook*; Prentice-Hall: Upper Saddle River, NJ, USA, 1982; p. 883.
3. Young, W. Parking principles: Some thoughts on the design of parking lots. *Aust. Road Res.* **1987**, *17*, 132–136.
4. Westin, R.B.; Gillen, D.W. Parking location and transit demand: A case study of endogenous attributes in disaggregate mode choice models. *J. Econ.* **1978**, *8*, 75–101. [[CrossRef](#)]
5. Calthrop, E.; Proost, S. Regulating on-street parking. *Reg. Sci. Urban Econ.* **2006**, *36*, 29–48. [[CrossRef](#)]
6. Glazer, A.; Niskanen, E. Parking fees and congestion. *Reg. Sci. Urban Econ.* **1992**, *22*, 123–132. [[CrossRef](#)]
7. Khordagui, N. Parking prices and the decision to drive to work: Evidence from California. *Transp. Res. Part A Policy Pract.* **2019**, *130*, 479–495. [[CrossRef](#)]
8. Higgins, T.J. Parking taxes: Effectiveness, legality and implementation, some general considerations. *Transportation* **1992**, *19*, 221–230. [[CrossRef](#)]
9. Shoup, D.C. The high cost of free parking. *J. Plan. Educ. Res.* **2005**, *17*, 3–20. [[CrossRef](#)]
10. Gillen, D.W. Parking policy, parking location decisions and the distribution of congestion. *Transportation* **1978**, *7*, 69–85. [[CrossRef](#)]
11. Waraich, R.A.; Axhausen, K.W. Agent-based parking choice model. *Transp. Res. Rec.* **2012**, *2319*, 39–46. [[CrossRef](#)]
12. Callejas-Cuervo, M.; Valero Bustos, H.; Alarcon-Aldana, A. *Simulation Based on Systems Dynamics and Intelligent Agents*; Editorial Uptc: Tunja, Colombia, 2018; p. 112, ISBN 9789586602679.
13. Ottomanelli, M.; Dell'Orco, M.; Sassanelli, D. Modelling parking choice behaviour using possibility theory. *Transp. Plan. Technol.* **2011**, *34*, 647–667. [[CrossRef](#)]
14. Janak, P.; Pritikana, D.; Sanjaykumar, M.D. Study on demand and characteristics of parking system in urban areas: A review. *J. Traffic Transp. Eng.* **2020**, *7*, 111–124.
15. Arnott, R.; Rowse, J. Modeling parking. *J. Urban Econ.* **1999**, *45*, 97–124. [[CrossRef](#)]
16. Christiansen, P.; Engebretsen, O.; Fearnley, N.; Hanssen, J.U. Parking facilities and the built environment: Impacts on travel behaviour. *Transp. Res. Part A Policy Pract.* **2017**, *95*, 198–206. [[CrossRef](#)]
17. Inan, M.O.; Inci, E.; Lindsey, C.R. Spillover parking. *Transp. Res. Part B Methodol.* **2019**, *125*, 197–228. [[CrossRef](#)]
18. Gonzalez-Gonzales, E.; Nogues, S.; Stead, D. Parking futures: Preparing European cities for the advent of automated vehicles. *Land Use Policy* **2020**, *91*, 104010. [[CrossRef](#)]
19. Ngo, H.Q.T.; Nguyen, T.P.; Nguyen, H. Hardware Design for Intelligent IoT Approach to Optimize Parking Slots. In Proceedings of the 13th International Conference on Advanced Computing and Applications, ACOMP 2019, Nha Trang, Vietnam, 26–28 November 2019; pp. 171–175.

20. Chaudhary, G.; Agrawal, H.; Tirkey, S.; Nath, V. Study and Design of Smart City with Internet of Things: A Review. In Proceedings of the 4th International Conference on Nanoelectronics, Circuits and Communication Systems, NCCS 2018, Ranchi, India, 3–4 November 2018; Lecture Notes in Electrical Engineering 2020. Volume 642, pp. 533–545.
21. Silva, B.N.; Khan, M.; Han, K. Towards sustainable smart cities: A review of trends, architectures, components, and open challenges in smart cities. *Sustain. Cities Soc.* **2018**, *38*, 697–713. [CrossRef]
22. Jagelcak, J.; Kiktova, M.; Francak, M. The analysis of manoeuvrability of semi-trailer vehicle combination. In *LOGI 2019—Horizons of Autonomous Mobility in Europe*; Elsevier: Amsterdam, The Netherlands, 2020; pp. 176–181.
23. Information and Legal Portal Garant Web Site. Available online: <http://www.garant.ru/hotlaw/moscow/430F367> (accessed on 27 January 2018).
24. Buranov, I. Mayor shifted the burden of responsibility to the region. *Newspaper Kommersant*, 16 June 2012; Volume 218, p. 5003.
25. The Ministry of Internal Affairs of Russia. *Monitoring Compliance with the Norms, Rules and Standards when Designation and Construction of Roadside Facilities (Service Facilities)*; Methodical Recommendations; SIC STSI of the Ministry of Internal Affairs of Russia: Moscow, Russia, 2004; p. 28.
26. Rankin, V.U. Automobile transportations and the organization of traffic. *Transport* **1981**, 592.
27. ABaerwald, J.E. *Transportation and Traffic Engineering Handbook*, 3rd ed.; Institute of Traffic Engineers: Washington, DC, USA, 1965; p. 717.
28. Design and Equipment of Highways to Ensure Traffic Safety. Methodical Recommendations. *Transport* **1983**.
29. Regulations for the Placement of Multifunctional Road Zones of the Service on the Highways of the State Company “Russian Highways” (Approved by the Order of the State Company “Russian Highways” 24 June 2013, No. 114). Available online: http://www.rhighways.ru/for_investor/road_service/multifunctionalroad_service_area (accessed on 12 August 2018).
30. Pospelov, P.I.; Schit, B.A.; Abdunazarov, J.N. Designing of parking spaces on car parking. *Sci. Eng. Roads* **2016**, *2*, 6–10.
31. Iranpour, R.; Tung, D. Methodology for optimal design of a parking lot. Most land-use projects, factories, profess. *J. Transp. Eng.* **1989**, *115*, 139–160. [CrossRef]
32. Young, W. A review of parking lot design models. *Transp. Rev.* **2007**, *8*, 161–181. [CrossRef]
33. Leephakpreeda, T. Car-parking guidance with fuzzy knowledge-based decision making. *Build. Environ.* **2007**, *42*, 803–809. [CrossRef]
34. Maulana, M.F.; Adhy, S.; Bahtiar, N.; Waspada, I. Development of a smart parking system based on internet of things using object-oriented analysis and design method. *J. Phys.* **2020**, 1524. [CrossRef]
35. AutoTURN. Advanced Vehicle Simulations. Available online: <http://store.softline.ru/transoft/transoft-autoturn> (accessed on 18 September 2018).
36. Help for Guests. Guidelines. Available online: <http://www.gosthelp.ru> (accessed on 18 September 2018).
37. Ministry of International Affairs of Russia. *The Methodical Recommendations on Designing and Equipping the Highways for Road Safety*; Ministry of International Affairs of Russia: Moscow, Russia, 1983.
38. Abnunazarov, J.; Mikusova, M. Testing trajectory of road trains with program complexes. *Arch. Automot. Eng. Arch. Motoryz.* **2019**, *83*, 103–112. [CrossRef]
39. Mikusova, M.; Abnunazarov, J. Modelling of vehicles movements for the design of parking spaces. In Proceedings of the International Conference on Computational Collective Intelligence (ICCCI), Hendaie, France, 4–6 September 2019. Part II, LNCS 11684, in press.
40. Abdunazarov, J.N. Justification of the parameters design vehicle. In *Collection of Materials of the III All-Russian Road Congress*; Publishing House NGTU: Moscow, Russia, 2013; pp. 122–131.
41. Abdunazarov, J.N. Modeling of the movement of the design vehicles on parking space. *Sci. Eng. Roads* **2018**, *84*, 10–11.
42. Abdunazarov, J.N.; Mamarasulova, M.N. Recommended parameters of design vehicles for the Russian Federation. *Young Sci.* **2016**, *7.2*, 26–28.

