

DIAGNOSTICS OF ZnO VARISTORS BY MEANS OF NONDESTRUCTIVE TESTING

Lech HASSE¹, Janusz SMULKO¹, Marek OLESZ², Vlasta SEDLÁKOVÁ³, Josef ŠIKULA³,
Petr SEDLÁK³

1. Gdansk University of Technology, Faculty of Electronics, Telecommunications and Informatics
G. Narutowicza 11/12, 80-233 Gdansk, tel.: 48 58 347 1884, fax: 48 58 341 6132, e-mail: hasse@eti.pg.gda.pl
2. Gdansk University of Technology, Faculty of Electrical and Control Engineering
G. Narutowicza 11/12, 80-233 Gdansk, tel.: 48 58 347 1820, fax: 48 58 347 2136, e-mail: m.olesz@ely.pg.gda.pl
3. Brno University of Technology, Faculty of Electrical Engineering and Communication
Technická 3058/10, 616 00 Brno, tel.: 420 54114 3398, fax: 420 541 143 133, e-mail: sedlaka@feec.vutbr.cz

Summary: Standard industrial testing of high-voltage varistors for surge arresters demands application of high voltages and intensive currents. Nondestructive methods for varistor quality and endurance evaluation have been proposed and described. They rely on the application of resonant ultrasound spectroscopy, electro-ultrasonic spectroscopy, noise measurement and nonlinearity testing at voltages lower than continuous operating range. The achieved results show that these methods could be successively applied for varistor specimens at the production stage and in laboratory circumstances.

Keywords: varistor, diagnostics, nondestructive testing

1. INTRODUCTION

ZnO varistors are widely used as surge arresters in electrical networks and electronic systems limiting overvoltage disorders caused by lightning or other electrical shocks. High quality varistors are characterised by strongly nonlinear resistance that depends on technology and materials used during preparation process. In the current-voltage characteristic of a high-voltage varistor three regions can be distinguished: pre-breakdown, breakdown and saturation.

At a breakdown region the current I is nonlinearly proportional to the applied voltage U :

$$I = a \cdot U^\alpha \quad (1)$$

where: a – constant depending on varistor type. The nonlinearity exponent α (a measure of characteristics curve nonlinearity) depends on a type of boundary junctions between grains in a structure.

The varistors applied in surge arresters should exhibit a high value of a parameter α . There are nonlinear (proper for surge arresters), low nonlinear and linear junctions depending on the ZnO grains (Fig. 1). These various types of intergranular contacts can be discriminated by the voltage-current characteristics. A characteristics of a varistor as a

mixture of various contacts depends on amount of grain types in its structure. The presence of linear or weakly nonlinear grain contacts decreases α and diminishes desirable nonlinear varistor characteristic at its relatively low voltage region.

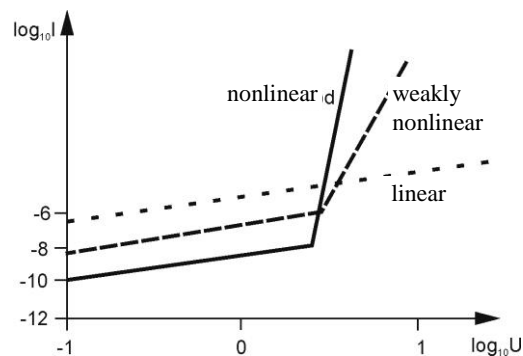

Fig.1. Approximated current-voltage characteristics of the distinguished types of boundary junctions between grains.

Varistors during production can be tested by a measurement of their leakage current, checking their ability of conducting intense current pulses. Industrial standards recommend leakage current measurements at DC voltage about 400V or at high voltage impulses that cause intensive current flows mainly through narrow paths of grains with linear (ohmic) junctions. High current density and intensive heating can cause irreversible destruction of the tested varistor. During measurements the following nondestructive testing (NDT) methods could also be used: Resonant Ultrasound Spectroscopy (RUS), determining parameters correlated with the types of structure grains (e.g. frequencies of their mechanical resonances occurring during ultrasound excitation), Electro-Ultrasonic Spectroscopy (E-US), noise or nonlinearities measurements [1]. They were applied in our experiments.

2. VARISTOR SAMPLES

Zinc oxide (ZnO) varistors contain usually a homogeneous distribution of a small amount of various dopants - other metal (e.g. bismuth, cobalt, manganese) oxides in the ZnO mixed powder, well-chosen by a producer. The mixture of that is usually cylindrically shaped in a press (Fig. 2), and fired later at a high temperature above 1000°C, when ZnO aggregates into grains. The firing is the most important step in the process and strongly affects the electrical properties of the varistor. The aggregated grains form a structure which determine the current-voltage characteristics of varistors. The structure of grains in tested specimens was preliminary observed by means of an Atomic Force Microscope (AFM) with a scanning probe enabling to obtain of 3D images of scanned surfaces (Fig.3). The well-prepared specimens comprise relatively large grains that have the non-linear characteristics of junctions between them (Fig. 3a). Smaller grains are characterized by more linear (grains having ohmic contacts) characteristics (Fig. 3b). It is strongly recommended to produce varistors having almost exclusively non-linear contacts between grains.



Fig. 2. Varistor specimens: a – structures after being fired (top) and with a metalized contacts (bottom); left – 280 V, middle – 440 V, right – 660 V; b - surge arrester with varistors.

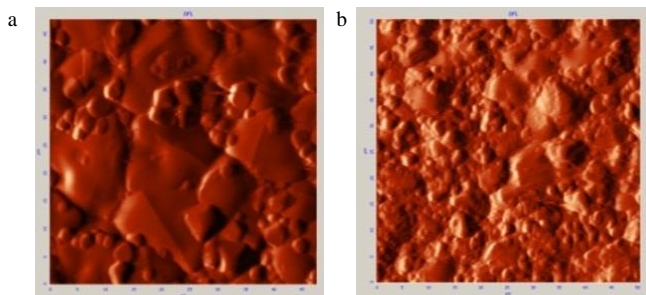

Fig. 3. Varistor structures in microscopic view (square area of size 50 μm × 50 μm): a - well-prepared with large grains; b - poor quality with smaller grains.

The varistor structure is influenced by working and environmental conditions like lighting or overvoltage spikes, together with excessive humidity. These factors can reduce nonlinearity of the grain junctions and influence their ageing processes that lead to cracks, conducting paths formations or changes in grains which reduce nonlinearity of their current-voltage characteristics.

Two groups of samples for the mentioned voltage thresholds were prepared for the experimental studies. There was a significant difference between proportions of linear and nonlinear grain junctions in each group as a result of changes introduced artificially into the prepared structures (Fig. 3), having impact on their current-voltage characteristics. This group of structures could be treated as a group of poor quality varistors – with a higher leakage current.

Some NDT methods require a current flow through the structures, therefore electrode layers were subsequently mounted at the top and the bottom surfaces of the half of samples for each group.

3. RESONANT ULTRASOUND SPECTROSCOPY

Resonant ultrasound spectroscopy is known as an acoustic, nondestructive technique used to study the elastic properties of various materials [2]. A free oscillating body can sustain vibrations at a series of resonant frequencies that are characteristic for various vibration modes. The resonant frequencies are related to the elastic constants and sample geometry. It enables to measure natural frequencies of free elastic vibrations of a simply shaped specimens. A typical measurement relies on scanning a selected frequency range including the appropriate resonances of the measured specimens [3]. Using this method it is possible to measure resonant frequencies and frequency responses even for small samples.

To prevent from detecting spurious resonances that can appear due to mechanical and electrical coupling in the measurement system, the Finite Elements Method (FEM) modelling of the tested object was used. The measured varistor discs were modelled using elastic constants corresponding to ZnO. Shapes of the two lowest resonance modes for a varistor on nominal voltage 280 V are shown in Fig. 4 [4].

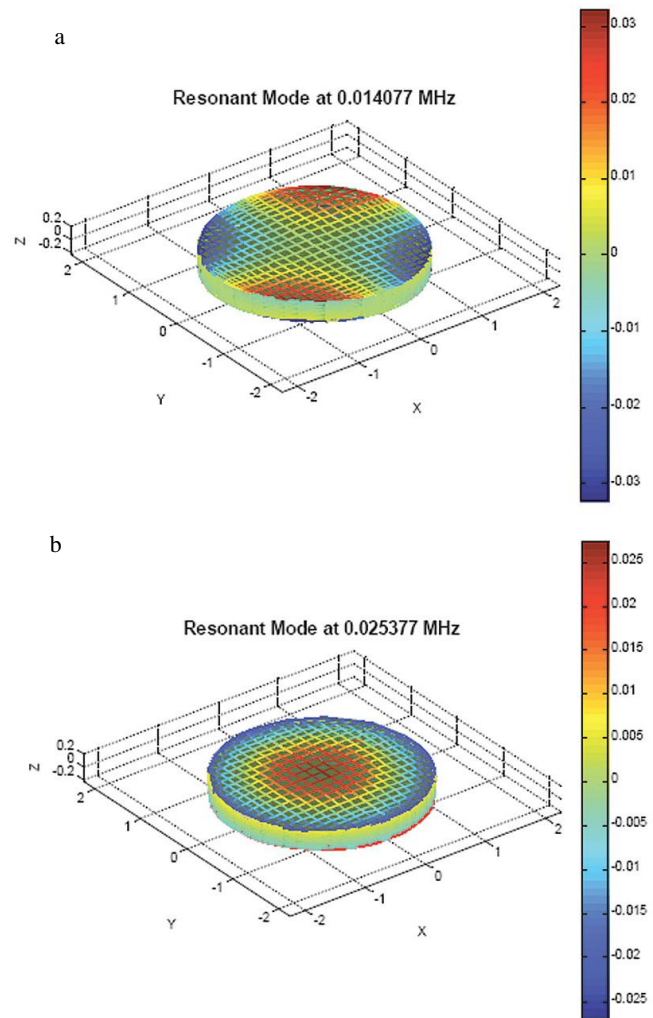

Fig. 4. First two resonance modes calculated for the 280 V varistor:
 a – at 14.077 kHz, b – at 25.377 kHz.

It should be noted that proper identification of the lowest modes is particularly important for the RUS procedure proposed by Migliori [5].

Measurements were performed in the prepared measurement system (Fig. 5) that consisted of two piezoelectric transducers (transmitter and receiver), a low-noise voltage amplifier, a data acquisition NI PCI 6132 and a generator NI PCI 5406 cards.

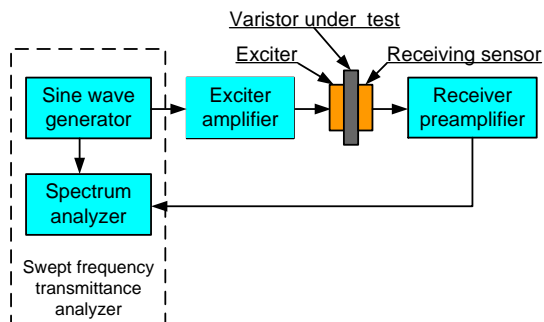

Fig. 5 Simplified block diagram of system for RUS of varistors.

Signals of both sensors were amplified by two independent amplifiers; the receiving preamplifier was working as a charge amplifier (its inherent noise should be negligible). A computer controlled the system during data acquisition by the prepared virtual instrument using LabVIEW software (Fig. 6). The system generated a harmonic signal at a given frequency and measured the amplitude of the vibrating ZnO structure that was placed between the transmitter and the receiver. The tested sample was held close by a conical ending of the receiving sensor. The system measured varistor vibrations within the frequency range up to 350 kHz by sweeping the frequency of the generated harmonic with a resolution below one Hz. The tested sample was put in an aluminium box covered inside with cork and was held by the transducers (Fig. 7).

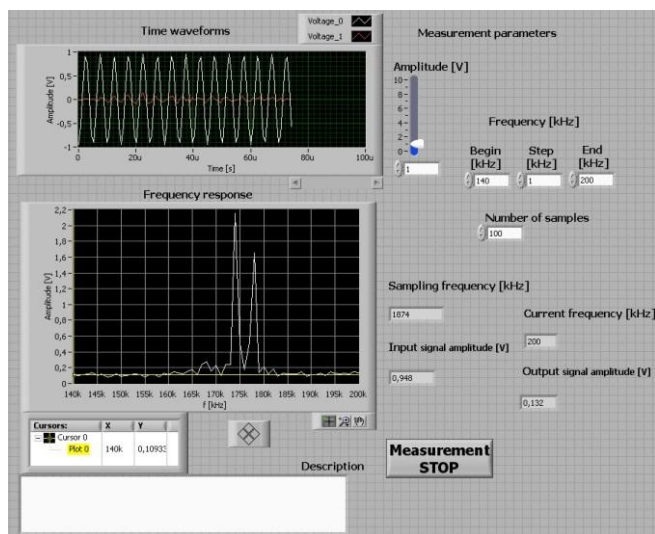

Fig. 6. Front panel of virtual instrument for measurement system control.

Taking into account the frequencies of different elastic modes of varistors and the results of preliminary measurements, the appropriate resonance frequencies was chosen to select during testing good and poor quality

samples: 175 kHz, 153 kHz and 130 kHz, for specimens 280 V, 440 V and 660 V, respectively. The exemplary resonance spectrum for sample 440 V No. 440-29A is shown in Fig. 8.

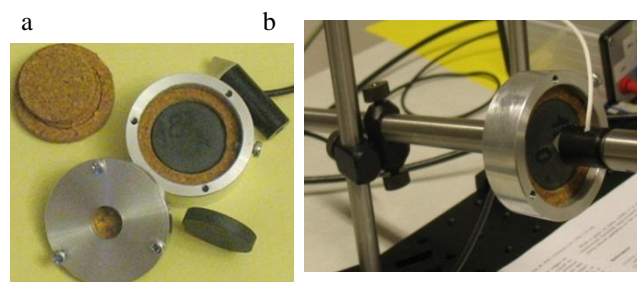

Fig. 7. Mechanical parts of RUS system: a – metallic shielding box with cork surrounding measured varistor, b – handle of the box.

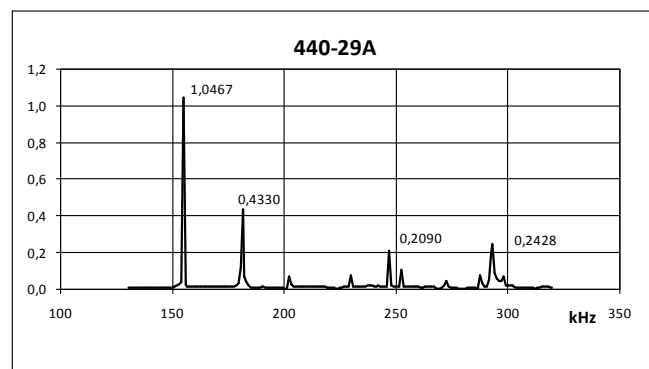

Fig. 8. Spectrum of resonances for sample 440-29A.

Generally, a varistor resonance frequencies have been shifted to the lower frequency range for samples with a poor quality.

A homogeneity parameter Q as a criterion of sample selection during industry production has been proposed. The parameter Q was evaluated on the basis of the values of resonant frequency f_r and actual dimensions of a tested disc-shaped varistor structures:

$$Q = f_r \sqrt{(w^2 + d^2)} \quad [\text{Hz} \cdot \text{m}] \quad (2)$$

where: w – thickness and d – diameter of a varistor. The parameter Q can be interpreted as proportional to an average sound velocity within a varistor structure and dependent on its quality (homogeneity).

The collective statistical results of the Q value for the 100 samples 440V are shown in Fig. 9 [3].

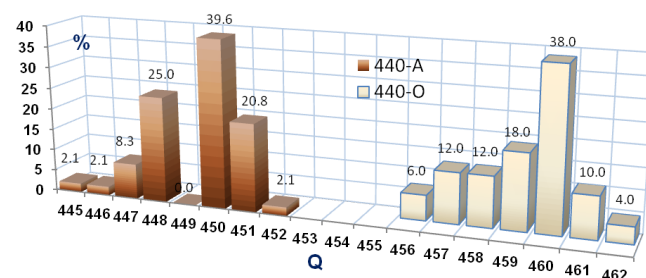

Fig. 9. Statistical (in percentage of samples) shift of parameter Q to the lower values for 440 V samples with poor quality (440-A – poor quality, 440-O – good quality).

A good separation between good and defected samples has been achieved. Therefore the proposed parameter Q proved to be a good criterion for the selection into groups of good and poor quality components [6].

4. ELECTRO-ULTRASONIC SPECTROSCOPY

The new method of the non-destructive testing of varistors based on the non-linear electro-ultrasonic spectroscopy using interaction between charge carriers during their transport and ultrasonic wave has been proposed [7]. Applying ultrasonic signal with frequency f_U and harmonic AC electric signal of frequency f_E to a varistor sample, ultrasonic phonons modulate the transport of electrons (impact on electron mobility) through the structure and in the vicinity of defects and inhomogeneities the intermodulation signal at $f_m = f_U - f_E$ is created. Proposed method is characterized by lower influence of elastic wave reflection and interference on measured signal due to that ultrasonic and electrical signals are different physical origin. High sensitivity of this method is based on the detection of electrical signal with frequency different from frequencies of excitation signals. The values of frequencies of the electric signal and the ultrasonic signal in the experiment were chosen so that the intermodulation signal was measured on frequency $f_m = 2$ kHz (Fig. 10). The dependences of the intermodulation amplitude A_m on the electric excitation for different values of ultrasonic excitation is shown in Fig. 11, on the ultrasonic excitation for the electric excitation $U_E = 50$ V is shown in Fig. 12.

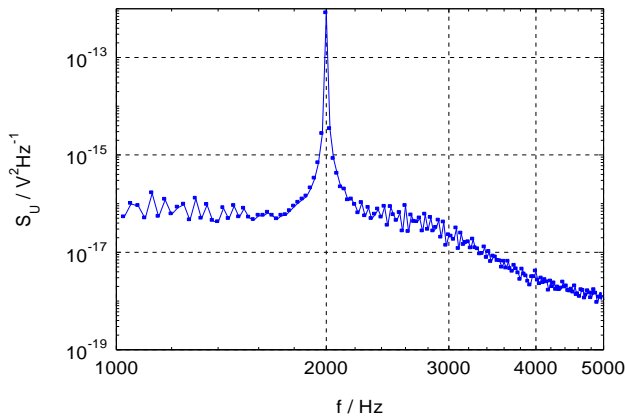

Fig. 10. Signal spectral density of a varistor sample; measuring system background noise $S_U = 10^{-16} \text{ V}^2 \text{ Hz}^{-1}$; $f_E = 33.4$ kHz, $U_E = 50$ V; $f_U = 31.4$ kHz, $U_U = 20$ V; sampling frequency $f_{vc} = 50$ kHz.

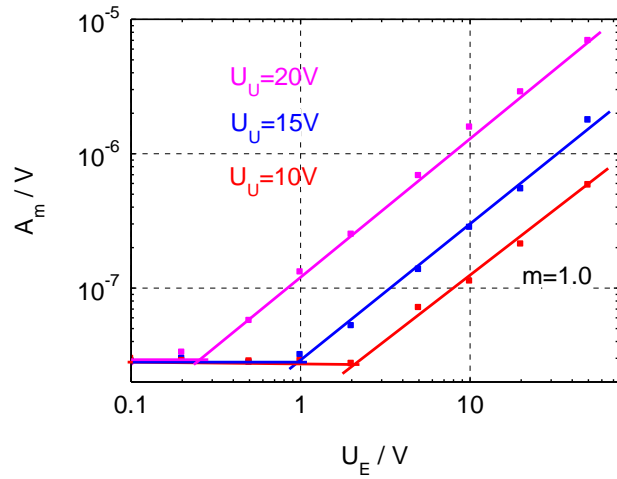

Fig. 11. The amplitude A_m vs. amplitude of U_E .

The intermodulation amplitude A_m increases linearly with electric excitation and approximately with the third power of ultrasonic excitation. The dependence of the intermodulation amplitude A_m on the ultrasonic excitation reveals the saturation. For given electric excitation the saturation occurred for the lower value U_U for the sample with poor quality. For given electric and ultrasonic excitation the value of A_m can be an indicator of the sample quality.

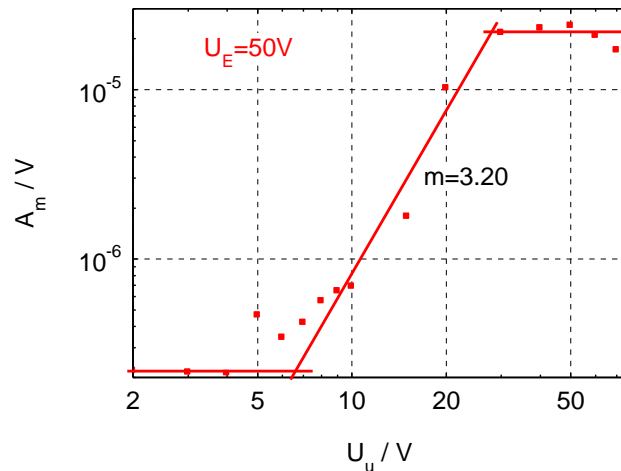

Fig. 12. The amplitude A_m vs. amplitude of U_U .

5. LOW-FREQUENCY NOISE MEASUREMENT

The noise spectroscopy is the promising method for non-destructive characterisation of tested object quality [8]. Most of failures result from defects and imperfections created during the manufacture processes. The sensitivity of excess noise to those defects is the main reason of using the noise as a diagnostic and prediction tool in reliability physics for quality assessment. The noise spectral density depends on homogeneity and manufacturing quality of the device active region and the sensitivity of noise characteristics to the structural irregularities is the basic feature of the method.

The block diagram of the noise measurement system is shown in Fig. 13. For high-voltage varistors the noise measurements were possible when the specimen bias voltage was not less than 400 V and the flowing current enabled of noise generation have a measurable level [9].

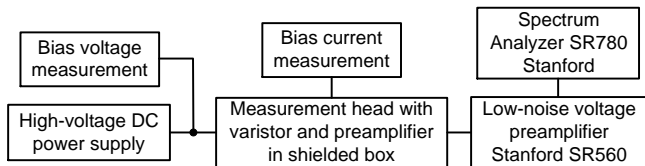

Fig. 13. General block diagram of noise measurement system.

The current noise power spectral density for varistors 440 V polarized by the current 100 μA is shown Fig. 14.

Typically, for measured varistors the $1/f^{\alpha}$ noise was observed in the frequency range up to several kHz. For higher frequencies the white noise became dominating.

Power spectral density of current fluctuations $S_I(f)$ was proportional to the current I_{DC} squared for all measured varistors. Significant differences in noise level (up to 40 dB) for particular samples, was observed. They reflected significant differences in the static current-voltage characteristics. The level of system background noise was no higher than $2 \cdot 10^{-26} \text{ A}^2/\text{Hz}$ in the low frequency range. It can be seen, that the inherent noise of measured varistors polarized above 300 V was several order higher than the level of system noise.

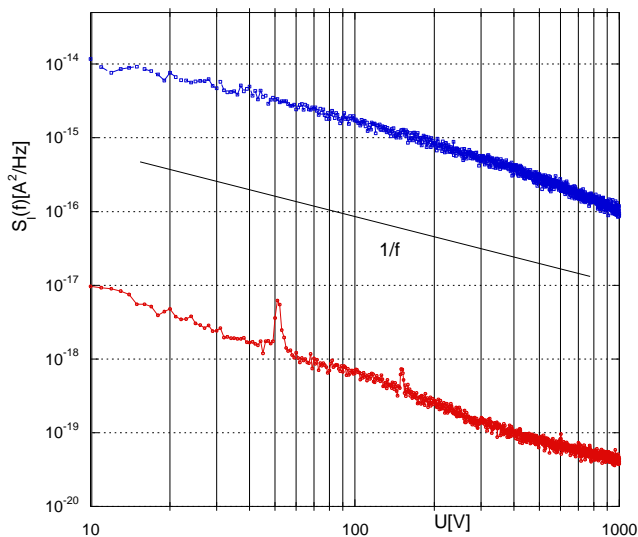

Fig. 14. Power spectral density of current noise for 440 V varistor samples (blue – poor quality, red – good quality samples).

The noise spectroscopy is very sensitive tool for identification of a varistor structure with different ZnO grain types enabling to detect varistors with poor quality and endurance.

6. NONLINEARITY TESTING

A differences in grain varistor structures have impact on its DC current-voltage characteristics. The Third Harmonic Index (THI) was measured at small currents that flow through the varistor excited by a harmonic signal at voltage amplitude up to 100 V [10]. Such tests demand a measurement system that can precisely measure a third harmonic component being at least five orders lower than the excitation signal. Thus, varistors quality can be assessed by linearity of their DC characteristics in this pre-breakdown voltage range (Fig.15).

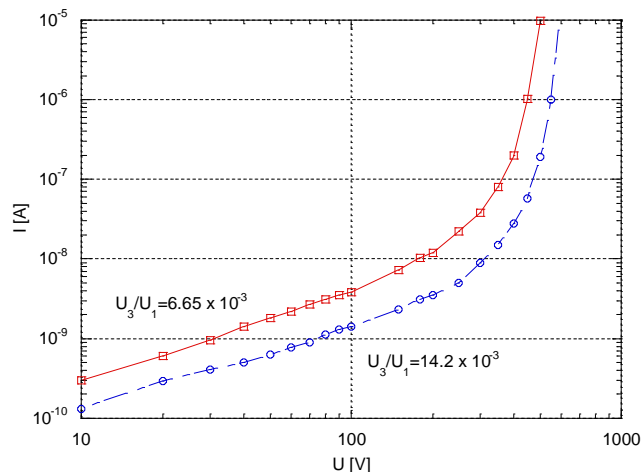

Fig. 15. DC characteristic of two varistors, series 280V – poor quality (squares) and high quality (circles) – and their normalized third harmonic component U_3 measured at amplitude $U_1=100 \text{ V}$ of the excitation signal

The exponential dependence between the excitation signal U_1 and the measured third harmonic component U_3 was observed. Varistors from the high quality batches exhibited on average slightly lower exponent around 2 when compared with the results observed in the poor quality batches. This outcome is in a good agreement with the observed differences in DC current-voltage characteristics for both types of batches. A more linear DC characteristic at low voltage range for the poor quality batch means lower THI component that begins to rise faster (higher exponent) when compared with behaviour observed for high quality specimens. At the next step, the measurements were carried out within a set of about hundred specimens for each batch of samples. The exemplary statistical data for the series 440 V and the amplitude $U_1=100 \text{ V}$ of the applied sinusoid has been shown in Fig. 16.

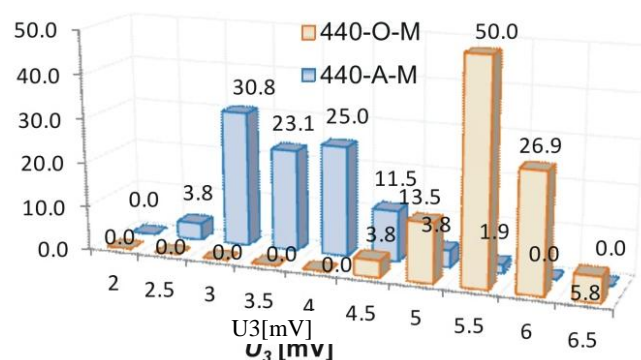

Fig.16. Percentage distribution of third harmonic component U_3 observed at excitation signal with amplitude $U_1=100 \text{ V}$ for poor (A-M) and high quality (O-M) varistors from series 440 V.

A more linear DC characteristic at low voltage range for poor quality varistors means lower third harmonic component that begins to rise faster (higher exponent) when compared with behaviour observed for high quality specimens. The high quality elements exhibit on average significantly higher third harmonic component value.

7. CONCLUSION

Non-destructive methods of varistor quality and endurance testing could be successively applied for varistor specimens at the production stage and after it. The method rely on the acoustic emission signal analysis could also be taken into account [11], similarly as an impedance spectroscopy.

For the RUS method a full separation between good and defected samples has been achieved.

These NDT methods can be applied for quality detection of other, especially grainy, materials. Unfortunately, noise spectroscopy [9] is a very time consuming method and because of interferences in an industry environment could be applied only in the laboratory researches.

ACKNOWLEDGMENT

The research was partially financed by the Polish Ministry of Science and Higher Education (2010/2011), project No. N N511 304338, and by the Czech-Polish project MEB 051003.

8. BIBLIOGRAPHY

1. Hasse L., Konczakowska A., Smulko J.: Classification of high-voltage varistors into groups of differentiated quality, *Microelectronics Reliability*, No. 12 (49), 2009, pp. 1483–1490, ISSN 0026-2714.
2. Hasse L., Spiralski L., Šikula J.: Nonlinear ultrasound spectroscopy as a information-diagnostic tool (in Polish), *Scientific Annals of Faculty of Electronics, Telecommunications and Informatics Gdansk University of Technology*, vol. 14, 2007, pp. 683-688, ISBN 978-83-60779-01-9.
3. Hasse L., Smulko J.: Diagnostics of high-voltage varistor quality using resonant ultrasound spectroscopy, *Proc.*

- Electronics Devices and Systems: IMAPS CS Intern. Conference EDS'08, Brno, Czech Republic, 10-11 September 2008, pp. 485-490, ISBN 978-80-214-3717-3.
4. Hasse L., Kiwilszo M., Smulko J., Stepinski T.: Quality assessment of varistor ZnO structures by resonant ultrasound spectroscopy, *Insight*, No. 5 (51), 2009, pp. 262-265, ISSN 1354-2575.
5. Migliori A., Sarrao J.L.: *Resonant Ultrasound Spectroscopy*, Wiley, 1997, ISBN-10: 0471123609.
6. Konczakowska A.: Methodology of semiconductor devices classification into groups of differentiated quality. *Microelectronics Reliability*, No. 1 (48), 2008, pp. 37-44, ISSN: 0026-2714.
7. Hasse L., Spiralski L., Sedlaková V., Šikula J.: Electro-ultrasonic spectroscopy of high-voltage varistors (in Polish), *Pomiary Automatyka Kontrola*, No. 3 (54), 2008, pp. 99-101, ISSN 0032-4140.
8. B. K. Jones B.K.: Electrical noise as a measure of reliability in electronic devices, *Advanced in Electronics and Electron Physics* no. 11 (67), 1994, pp. 201-257, ISBN 0-12-014729-7.
9. Hasse L., Smulko J.: Quality assessment of metal oxide varistors by noise spectroscopy, *XIX IMEKO World Congress: Fundamental and Applied Metrology*, 6-11 September 2009, Lisbon, Portugal. - Dane tekstowe / IMEKO. - Lisbon, 2009, pp. 1424-1427, ISBN 978-963-88410-0-1
10. Hasse L., Smulko J.: Quality assessment of high voltage varistors by third harmonic index, *Metrology and Measurement Systems*, No.1 (15), 2008, pp. 23-31, ISSN 0860-8229.
11. Hasse L., Smulko J., Kaczmarek L.: Diagnostics of high-voltage varistors by acoustic emission, *EWGAE 2010, Proc. 29th European Conference on Acoustic Emission Testing 2010, EWGAE 2010*, 8-10 September 2010, Vienna, Austria, 7 pp., ISBN 978-3-200-01956-0.

DIAGNOSTYKA WARYSTORÓW Z ZNO Z ZASTOSOWANIEM METOD NIENISZCZĄCYCH

Słowa kluczowe: warystor, diagnostyka, testowanie metodami nieniszczącymi

Streszczenie: Normatywne testy przemysłowe warystorów wysokonapięciowych stosowanych w ogranicznikach przepięć wymagają użycia wysokich napięć oraz prądów o odpowiednio dużych wartościach. Zaproponowano i opisano metody nieniszczące do oceny jakości i trwałości warystorów. Polegają one na zastosowaniu rezonansowej spektroskopii ultradźwiękowej, spektroskopii elektro-ultradźwiękowej, pomiarów szumów i testowaniu nieliniowości w zakresie napięć mniejszych od ciągłego napięcia pracy. Uzyskane wyniki wskazują, że metody nieniszczące mogą być z powodzeniem stosowane w odniesieniu do struktur warystorowych, zarówno w warunkach produkcyjnych jak i laboratoryjnych.